

SSC Request 1/20/76  
Item 3 (Re: Secret Army Organization)  
Volume III

Access

Released under the John F. Kennedy Assassination Records Collection Act of 1992  
(44 USC 2107 Note). Case#:NW 55000 Date: 11-17-2017



# Memorandum

TO : DIRECTOR, FBI (157-23577)

DATE: 3/11/75

FROM: SAC, MILWAUKEE (157-2445) (C)

SUBJECT: SECRET ARMY ORGANIZATION (SAO)  
EM

Reference Bureau letter to Milwaukee dated 12/19/74.

Enclosed for the Bureau are six copies of an LHM captioned as above which are self explanatory. Two copies of FD-376 are attached for the Bureau.

For the information of the Bureau, the following sources were contacted in the Madison area concerning captioned organization and JAMES PHILLIP WINKLER during the period from 11/1/74 up to 2/28/75:  
**INFORMANTS** The source contacted in the Milwaukee area was **INFORMANT**

A copy of enclosed LHM is being disseminated to Secret Service, Milwaukee.

Milwaukee has noted the other observations contained in referenced communication and these matters concerning WINKLER will be followed through Milwaukee file 157-916 which pertains to WINKLER.

In view of the information set forth, Milwaukee is not conducting any further investigation concerning captioned organization but will follow as noted above.

EX 104

REC-21 157-23577-105

ENCLOSURE

21 MAR 17 1975

- (2 - Bureau (157-23577) (Enc. 6) (RM)
- 4 - Milwaukee
  - 1 - 157-2445
  - 1 - 157-916
  - 1 - 157-76
  - 1 - 7-590

FIVE

HWC/jma 155/ccd/ss/2-D  
(6)

51 APR 03 1975 4-1-75

174

Buy U.S. Savings Bonds Regularly on the Payroll Savings Plan



5010-108-02



FEDERAL BUREAU OF INVESTIGATION

WASHINGTON, D.C. 20535

March 11, 1975

Director  
United States Secret Service  
Department of the Treasury  
Washington, D. C. 20220

In Reply, Please Refer to  
File No. MI 157-2445

RE: SECRET ARMY ORGANIZATION

Dear Sir:

The information furnished herewith concerns an individual or organization believed to be covered by the agreement between the FBI and Secret Service concerning protective responsibilities, and to fall within the category or categories checked.

- 1.  Threats or actions against persons protected by Secret Service.
- 2.  Attempts or threats to redress grievances.
- 3.  Threatening or abusive statement about U. S. or foreign official.
- 4.  Participation in civil disturbances, anti-U. S. demonstrations or hostile incidents against foreign diplomatic establishments.
- 5.  Illegal bombing, bomb-making or other terrorist activity.
- 6.  Defector from U. S. or indicates desire to defect.
- 7.  Potentially dangerous because of background, emotional instability or activity in groups engaged in activities inimical to U. S.

Photograph  has been furnished  enclosed  is not available.

Very truly yours,

*Clarence M. Kelley*  
Clarence M. Kelley  
Director

1 - Special Agent in Charge (Enclosure(s)) (1)  
U. S. Secret Service , Milwaukee (RM)

Enclosure(s)



FEDERAL BUREAU OF INVESTIGATION

In Reply, Please Refer to  
File No.

Milwaukee, Wisconsin

March 11, 1975.

SECRET ARMY ORGANIZATION (SAO)

Confidential sources in the Madison and Milwaukee, Wisconsin areas who are familiar with the activities of extremist organizations and individuals who participate in these organizations, whose philosophies espouse, what is known as extremely "right wing" philosophies, advise that they were not familiar with any Secret Army Organization (SAO) (a characterization of which is attached hereto) and the National Socialist White Peoples Party (NSWPP) (see Appendix). Those sources in the Madison area advised that they were not familiar with James Phillip Winkler or the SAO. Those sources in the Milwaukee area advised that they were familiar with the NSWPP but were not acquainted with Winkler as an active member of that organization.

This document contains neither recommendations nor conclusions of the FBI. It is the property of the FBI and is loaned to your agency; it and its contents are not to be distributed outside your agency.

157-23577-1-5

ENCLOSURE

SECRET ARMY ORGANIZATION (SAO)

SECRET ARMY ORGANIZATION (SAO)

The Secret Army Organization (SAO) was an anti-communist, paramilitary organization formed in San Diego, California, in 1971. Its objectives were to conduct intelligence-type operations and to offer training in urban guerrilla warfare to be used against "left-wing groups" and suspected enemies of the United States. SAO members in the San Diego area involved themselves in a number of incidents of violence resulting in their arrest and incarceration on local charges, including attempted murder, illegal possession of explosives, and receiving stolen property. The SAO was reported defunct in October, 1972.

APPENDIX

NATIONAL SOCIALIST WHITE PEOPLE'S PARTY (NSWPP)  
Also Known As, THE AMERICAN NAZI PARTY,  
AMERICAN NAZIS,  
THE WORLD UNION OF FREE ENTERPRISE NATIONAL SOCIALISTS,  
THE GEORGE LINCOLN ROCKWELL PARTY

---

The American Nazi Party - The World Union of Free Enterprise National Socialists was organized by George Lincoln Rockwell on February 26, 1956, based upon the concept of an international "National Socialist" movement, as espoused by the German Nazi Party, which was headed by Adolf Hitler. On January 1, 1957, the official name of this organization was changed to National Socialist White People's Party. The NSWPP supports and follows the line of hatred against blacks, Jews and communists through various propaganda media, demonstrations, and other publicity-seeking devices for the purpose of seeking a legitimate dominant political party within the United States and in foreign countries. Headquartered in Arlington, Virginia, the NSWPP is currently led by Matthias Koehl, Jr.

APPENDIX

# Memorandum

TO : DIRECTOR, FBI

FROM : SAC, MILWAUKEE (157-916) (P)

SUBJECT: CHANGED  
 JAMES PHILLIP WINKLER  
 EM - NSWPP

OO: MILWAUKEE

DATE: 1/8/75

9

Title marked changed to reflect middle name of subject.

Re Milwaukee letter to the Bureau, dated November 1, 1974, captioned "RICK MANDELL, EM"; and Bureau airtel to Milwaukee, dated December 3, 1974, captioned "JAMES P. WINKLER, EM - NSWPP."

Referenced airtel questioned the basis for Milwaukee's investigation of MANDELL. The following information is being set forth to clarify Milwaukee's interest in MANDELL:

Milwaukee LHM, dated September 28, 1973, captioned "Secret Army Organization (SAO)" set forth information furnished by the Jefferson County Sheriff's Office, Jefferson, Wisconsin, which indicated that RICK MANDELL could be a possible suspect in the SAO investigation. MANDELL's whereabouts at the time, were unknown.

Bureau telephone call to Milwaukee, on August 22, 1974, requested a preliminary inquiry be instituted to identify MANDELL.

On October 22, 1974, JAMES PHILLIP WINKLER was arrested by the Madison, Wisconsin Police Department, while acting suspiciously outside the Madison, Wisconsin City Council Chambers. He was

- 4 - Bureau (RM)
  - (2 - JAMES PHILLIP WINKLER)
  - (1 - RICK MANDELL)
  - (1 - SAO 157-23577)
- 6 - Milwaukee
  - (3 - 157-916)
  - (1 - 157-2801)
  - (1 - 157-2445)
  - (1 - 7-590)

157-23577-

NOT RECORDED  
 100 JAN 13 1975

ORIGINAL FILED IN 157-33701-1

70 JAN 13 1975 JSM/rah  
 5010-110

(10) Buy U.S. Savings Bonds Regularly on the Payroll Savings Plan



charged with "bomb scare" and "attempt to endanger life by conduct regardless of rights."

Items found in the possession of WINKLER, at the time of his arrest, and in the subsequent search of his room at the YMCA, Madison, Wisconsin, led Madison, Wisconsin Police Department officers to believe that WINKLER was in fact, the SAO.

The above information is set forth in Milwaukee letter and LHM, dated November 25, 1974, captioned "SAO."

Milwaukee had never developed any positive link between MANDELL and the SAO, and in view of the literature found in the possession of WINKLER, Milwaukee felt no further investigation was warranted regarding MANDELL.

On January 3, 1975, Detective ALBERT ROEHLING, Madison, Wisconsin Police Department, advised that on October 31, 1974, WINKLER had been committed to the University of Wisconsin Hospital, Madison, Wisconsin, for psychiatric examination, and has since been found competent to stand trial for the above charges.

He was subsequently released to the custody of his parents, Mr. & Mrs. EDWARD WINKLER, Watertown, Wisconsin, pending trial.

ROEHLING stated that the literature found in the possession of WINKLER, and in his room, which was not needed in court, had been turned over to his parents. He has no idea as to what the final disposition his parents had made of the literature.

Milwaukee will report WINKLER's prosecution under the case entitled "JAMES PHILLIP WINKLER; PAUL RICHARD SOGLIN; JAMES EVERETT ROWEN; SUSAN JEAN MC GOVERN - VICTIM; KIDNAPPING," Bureau file 7-15695, Milwaukee file 7-590.

LEADS

MILWAUKEE DIVISION

At Watertown, Wisconsin

1. Will conduct criminal checks regarding WINKLER.
2. Interview WINKLER concerning his knowledge of the SAO, and/or the NSWPP, in the Madison, Wisconsin area.

At Madison, Wisconsin

Following the results of local disposition at Madison, Wisconsin, and investigation at Watertown, Wisconsin, will evaluate subject as a potential bombing suspect, make ADEX recommendations, and submit an investigative summary.

(Attn: Mr. E. Anthony)...

1 - Milwaukee Guidance

1 - Mr. T. F. Patrick

12/19/74

SAC, Milwaukee (157-2445)

Director, FBI (157-23577) **104**

REC-311

SECRET ARMY ORGANIZATION (SAO)

EM; EXTORTION

ReMillet and LEM 11/25/74.

Milwaukee should promptly forward copy of referenced LEM to Secret Service locally. Subsequent communications prepared in a form suitable for dissemination regarding captioned matter should also be provided to Secret Service locally.

MAILED 4  
DEC 18 1974  
FBI

Review of investigation conducted regarding the possible existence of a Secret Army Organization (SAO) in the Milwaukee Division fails to reveal that appropriate extremist and security sources have been contacted recently regarding this matter and, in particular, since James Phillip Winkler was identified in October, 1974, as an apparent SAO activist, possibly self-appointed, in the Milwaukee Division territory. Since referenced LEM reports Winkler is also apparently a National Socialist White Peoples Party (NSWPP) member in Milwaukee, Wisconsin, insure that logical informants in Madison and Milwaukee are contacted regarding SAO and Winkler. Pertinent results should be submitted in form suitable for dissemination.

It is noted that a police search of Winkler's room conducted with his consent following his arrest 10/23/74, revealed an index of numerous individuals involved in political activities considered to be either left or right wing, with news clippings, appropriate to each, filed in an

- Assoc. Dir. \_\_\_\_\_
- Dep. AD Adm. \_\_\_\_\_
- Dep. AD Inv. \_\_\_\_\_
- Asst. Dir.:
- Admin. \_\_\_\_\_
- Comp. Syst. \_\_\_\_\_
- Ext. Affairs \_\_\_\_\_
- Files & Com. \_\_\_\_\_
- Gen. Inv. \_\_\_\_\_
- Ident. \_\_\_\_\_
- Inspection \_\_\_\_\_
- Intell. \_\_\_\_\_
- Laboratory \_\_\_\_\_
- Plan. & Eval. \_\_\_\_\_
- Spec. Inv. \_\_\_\_\_
- Training \_\_\_\_\_
- Legal Coun. \_\_\_\_\_
- Telephone Rm. \_\_\_\_\_
- Director Sec'y \_\_\_\_\_

TF: bkb/j  
(6)

RDS/TF

SEE NOTE PAGE 3

7 DEC 31 1974

MAIL ROOM TELETYPE UNIT

Letter to Milwaukee  
Re: SECRET ARMY ORGANIZATION (SAO)  
157-23577

envelope behind each name in the index. Also found was a leaflet bearing a stamped notation which included in part the entry "SAO, White Legion Division." Also found was considerable correspondence between Winkler and the Christian Anti-Communist Crusade, Box 890, Long Beach, California.

Bureau files reveal that as of June, 1973, the Christian Anti-Communist Crusade is an organization directed by Dr. Fred Schwartz, an Australian medical doctor who moved to this country in 1933. Published reports indicated this organization takes a somewhat extreme view against communism. No investigation has been conducted by the FBI concerning this organization.

You should review pertinent correspondence between Winkler and the Christian Anti-Communist Crusade and if any information of an extremist nature is noted, insure that the Bureau and the Los Angeles Division are promptly advised.

Also review all pertinent material and publications in possession of local police which were possibly obtained from Winkler, or his possessions, in search of any additional information of intelligence value based on FBI jurisdiction.

It is noted that following a local hearing 10/31/74, Winkler was sent for a 60-day period of psychiatric evaluation at University Hospital, Madison, Wisconsin. Milwaukee should insure consideration is given to interviewing subject to fully resolve whether SAO in Wisconsin consists entirely of Winkler or whether others are involved. No interview should be attempted until Winkler's psychiatric status is resolved and appropriate local prosecuting attorney advises FBI interview will not jeopardize any pending prosecution.

Letter to Milwaukee  
Re: SECRET ARMY ORGANIZATION (SAO)  
157-23577

If any aspects of investigation regarding SAO and/or Winkler constitute, or possibly constitute, an Extortion violation, promptly present matter to appropriate U. S. Attorney for prosecutive opinion. Advise FBIHQ promptly of any pertinent action taken in this regard.

NOTE:

Numerous typed threatening-type anonymous letters were sent to various newspapers and officials in the Madison, Wisconsin, area over the past year. Some of the letters were signed "S/O." James Phillip Winkler, a 27-year-old white male was detained by Madison police following his suspicious actions outside a Madison City Council meeting 10/22/74. A written threat had been received earlier that a bomb would possibly go off at this meeting. At the time of his detention Winkler had in his possession a shoe box containing a notebook with diary-type entries as well as several paperback books, including one entitled "Bomber." The diary-type entries indicate Winkler is possibly insane and would try to kill somebody or himself. On 10/23/74 he was charged with "Bomb Scare" and "Attempt to Endanger City by Conduct Regardless of Life."

Extortion aspects of this matter were coordinated with Supervisor Elroy Anthony, General Investigative Division.

Bombing aspects of this matter were previously coordinated with CI-3 Section and instructions sent to Milwaukee in Bureau airtel, 12/3/74, captioned "James P. Winkler, E1 - NSWPP."

# Memorandum

DIRECTOR, FBI (157-23577)

DATE: 11/25/74

TO : SAC, MILWAUKEE (157-2445)(C)

~~REC.~~

SUBJECT: SECRET ARMY ORGANIZATION  
EM-EXTRITION  
OO: Milwaukee

Re Milwaukee airtels to Bureau, 9/28/73 and 4/17/74; Milwaukee letter to the Bureau, 8/5/74 with enclosed LHMs. Reference is also made to Milwaukee airtel to Bureau and subsequent LHM in matter captioned "JAMES PHILIP WINKLER; PAUL RICHARD SOGLIN; JAMES EVERETT ROWEN; SUSAN JANE MC GOVERN - VICTIMS - KIDNAPING," OO Milwaukee, MI 7-590.

Enclosed to the Bureau is an LHM which is self-explanatory and suitable for dissemination. No copy of instant LHM is being disseminated to U. S. Secret Service, Milwaukee, as a LHM concerning WINKLER was disseminated to Secret Service under caption of referenced kidnaping file.

Milwaukee is closing its matter in captioned case as there is sufficient evidence to show that JAMES PHILLIP WINKLER, working alone, is, in fact, the Secret Army Organization operating in Madison, Wisconsin, since September, 1973.

*RD*  
*ca*

- 2 - Bureau (Encs.-6) (RM)
- 3 - Milwaukee (1 - 157-2445)
  - (1 - 100-14900 - PAUL R. SOGLIN)
  - (1 - 100-16817 - JAMES ROWEN)

HWC:jl  
(5)

REC-89 157-23577-104

1cc - CD(CCS)  
1cc - CD(CSS)  
1cc - CRD  
1cc - S  
1cc - 40843FH  
TF/RJA 12/11/74

EX-117 DEC 2 1974

RES 1  
FIVE

*6- [Signature]*

Buy U.S. Savings Bonds Regularly on the Payroll Savings Plan



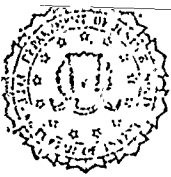

UNITED STATES DEPARTMENT OF JUSTICE

FEDERAL BUREAU OF INVESTIGATION  
Milwaukee, Wisconsin  
November 25, 1974

Reply, Please Refer to  
File No.

SECRET ARMY ORGANIZATION  
EXTREMIST MATTER; EXTORTION

On October 15, 1974, a typewritten anonymous letter was received at the Federal Bureau of Investigation (FBI) Office, 3610 University Avenue, Madison, Wisconsin, which advised that the writer had learned of plans "over the week end" to kidnap or assassinate someone in the Madison Mayor's Office. The letter further stated that the intended victim could be either Mayor Paul R. Soglin or his assistant, James Rowen, or Rowen's wife, Susan Rowen Mc Govern, daughter of U. S. Senator George Mc Govern (D-S.D.). The letter stated that this action would take place later in the week (either October 17 or 18, 1974). The envelope was postmarked "U.S. Postal Service 535 OCT 14 1974 P.M." and was addressed "Agent in Charge, Madison FBI, 3610 University Av. Madison, Wisconsin." It was further marked "Confidential - OPEN AT ONCE."

This information was immediately disseminated to the Office of the Mayor and the Madison Police Department. No incidents occurred over the week end of October 19-20, 1974.

On the afternoon of October 22, 1974, the day of the regularly scheduled Madison City Council meeting, a typewritten envelope addressed "MADISON NEWSPAPERS INC. - DELIVER TO PAUL SOGLIN, MAYOR'S OFFICE" was found in a men's rest room on the third floor of the City-County Building, and was delivered to the Mayor's Office, located on the fifth floor by an unknown white male. In the lower left-hand corner was the instruction "OPEN AT ONCE." Inside was a typewritten unsigned letter stating "DO NOT ATTEND TONIGHT'S COUNCIL SESSION."

This document contains neither recommendations nor conclusions of the FBI. It is the property of the FBI and is loaned to your agency; it and its contents are not to be distributed outside your agency.

157-23377-104  
ENCLOSURE

THERE COULD BE A BIG BANG. YOU HAVE BEEN WARNED. THIS IS NO JOKE. "DON'T BE THERE."

As a result of this letter, the Madison Police Department searched the Council chambers prior to their meeting and found nothing. Plain-clothes police officers were stationed outside the Council chambers to be alert for suspicious persons.

James Phillip Winkler, white male, born May 17, 1947 at Watertown, Wisconsin, was observed acting suspiciously outside the Council chambers, and he was observed to be carrying a wrapped shoe box. Winkler was stopped and questioned outside the City-County Building, and he voluntarily returned to the Police Department for interview.

Located on his person was a three-ring notebook that contained handwritten diary-like notations. The entries were dated from January 5, 1974 through October 20, 1974. The shoe box contained several paper back books. It was noted that the top one was entitled "Bomber."

The notebook was reviewed by Detective Albert Roehling, Madison Police Department. He stated that in entries beginning with October 9, 1974, Winkler wrote that he thought he was going "mad," and he did not know what to do about it. Under date of October 17, 1974, Winkler writes that he thinks he could become a full-fledged assassin. He further writes: "I'm starting to believe my own fantasies and it's a little..... Tuesday night I actually believed I was out to kill Soglin. How easy access is to the man. I was behind him a couple of times. How easy it would have been. Just stick him and it would be all over. It scares me. I don't want to kill anybody but my fantasies are coming to the forefront. I might try it while not realizing what I am doing."

The entry further states that if he (Winkler) was not so afraid to die, he would kill himself. He further states in an entry "Oct. 17 PM" that he feels he is turning into a full-fledged assassin and he wonders if this is how Oswald (Lee Harvey) and Bremer (Arthur) fell into murder.



ORGANIZATION  
EXTREMIST MATTER; EXTORTION

The October 18, 1974 entry asks why Winkler has not been arrested. He further states he does not feel he is in full control of himself.

Roehling advised that Winkler, on October 23, 1974, was charged with violations of Wisconsin Statutes, Section 947.15 "Bomb Scare," and Sections 941.30 and 939.32 "Attempt to Endanger Safety by Conduct Regardless of Life." On October 31, 1974, a hearing was held and Winkler was sent to University Hospitals, Madison, Wisconsin, for psychiatric evaluation. There have been no results furnished at this time as the evaluation will cover a period of at least sixty days.

Roehling further advised that based on a consent to search from Winkler, his room at the YMCA, 207 W. Washington Avenue, Madison, produced numerous cardboard boxes containing index cards, manila folders and books of all descriptions. The index cards in the boxes and file drawers contained names of numerous individuals, that is, Paul Soglin, James Rowen, Joan Baez and other personalities, both nationally known and of the Madison area. Review of these names indicated that they were all involved in political activity considered under the categories of left and right wing. These cards contained bits of information on each individual, quoting statements made in speeches or interviews to the press. The manila folders were indexed to individuals and organizations that contained newspaper clippings concerning these individuals. There was no folder located entitled "Secret Army Organization," (See Appendix) nor was there any correspondence connecting Winkler with the Secret Army Organization known to have existed in San Diego, California.

SECRET ARMY ORGANIZATION  
EXTREMIST MATTER; EXTORTION

Among the numerous items was a leaflet entitled "Details How to Ship Negroes Back to Africa," authored by Drew L. Smith and distributed by the National States Rights Party (see Appendix), P. O. Box 1211, Marietta, Georgia. It was noted that across the top of each of these leaflets was the typewritten inscription "DISTRIBUTED IN THE SOUTHERN WISCONSIN AREA BY: S.A.O. \*\*\*\*WHITE LEGION DIVISION."

A similar leaflet was recovered on a bulletin board located in the Vilas Communications Building, University of Wisconsin, Madison, in March, 1974 by Mike Fellner, editor of "Take-Over," an underground newspaper in Madison. This leaflet was turned over to agents of the FBI by Fellner in June, 1974. It was noted that most correspondence Winkler had was with the Christian Anti-Communist Crusade, Box 890, Long Beach, California. Roehling also advised that most of the tear-out sheets located in the manila folders were from the publication "Christian Crusade Weekly," which is published by the Christian Anti-Communist Crusade.

Roehling also advised that located in Winkler's room was an SCM portable manual typewriter. Samples were taken from the typewriter by Roehling and he requested a preliminary opinion from Sergeant Robert Schunk, Dane County Sheriff's Office, Document Examiner, who, in his preliminary statement, stated that there were numerous similarities of letter characteristics in the recent letters received by the Police Department and the samples taken from the typewriter. Roehling advised that there was no complete admission by Winkler that he was, in fact, the author of numerous correspondence received during the period September, 1973 to October, 1974 that was signed "SAO." Roehling expressed the opinion

SECRET ARMY ORGANIZATION  
EXTREMIST MATTER; EXTORTION

based on the evidence found in Winkler's room, the comparison of Winkler's handwriting in the notebook recovered from him at the time of original detention with the materials accumulated over the period of the past year that there can be deduced a strong opinion that Winkler is, in fact, the SAO in Madison. Roehling further stated that it appears that Winkler operated as a lone individual as they cannot locate any individuals with whom he has associated. Roehling further advised that when Winkler was arrested, contained in his wallet was a membership card for the National Socialist White People's Party (See Appendix), Milwaukee, Wisconsin.

Review of the Watertown, Wisconsin Police Department files shows that Winkler, on May 12, 1966, was charged with six counts of arson. He pled guilty and was sentenced to three years at the Green Bay Reformatory (no date of sentencing recorded).

The following is a description of Winkler:

Name	JAMES PHILLIP WINKLER
Race	White
Sex	Male
Birth Data	5/17/47
Height	Watertown, Wisconsin
Weight	5'8"
Eyes	275
Hair	Blue
Characteristics	Brown
Relatives	Glasses
	Father - Richard Winkler, born 6/19/21;
	Mother - Dolores A. Winkler, born 6/15/22 -
	415 N. 4th Street, Watertown, Wisconsin
Brother	Edward Winkler, Watertown, Wisconsin
Identification Numbers	Watertown, Wis. PD #20475; Madison, Wis. PD #B43780
Fingerprint Class.	16 M 1 Rt 15 S 1 R

APPENDIX

SECRET ARMY ORGANIZATION(SAO)

The Secret Army Organization was an anti-communist, para-military organization formed in San Diego, California in 1971. Its objectives were to conduct intelligence-type operations and to offer training in urban guerrilla warfare to be used against "left wing" groups and suspected enemies of the U.S. SAO members in the San Diego area involved themselves in a number of incidents of violence, resulting in their arrest and incarceration on local charges, including attempted murder, illegal possession of explosives and receiving stolen property. The SAO was reported defunct in October, 1972.

APPENDIX

-6-

APPENDIX

NATIONAL STATES RIGHTS PARTY

The National States Rights Party (NSRP), formerly known as the United White Party, was organized in 1957 in Knoxville, Tennessee. The NSRP's official party line promotes hatred against Jews, Negroes, Communists and certain law enforcement agencies. NSRP National Chairman J. B. Stoner has publicly advocated killing or deporting Jews; deportation of Negroes; "doing away with FBI pimps," and repeal of all civil rights laws. The NSRP carries out its line of hatred through the use of propaganda media and provocative demonstrations.

APPENDIX

APPENDIX

NATIONAL SOCIALIST WHITE PEOPLE'S PARTY (NSWPP)  
also known as THE AMERICAN NAZI PARTY, AMERICAN  
NAZIS, THE WORLD UNION OF FREE ENTERPRISE  
NATIONAL SOCIALISTS, THE GEORGE LINCOLN  
ROCKWELL PARTY

The American Nazi Party - The World Union of Free Enterprise National Socialists was organized by George Lincoln Rockwell on February 26, 1956, based upon the concept of an international "National Socialist" movement, as espoused by the German Nazi Party which was headed by Adolf Hitler. On January 1, 1967, the official name of this organization was changed to National Socialist White People's Party. The NSWPP supports and follows the line of hatred against blacks, Jews and communists through various propaganda media, demonstrations, and other publicity-seeking devices for the purpose of seeking a legitimate dominant political party within the United States and in foreign countries. Headquartered in Arlington, Virginia, the NSWPP is currently led by Matthias Koehl, Jr.

APPENDIX

-8\*

# Memorandum

TO : DIRECTOR, FBI (157-23577)

DATE: 8/5/74

FROM : SAC; MILWAUKEE (157-2445) (P)

SUBJECT: SECRET ARMY ORGANIZATION (SAO)  
EXTREMIST MATTER - EXTORTION

*DeP...*

Re Milwaukee airtel to the Bureau dated 4/17/74, enclosing LHM dated 4/17/74.

Enclosed for the Bureau are six Xerox copies of an LHM dated and captioned as above, which is self-explanatory.

After receipt of notebook from MARK MC ELREATH, MIKE FELLNER was located on 6/12/74 and advised of the contents. The Madison Police Department was also advised of the contents of the notebook.

Based on investigation set forth in LHM, the following investigation is being conducted at Madison, Wisconsin:

Will submit to Document Section, FBI Laboratory, letter of 3/25/74, signed by RALPH L. KREUGER. Will also submit for handwriting comparisons notebook located on 6/11/74 at UW - Madison, along with notebook located in City County Building on 10/2/73.

Investigation will continue in an effort to identify RALPH L. KREUGER.

01 8/11-15-74

ENCLOSURE

REC-85

*6/2/74*

- 2 - Bureau (Enc. 6) (RM)
- 5 - Milwaukee
  - (2 - 157-2445)
  - (2 - 100-17583) (MIKE FELLNER)
  - (1 - 100-15252) (YAWF)

157-23577-103

HWC:lrh 2cc-CD (ISS-SLU)  
(7)

AUG 9 1974

1cc-CRB  
1cc-SS  
1cc-618 qtd  
TF/RSG 8/14/74

*H. Boyd*

*Out...*



Buy U.S. Savings Bonds Regularly on the Payroll Savings Plan



## UNITED STATES DEPARTMENT OF JUSTICE

## FEDERAL BUREAU OF INVESTIGATION

Reply, Please Refer to  
File No.

Milwaukee, Wisconsin

August 5, 1974

SECRET ARMY ORGANIZATION

On June 11, 1974, Mark Mc Elreath, 818 Terry Place, Madison, Wisconsin, an employee of Station WHA-TV located in the Vilas Communications Building, University of Wisconsin (UW) - Madison, turned over a blue spiral notebook he had found in an elevator at his place of employment on that date. The notebook contained numerous handwritten notes concerning individuals and organizations identified with the "New Left" political activities in the Madison and Milwaukee, Wisconsin, areas. The first page indicated that the unknown writer was making plans pertaining to an attempted kidnaping of Mike Fellner, editor of the underground Madison newspaper "Takeover." The notes indicated that the contemplated action was to take place between June 15-16, 1974. Fellner, according to the notes, was believed to be the son of a Carl N. Fellner, a professor of (psychiatry) at UW. Fellner in an interview on June 13, 1974, identified his father as Werner Fellner, owner of a garage and who resides in Philadelphia, Pennsylvania. Carl H. Fellner was last listed in the 1972-1973 UW Staff Directory.

Fellner at time of interview also furnished a typewritten letter dated March 25, 1974, signed Ralph L. Kreuger. Kreuger relates in the letter to "our extortion" and further relates to letters addressed to certain advertisers of "Takeover" that were found on March 5, 1974, in the newspaper rack at the UW Memorial Student Union. These letters were turned over to the Madison Police Department, who have submitted them to the FBI Laboratory for examination.

The notebook also eludes to other proposed actions against "New Left" organizations. One such entry concerns a "smashing victory" concerning the Youth Against War and

This document contains neither recommendations nor conclusions of the FBI. It is the property of the FBI and is loaned to your agency; it and its contents are not to be distributed outside your agency.

157-23577-103

ENCLOSURE



## SECRET ARMY ORGANIZATION

Fascism (YAWF), 150 East Juneau, Milwaukee. It is known that unknown individuals did break into the offices of this organization in May, 1974; but the incident was not reported to the Milwaukee Police Department.

### YOUTH AGAINST WAR AND FASCISM

YAWF is the youth group of the Workers World Party (WWP).

### WORKERS WORLD PARTY

The WWP was founded in 1959, by individuals who disagreed with policies of the Socialist Workers Party (SWP). The WWP dissidents advocated unconditional support of the Soviet Union and the building of a revolutionary party geared to the overthrow of capitalism. More recently, the WWP has called for peaceful solutions to Sino-Soviet border disputes; however, the WWP generally supports the People's Republic of China in its ideological differences with the Soviet Union.

### SOCIALIST WORKERS PARTY

The SWP, headquartered in New York City, is a revolutionary, Trotskyist-communist organization which has as its purpose the overthrow of the United States Government, the institution of a dictatorship of the working class and the eventual achievement of a communist society. SWP was founded in the United States in 1938 as the American section of the worldwide Trotskyist revolutionary organization named the Fourth International (FI), which is headquartered in Europe. In 1940, SWP withdrew its formal affiliation with the FI to escape application of the Voorhis Act,

## SECRET ARMY ORGANIZATION

which regulates certain types of organizations subject to foreign control. From 1970 to the present time, however, SWP has continued a close association with the FI and participates and votes as a "sympathizing group" in FI meetings.

While the SWP does not openly advocate the use of violence at the present time to overthrow the United States Government, the SWP believes that eventual violent revolution in the United States is inevitable. SWP seeks to precipitate revolution when conditions are ripe and to direct and seize control of the revolution when it occurs.

Importantly, the FI at its World Congress in Europe in 1974 took a position favoring the current use of guerrilla warfare and armed struggle to achieve revolution in South America and elsewhere if local conditions indicate that such violence would enhance revolution. A majority of the SWP delegation to the FI opposed the current use of violence only on the ground that it is premature whereas a minority of the SWP delegation favored the FI endorsement of violence.

### FOURTH INTERNATIONAL

The FI was founded in 1938 at Paris, France, embodying the ideological position of Leon Trotsky of "continuing revolution" in the application of Marxism. The FI is the largest Trotskyist group with worldwide representation. The SWP, a United States based Trotskyist group, participates in FI activities and leads a faction of the FI. The dominant faction of the FI, in February, 1974, took the position of

SECRET ARMY ORGANIZATION

favoring the current use of guerrilla warfare and armed struggle to achieve a revolution in Latin America if local conditions indicate that such violence would enhance the revolution.

A check of records of Madison law enforcement agencies, credit bureau, and UW were negative concerning Ralph L. Kreuger.

SECRET ARMY ORGANIZATION

The Secret Army Organization (SAO) was an anti-communist, paramilitary organization formed in San Diego, California, in 1971. Its objectives were to conduct intelligence-type operations and to offer training in urban guerrilla warfare to be used against "left-wing groups" and suspected enemies of the United States. SAO members in the San Diego area involved themselves in a number of incidents of violence resulting in their arrest and incarceration on local charges, including attempted murder, illegal possession of explosives, and receiving stolen property. The SAO was reported defunct in October, 1972.

FBI

Date: April 17, 1974

Transmit the following in \_\_\_\_\_  
(Type in plaintext or code)

Via AIRTEL AIR MAIL - REGISTERED  
(Priority)

TO: DIRECTOR, FBI (157-23577)  
FROM: SAC, MILWAUKEE (157-2445) (P)  
SUBJECT: SECRET ARMY ORGANIZATION (SAO)  
MILWAUKEE DIVISION  
EXTREMIST MATTER;  
EXTORTION

(OO: MILWAUKEE)

Re Milwaukee airtel and LHM to Bureau dated  
9/28/73;  
San Diego airtel to Bureau dated 10/31/73.

Enclosed for the Bureau are six (6) Xerox copies  
of an LHM dated and captioned as above, which is self-explanatory.

Milwaukee Division, at Madison, Wisconsin, will  
continue efforts to identify senders of letters to adver-  
tisers of "Takeover" newspaper to determine if they are  
the senders of the original letter and follow up results  
of FBI Laboratory examinations on letters submitted by  
the Madison Police Department.

LEAD

MILWAUKEE DIVISION

AT JEFFERSON, WISCONSIN

Will continue efforts to locate and interview  
RICK MANDELL re his efforts to form a guerrilla-type or-  
ganization.

157-23577-102

REC-30

3 - BUREAU (157-23577) (Encls. 6) (AM) (RM)  
2 - MILWAUKEE (157-2445)  
HHC/dgl  
(5)

12 APR 22 1974

EXCLUDED

HIVE

Approved: \_\_\_\_\_  
Special Agent in Charge

Sent \_\_\_\_\_ M Per \_\_\_\_\_

U.S. Government Printing Office: 1972 - 555-574

Dept. - /AC Civil Rights Div.  
AAC Criminal Div.  
Attn: JJJ

How forwarded R/S  
Date 4/24/74  
By

Milwaukee, Wisconsin

April 17, 1974

SECRET ARMY ORGANIZATION

For background purposes, a typewritten letter, undated, signed "Secret Army Organization" (SAO) was sent to the "Wisconsin State Journal," a Madison, Wisconsin daily newspaper, with the envelope bearing the postmark, "U. S. Postal Service - Watertown, WI - 9/17/73." The letter stated that action would begin in Madison against anti-American and anti-white organizations on September 17, 1973. The letter targeted Mayor Paul R. Soglin; Mel Cohen; and the Wisconsin Alliance, a small local political party. The Madison Police Department has been conducting investigation in connection with this letter but with negative results. The letter was submitted to the Federal Bureau of Investigation (FBI) Laboratory which identified the lettering as coming from either a Smith Corona typewriter or R. C. Allen standard typewriter.

SECRET ARMY ORGANIZATION

The SAO was an anti-communist, paramilitary organization formed in San Diego, California, in 1971. Its objectives were to conduct intelligence-type operations and to offer training in urban guerrilla warfare to be used against "left-wing groups" and suspected enemies of the United States. SAO members in the San Diego area involved themselves in a number of incidents of violence resulting in their arrest and incarceration on local charges, including attempted murder, illegal possession of explosives, and receiving stolen property. The SAO was reported defunct in October, 1972.

This document contains neither recommendations nor conclusions of the FBI. It is the property of the FBI and is loaned to your agency; it and its contents are not to be distributed outside your agency.

157-23577-102

ENCLOSURE

SECRET ARMY ORGANIZATION

Investigation at Watertown, Wisconsin, has been negative in identifying any individuals connected with any type of organization known as SAO. ROBERT T. WHITE, a former mayor, and DELVIN HINTZMANN, operator of the Watertown Cab Company and who employs many young persons as drivers, were unable to furnish any positive information concerning the activity of individuals who may have attempted to form an organization similar to SAO. Reviews of the "Watertown Daily Times," a local newspaper, did not reveal the identities of any individuals or organizations that could be considered connected with SAO. Records of the Watertown Police Department failed to disclose arrest or complaints or any other information of any individuals who could be connected to the SAO.

On March 5, 1974, the Madison Police Department received five typewritten letters from the circulation manager of the "Badger Herald," a student newspaper, University of Wisconsin (UW) - Madison, that were left on the news racks at the Student Memorial Union, UW - Madison. These letters were addressed to five advertisers whose advertisements appeared in "Takeover," a Madison underground newspaper. These letters were signed SAO. They advised that this was a warning against them. The letters stated that the latest issue of "Takeover" lavished praise on the Symbionese Liberation Army (SLA) and has endorsed Marxist terror. The letter stated that there would be a boycott by advertisers and that the addressees have no choice in taking part. The letters warned that if advertisers failed to remove all of their advertising from the next issue of "Takeover," SAO would be left with no choice but to take action to insure that advertisements would never be placed again. The letters warned that the advertisers had until the next issue to decide. The letters concluded that this was the first and only warning to be sent and that their futures in business depended on the advertisers' actions now. The advertisers receiving these letters were the Capitol and Majestic Theaters; Mid-West Hi-Fi; Cunique Billiards; and the Focal Point Co-op. The Madison Police Department is submitting these letters and envelopes to the FBI Laboratory for comparison examinations with the first letter received.

SECRET ARMY ORGANIZATION

Howard Barry Godfrey, San Diego, California, who is familiar with past activities of the SAO, advised on October 25, 1973, that he had no information regarding the SAO at Madison or any other city in Wisconsin. He was certain that there were no offshoot or related organizations with connections at San Diego in the Madison area at the time the SAO was active at San Diego. He opined that the person sending the threatening letters in Madison is not a San Diego resident since the writer appears to have knowledge of local political figures at Madison.

HOWARD BARRY GODFREY

Howard Barry Godfrey, for a number of years, voluntarily furnished information to the FBI regarding identities and activities of Extremist groups in the San Diego area. His information has been reliable and, as an interested citizen, he volunteered his knowledge and services to local law enforcement agencies which culminated in his appearance and testimony before the San Diego County Grand Jury in June and July of 1972.

- 1 - External Affairs Division
- 1 - Mr. D. W. Bowers
- 1 - Mr. H. A. McMan
- 2/7/74 1 - Mr. W. R. Wannall
- 1 - Mr. G. C. Moore
- 1 - Mr. P. E. Nugent
- 1 - Mr. F. A. Tansy
- 1 - Mr. T. Fitzpatrick

Mr. W. R. Wannall

G. C. Moore

THREE ANTI-FBI ARTICLES  
 APPEARING IN FEBRUARY, 1974, ISSUE OF  
 NATIONAL STATES RIGHTS PARTY (NSRP)  
 NEWSPAPER "THE THUNDERBOLT"  
 EXTREMIST MATTER - NSRP

Page 3 of the February, 1974, issue of "The Thunderbolt" (NS), a monthly newspaper of the NSRP, contains three articles critical of the FBI and, in part, of former Director J. Edgar Hoover. The NSRP is an antiblack, anti-Semitic, white racist political party headquartered in Marietta, Georgia, which is composed of past members of Klan-type organizations. It is edited by Dr. Edward R. Fields who is NSRP National Secretary.

The lead article is captioned "FBI Turned Into Secret Police." It discusses a lengthy written report allegedly given by former FBI Assistant to the Director William C. Sullivan to the White House, in which Sullivan "revealed" former Director Hoover "was not of sound mind in his last years"; how Director Hoover allegedly "kept files on Congressman and blackmailed them"; and how the FBI allegedly committed illegal acts in "prosecuting white patriots" for many years. The article alleges that former White House aide John Dean III gave a copy of Sullivan's report to the Senate Watergate Committee (SWC); however, the SWC has allegedly suppressed it. Readers are urged to write their Congressmen and the SWC demanding release of the "Sullivan Report."

The article further alleges the FBI has been "wrecking patriotic organizations" while only "giving lip service to the fight against communism," and has experienced a "loss of reputation."

Enclosures (3)

105-66222

1 - 157-17222 (Howard Godfrey)

1 - 157-23577 (SAP)

TF:lnk (12)

Enclosure

MAR 5 1974

CONTINUED - OVER

157-23577

NOV 20 1960

ORIGINAL FILED IN



Memorandum to Mr. W. R. Wannall  
Re: Three Anti-FBI Articles  
Appearing in February, 1974, Issue Of  
National States Rights Party (NSRP)  
Newspaper "The Thunderbolt"

SAC is a now defunct organization formed in San Diego, California, in 1971 as an anticommunist, paramilitary group. SAC intended to conduct intelligence-type investigations and to offer urban guerrilla training for use against "left-wing groups and suspected enemies of the U. S."

Godfrey was a San Diego Division extremist informant from 12/6/68 to 11/23/72. He was targeted to penetrate the SAC and subsequently became a SAC leader. We have no confirmed information in our files indicating his actual participation in "entrapment" activity or violent actions while with SAC. Numerous allegations were raised by the defense along this line during Hoover's trial and these allegations were refuted or explained in open court. Godfrey's testimony was instrumental in achieving successful prosecutions against several SAC members, and thereby producing the demise of the SAC.

Copies of the above three articles are attached.

ACTION:

None. For information. This newspaper has a small circulation aimed at its white hate membership. We are not refuting the allegations therein as to do so would serve no useful purpose and would merely prompt the NSRP to prolong these attacks.

J. EDGAR HOOVER  
WAS A MENTAL CASE  
AND A BLACKMAILER

For many years, William C. Sullivan was assistant director of J. Edgar Hoover at the FBI.

In fact, Sullivan was the main public spokesman for the FBI and Hoover, especially on those

occasions when Hoover personally spoke. Sullivan often spoke to conventions and important meetings in behalf of Hoover. If any man on the inside ever knew what Hoover really was, it was Assistant Director of the FBI William C. Sullivan.

William C. Sullivan gave a long written report to the White House in which he revealed that J. Edgar Hoover was not of sound mind in his last years. This was a long report which spelled out many of Hoover's illegal activities. He also told how Hoover kept files on congressmen and senators and blackmailed them during the forty eight years that he headed the FBI.

It is bad enough for a man to be a blackmailer and of unsound mind, but much worse when that man is the head of the nationwide secret police that has files on over half the American people.

Jew Daniel Ellsberg stole military secrets and has been accused of giving them to Russia. Yet, Hoover refused to investigate Ellsberg because of his friendship with Ellsberg's father-in-law, Jew Louis Marx. It is tragic when the chief of the secret police is surrounded with Jews.

William C. Sullivan gave his report to the White House. Then, the Senate Watergate Committee was given the report by John Dean, 3rd. The Watergate Committee has suppressed the Sullivan report ever since. They don't want the people to know the truth about how the FBI has been used to commit burglary, perjury, and break other laws in persecuting loyal White patriots throughout the country for many years. It would be well for every person to write to the senators on the Watergate Committee and demand that they release and publish the full text of the Sullivan Report which exposes the evils of the FBI.

A federal court recently ordered the FBI to turn over some of its documents on investigations to a reporter. The documents showed that the FBI had been illegally working for years and years not only spying upon rightwing patriotic organizations, but to also sabotage them. The only leftwing organizations sabotaged by the FBI were those that splintered and broke away from the discipline of the m.

157-3377-

facts that are now com-  
at about the FBI show  
the leftwing is so powerfu-  
e United States and the  
ts so weak. The FBI has  
doing a wrecking job on  
otic organizations over  
1924 while only giving lip  
ee to the fight against  
nism. While pretending  
against communism, the  
has been busy sabotaging  
organizations that are  
st communism.

Scummy FBI rats have just  
experienced a loss of reputation.  
According to the "National  
Observer," the public is no  
longer favorable to the FBI.  
One FBI agent, talking about  
then and now, was quoted as  
saying, "*When we'd show our  
credentials, we always got right  
in to get our information. Now  
we have to wait lots of times,  
and people don't seem so will-  
ing to help.*" The people are  
now learning that the FBI is  
the enemy of White Christian  
America. You are urged to  
write all of the senators on the  
Watergate Committee and all  
of the congressmen and  
senators from your state and  
urge that the Watergate Com-  
mittee publish William C.  
Sullivan's Report that exposes  
the criminal record of the FBI.

Secret police, like the FBI,  
are evil in every country.  
Aleksandr I. Solzhenitsyn, in  
his book "*the Gulag  
Archipelago*" exposing the  
evils of the secret police in  
Russia, said:

*"What would things have  
been like if every security  
operations man when he set out  
at night to make arrests was  
uncertain whether he would  
return alive and would have to  
say his goodbys to his own  
family?"*

*"Of if during mass arrests —  
as for example in Leningrad,  
when they arrested a quarter of  
the entire city — people had  
not just sat there growing pale  
at every banging of the  
downstairs door and at every*

We call upon every person to  
stand up for freedom and liber-  
ty in America and for taking  
power away from the mangey  
federal agents. Congress needs  
to repeal all of the anti-gun  
laws and all of the other evil  
laws that enable the  
Washington politicians to im-  
pose a police state on the peo-  
ple that is enforced with federal  
agents. Oppose federal tyran-  
ny. Oppose federal agents and  
do not answer their questions.  
Tell them to go to Hades!

# FBI's Hoover Called

## "Not Of Sound Mind"

By JACK NELSON  
WASHINGTON (LAT) — Wiretap files located by the FBI in a White House safe were kept from J. Edgar Hoover because he was "not of sound mind" in his last years, William C. Sullivan, former FBI assistant director told the Los Angeles Times Monday.

Sullivan said that because the late FBI director "could not be trusted" to keep the files confidential Sullivan turned them over to Assistant Atty. Gen. Robert Mardian before Hoover forced Sullivan to retire from the FBI on Oct. 6, 1971.

Sullivan, now director of the Justice Department's office of national narcotics intelligence, said John N. Mitchell, who was attorney general at the time, ordered that the files be given to Mardian.

Acting FBI Director William B. Ruckelshaus quoted Mardian as saying he transferred the files after Sullivan warned that Hoover "might use the records in some manner" against President Nixon and Mitchell.

RUCKELSHAUS said Sullivan did not "affirm" Mardian's claim in a statement to the FBI. But Sullivan told the Times he and Mardian did agree that Hoover might use the files for "some ill-conceived purpose" against government officials. "I don't specif-

ically remember mentioning the President," Sullivan said, "but we certainly had the President in mind."

Sullivan, who feuded with Hoover over FBI policy matters in the last few years before the director's death in May 1972, said that the wiretap records never were a part of the FBI's officially recorded files.

"Hoover didn't want the records in the official file," Sullivan said. "He told me to keep them myself and have them ready for him, available any time he wanted them. I had them in a file cabinet in my office, but they were never serialized or recorded in the FBI files."

Sullivan said that when Justice Department officials who knew of the wiretap records learned he was leaving "they were very upset and understandably because they could no longer depend on Hoover. He had been leaking stuff all over the place. He could no longer be trusted. So I was instructed to pass the records to Mardian."

HOOPER, who had been under considerable criticism for his administration of the FBI, was concerned about being fired as director and kept the records "to keep Mitchell and the others in line," Sullivan said.

That fellow was a master blackmailer and he did have considerable financial assets. The deterioration of his mind, Sullivan said.

"He always did that sort of thing. The moment he would get something on a senator he's send one of the boys boys up and advise the senator that we're in the course of an investigation and we by chance happened to come up with this data on your daughter. But we wanted you to know this — we realize you'd want to know it. But don't have any concern, no one will ever learn about it. Well, Jesus, what does that tell the senator? From that time on the senator's right in his place of."

Sullivan said that neither Mitchell nor Mardian ever specifically told him that they did not want Hoover to have the files because he could not be trusted. But Sullivan said he could "read this between the lines."

"NEITHER MARDIAN nor Mitchell trusted him but they didn't want to say that," Sullivan said. "Hoover wasn't of sound mind — as a matter of fact a high administration official once said Hoover had been of unsound mind for the past few years. Everybody who had anything to do with Hoover knew that he was no longer rational. He was doing the strangest things. Like going into a rage."

157-23577-

Enclosure

CALIFORNIA PATRIOT  
FREED IN FBI  
FRAMEUP CASE

Mr. George M. Hoover was a member of the now defunct right-wing "Secret Army Organization." Hoover, age 37 of Santee, California, was convicted last year of firing into the home of a Marxist radical named Peter Bohmer of San Diego.

It was later admitted by the federal prosecution that an FBI pimp named Howard Berry Godfrey had infiltrated the Secret Army. He had driven the car from which the shots were fired. Therefore the California Fourth District Court of Appeals ruled to overturn Hoover's conviction. Judge William T. Low said the jury should have been informed that the sole witness testifying against Hoover, and driver of

the car, was a paid FBI informer.

It was also charged that the pimp, Howard Godfrey, was the chief "firebrand" in the Secret Army and constantly encouraged violence. The FBI allowed Godfrey to participate in the shooting, several firebombings and burglaries before they arrested several others using Godfrey as their main witness against them.

Godfrey was so convincing that he rose to Assistant State Coordinator of The Secret Army. Through acts of violence he was able to prove his "loyalty" to the organization. The court deemed this an act of "entrapment." The FBI pimp was the provocateur of the acts of violence and his FBI superiors had the power to stop them before they occurred.

RIGHT-WING VICTORY

This important case represents an outstanding victory for Patriots everywhere. The victory of George M. Hoover over this FBI frameup helps to expose how far government agents will go to wreck patriotic groups. The disturbing part of this is that the FBI will itself break the law, with acts of violence, in order to maneuver innocent patriots into a trap, where they can then be framed by lying paid pimps testifying in court.

While this sort of skullduggery has been going on for some time, the true facts behind it all are just now coming to light. We have all read the chilling accounts of secret police terror in Russia and now we witness the very same thing taking place right here in this country.

Deleted Copy Sent

by Letter

Per FOIA Request

9/11/75 157-235-17-

Enclosure

FBI

Date: 10/31/73

Transmit the following in \_\_\_\_\_  
(Type in plaintext or code)

Via AIRTEL AIRMAIL-REGISTERED MAIL  
(Priority)

TO: DIRECTOR, FBI (157-23577)  
FROM: SAC, SAN DIEGO (157-2815) (RUC)

*80*  
*REC-30*

SECRET ARMY ORGANIZATION  
MILWAUKEE DIVISION  
EM; EXTORTION

Re Bureau airtel to Milwaukee and San Diego dated 10/16/73.

On 10/25/73 HOWARD BARRY GODFREY was contacted telephonically by SA ALFRED GARY GUNN. GODFREY, who is familiar with past activities of the Secret Army Organization (SAO) at San Diego, advised that he has no information regarding the SAO at Madison or any other city in Wisconsin. He is certain that there was no offshoot or related organization with connections at San Diego in the Madison, Wisconsin, area at the time the SAO was active in San Diego. He opined that the person sending threatening letters in Madison, Wisconsin, is not a San Diego resident, since he appears to have a knowledge of local political figures at Madison.

GODFREY mentioned one MIKE VELIVCEA who GODFREY recalled had reportedly been active in Minutemen-type activities at San Diego approximately four years ago. He

- ② - Bureau
- 2 - Milwaukee
- 1 - San Diego

*REC-30 157-23577-111*

21 NOV 2 1973

AGG:liw  
(5)

*37 NOV 14 1973*

*Handwritten signatures and initials*

Approved: \_\_\_\_\_  
Special Agent in Charge

Sent \_\_\_\_\_ M Per \_\_\_\_\_

U.S. Government Printing Office: 1972 - 455-574



California area involved themselves in a number of incidents of violence resulting in their arrest and incarceration on local charges, including attempted murder, illegal possession of explosives, and receiving stolen property. The SAO was reported deceased in October, 1972.

On 10/21/73 INFORMANT, who is familiar with current right wing extremist activities, advised that he has heard nothing about any FO type activities or connections at Madison, Wisconsin.

On 10/30/73 INFORMANT, who is familiar with some right wing extremist activities at San Diego at the present time, advised that he has no information about any connections or activities at Madison, Wisconsin.

On 10/31/73 CONFIDENTIAL source (protect as required) San Antonio, Texas, San Diego Police Department advised that his informant has no information indicating any connection at Wisconsin with any FO type activities at San Diego during 1971 and 1972.

In view of the fact that no positive information has been developed in this matter at San Diego, no FIM is being submitted.



10/18/73

To: SACs Milwaukee REC- 45  
San Diego

From: Director, FBI

157-23577-119

SECRET ARMY ORGANIZATION  
MEMBERSHIP DIVISION  
S.A. DIVISION

ST-103

Re: Airtel and LHM dated 9/23/73 captioned "Secret Army  
Organization - San Diego," no copies furnished San Diego.

For the information of Milwaukee, the Secret Army  
Organization (SAO) was an anticommunist, paramilitary organization  
formed in San Diego, California, in 1972. Its objectives were to  
conduct intelligence-type operations and to offer training in urban  
guerrilla warfare to be used against "left-wing groups and  
suspected enemies of the United States."

SAO members in the San Diego, California, area involved  
themselves in a number of incidents of violence resulting in their  
arrest and incarceration on local charges, including attempted  
murder, illegal possession of explosives, and receiving stolen  
property.

The SAO was reported defunct by the San Diego Division  
as of October, 1972.

From a review of information set forth in referenced LHM,  
it is not possible to determine whether the SAO referred to by  
your office has any connections with the SAO under investigation  
by San Diego.

PEN:rjn  
(7)

SEE NOTE PAGE THREE

OCT 15 3 36 PM '73

MAILED 22  
OCT 18 1973  
FBI

- Asst. Dir. \_\_\_\_\_
- Adm. Dir. \_\_\_\_\_
- Ident. \_\_\_\_\_
- Comp. Syst. \_\_\_\_\_
- Ext. Affairs \_\_\_\_\_
- Files & Com. \_\_\_\_\_
- Gen. Inv. \_\_\_\_\_
- Ident. \_\_\_\_\_
- Inspection \_\_\_\_\_
- Intell. \_\_\_\_\_
- Laboratory \_\_\_\_\_
- Plan. & Eval. \_\_\_\_\_
- Rec. Inv. \_\_\_\_\_
- Training \_\_\_\_\_
- Off. Coun. \_\_\_\_\_
- Telephone Rm. \_\_\_\_\_
- Director Sec'y \_\_\_\_\_

REG/K  
AG

FBI 1024033  
C. G. / E. P.

JOT PEN

MAIL ROOM  TELETYPE UNIT

Airtel to Milwaukee and San Diego  
Re: Secret Army Organization  
Milwaukee Division

If not already done, Milwaukee should promptly contact logical sources and informants for the purpose of determining complete information concerning the SAO's operations within the Milwaukee Division. You should also identify that group's leaders, approximate number of members, its organizational headquarters, source of funds, possession of weapons, the identity of any official publication, if any, and other pertinent operational data. You should also attempt to ascertain whether the SAO in Milwaukee may be an extension of the SAO in San Diego.

This matter should be afforded expeditious handling and results furnished in form suitable for dissemination at an early date. Where information developed by your office which is of pertinence to local authorities is promptly furnished to them.

For the information of San Diego, referenced LHM sets forth the contents of an anonymously typewritten letter received by the "Wisconsin State Journal," a Madison, Wisconsin, daily newspaper, during September, 1973. That letter, addressed to "To Whom It May Concern," indicated that "action" would be taken in the Madison, Wisconsin, area on 9/17/73 against "anti-American and anti-white organizations." The letter stated any and all offices of the "enemy" and "any enemy individual" would be destroyed. Specifically cited for such action were "various socialist groups and other left-wing organizations." The letter also threatened violent action against Paul Leglin, Mayor of Madison, Wisconsin, and Melvin D. Cohen, a local businessman. For your additional information, no acts of violence occurred against any organizations or the aforementioned individuals in the Madison area on 9/17/73.

San Diego Division immediately contact sources and informants familiar with the SAO in an attempt to make a determination as to whether the SAO currently reported active in the Milwaukee Division may be an off-shoot of, or have other connections with, the San Diego organization. Handle expeditiously and advise the Bureau and Milwaukee of positive information in form suitable for dissemination.

Airtel to Milwaukee and San Diego  
Re: Secret Army Organization  
Milwaukee Division

NOTE:

Instructions being set forth to Milwaukee and San Diego Divisions as result of information indicating the extremist Secret Army Organization may be active within the Milwaukee Division at this time. Information concerning letter received from the SAO in this instance was made available to the Milwaukee Office by the Criminal Intelligence Service of the Madison, Wisconsin, Police Department. Referenced airtel requested Bureau furnish Milwaukee with any background data concerning the SAO. That communication indicates that Milwaukee Division was not conducting investigation concerning the possible extortion aspects of this matter in view of investigation being conducted by the Madison, Wisconsin, Police Department, which was considering submission of the letter involved to the Laboratory for appropriate examinations. This has been coordinated with Supervisor W. J. Riley of the General Investigative Division.

FBI

Date: 9/28/73

Transmit the following in \_\_\_\_\_  
(Type in plaintext or code)

Via AIRTEL AIRMAIL - REGISTERED  
(Priority)

TO: DIRECTOR, FBI  
FROM: SAC, MILWAUKEE (157-NEW) (P)  
SUBJECT: SECRET ARMY ORGANIZATION  
EM; EXTORTION

*gl*

Enclosed for the Bureau are eight copies of an LHM dated and captioned as above which is self-explanatory.

Two copies of an FD 376 are stapled to the enclosed LHM.

In view of the position of PAUL SOGLIN, a copy of the enclosed LHM is being disseminated to Secret Service, Milwaukee.

For the information of the Bureau, Milwaukee indices are negative concerning HARLEY VON HADEN, STEVE ALDERMAN, and ALOISE E. MUELLER. There are numerous 100 references on PAUL R. SOGLIN with 100-11900. MEL CORN is referenced with Milwaukee's file on Vets for Peace in Vietnam. Milwaukee indices also has references on ALLEN C. DENNY and CLARENCE E. RASMUSSEN and his wife DOROTHY E.

ST-103 REC-45

157-2-17-1A-2

For the information of the Bureau, PAUL SOGLIN, who was elected to the position of Mayor, city of Madison, in March, 1973, has received in the past, national publicity thru "Look" magazine as "the boy alderman". While in this position, SOGLIN was a student at the University of Wisconsin - Madison and received local publicity in news media concerning his activities with student groups protesting the Vietnam war since 1968. Local news media is currently following the investigation of a petition signed by 103 police officers, Madison Police Department, concerning their dissatisfaction with the current Chief DAVID C. COUPER, who has received strong public backing from SOGLIN. This current situation has made

- 3 - Bureau (Enc. 8) (AM) (RM)
- 2 - Milwaukee

HMC/pss

(5)

9 OCT 1 1973

Approved: *[Signature]* Sent \_\_\_\_\_ M Per \_\_\_\_\_  
Special Agent in Charge

U.S. Government Printing Office: 1972 - 455-574

F B I

Date:

Transmit the following in \_\_\_\_\_  
(Type in plaintext or code)

Via \_\_\_\_\_  
(Priority)

MI 157-New

the current Madison Police Department investigation proceed cautiously. It is also believed that this matter was not brought to the attention of the FBI because of this situation.

Milwaukee is initiating investigation concerning the Secret Army Organization at Watertown, Wisconsin. Milwaukee indices are negative concerning this organization. The Bureau is requested to furnish Milwaukee with any background information on this group that may assist in its investigation. Milwaukee is not conducting any investigation concerning the extortion part of this matter in view of the investigative activity on the part of the Madison Police Department. The Madison Police Department is considering submitting the threatening letter to the FBI Laboratory and the Latent Fingerprint Section for appropriate examination.

2

Approved: \_\_\_\_\_ Sent \_\_\_\_\_ M Per \_\_\_\_\_  
Special Agent in Charge

U.S. Government Printing Office: 1972 - 455-574

DEPARTMENT OF JUSTICE  
FEDERAL BUREAU OF INVESTIGATION

WASHINGTON, D.C. 20535

In Reply, Please Refer to  
File No.

September 28, 1973

Director  
United States Secret Service  
Department of the Treasury  
Washington, D. C. 20220

RE: SECRET ARMY ORGANIZATION

Dear Sir:

The information furnished herewith concerns an individual or organization believed to be covered by the agreement between the FBI and Secret Service concerning protective responsibilities, and to fall within the category or categories checked.

1.  Threats or actions against persons protected by Secret Service.
2.  Attempts or threats to redress grievances.
3.  Threatening or abusive statement about U. S. or foreign official.
4.  Participation in civil disturbances, anti-U. S. demonstrations or hostile incidents against foreign diplomatic establishments.
5.  Illegal bombing, bomb-making or other terrorist activity.
6.  Defector from U. S. or indicates desire to defect.
7.  Potentially dangerous because of background, emotional instability or activity in groups engaged in activities inimical to U. S.

Photograph  has been furnished  enclosed  is not available.

Very truly yours,

  
Clarence M. Kelley  
Director

1 - Special Agent in Charge (Enclosure(s)) (1)  
U. S. Secret Service , Milwaukee (RM)

Enclosure(s)



UNITED STATES DEPARTMENT OF JUSTICE  
FEDERAL BUREAU OF INVESTIGATION

In Reply, Please Refer to  
File No.

Milwaukee, Wisconsin

September 28, 1973

SECRET ARMY ORGANIZATION  
EXTREMIST MATTER; EXTORTION

The following information was furnished by  
Detective John L. Heibel, Criminal Intelligence Service,  
Madison, Wisconsin, Police Department (MPD) on September  
25, 1973:

His department received a call from the Receptionist,  
"Wisconsin State Journal", a Madison daily newspaper,  
115 South Carroll Street, Madison, on September 18, 1973,  
advising the receipt of the following type-written  
anonymous letter:

"TO WHOM IT MAY CONCERN;

Be it known that on this day, September 17,  
1973, that action will begin in the Madison area against  
the anti-American and anti-white organizations.

Warning is hereby given that any and all  
offices of the enemy and any enemy individual is subject  
to destruction.

Individuals such as Paul Soglin and Mel Cohan  
will be eliminated. Organizations as the Wisconsin  
Alliance, the various socialist groups and other left  
wing organizations will be destroyed.

This document contains neither recommendations nor conclusions  
of the FBI. It is the property of the FBI and is loaned to  
your agency; it and its contents are not to be distributed  
outside your agency.

157-23577-100

ENCLOSURE

SECRET ARMY ORGANIZATION  
EXTREMIST MATTER: EXTORTION

Action will commence at 8 P.M. on September 19, 1973. Individuals enter enemy offices at their own risk.

Signed,

SECRET ARMY ORGANIZATION"

This letter was received through the United States mail. The envelope was addressed to the "Wisconsin State Journal, Madison, Wisconsin". It bore the postmark "US Postal Service, Watertown, WI. Sep. 17, PM - 1973".

Paul Soglin is identical to Paul R. Soglin, *WISC*  
current Mayor, city of Madison.

Mel Cohan is identical with Melvin D. Cohen, *WISC*  
owner and operator of the Fast Food Shop, Madison.

Soglin has not been interviewed by MPD, although the Mayor's Office was contacted. Cohen has not been interviewed. According to Heibel, it is believed that Cohen's name was included in the letter because he was active in the past years with the organization known as Vets for Peace in Vietnam.

VETERANS FOR PEACE IN VIETNAM  
MADISON, WISCONSIN

Remarks of the Honorable Olin E. Teague of Texas, made in the House of Representatives, March 13, 1968, as set forth in the Congressional Record of the 90th Congress concerned efforts by Communists to infiltrate and control Veteran organizations. Mr. Teague stated that at a meeting of the Committee to End the War in Vietnam at the University of Wisconsin campus in Madison on September 28, 1967, LeRoy Wolins made a statement that he wished to inform the Committee to End the War in Vietnam of the organization



of a Madison Branch of the Veterans for Peace in Vietnam. Wolins, according to Mr. Teague, made suggestions as to how the group should be organized, urging the use of symbols of the military "for the sake of image", including red, white and blue colors. Wolins also wanted the group to distribute literature against the war in Vietnam at induction centers and Legion halls and asked the group to write to men in service, hoping to get letters from which excerpts can be made to use for propaganda purposes. Mr. Teague further identified Wolins as a card-carrying professed member of the Communist Party of Illinois until 1946, and after that, until 1966, active in Communist Party circles.

Mr. Teague further stated that Robert Wilkinson had been the man selected to be acting chairman of the Madison area Veterans for Peace in Vietnam.

A characterization of the Committee to End the War in Vietnam is attached.

STUDENT MOBILIZATION COMMITTEE TO  
END THE WAR IN VIETNAM

The Student Mobilization Committee to End the War in Vietnam (SMC) is controlled by the Socialist Workers Party (SWP) and its youth affiliate, Young Socialist Alliance. SMC

initiates and supports public demonstrations against war in Southeast Asia.

SOCIALIST WORKERS PARTY

The Socialist Workers Party has been designated pursuant to Executive Order 10450.

YOUNG SOCIALIST ALLIANCE

As the youth organization of the Socialist Workers Party (SWP), the Young Socialist Alliance serves as the main source of recruitment into that organization. The YSA is described in the masthead of its official publication, "The Young Socialist Organizer", as "a multi-national revolutionary socialist youth organization".

"THE YOUNG SOCIALIST ORGANIZER"

"The Young Socialist Organizer" is self-described as a biweekly action publication of the Young Socialist Alliance (YSA).

No instances have occurred at any of the named places in the above letter.

MPD has conducted an inquiry in an effort to identify the sender of the letter.

Harry Buerger, Chief Deputy, Jefferson County Sheriff's Department, Jefferson, Wisconsin, advised Heibel that a possible suspect could be a Rick Mandell, a former serviceman who, sometime in 1973, talked about organizing a guerilla group with the purpose of fighting

"left wing organizations". Mandell's present whereabouts are unknown.

Inspector Richard L. Reynolds, Watertown, Wisconsin, Police Department, advised Heibel that there have been individuals in Watertown in the past who have attempted to organize the John Birch Society chapter. Al Denny and (first name unknown) Paulson are involved in a Birch-like organization known as Sentinel Corporation of Wisconsin. Reynolds knows of no current activity on the part of Denny, Paulson or any other extremist organization in Watertown.

Heibel stated that the corporation records of the Secretary of State, Capitol Building, Madison, Wisconsin, show that the Sentinel Corporation of Wisconsin was organized in 1964 at Fort Atkinson, Wisconsin. The initial officers listed were:

Allen C. Denny - President  
Charlotte E. Denny - Secretary - Treasurer,  
address 521 East Street, Fort Atkinson, WIS

Clarence E. Rasmussen - Vice-President  
Dorothy E. Rasmussen - Second Vice-President,  
address Route 2, Whitewater, Wisconsin

The corporation was organized to conduct business under the general statute of Wisconsin with no specific purpose stated in the articles of the corporation. Authorized shares were 4,250 shares of common stock, no-par value. There are listed on early reports that 220 shares are issued and outstanding; no holder is identified. The 1966 Annual Report deleted both the Rasmussens as officers of the corporation and added Harley Von Haden, 217 Merchants Street, Fort Atkinson, Wisconsin, as Director. In 1968, Von Haden's address was shown as 105 South Third Street, Fort Atkinson. In 1969 the Dennys and corporate address were listed as 911 Harvey Avenue, Watertown.

SECRET ARMY ORGANIZATION  
EXTREMIST MATTER; EXTORTION

Inspector Reynolds also mentioned that his department currently has under consideration an application for the position of police officer from a Steve Alderman, a former Marine trained in demolitions. This application is still in the process of being considered but Reynolds is possibly going to recommend non-acceptance due to the juvenile record on file with the department for Alderman. This record concerns many complaints of Alderman making pipe bombs.

Heibel has also developed information that an Aloise E. Mueller, Watertown, Wisconsin, could also be considered as a suspect. Mueller is the former Executive Secretary of Local 695, Teamsters, Madison. Mueller has a reputation of being very anti-liberal and is very upset with the current political leans of the officers of Local 695. It is reported that Mueller is currently carrying a firearm.

MPD is continuing their investigation at the Madison level.

A source, on February 11, 1965, advised that a group informally known as the Ad Hoc Committee for Peace in Vietnam, was registered as a student organization at the University of Wisconsin (UW), Madison, Wisconsin, on or about February 12, 1965, under the name of "Committee to End the War in Vietnam" (CEWV). Its purposes were state generally as campaigning to bring an end to the war in Vietnam, and it claimed to be a non-affiliated, independent local organization.

On November 29, 1966, a second source advised that the CEWV sponsored frequent protests directed against U.S. policy in Vietnam during the years 1965-66. Robin David became chairman at the beginning of the 1966-67 academic school year and received some notoriety when he led the CEWV in disruptive tactics during a speech by Senator Edward Kennedy at the UW, Madison, on October 27, 1966.

The February 17, 1967, issue of "The Daily Cardinal," UW campus newspaper, quoted Robin David as saying he was a member of the Young Socialist Alliance (YSA) in Madison, Wisc.

A characterization of the YSA is attached.

A third source advised on January 25, 1969, that leaders of the YSA in Madison continued to control and dominate the CEWV. Headquarters of both the CEWV and the YSA are at 202 West Gilman Street, Madison.

A fourth source advised on December 5, 1969, that the CEWV had voted to change its name to the Student Mobilization Committee to End the War in Vietnam (SMCEWV) in order to emphasize its link to the mass organization of anti-war youth.

A characterization of the SMCEWV is attached.

#### APPENDIX

# Memorandum

TO : DIRECTOR, FBI (157-23577)

DATE: 10/4/73

FROM : SAC, SAN DIEGO (157-2315) (C)

SUBJECT: SECRET ARMY ORGANIZATION (SAO)  
EXTREMIST MATTERS - WHITE HATE

*J.R.*

*6/10/73*

Re San Diego report of SA EARL M. PETERSEN, 2/21/73; Las Vegas letter to San Diego, 3/27/73; Seattle letter to San Diego, 4/30/73; Los Angeles airtel to San Diego, 3/6/73; Baltimore letters to San Diego, 3/30/73 and 3/29/73; San Diego airtel to Bureau, 6/30/73; San Diego teletype to Bureau, 6/21/73.

Enclosed for the Bureau are eight copies of an LHM.

One copy of the enclosed LHM is being furnished to the United States Secret Service, San Diego, in view of their interest in the activities of the Secret Army Organization.

Two copies of an FD-376 are stapled to copies of the enclosed LHM.

The following sources were contacted to determine whether the SAO is presently active:

## INFORMANTS

, and HOWARD BARRY GODFREY formerly a source within the SAO.

*W*  
ENCLOSURE

REC-11

*157-2315-11-99*

- ② - Bureau (Enc. 3) (RM)
- 1 - San Diego

EX-112

EMP:blb  
(3) ICC/SS/ISS/SCU  
R/S 10/19/73

OCT 9 1973

54 OCT 30 1973  
100-6220  
3cc destroyed

*W*  
REC-11

Buy U.S. Savings Bonds Regularly on the Payroll Savings Plan



PREDICATION FOR INVESTIGATION OF THE ORGANIZATION

This investigation was based on information which indicated that the Secret Army Organization (SAO) was engaged in activities which could have involved a violation of Title 18, United States Code, Sections 245(b)(3), Chapter 102, 2101-2102, and Chapter 12, 231-233 (Antiriot Laws) or 241 (Civil Rights Act of 1968). The SAO was an anticommunist, paramilitary organization formed in 1971 in San Diego, California. It intended to conduct intelligence-type operations and to offer training in urban guerrilla warfare to be used against "left-wing groups" and suspected enemies of the United States.

FORMER MEMBERS AND ASSOCIATES OF MEMBERS OF THE SAO SHOULD BE CONSIDERED ARMED AND DANGEROUS IN VIEW OF THE NUMEROUS WEAPONS AND EXPLOSIVES FOUND IN THEIR POSSESSION AND BECAUSE THEY HAVE USED BOMBS AND HAVE BEEN INVOLVED IN SHOOTINGS IN THE PAST.



UNITED STATES DEPARTMENT OF JUSTICE

FEDERAL BUREAU OF INVESTIGATION

October 4, 1973

WASHINGTON, D.C. 20535

In Reply, Please Refer to  
File No. 157-23577

Director  
United States Secret Service  
Department of the Treasury  
Washington, D. C. 20220

RE: SECRET ARMY ORGANIZATION

Dear Sir:

The information furnished herewith concerns an individual or organization believed to be covered by the agreement between the FBI and Secret Service concerning protective responsibilities, and to fall within the category or categories checked.

- 1.  Threats or actions against persons protected by Secret Service.
- 2.  Attempts or threats to redress grievances.
- 3.  Threatening or abusive statement about U. S. or foreign official.
- 4.  Participation in civil disturbances, anti-U. S. demonstrations or hostile incidents against foreign diplomatic establishments.
- 5.  Illegal bombing, bomb-making or other terrorist activity.
- 6.  Defector from U. S. or indicates desire to defect.
- 7.  Potentially dangerous because of background, emotional instability or activity in groups engaged in activities inimical to U. S.

Photograph  has been furnished  enclosed  is not available.

Very truly yours,

*Clarence M. Kelley*  
Clarence M. Kelley  
Director

1 - Special Agent in Charge (Enclosure(s))  
U. S. Secret Service, San Diego

Enclosure(s)





UNITED STATES DEPARTMENT OF JUSTICE  
FEDERAL BUREAU OF INVESTIGATION

In Reply, Please Refer to  
File No.

San Diego, California  
October 4, 1973

SECRET ARMY ORGANIZATION

The Secret Army Organization (SAO) was an anticommunist, paramilitary organization formed in 1971 in San Diego, California. It intended to conduct intelligence-type operations and to offer training in urban guerrilla warfare to be used against "left-wing groups" and suspected enemies of the United States.

On June 21, 1973, Deputy District Attorney Frank Sexton, Office of the San Diego County District Attorney, San Diego, California, advised that as a result of his entering a plea of guilty to a charge of possession of explosive materials on January 15, 1973, Jerry Lynn Davis, San Diego leader of the SAO, was sentenced on June 21, 1973, to three years probation. This sentence provided that he serve 134 days in the custody of the San Diego County Sheriff's Office. The 134 days had been served previous to the time Davis was sentenced. A condition of his probation was a waiver of search and seizure rights.

Sources in Baltimore, Las Vegas, Los Angeles, Phoenix, San Diego, and Seattle who are in a position to furnish information regarding SAO activity and who have furnished reliable information in the past, advise that the SAO no longer exists as an organization.

This document contains neither recommendations nor conclusions of the FBI. It is the property of the FBI and is loaned to your agency; it and its contents are not to be distributed outside your agency.

157-32277-99

ENCLOSURE

SECRET ARMY ORGANIZATION

FORMER MEMBERS AND ASSOCIATES OF MEMBERS OF THE  
SAO SHOULD BE CONSIDERED ARMED AND DANGEROUS IN VIEW OF  
THE NUMEROUS WEAPONS AND EXPLOSIVES FOUND IN THEIR POSSESSION  
AND BECAUSE THEY HAVE USED BOMBS AND HAVE BEEN INVOLVED IN  
SHOOTINGS IN THE PAST.

- 2\* -

*law offices of*  
Frederick  
Hetter  
*attorney at law*

fifth and olive bldg.  
440 olive street  
san diego, CA 92103  
(714) 291-6970

ENCLOSURE

159 - 23577 - 98

FREDERICK HETTER  
440 OLIVE STREET  
SAN DIEGO, CALIFORNIA 92103



NOV 12 1973  
DEPT OF JUSTICE  
MAIL ROOM  
DISH

Eliot Richardson, Attorney General  
Department of Justice  
Constitution Avenue  
Between 9th & 10th Avenues  
Washington, D.C. 20530

RECEIVED FREDERICK

Hetter

attorney at law

JUN 24 4 40 PM

June 22, 1973

100-1001  
GROW

COPIES

MEMORANDUM RE JERRY LYNN DAVIS SENTENCING

Re: People v. Jerry Lynn Davis;  
People v. William Francis Yakopec;  
Watergate Conspiracy.

On June 21, 1973, Jerry Lynn Davis, former Southern California Coordinator of the Secret Army Organization was granted probation as a result of a psychiatric and social study conducted by the California Department of Corrections. Thus ends the last of the now famous "Secret Army" cases, but the inferences of wrongdoing and the patent injustice of the entire persecution remain obvious to everyone. Various organizations are still looking into Watergate implications of Secret Army cases. Others are seriously concerned with the wrongdoings of those who acted with implied or explicit authority of the United States Government. These men remain free.

The Federal Bureau of Investigation informant, Howard Berry Godfrey, remains free. At various times and places he admitted to a number of major felonies. These include the following: possession of illegal explosives -- these are the explosives which Yakopec allegedly used to blow up the Guild Theater and they are the same explosives which are the basis for Davis' conviction; detonating incendiary device (admitted at the Yakopec trial); burglary (admitted at the Hoover hearings); sale of explosives (admitted at the Yakopec trial); concealing evidence of a felony (admitted at the Hoover trial).

Mr. Godfrey has admitted these felonies yet he is free. How can the District Attorney of San Diego County sleep with his conscience when this man remains free? Or, is Mr. Edwin Miller governed by the Watergate standard of ethics and morality? Mr. Godfrey acted for the best of all possible motives. He did commit some crimes. But "his aims and ideas were good." Therefore, he should not be punished for his crimes but should, like Mr. Barker and Mr. Hunt, be praised for violating the law of California. Is this the District Attorney's idea of enforcing the law and protecting the citizens of this County? Howard Berry Godfrey must be brought to justice.

157-23577- 10 JUL 3 1973

Steve Christiansen, agent of the Federal Bureau of Investigation, professional police officer and employee of the United States, has been directly implicated in the following crimes: concealing evidence of a felony (in the Hoover trial); aiding and abetting (Godfrey) a person to commit a felony, i.e., possession of illegal explosives (see Yakopec trial); concealing evidence of a felony, i.e., hiding the pistol used in the Tharpe shooting for over six months (Hoover trial).

XEROX  
16 1973

ENCLOSURE

This Federal employee willingly and wantonly violated the laws of this State. He knew what he was doing. Had he advised the local police of the Tharp shooting, the Guild Theater would never have been bombed. Had he not permitted Godfrey to possess illegal explosives in his home, the Guild Theater would never have been bombed. Without Mr. Christiansen there would never have been any number of crimes committed in this community. For the best of all possible motives, he too possessed a Watergate mentality and justified everything on the basis of the results. To him, apparently, the "result justifies the means." Regardless of how much lawbreaking there was. Why is not the District Attorney of this County seeking an indictment against Mr. Christiansen? Does Mr. Christiansen claim "exutive immunity" as did the Watergate conspirators? Was the Federal government justified in this sort of illegality and immorality, how? The only possibility is that we citizens of this County and of this National must accept immoral and illegal acts on the part of our civil servants, justified because they act on a higher morality than we near mortals. Or, alternatively, we may pose the question: How deeply was the United States involved in the Godfrey-Christiansen conspiracy? Did Godfrey have permission from the Federal Bureau of Investigation to violate the law? Was the Secret Army Organization really an arm of the F.B.I? Was it used by the F.B.I to do acts the FB.I. itself could not do? Please -- Mr. Richardson -- answer the question.

FREDERICK HETTER  
FH:h

*By airtel 6/21/73, captioned "Donald Henry Segretti; Election Pans", the San Diego Office was instructed to contact Hetter and request he furnish any information of possible violations of Federal Law if he has any information of possible violation of local or State Law. It should be suggested he furnish this data to appropriate local or state authorities. SA [Name] was instructed not to engage in any discussions relating to handling information on this aspect of Bureau's jurisdiction in work.*

*Handwritten notes and signatures on the left side of the page, including "W. H. Hetter" and "J. P. [Name]".*

*CCM/SCD*

*NRW/RCS*

F B I

Date: 6/30/73

Transmit the following in \_\_\_\_\_  
(Type in plaintext or code)

Via A I R T E L \_\_\_\_\_  
(Priority)

TO : ACTING DIRECTOR, FBI (157-23577)

FROM: SAC, SAN DIEGO (157-2315) (P)

SECRET ARMY ORGANIZATION (SAO)  
EXTREMIST MATTERS

Re Bureau airtel to San Diego 6/28/73; San Diego facsimile 1/27/73; San Diego airtel and letterhead memorandum 3/13/72; San Diego teletype 6/4/73, entitled "JAMES WALTER MC CORD, JR., AKA; ET AL. BURGLARY OF DEMOCRATIC NATIONAL COMMITTEE HEADQUARTERS, WASHINGTON, D. C., JUNE 17, 1972, IOC. (BUFILE: 139-4039). OO: WFO, AND SAO."

HOWARD BARRY GODFREY, for a number of years, voluntarily furnished the FBI information regarding the identities and activities of extremist groups in the San Diego area. His information has been reliable and as an interested citizen, he volunteered his knowledge and services to local law enforcement agencies which culminated in his appearance and testimony before the San Diego County Grand Jury in June and July, 1972.

As an informant for the FBI, GODFREY became a leader in the SAO. As such he contributed his dues and occasionally furnished small amounts of money for stationary and other supplies.

GODFREY testified extensively before San Diego County Grand Juries and in the San Diego County Superior Court in a number of trials in 1972 and 1973, resulting in the conviction of members of the SAO for offenses including assault on a police officer, bombing, attempted murder, shooting into an occupied

2 - Bureau  
2 - San Diego

EMP:blb  
(4)

12 JUL 3 1973

Approved: \_\_\_\_\_ Sent \_\_\_\_\_ M Per \_\_\_\_\_  
Special Agent in Charge

U.S. Government Printing Office: 1972 - 495-574

dwelling and perjury. This resulted in several convictions and sentences ranging up to five years to life in prison. While testifying in open court, numerous allegations such as his involvement in shooting, fire-bombings, and burglaries were brought up by the defense and all such charges were refuted or explained in open court. As a member of a group becoming increasingly involved in violent activities, GODFREY was hard pressed not to become involved in some of these activities and still continue his effectiveness as an informant for the FBI.

A reporter for the "Door", a San Diego Underground-type newspaper, contacted former SA JAMES B. CHRISTENSEN on 6/4/73, asking when CHRISTENSEN was to testify before the Watergate Federal Grand Jury or the Senate Investigating Committee because in 1972, one DONALD SEGRETTI, using the alias DONALD SIMPSON, had allegedly contacted SAO members in San Diego to enlist volunteers from the SAO to assist SEGRETTI in connection with a group believed to have been The Committee to Re-Elect the President. When interviewed by Agents of the FBI, this reporter said he had no information concerning any contact of SAO members by SEGRETTI. This same reporter was one of the authors of an article in the 6/14-29/73 issue of the "Door" alleging that DONALD SEGRETTI and another person visited the "Gunsmoke Ranch" during the summer of 1971, and that the Gunsmoke Ranch was frequented by members of the SAO. The SAO was formed during October and November, 1971.

GEORGE MITCHELL HOOVER, SAO member convicted of shooting into the home of radical professor, PETER BOHMER, and sentenced to five years to life in prison, lived at the Gunsmoke Ranch. A number of individuals interested in practicing with personally owned firearms frequented the Gunsmoke Ranch. Some of these individuals were then members of the National Socialist White Peoples Party (NSWPP), and some later became members of the SAO. Neither the SAO or the NSWPP are known to have participated in organized firearms practice sessions at the Gunsmoke Ranch.

The Bureau has been kept fully informed concerning the above in Bureau file 157-23577.



airtel

To: SAC, San Diego

- 1 - R. E. Gebhardt
- 1 - G. H. Menzel
- 1 - C. A. Mosher

6/28/73

From: Acting Director, FBI

SECRET ARMY ORGANIZATION (SAO)  
EXTREMIST MATTERS

*Q*  
*9*

Attached is an article entitled "FBI Informer Is Linked to Right-Wing Violence," which appeared on Page 30 of the 6/24/73 edition of the Sunday "The New York Times"

The article alleges the SAO was partly organized and financed by an FBI informer (Howard Barry Godfrey) and that Godfrey participated in a shooting as well as several fire bombings and burglaries.

Godfrey is alleged to have told friends and testified in court that he participated in a "series of violent actions" against the community of "left-wing radicals" in San Diego.

San Diego review attached article. Contact appropriate law enforcement agencies for full details relative to Godfrey's alleged participation in burglaries and fire bombings and other violent activities mentioned in attached article.

REC-15 107-2577-9

Promptly furnish FBIHQ all information developed relative to allegations contained in attached article.

Enclosure

EX-104

16 JUN 27 1973

CAM:aso (6)

MAILED 6  
JUN 27 1973  
FBI

NOTE:

San Diego is being instructed to review attached "The New York Times" article and to furnish FBIHQ with all information available confirming or disproving allegations contained therein. Godfrey was an extremist informant of the San Diego Office from 12/6/68 through 11/20/72.

- Mr. Felt \_\_\_\_\_
- Mr. Baker \_\_\_\_\_
- Mr. Callahan \_\_\_\_\_
- Mr. Cleveland \_\_\_\_\_
- Mr. Conrad \_\_\_\_\_
- Mr. Gebhardt \_\_\_\_\_
- Mr. Jenkins \_\_\_\_\_
- Mr. Marshall \_\_\_\_\_
- Mr. Miller, E.S. \_\_\_\_\_
- Mr. Soyars \_\_\_\_\_
- Mr. Thompson \_\_\_\_\_
- Mr. Walters \_\_\_\_\_
- Tele. Room \_\_\_\_\_
- Mr. Baise \_\_\_\_\_
- Mr. Barnes \_\_\_\_\_
- Mr. Bowers \_\_\_\_\_
- Mr. Herington \_\_\_\_\_
- Mr. Conroy \_\_\_\_\_
- Mr. Hunt \_\_\_\_\_
- Mr. Earles \_\_\_\_\_
- Mrs. Hogan \_\_\_\_\_

JUL 5 1973

*GCM*

MAIL ROOM  TELETYPE UNIT

*JOI CAM*

# Memorandum

TO : Mr. E. S. Miller *EM/aso*

FROM : G. C. Moore *CCM/aso*

SUBJECT: SECRET ARMY ORGANIZATION (SAO)  
EXTREMIST MATTERS

1 - Mr. C. Eardley  
1 - Mr. R. Gebhardt

DATE: 6/25/73

1 - Mr. E. S. Miller  
1 - Mr. G. C. Moore  
1 - Mr. C. A. Mosher

Mr. Callahan \_\_\_\_\_  
Mr. Cleveland \_\_\_\_\_  
Mr. Conrad \_\_\_\_\_  
Mr. Gebhardt \_\_\_\_\_  
Mr. Jenkins \_\_\_\_\_  
Mr. Marshall \_\_\_\_\_  
Mr. Miller, E.S. \_\_\_\_\_  
Mr. Soyars \_\_\_\_\_  
Mr. Thompson \_\_\_\_\_  
Mr. Walters \_\_\_\_\_  
Tele. Room \_\_\_\_\_  
Mr. Baise \_\_\_\_\_  
Mr. Barnes \_\_\_\_\_  
Mr. Bowers \_\_\_\_\_  
Mr. Herington \_\_\_\_\_  
Mr. Conmy \_\_\_\_\_  
Mr. Mintz \_\_\_\_\_  
Mr. Eardley \_\_\_\_\_  
Mrs. Hogan \_\_\_\_\_

*gcb*

The purpose of this memorandum is to set forth information relating to the attached article concerning the SAO and Howard Barry Godfrey, former FBI informant, which appeared in the 6/24/73 edition of "The New York Times." The article alleges the SAO was partly organized and financed by Godfrey and that while being paid by the FBI he participated in a shooting, several fire bombings and burglaries. It sets forth information indicating Donald H. Segretti had been in the company of SAO members during the Summer of 1971 and discussed kidnaping "radicals" who might disrupt the Republican National Convention.

The SAO was formed in San Diego, California, in 1971 by Jerry Lynn Davis as an anticommunist, paramilitary group to replace the white extremist Minutemen. Godfrey, an FBI informant since 1967 was targeted to penetrate the SAO and subsequently became a leader of this group. He was cautioned, as are all extremist informants, not to become directly involved in violent confrontations or activities. We have no information in our files indicating his active participation in fire bombings, burglaries, or violent actions by SAO. Specifically, we have no information relative to burglaries at "The Street Journal," described as a left-wing newspaper, or the "Message Information Center," described as a "counter-culture outpost," or the fire bombing of any automobiles, as reported in "The New York Times" article. We have no information indicating payments to Godfrey were used to fund the SAO.

*REC-15 1-7-73 95*

Information relative to the shooting of Paula Tharp on 1/6/72 was previously set forth in memoranda from G. C. Moore to Mr. E. S. Miller, dated 1/14/72 captioned "INFORMANT Extremist Informant," and 8/31/72 captioned "Secret Army Organization, Extremist Matters." These memoranda indicate Godfrey was with an

Enclosure  
157-23577  
CAM:aso (6)

16 JUN 27 1973  
CONTINUED - OVER

*5-7-73*

Memorandum to Mr. E. S. Miller  
Re: Secret Army Organization (SAO)  
157-23577

SAO member who fired shots into the home of a local college professor active in planning demonstrations at the Republican National Convention. The shots resulted in the wounding of Tharp. Godfrey, in January, 1972 advised SA Steven L. Christensen of the shooting and gave him the gun used. Christensen retained this weapon without advising the Bureau of its existence. On 7/5/72, after Godfrey was turned over to the San Diego Police Department in order to obtain prosecution of several SAO members, the existence of the gun was learned and it was recovered. SA Christensen, on 7/6/72, after acknowledging receipt of the gun, submitted his resignation.

Investigation of the SAO and testimony by former informant Godfrey, Christensen and Special Agents of our San Diego Office during local prosecution of SAO members, were coordinated with the Office of Legal Counsel and Kevin T. Maroney, Deputy Assistant Attorney General, Internal Security Division.

By memorandum from C. L. Mc Gowan to Mr. R. E. Gebhardt, date 6/15/73, captioned "Donald Henry Segretti," you were furnished information indicating the "San Diego Door," an underground publication, made inquiry of former SA Christensen regarding attempts by Segretti to recruit the SAO to work for reelection of the President and that Davis former SAO leader, stated he had no information regarding alleged recruitment.

San Diego is being instructed to promptly furnish any information indicating statements in the article regarding Godfrey's actual involvement in illegal activities may be true.

ACTION: For information.

*WR*

*EM*

*JOI*

*CAM*

*WEL*

By **VEN V. ROBERTS**

Special to The New York Times

**SAN DIEGO, June 23**—A lead ordinator had pleaded guilty, er of a right-wing, paramilitary and was granted probation.

organization that harassed According to Davis's account, young leftists here for more the Secret Army Organization, than a year says that the group was formed in 1971 to train, was partly organized and financed by an informer for the guerrillas who could organize a resistance movement should the United States be conquered by a foreign power. Howard Godfrey, the F.B.I. informer, The informer, Howard Berry was one of the six founding members and contributed money used to print the group's recruiting literature, Davis said. Godfrey participated in a shooting, as well as several fire-bombings and burglaries, while receiving regular payments from the F.B.I. for his services, it was said. In addition, Godfrey was considered a "firebrand" within the organization and took a "more militant line" than most members, Davis said.

This account was provided this week by Jerry Lynn Davis, the former Southern California coordinator for the Secret Army Organization, a well-armed outgrowth of another right-wing group, the Minutemen.

Godfrey told friends, and in some cases later testified in court, that he had participated in a series of violent actions against the rather small but vocal community of left-wing radicals in San Diego.

**Segretti Recognized**

In another development this week, two members of the Secret Army Organization reportedly recognized a photograph of Donald H. Segretti, the young lawyer accused of organizing a Republican espionage campaign last year. According to The Door, a local radical newspaper, the two rightists identified the man in the photograph as "Donald Simms," whom they said they met in the summer of 1971 at a shooting range frequented by members of the Secret Army Organization.

Law enforcement agents say that Godfrey also performed several other burglaries and fire-bombed at least two cars belonging to radical sympathizers.

The two men reportedly said that "Simms" was present at a discussion among the right-wingers about the Republican National Convention, originally scheduled to be held in San Diego last August before it was moved to Miami Beach. "Simms" did not participate in the discussion but an unidentified companion did, according to The Door's sources.

**Agent Hid Gun**

Mr. Segretti, who has been indicted for distributing false campaign literature in Florida, often used the name "Donald Simmons" in recruiting espionage agents.

Godfrey took the gun used in the shooting and gave it to his F.B.I. contact. The agent hid it under his couch for six months until the Secret Army Organization member who shot Miss Tharp was finally apprehended by the police. The incident cost the agent his job. Given Godfrey's contributions to the Secret Army Organization in time and money, Davis said, "you might say that the S.A.O. was a federally funded anti-poverty program for the right wing."

Davis, a 31-year-old construction worker, spoke to a reporter after being released last Thursday from jail, where he had been held pending his sentencing on a charge of possession of explosives. The Secret Army Organization co-ordinator.

- Mr. Conroy \_\_\_\_\_
- Mr. Gebhardt \_\_\_\_\_
- Mr. Jenkins \_\_\_\_\_
- Mr. Marshall \_\_\_\_\_
- Mr. Miller, E.S. \_\_\_\_\_
- Mr. Soyars \_\_\_\_\_
- Mr. Thompson \_\_\_\_\_
- Mr. Walters \_\_\_\_\_
- Tele. Room \_\_\_\_\_
- Mr. Baise \_\_\_\_\_
- Mr. Barnes \_\_\_\_\_
- Mr. Bowers \_\_\_\_\_
- Mr. Herington \_\_\_\_\_
- Mr. Conmy \_\_\_\_\_
- Mr. Mintz \_\_\_\_\_
- Mr. Eardley \_\_\_\_\_
- Mrs. Hogan \_\_\_\_\_

- The Washington Post \_\_\_\_\_
- Times Herald \_\_\_\_\_
- The Evening Star (Washington) \_\_\_\_\_
- The Sunday Star (Washington) \_\_\_\_\_
- Daily News (New York) \_\_\_\_\_
- Sunday News (New York) \_\_\_\_\_
- New York Post \_\_\_\_\_
- The New York Times P. 32
- The Daily World \_\_\_\_\_
- The New Leader \_\_\_\_\_
- The Wall Street Journal \_\_\_\_\_
- The National Observer \_\_\_\_\_
- People's World \_\_\_\_\_

Date 6/24/73

Placed Copy Sent Douglas Parker  
by letter 9/14/75  
Per FOIA request of \_\_\_\_\_

ENCLOSURE

157-23577-95

CODE

TELETYPE

URGENT

TO: SAC, SAN DIEGO (157-2815)

1 - C. A. Mosher

6/22/73

FROM: ACTING DIRECTOR, FBI (157-23577) *94*

*REC-31*  
*EX-103*

SECRET ARMY ORGANIZATION (SAO), EXTREMIST MATTERS.

RESDTL 6/21/73.

REVIEW OF BUREAU FILE INDICATES NO REASON WHY JERRY LYNN DAVIS SHOULD BE REINTERVIEWED AT THIS TIME. IT IS NOTED DAVIS REFUSED TO BE INTERVIEWED IN JANUARY, 1973. IF COMPELLING REASONS FOR INTERVIEW EXIST SUBMIT FULL JUSTIFICATION TO FBIHQ AND AWAIT BUREAU APPROVAL. UNDER NO CIRCUMSTANCES IS DAVIS TO BE INTERVIEWED WITHOUT PRIOR BUREAU APPROVAL.

CAM:aso (3)

NOTE:

Referenced San Diego teletype advises Jerry Lynn Davis to be interviewed by San Diego Agents. Davis was formerly active in Minutemen, and is former leader of SAO, San Diego, California. He was recently sentenced by San Diego County Superior Court to three years probation and 134 days in custody San Diego County Sheriff after guilty plea on charge of possession of explosive materials. Davis' attorney, Frederick Hetter, has written letters to Department and FBI complaining of previous interviews of his client by Special Agents without his approval. San Diego being instructed not to interview Davis and to furnish FBIHQ with full justification for interview if compelling reasons exist for such interview.

- Mr. Felt \_\_\_\_\_
- Mr. Baker \_\_\_\_\_
- Mr. Callahan \_\_\_\_\_
- Mr. Cleveland \_\_\_\_\_
- Mr. Conrad \_\_\_\_\_
- Mr. Gebhardt \_\_\_\_\_
- Mr. Jenkins \_\_\_\_\_
- Mr. Marshall \_\_\_\_\_
- Mr. Miller, E.S. \_\_\_\_\_
- Mr. Soyars \_\_\_\_\_
- Mr. Thompson \_\_\_\_\_
- Mr. Walters \_\_\_\_\_
- Tele. Room \_\_\_\_\_
- Miss Gandy \_\_\_\_\_

FEDERAL BUREAU OF INVESTIGATION  
COMMUNICATIONS SECTION

1:58 PM KXH

TELETYPE

*CAM*

*GCM JOI*

MAIL ROOM

TELETYPE UNIT

JUN 21 1973

Mr. Cleveland	_____
Mr. Conrad	_____
Mr. Gurnea	_____
Mr. Jenkins	_____
Mr. Marshall	_____
Mr. Miller	_____
Mr. Rogers	_____
Mr. Thompson	_____
Mr. Walters	_____
Tele. Room	_____
Mr. Soles	_____
Mr. Barnes	_____
Mr. Bowers	_____
Mr. Hadrington	_____
Mr. Conroy	_____
Mr. Minz	_____
Mr. Hardley	_____
Mrs. Hogan	_____

NR09 SD PLAIN

740PM 6-21-73 NITEL EJT

TO: ACTING DIRECTOR, FBI (157-23577)

FROM: SAN DIEGO (157-2815) (P)

*C. C. Moore*

SECRET ARMY ORGANIZATION (SAO), EXTREMIST MATTERS.

RE SAN DIEGO NITEL TO BUREAU, ATTN: LEGAL SECTION, 3-13-73.

ON 6-21-73, DEPUTY DISTRICT ATTORNEY FRANK SEXTON, OFFICE OF

THE SAN DIEGO COUNTY DISTRICT ATTORNEY, SAN DIEGO, CALIFORNIA,

ADVISED THAT ON THAT DATE JERRY LYNN DAVIS, FORMER LEADER OF THE

SECRET ARMY ORGANIZATION IN SAN DIEGO, WAS SENTENCED TO THREE

YEARS PROBATION PROVIDING THAT HE SERVE 134 DAYS IN THE CUSTODY

OF THE SAN DIEGO COUNTY SHERIFF, SAN DIEGO, CALIFORNIA, WHICH

134 DAYS HAVE ALREADY BEEN SERVED. ONE CONDITION OF HIS PRO-

VISION WAS A WAIVER OF SEARCH AND SEIZURE RIGHTS. DAVIS HAD

ENTERED A PLEA OF GUILTY TO A CHARGE OF POSSESSION OF EXPLOSIVE

MATERIALS BEFORE SUPERIOR COURT JUDGE FRANKLIN B. ORFIELD, SAN JUN 22 1973

SAN DIEGO COUNTY SUPERIOR COURT, ON 1-15-73.

EX-103

THE SECRET ARMY ORGANIZATION (SAO) IS AN ANTI-COMMUNIST, PARAMILITARY ORGANIZATION FORMED IN 1971 IN SAN DIEGO, CALIFORNIA.

*Mark*

END PAGE ONE

PAGE TWO

SD 157-2815

IT INTENDS TO CONDUCT INTELLIGENCE-TYPE OPERATIONS AND TO OFFER TRAINING IN URBAN GUERRILLA WARFARE TO BE USED AGAINST "LEFT-WING GROUPS" AND SUSPECTED ENEMIES OF THE UNITED STATES.  
ADMINISTRATIVE:

SAN DIEGO WILL ATTEMPT TO INTERVIEW JERRY LYNN DAVIS AND WILL SUBMIT LETTERHEAD MEMORANDUM. WILL CONSIDER SUBMITTING FD-122 RECOMMENDING DAVIS FOR ADEX.

END

cc MR. TRAINOR

# Memorandum

TO : ACTING DIRECTOR, FBI (157-23577)

DATE: 3/30/73

FROM: SAC, BALTIMORE (157-6675) (RUC)

SUBJECT: SECRET ARMY ORGANIZATION  
BALTIMORE DIVISION  
EXTREMIST MATTERS

Re Bureau letter to Baltimore dated 2/9/73.  
San Diego report of SA EARL M. PETERSON, 2/21/73, entitled  
"Secret Army Organization!"

Referenced Communication dated 2/9/73 pointed out that ~~INFORMANT~~ indicated that the Secret Army Organization (SAO) had begun to operate in Maryland, JESSE STEPHENS, HARRY BROCKMAN, VICTOR MANESS and JAMES WARD were identified as Maryland residents known to be associated with the SAO.

Investigation by the Baltimore Office through contacts with ~~INFORMANT~~ and additional sources has determined that above information was furnished to ~~INFORMANT~~ by JESSE STEPHENS who has contacted SAO, however has no organization in Maryland known as SAO. STEPHENS, as in the past, is attempting to spread this false information concerning the establishment of an SAO in Maryland to make himself feel important. In addition MANESS and BROCKMAN are on bond on a charge of murder stemming from the shooting of the boy friend of JAMES WARD's wife DOROTHY, and are not known to be members of any organization.

REC-91 157-23577-93

In addition, Baltimore presently has pending cases on JESSE STEPHENS, JAMES EDWARD WARD, HARRY BROCKMAN and DAVID VICTOR MANESS and in the event any information comes to the attention of the Baltimore Division concerning the SAO it will be immediately furnished to San Diego and the Bureau. In the event the SAO establishes an organization in Maryland, Baltimore will immediately open an investigation and conduct an active investigation as requested in referenced communication dated 2/9/73.

- 2 - Bureau REGISTERED MAIL
  - 2 - San Diego (157-2815) REGISTERED MAIL
  - 1 - Baltimore
- AEHG:cb 1573  
(5)

*Handwritten initials and signatures*

Buy U.S. Savings Bonds Regularly on the Payroll Savings Plan





NR 09 SD PLAIN

MAR 14 1973

10:41PM NITEL 3-13-73 GKF

TELETYPE

TO ACTING DIRECTOR (157-23577)

ATTENTION: LEGAL SECTION

FROM SAN DIEGO (157-2815) (P) 3P

Mr. Conrad	_____
Mr. Gebhardt	_____
Mr. Jenkins	_____
Mr. Marshall	_____
Mr. Miller, E.S.	_____
Mr. Sovers	_____
Mr. Thompson	_____
Mr. Walters	_____
Telo. Room	_____
Mr. Kinley	_____
Mr. Armstrong	_____
Mr. Bowers	_____
Mr. Herington	_____
Ms. Herold	_____
Mr. Minks	_____
Mrs. Neenan	_____

SECRET ARMY ORGANIZATION (SAO), EXTREMIST MATTERS.

RE SAN DIEGO NITEL TO BUREAU 2-26-73, CAPTIONED  
JERRY LYNN DAVIS, AKA, EM - SAO.

*je*

AT 9:20 AM ON 3-13-73, SA EARL M. PETERSEN, SAN DIEGO,  
 WAS SERVED WITH A SUBPOENA DUCES TECUM DIRECTING HIM  
 TO APPEAR IN SAN DIEGO COUNTY SUPERIOR COURT, DEPARTMENT NINE,  
 BEFORE SUPERIOR COURT JUDGE FRANKLIN ORFIELD, AT 10 AM ON  
 3-13-73, WITH BOOKS PAPERS, AND DOCUMENTS OR OTHER THINGS AS  
 FOLLOWS: "ALL POLICE, ARREST, AND OTHER REPORTS, PLUS ANY  
 AND ALL SECRET ARMY ORGANIZATION PUBLICATIONS AND PROPAGANDA  
 INVOLVING WILLIAM FRANCIS YAKOPEC, GEORGE MITCHELL HOOVER,  
 AND JERRY LYNN DAVIS." THIS SUBPOENA WAS PREPARED BY  
 END PAGE ONE

[REC-85

157-23577-92

MAR 14 1973

*[Handwritten signature]*

55 MAR 26 1973

MAR 1973

PAGE TWO

SD 157-2815

FREDERICK HETTER, ATTORNEY FOR DEFENDANT JERRY LYNN DAVIS,  
WHO IS SCHEDULED FOR SENTENCING ON 3-13-73.

ASSISTANT UNITED STATES ATTORNEY JOHN NEECE, SAN DIEGO,  
WAS ADVISED OF THE RECEIPT OF THE SUBPOENA AND HE AND SA  
PETERSEN APPEARED IN SUPERIOR COURT AS DIRECTED BY THE  
SUBPOENA. AUSA NEECE ADVISED THE COURT THAT, IN ACCORDANCE  
WITH ATTORNEY GENERAL'S ORDER 501-73 DATED 1-11-73 AMENDING  
TITLE 28 OF THE FEDERAL CODE SECTIONS 16.21 THROUGH 16.26,  
SA PETERSEN COULD NOT PRODUCE ANY RECORDS OR TESTIFY WITHOUT  
FIRST BEING AUTHORIZED TO DO SO BY THE ATTORNEY GENERAL OF  
THE UNITED STATES OR HIS DELEGATED REPRESENTATIVE.

BEFORE AUSA NEECE COULD RESPECTFULLY REQUEST THE COURT  
TO STAY THE DEMAND PENDING RECEIPT OF AUTHORITY FOR SA  
PETERSEN TO TESTIFY, JUDGE ORFIELD ENGAGED IN A DISCUSSION  
WITH ATTORNEY HETTER, AFTER WHICH HE QUASHED THE SUBPOENA  
WITHOUT FURTHER COMMENT FROM AUSA NEECE.

ON 3-13-73, SUPERIOR COURT JUDGE FRANKLIN ORFIELD, SAN  
DIEGO COUNTY, SENTENCED JERRY LYNN DAVIS TO A PERIOD OF NINETY  
END PAGE TWO

PAGE THREE

ED 157-2815

DAYS OBSERVATION AT THE CALIFORNIA STATE PENAL INSTITUTION  
AT CHINO, CALIFORNIA, AFTER WHICH FINAL SENTENCE WILL BE  
IMPOSED.

SAN DIEGO WILL FOLLOW AND REPORT FINAL SENTENCING OF  
MERRY LYNN DAVIS.

END

MT FBI WA

ACK 3 CLR

G-MR. MILLER

*copy sent to Mr. Trainor*

SAC, San Diego

3/7/73

Acting Director, FBI

1 - Mr. R. H. Ross

~~SECRET ARMY ORGANIZATION (SAO)~~

EXTREMIST MATTERS

BuFILE: 157-23577

SD FILE: 157-2815

NATIONAL SOCIALIST WHITE PEOPLES PARTY (NSWPP)

EXTREMIST MATTERS

BuFILE: 105-70374

SD FILE: 157-28

ReSDairtel 2/9/73 captioned **INFORMANT**  
EM - NSWPP."

Page four of referenced airtel states that on 10/17/72 informant advised that members of the NSWPP and SAO conducted joint target practice at the Gunsmoke Ranch and that informant provided a list of the participants.

Review of Bureau files in both these matters fails to disclose when this information was furnished the Bureau. If previously reported, advise caption and date of communication. If not reported to date, set out the details of the above-mentioned activity in an LHM under the dual caption. In the cover communication set forth what action is being taken to identify the participants.

RHR:fb (6)

NOTE:

MAILED 5  
MAR 6 1973  
FBI

REC-32 157-23577-91

18 MAR 9 1973

Informant justification communication set-out data regarding the joint participation in target practice by NSWPP and SAO members. Review of Bureau files fails to reflect details of this incident. Information should be disseminated in view of the association and the type of activity participated in.

54 MAR 10 1973

7 pwc

MAIL ROOM  TELETYPE UNIT

RECORDED COPY FILED IN 110-10700-1000

REPORTING OFFICE <b>SAN DIEGO</b>	OFFICE OF ORIGIN <b>SAN DIEGO</b>	DATE <b>2/21/73</b>	INVESTIGATIVE PERIOD <b>1/28/72 - 1/16/73</b>
TITLE OF CASE <b>SECRET ARMY ORGANIZATION</b>		REPORT MADE BY <b>SA EARL M. PETERSEN</b>	TYPED BY <b>lpo</b>
		CHARACTER OF CASE <b>EXTREMIST MATTERS</b>	

REFERENCE: San Diego report of SA STEVEN L, CHRISTENSEN, 1/21/72.  
 Baltimore letter to San Diego, 3/17/72.  
 Phoenix letter and LHM to the Bureau, 5/31/72.  
 San Diego airtel and LHM to the Bureau, 6/16/72.  
 Las Vegas letter to San Diego, 6/28/72.  
 San Diego airtel and LHM to the Bureau, 7/14/72.  
 Los Angeles letter to the Bureau, 8/16/72.  
 San Diego airtel and LHM to the Bureau, 8/18/72.  
 Seattle letter to San Diego, 8/29/72.

-P-

Deleted Copy Sent Double folder  
 by Letter 9/14/95 p. 2-4, 10, 21-23,  
 Per FOIA Request 47-58, 59 65, 67-91

ACCOMPLISHMENTS CLAIMED					<input checked="" type="checkbox"/> NONE	ACQUIT-TALS	CASE HAS BEEN:  PENDING OVER ONE YEAR <input checked="" type="checkbox"/> YES <input type="checkbox"/> NO PENDING PROSECUTION OVER SIX MONTHS <input type="checkbox"/> YES <input checked="" type="checkbox"/> NO
CONVIC.	FUG.	FINES	SAVINGS	RECOVERIES			

APPROVED S/AM SPECIAL AGENT IN CHARGE

DO NOT WRITE IN SPACES BELOW

COPIES MADE:  
 (8) Bureau (157-23577) (RM)  
 1 - U. S. Secret Service, San Diego (RM)  
 2 - Baltimore (157-6675) (RM)  
 2 - Kansas City (157-2179) (RM)  
 2 - Las Vegas (157-997) (RM)  
 2 - Los Angeles (157-7318) (RM)  
 2 - San Diego (157-2815)  
 (COPIES CON'T COVER PAGE 'B')

157-23577-91

REC 98

ST 101

FEB 26 1973

Dissemination Record of Attached Report	
Agency	<u>100 ISD, SS, CED</u>
Request Recd.	<u>←</u>
Date Fwd.	<u>2/3/73</u>

Notations

F-File

RAM

SD 157-2815

IDENTITY OF INFORMANTS

INFORMANTS

-----  
COPIES (CONTINUED)

- 2 - Phoenix (157-1173) (RM)
- 2 - Sacramento (157-2195) (RM)
- 2 - Seattle (157-1830) (RM)

-B-  
COVER PAGE

# INFORMANTS

## LEADS

Baltimore, Kansas City, Las Vegas, Los Angeles, Phoenix, Sacramento and Seattle will be alert for SAO activity and will report any such activity to the Bureau and San Diego.

## SAN DIEGO

Will follow and report sentencing of JERRY LYNN DAVIS, leader of SAO.

Will re-interview DAVIS after sentencing.

Will, through sources familiar with right wing activity, watch for any further SAO activity in San Diego.

## ADMINISTRATIVE

One copy of this report is being made available to United States Secret Service, San Diego, in view of their interest in this group who they consider a threat to the security of top officials in the United States.

Two copies of FD 376 are attached hereto.

All individuals mentioned herein are either being actively investigated or have been investigated in the past.

JERRY LYNN DAVIS was interviewed by SAS DWIGHT G. GARRETSON and EARL M. PETERSEN. Upon being interviewed, DAVIS stated he could not talk to the FBI without the consent of his attorney, FRED HETTER. He did however, furnish some information.

-C-  
COVER PAGE

Literature not contained in referenced San Diego report is contained in the appendix section of this report.

Information concerning a possible SAO source in the San Diego Police Department was immediately furnished to Sergeant JACK PEARSON and Detective RUBIEN BRANDON and considerable investigation has been conducted by the police department in an effort to locate this individual without success to date.

Information concerning SAO plans to assassinate individuals in the San Diego Police Department, Bureau of Alcohol, Tobacco and Firearms and Internal Revenue Service, all San Diego, California, were immediately relayed to these individuals and agencies.

Information concerning planned bombing targets by WILLIAM FRANCIS YAKOPEC was furnished to the San Diego Police Department Intelligence Unit when received.

The following information dealing with finances of the SAO is being set forth at this point in view of the political activity of LOUIS RAYMOND CONDE.

BARRY GODFREY and SAM DAVIS visited one LOU CONDE at San Diego, on January 28, 1972, to obtain help in the financing of the SAO. CONDE donated a complete military radio to the SAO and agreed to donate money personally and to get financial support from other persons who he feels will contribute. CONDE said he could put the SAO in touch with "Alpha 66" a Cuban refugee organization based in Miami, Florida, which is interested in liberating Cuba from its present government.

(HOWARD BARRY GODFREY,  
January 28, 1972)

LOUIS RAYMOND CONDE, 4980 Academy Street,  
San Diego, was elected to the San Diego  
County Board of Supervisors in November,  
1972.

-D-  
COVER PAGE



SD 157-2815

NON-SYMBOL SOURCE, ADMINISTRATIVE PAGE

SD T-2 is ~~CONFIDENTIAL SOURCE~~ San Diego Police Department who requested that his name be kept confidential.

The source in the Baltimore County Police Department is ~~CONFIDENTIAL SOURCE~~ of the Baltimore County Police Department, Intelligence Division.

-E\*-  
COVER PAGE



## FEDERAL BUREAU OF INVESTIGATION

In Reply, Please Refer to  
File No.

WASHINGTON, D.C. 20535  
February 21, 1973

Director  
United States Secret Service  
Department of the Treasury  
Washington, D. C. 20220

RE: SECRET ARMY ORGANIZATION

Dear Sir:

The information furnished herewith concerns an individual or organization believed to be covered by the agreement between the FBI and Secret Service concerning protective responsibilities, and to fall within the category or categories checked.

1.  Threats or actions against persons protected by Secret Service.
2.  Attempts or threats to redress grievances.
3.  Threatening or abusive statement about U. S. or foreign official.
4.  Participation in civil disturbances, anti-U. S. demonstrations or hostile incidents against foreign diplomatic establishments.
5.  Illegal bombing, bomb-making or other terrorist activity.
6.  Defector from U. S. or indicates desire to defect.
7.  Potentially dangerous because of background, emotional instability or activity in groups engaged in activities inimical to U. S.

Photograph  has been furnished  enclosed  is not available.

Very truly yours,

L. Patrick Gray, III  
Acting Director

1 - Special Agent in Charge (Enclosure(s)) 1  
U. S. Secret Service, San Diego

Enclosure(s)

APPENDIX

San Diego, California

February 21, 1973

In Reply, Please Refer to  
File No.

Title SECRET ARMY ORGANIZATION

Character EXTREMIST MATTERS

Reference Report of SA EARL M. PETERSEN  
dated and captioned as above  
at San Diego.

All sources (except any listed below) whose identities are concealed  
in referenced communication have furnished reliable information in the past.

*This document contains neither recommendations nor conclusions of the FBI. It is the property  
of the FBI and is loaned to your agency; it and its contents are not to be distributed outside your  
agency.*

UNITED STATES DEPARTMENT OF JUSTICE  
FEDERAL BUREAU OF INVESTIGATION

Copy to: 1 - United States Secret Service, San Diego (Registered Mail)

Report of: SA EARL M. PETERSEN Office: SAN DIEGO  
Date: February 21, 1973

Field Office File #: SD 157-2815 Bureau File #: 157-23577

Title: SECRET ARMY ORGANIZATION

Character: EXTREMIST MATTERS

Synopsis: The Secret Army Organization (SAO) Headquarters and San Diego Chapter have reportedly ceased to exist as a result of arrest and prosecution of members and associates in San Diego, California, and because it has been revealed that HOWARD BARRY GODFREY was a source within the SAO who was reporting information concerning the SAO to the FBI. MEMBERS AND ASSOCIATES OF MEMBERS OF THE SAO SHOULD BE CONSIDERED ARMED AND DANGEROUS IN VIEW OF THE NUMEROUS WEAPONS AND EXPLOSIVES FOUND IN THEIR POSSESSION AND BECAUSE THEY HAVE USED BOMBS AND HAVE BEEN INVOLVED IN SHOOTINGS IN THE PAST.

-P-

DETAILS:

AT SAN DIEGO, CALIFORNIA

The Secret Army Organization (SAO) is an anticommunist, paramilitary organization formed in 1971 in San Diego, California. It intends to conduct intelligence-type operations and to offer training in urban guerrilla warfare to be used against "left-wing groups" and suspected enemies of the United States.

This document contains neither recommendations nor conclusions of the FBI. It is the property of the FBI and is loaned to your agency; it and its contents are not to be distributed outside your agency.

U. S. GOVERNMENT PRINTING OFFICE: 1970 O - 406-1

I. ORGANIZATION STRUCTURE

On October 8, 1972, JERRY LYNN DAVIS, leader of the Secret Army Organization (SAO) who is generally known as SAM DAVIS, advised that the SAO is now "dead" as far as San Diego is concerned.

(SD T-1, October 8, 1972)

During late October, 1972, JERRY LYNN DAVIS stated that because of court proceedings against SAO members in San Diego, California, the SAO has become a defunct organization. A small pocket of SAO members continue to exist in Los Angeles, California, and two members remain in the Seattle, Washington, area. The unaffected elements may possibly band together but under a different label.

(SD T-1, October 27, 1972)

On January 16, 1973, JERRY LYNN DAVIS was interviewed by Special Agents of the Federal Bureau of Investigation (FBI) at San Diego, California. He advised that the SAO is now no longer active because of the arrests of members in San Diego and because of the demoralizing effect of learning that HOWARD BARRY GODFREY was reporting to the FBI concerning the activities of the SAO and its members. He said San Diego had been the headquarters of the SAO. Both the National Headquarters and the San Diego Unit of the SAO have ceased to exist. The only remaining group of SAO members might possibly be a small group operating independently in Los Angeles, California, under a leader who DAVIS would not identify.

DAVIS said he is completely disenchanted with right-wing activity and will no longer participate in such activity. He intends to cooperate fully with law enforcement agencies. He complained that when he was arrested recently, only one or two of his "right-wing friends" stood by him. He intends to move out of the State of California and live in Mississippi where he has relatives.

HOWARD BARRY GODFREY, for a number of years, voluntarily furnished the FBI information regarding the identities and activities of extremist groups in the San Diego area. His information has been reliable and as an interested citizen, he volunteered his knowledge and services to local law enforcement agencies which culminated in his appearance and testimony before the San Diego County Grand Jury in June and July, 1972.

II. SUMMARY OF ACTIVITY

On January 6, 1972, two shots were fired into the San Diego home of radical professor PETER BOHMER injuring a guest in his house. These shots were fired by SAO member ✓ GEORGE MITCHELL HOOVER using a 9mm automatic pistol.

(HOWARD BARRY GODFREY,  
January 12, 1972)

On February 22, 1972, a number of posters reflecting that President NIXON is wanted for treason and containing a photograph of President NIXON were posted on power poles in El Cajon, California. At the bottom of the poster next to a symbol representing the cross hairs in a rifle sight were the words, SECRET ARMY ORGANIZATION.

(SD T-2, February 22, 1972)

On June 19, 1972, a bomb exploded in the Guild Theatre, San Diego, California. This bomb was planted by SAO member WILLIAM FRANCIS YAKOPEC. ✓

(HOWARD BARRY GODFREY,  
June 20, 1972)

WILLIAM FRANCIS YAKOPEC plans to place bombs in the following establishments which he believes to be places offering pornographic entertainment:

- "The In Crowd", Santee, California;
- "The Academy Theatre", San Diego, California;

"The Pussycat Theatre", San Diego, California;  
"The Bedroom", San Diego, California

YAKOPEC indicated that he might attempt another bombing within a few nights.

(HOWARD BARRY GODFREY,  
June 20, 1972)

WILLIAM FRANCIS YAKOPEC stated he had been under surveillance for the past two days but he feels the surveillance has ended. He said he has decided to bomb "Genies Massage Parlor", El Cajon, California, on the evening of June 23, 1972. He asked his neighbor, HOWARD GODFREY, to accompany him. He later said he has decided to postpone this bombing because of the surveillance on his home.

(HOWARD BARRY GODFREY,  
June 23, 1972)

On June 25, 1972, YAKOPEC advised that because of the continuing surveillance he had decided to conceal some explosives he had in his residence under a pile of scrap lumber located in a vacant lot behind his residence. He then left for Los Angeles, California, where he was to leave his wife with relatives.

The explosives consisted of one 2 1/4 pound block of C-4 military plastic explosive; two one pound canisters of Du Pont HPD primer charges; about 30 electric caps in a canister; a quantity of black safety fuse, and a trip lever from a kit used to convert an M-1 military carbine to the fully automatic M-2 version.

(HOWARD BARRY GODFREY,  
June 25, 1972)

Sergeant JACK PEARSON, San Diego, California, Police Department advised on June 25, 1972, that the vacant lot behind the YAKOPEC residence had been searched and the above described items had been confiscated.



On June 27, 1972, Detective RUBIEN BRANDON, San Diego Police Department advised that on the basis of information furnished by HOWARD BARRY GODFREY, warrants were secured on June 26, 1972, for searches of the residences of WILLIAM FRANCIS YAKOPEC and known SAO member GEORGE MITCHELL HOOVER and a close associate, RICHARD FLEURY. These warrants were executed on the evening of June 26, 1972, and large quantities of SAO and Minutemen literature dealing with explosives and construction of mines and booby traps was confiscated at the home of WILLIAM FRANCIS YAKOPEC. Fourteen assorted weapons were confiscated at the residences of HOOVER and FLEURY including a 9mm automatic pistol, a .22 caliber magnum derringer and assorted rifles and shotguns as well as several thousand rounds of assorted ammunition for the weapons. Approximately fifty pounds of gunpowder was seized at the FLEURY residence. As a result, YAKOPEC, HOOVER and RICHARD and GENEVIEVE FLEURY were placed under arrest by the San Diego Police Department.

The Minutemen is a paramilitary group organized in June, 1960, by Robert B. DePugh in Norborne, Missouri, as a resistance to the spread of communism in the United States by use of guerrilla tactics. DePugh is currently incarcerated in a Federal penitentiary for violation of the Federal Firearms Act.

The Patriotic Party has been the political arm of the Minutemen.

On June 29, 1972, JERRY LYNN DAVIS stated that a source in the San Diego Police Department advised him that there was an informant in the FBI and that the police department knew of plans by WILLIAM FRANCIS YAKOPEC to commit additional bombings. Targets have been "staked out" by the police and that officers surveilling his, YAKOPEC's, home had been advised that he is a psychopath.

(HOWARD BARRY GODFREY,  
June 29, 1972)

On June 30, 1972, JERRY LYNN DAVIS, stated that a member of the SAO had volunteered to take revenge for the arrest of SAO members in San Diego. He did not reveal the identity of the volunteer. His plan calls for the assassination of persons believed to be involved in the arrest of the SAO members. Individuals mentioned as targets for the assassin are Chief of Police RAYMOND HOEBLER, Inspector WILLIAM GORE and Detective RUBIEN BRANDON, all of the San Diego Police Department; STEVE LOGAN, Bureau of Alcohol Tobacco and Firearms, and possibly the head of the Internal Revenue Service in San Diego, California. SAO members were instructed by DAVIS to gather intelligence information concerning home addresses and other information concerning persons picked as targets.

(HOWARD BARRY GODFREY,  
July 1, 1972)

On July 7, 1973, Detective RUBIEN BRANDON, San Diego, California, Police Department advised that JERRY LYNN DAVIS was arrested by the San Diego Police Department for possession of explosives and for receiving stolen property.

On July 12, 1972, the San Diego County Grand Jury, San Diego, California, returned indictments against WILLIAM FRANCIS YAKOPEC, GEORGE MITCHELL HOOVER and RICHARD and GENEVIEVE FLEURY.

On July 18, 1972, the San Diego County Grand Jury returned an indictment against JERRY LYNN DAVIS. A second indictment was returned on ROBERT MAYER, JR., SAO member for perjuring himself during the Grand Jury hearing on July 12, 1972.

On July 22, 1972, Detective RUBIEN BRANDON, San Diego Police Department, advised that on the previous day a search warrant was served on the residence of VAHL BOYLES, 4443 Upland Street, La Mesa, California, by the San Diego Police Department. Mrs. BOYLES is the mother of TROY HAUGHTON, former leader of the Minutemen Organization in San Diego who mysteriously disappeared in 1967.

A substantial quantity of military drugs, medical supplies, explosive paraphernalia and Minutemen literature was found buried beneath the BOYLES' residence.

On July 24, 1972, Detective BRANDON, San Diego Police Department, advised that on the previous day a search warrant was served at the home of SAO member HOWARD FRANCIS CLARK, 1080 6th Street, Ramona, California. CLARK was arrested by the San Diego Police Department for possession of explosives, possession of illegal tear gas and receiving stolen property. Thousands of rounds of military ammunition were seized as well as deactivated land mines, assorted mortar rounds, numerous rifles and hand guns and SAO literature.

On July 24, 1972, THOMAS FORREST, a San Diego gun dealer and close associate of SAO members was arrested for the sale of several illegal weapon conversion kits to an undercover San Diego Police Officer who accompanied HOWARD BARRY GODFREY to the gun shop operated by FORREST. He was arrested by Special Agents of the Bureau of Alcohol, Tobacco and Firearms.

On July 24, 1972, Detective BRANDON, San Diego Police Department advised that San Diego County Sheriff's Investigators seized a cache of weapons and explosives in the Cuyamaca Park area, California. The cache contained a flame thrower, land mine fuzes, a quantity of explosives and primer fuses of the type used in the bombing of the Guild Theatre in San Diego.

On August 10, 1972, Detective BRANDON, San Diego Police Department advised that on the previous day an authorized search was conducted at the home of WILLIAM FRANCIS YAKOPEC at which time illegal inflammable material was found. Mrs. DEBORAH YAKOPEC, wife of WILLIAM FRANCIS YAKOPEC, was arrested and charged with possession of explosives. An additional similar charge was lodged against WILLIAM FRANCIS YAKOPEC, at that time incarcerated in the San Diego County Jail.

On September 25, 1972, San Diego County Superior Court Judge GILBERT HARELSON dismissed charges against RICHARD and GENEVIEVE FLEURY inasmuch as the information on which the search warrant for their residence was based failed to substantiate the reliability of sources who provided the information on which the warrant was based.

On October 2, 1972, WILLIAM FRANCIS YAKOPEC was found guilty in the San Diego County Superior Court, San Diego, California, on charges of igniting and exploding a destructive device; assault with intent to commit murder; simple assault; assault with a deadly weapon on a police officer, and possession of explosives near a habitation.

On October 10, 1972, Investigator LAWRENCE WILSON, San Diego County District Attorney's Office, San Diego, California, advised that CALVIN HENDELL FOX, alleged SAO member, was on that date indicted by the San Diego County Grand Jury, San Diego, for perjury committed during the trial of WILLIAM FRANCIS YAKOPEC. FOX testified that he was not a member of the SAO and that HOWARD BARRY GODFREY had talked to him about the bombing of the Guild Theatre at FOX's gasoline service station on the morning of June 20, 1972; that GODFREY did not personally deliver to him his membership certificate in the SAO and that such documents first appeared in his files at the service station after FBI Agents visited the station. FOX was arrested on that same date.

Investigator WILSON advised on October 10, 1972, that one DINO EDWARD MARTINELLI, who testified in the trial of WILLIAM FRANCIS YAKOPEC, that he had advised the FBI of the whereabouts of a large number of arms stolen from the Camp Pendleton Marine Base, Oceanside, California, two years ago and that he sold a large quantity of these guns to HOWARD BARRY GODFREY, was indicted on October 10, 1972, by the San Diego County Grand Jury for perjury in the YAKOPEC trial. At the time of the indictment, MARTINELLI was already incarcerated in the San Diego County Jail on other charges. MARTINELLI was not a member or an associate of the SAO.

On October 24, 1972, Investigator WILSON advised that WILLIAM FRANCIS YAKOPEC was sentenced on October 24, 1972, to one year to life for assault with a deadly weapon on a police officer and to four other sentences of one to five years to run concurrently on other charges which included assault with intent to commit murder; igniting and exploding a destructive device; possession of other than fixed ammunition; and possession of explosives in or near a place of habitation. Before sentencing, YAKOPEC admitted to Superior Court Judge ROBERT W. CONYERS that he had lied on the witness stand when he denied he had bombed the Guild Theatre.

On November 3, 1972, Investigator WILSON advised that WILLIAM FRANCIS YAKOPEC had on that date entered a plea of guilty to a lesser charge of possession of inflammable material with intent to burn as a result of the search of his home on August 10, 1972. He was sentenced to a one to five year term in the state prison to run concurrently with the one year to life sentence previously received by him. His wife DEBORAH YAKOPEC was, on the same date, allowed to enter a plea of guilty to a lesser charge of disturbing the peace. She was fined \$20.

On November 14, 1972, RICHARD FLEURY severely beat his wife GENEVIEVE. She was rushed to the hospital where surgery was necessary to correct nerve damage.

(HOWARD BARRY GODFREY,  
November 14, 1972)

On November 30, 1972, Investigator WILSON advised that on November 29, 1972, in San Diego County Superior Court, HOWARD FRANCIS CLARK was sentenced to three years probation and fined \$1,000 after entering a plea of guilty to possession of illegal ammunition.

On December 1, 1972, Investigator WILSON advised that on that date, GEORGE MITCHELL HOOVER was found guilty on all counts by the San Diego County Superior Court.

SD 157-2815

On December 4, 1972, Investigator WILSON advised that DINO EDWARD MARTINELLI entered a plea of guilty to perjury in the YAKOPEC trial in the San Diego County Superior Court, San Diego, California.

ON December 6, 1972, Investigator WILSON advised that on December 6, 1972, CALVIN HENDELL FOX was found guilty in the San Diego County Superior Court, San Diego, California, on the perjury charges resulting from his testimony in the trial of WILLIAM FRANCIS YAKOPEC.

DEBBIE EGLEY, Clerk, Records Section, San Diego County District Attorney's Office, advised on December 29, 1972, that CALVIN HENDELL FOX was sentenced on December 22, 1972, in the San Diego County Superior Court, San Diego, to five years probation and six months in custody with credit for time already served. This sentence resulted from his perjury in the YAKOPEC trial.

On January 3, 1973, Investigator WILSON advised that on January 2, 1973, GEORGE MITCHELL HOOVER was sentenced in the San Diego County Superior Court, to five years to life in prison on three charges resulting from the shooting into the home of radical professor PETER BOHMER. HOOVER had been charged with assault with a deadly weapon; firing into an occupied dwelling and possession of a billy club.

On January 9, 1973, Investigator WILSON advised that on January 4, 1973, in the San Diego County Superior Court, DINO EDWARD MARTINELLI was sentenced to one to fourteen years in the California State Prison after entering a plea of guilty to committing perjury in the YAKOPEC trial. Superior Court Judge FRANKLIN B. ORFIELD advised MARTINELLI that his name had not been properly changed and that his true name continues to be RICHARD EDWARD BRADLEY rather than DINO EDWARD MARTINELLI.

On January 15, 1973, Investigator WILSON advised that on January 15, 1973, in the San Diego County Superior Court, JERRY LYNN DAVIS entered a plea of guilty to a charge

of possession of explosive materials. Sentencing was set for February 26, 1973. A charge of receiving stolen property was dismissed.

III. ACTIVITIES OF LOCAL GROUPS

AT BALTIMORE, MARYLAND

Sources in Baltimore, Maryland, who are in a position to furnish information concerning white extremist activities advised during February and March, 1972, that JESSIE CLAYBURN STEVENS, who operated the Minutemen Organization there, had formed an alliance with the SAO.

A source in the Baltimore County Police Department who is in a position to be aware of white extremist activity in the Baltimore area advised during March, 1972, that he has heard of no SAO activity in that area.

AT KANSAS CITY, MISSOURI

Sources in Kansas City, Missouri, who are in a position to be aware of white extremist activity advised in December, 1971, and January, 1972, that the SAO is not known to be active in that area.

AT LAS VEGAS, NEVADA

Sources in Las Vegas, Nevada, who are in a position to furnish information concerning white extremist activity have furnished no information indicating that the SAO is active there.

AT LOS ANGELES, CALIFORNIA

Sources in Los Angeles, California, who are in a position to furnish information concerning SAO activity stated on August 3, 1972, that no such organization as the SAO exists in the Los Angeles area.

AT PHOENIX, ARIZONA

The state coordinator of SAO activity at Phoenix, Arizona, has been instructed to include the State of New Mexico in recruiting efforts for the SAO.

(SD T-1, May 10, 1972)

In Arizona the SAO has mailed a considerable amount of literature pertaining to the SAO to "conservative" thinking people, but has not at this time received response from the type of people they wish to affiliate. Consequently, no formal chapter or nucleus around which to organize has been formed in Arizona. However, a coordinator has been named and is operating. Not all former Minutemen will be accepted into the SAO.

The SAO foresees a decentralized type of operation in each state, where in a revolutionary situation brought about by treasonous communist elements, the SAO could present a militant front immediately. Recent bulletin material from SAO Headquarters in San Diego has introduced the thought that "the basic battle facing our country today is the one between individualism and collectivism. In its political form it appears as personal freedom versus police-state regimentation.....In times of emergency, our members are not going to depend on General Headquarters for training material, bulletins and printed propaganda items. Local units and often the lone individual will have to improvise all these things. Communications to and from higher commands may be uncertain and the transmission of organization orders may be slow. We must have people who think for themselves. Equally important, we must have people who can see what needs to be done and get at it without being told."

(SD T-1, May 26, 1972)



AT SACRAMENTO, CALIFORNIA

When interviewed by Special Agents of the FBI on January 16, 1973, JERRY LYNN DAVIS, SAO leader, stated that there has never been any SAO unit or activity in Sacramento, California.

AT SEATTLE, WASHINGTON

During June and August, 1972, sources in Seattle, Washington, advised that no known SAO activity had occurred in that area.

IV. FINANCES

The SAO has received \$300 to \$400 in donations, membership applications fees and monthly dues. Most of this money has been spent on printing costs and postage.

(HOWARD BARRY GODFREY,  
March 8, 1972)

The SAO intends to use the following breakdown of money contributed to units of the SAO outside of San Diego.

Dues \$3.00 per month, \$2.00 kept by the receiving unit and \$1.00 to be forwarded to headquarters at San Diego.

Membership \$5.00, \$3.00 to be retained and \$2.00 to be sent to headquarters.

Contributions of members sent in to the unit accompanying report forms, half to be kept by the unit and half to be forwarded to headquarters.

Any other contribution is retained by the unit receiving it.

(SD T-1, March 21, 1972)

The SAO has a policy of retaining sufficient funds in the hands of the various unit coordinators to allow them to operate as independent organizations. The only expenses

SD 157-2815

incurred at SAO headquarters has been the printing of bulletins and rental of post office boxes.

(SD T-1, May 10, 1972)

V. MISCELLANEOUS

Appended hereto are copies of literature printed and/or distributed by the SAO.

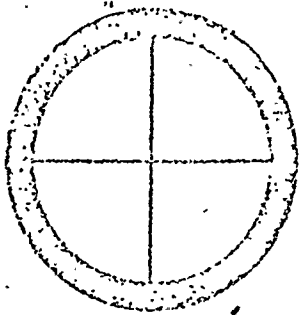

# SECRET ARMY ORGANIZATION

## UNDERGROUND BULLETIN

GENERAL HEADQUARTERS — JANUARY 1972

"God grants liberty only to those who love it and are always willing to guard and defend it". Daniel Webster

Fellow members,

This month's bulletin will deal mostly with "Booby Traps". Because of the length of this article we are only sending out the first half this month. The second half will be published in next month's bulletin. Future bulletins this coming year will contain material on psychological warfare, urban warfare tactics, communications, survival equipment, first aid, explosives, weapons, codes, and other related warfare subjects.

Those members who have not yet completed or started on the organization's basic training programs are hereby urged to do so. We cannot, in most cases, assign any member to an important underground project or to an organized team or group until they have completed this training program.

While headquarters cannot assign a member in the above classification to an established unit, any member can (and is encouraged to) recruit and form their own combat team (see December 1971 Bulletin). In many cases this may be the best policy in regards to personal security as the member would be working with the people he personally knows and trusts. If any member would like to form their own unit they should write to their assigned mail drop and the organization will send them further instructions along with a Team Recruiting Packet. The article on "The Dispersed Team" in this month's bulletin should help those members who wish to form their own Combat Team.

We are enclosing a small number of S. A. O. stickers with this month's bulletin. Please put them in your shirt pocket or billfold and as soon as possible stick them up in phone booths, at bus stops, or other public places that you visit. The stickers are already gummed and when wet will adhere firmly to glass, metal, or any other smooth surface. If our members would use these stickers along with the leaflets that are available, it would have a real psychological impact on the rest of the American people and give them evidence that there are still those among them who are willing to fight for the re-establishment of a Constitutional Republic. These first stickers are being sent to each member free, additional stickers and leaflets may be ordered on the monthly report form.

When discussing a Secret Army Organization "Combat Team", we usually think of a small group of people who live very close to one another. Such an arrangement has certain advantages, such as ease of communication and travel for collective training and team operations, but there are also several disadvantages.

Among the disadvantages are these: Team members may be well acquainted with only a small geographical area. If forced to leave this area the team may be placed at a serious disadvantage. It is harder for a team of SAO members who live closely together to keep from attracting attention, thus unit security may be poor. If one member of the team is ever discovered and arrested by the enemy, chances are that all members of the team will be rounded up together.

These considerations have caused us to experiment with a new arrangement that we refer to as a "Dispersed Team". Such a team has the same number of members (usually six) as a regular Combat Team. Each team is split into two sections as is the old team. The members have the same type of individual specialties and duties.

The big difference lies in the fact that the team members may be located over a comparatively larger area - perhaps as much as 25 to 30 miles in diameter. In urban areas one team member may live in each of six different cities. Thus the team may range over a fairly large geographical area with at least one team member being familiar with the immediate territory through which they are traveling.

When active as part of an underground movement (as opposed to the classical forms of guerrilla warfare) the Dispersed Team has several other advantages. For example, if one member of the team gets too "hot" in his area, he automatically has five other hide-outs to which he can go for assistance or to which he can send his family for temporary safety. The Dispersed Team can conveniently cover a larger area in the fields of recruiting, psychological warfare, and propaganda. Operations of sabotage, surveillance and harassment of communist personnel, raids, and other combat type operations can be successfully conducted while moving a minimum of people over a minimum distance.

During the present period of deliberate delay the activities of the team will naturally be different from some future period in which all out warfare between our organization and our country's communist enemies develops.

If the team is to achieve its ultimate objectives the following activities must be provided for: (1) organization of and within the team, (2) communications between the team and higher command, (3) maintaining secrecy of team members, (4) maintaining a continuous and effective propaganda effort, (5) obtaining the necessary supplies and equipment for present and future needs, (6) training of the team in general, and of individual members in their own specialties.

When the required personnel are not available to form a full team, a three man section should be formed. When additional people are recruited the unit can then be expanded in an orderly fashion.

## BOOBY TRAPS

Broadly defined a booby trap can be any kind of apparatus in which a reaction unfavorable to the enemy is brought about when he unintentionally makes some act which triggers the reaction. The most common types of booby traps used in warfare involve an explosive charge which is set off by movement of a trip wire or the moving of some object which is connected to the trigger mechanism.

On occasion the explosive charge may be replaced by signal flares, gas, smoke or other chemical agents. The trigger mechanism may be either electric, mechanical, thermal or chemical.

**ELECTRICALLY OPERATED TRIGGERS.** Such trigger mechanisms are very easily arranged wherever a supply of electric blasting caps are available and also a suitable source of electricity. One of the most common electric type booby traps is to simply interrupt the electrical circuit in some building so that when the lights are turned on the explosive is detonated. This simple procedure applied to an automobile with a few sticks of dynamite has marked the end of more than one gangland hoodlum. To booby trap a car in this manner one side of the electric blasting cap can be attached to any metal part of the car while the other side is attached to a spark plug or the "cold side" of the ignition switch. In the first case the cap detonates the dynamite when the starter motor is turned over or if attached to the key switch detonating occurs when the ignition is turned on.

Any movable object can be booby trapped so that when it is moved some simple type electrical switch contact is placed to complete a circuit between a dry cell battery and the detonator. A very simple example would be to have one wire tacked along the edge of a door and the other wire tacked to the frame and extending out far enough that contact is made between the two when the door is opened. A slightly more refined trigger involves two small springs separated by some thin piece of insulation at one end as shown in Figure No. 1. When pressure is applied, the springs are held apart and when the pressure is released, the springs come together to make electrical contact. This may be placed in a door which is then closed to open the switch while the explosive is wired into the circuit. When the door is opened pressure is released and the charge explodes.

This simple trigger can be placed under the leg of a chair, a wooden box or any other movable object of sufficient weight. If the chair is moved or the box lifted the release of pressure will close the electrical circuit.

A person skilled in the placement of booby traps will not leave any part of the switch, wires or charge visible. Instead of

connecting the wires to the door itself he will take off the door frame, place the trigger mechanism at the edge of the door and then replace the frame so that the entire mechanism is hidden when the door is closed.

By taking off the frame of a window and drilling a hole out through the window casing the trigger mechanism can be placed so that the charge will be detonated by either raising or lowering a half open window.

A simple time delay mechanism can be arranged by placing one of these triggers under a glass jar filled with water. When enough of the water evaporates, the weight of the jar will no longer be sufficient to hold the contacts open.

Figure No. 2 shows another simple electrical trigger made from a spring clothes pin. The improvised contacts are held apart by a small wooden wedge in the jaws of the clothes pin. This wedge can be attached to a trip wire or other movable object. When it is withdrawn the clothes pin shuts and the electric circuit is completed.

A trigger of this type can be used to make a time delay mechanism in many different ways. The wedge may be connected by a loose cord to the end of a spring which is also attached to a tin can. Above this a second tin can full of sand or water is placed with a hole in the bottom so that the contents gradually fall through into the second can. When the weight of the lower can becomes enough to stretch the spring sufficiently the wedge will be pulled from the clothes pin. As an alternate method the spring may be already stretched out and held there by a second cord attached to some other solid object. The cord holding the spring could be placed through a candle so that it will be burned in two when the candle burned down a certain distance. An active imagination can devise countless ways for activating this type of trigger either by instant action or delayed action.

A clever derivative of this simple trigger is used in the "British book trap". In this case a book is hollowed out to contain a small battery and a quarter pound block of TNT which is detonated by an electrical blasting cap. The circuit passes through two contacts attached to opposite pages of the book but are held apart by some insulating material which is attached to the back of the bookcase. If the book is withdrawn from the case the contacts come together and the TNT is detonated.

A British ball bearing contact switch is shown in Figure No. 3. This type of contact is very useful in placing charges entirely within a movable object. For example, a suitcase could be laid on its side with the contact positioned inside in such a way that when the suitcase was picked up the ball bearing would roll forward and complete the contact. Similar electrically activated booby

traps could be placed in closed gasoline cans, canteens, ammunition boxes or dozens of other objects which an enemy would place right side up before opening. A plastic or glass test tube could be used instead of a metal case by sticking two wires through the cork in such a manner that the ball bearing would come in contact with both of them.

A surprisingly accurate timing device can be made with a tube of this type. Holding the tube with the open end up, first pour in a quantity of dried peas, then a measured amount of water, drop in the ball bearing (in this case a wad of tin foil could be used as well), finally put the cork in the top with the wire sticking down through. The water will cause the dried peas to swell which will push the ball bearing (or wad of tin foil) up until it makes contact with the two wires to complete the circuit. The time can be regulated from a few minutes to several hours depending on the length of the tube, the amount of water, and the quantity of peas used.

Far more sophisticated types of electrical triggers are manufactured some of which operate by photoelectric cell or even more difficult to recognize mechanisms. These may be used to safeguard record centers, important military or missile bases, etc. but are seldom encountered under battlefield conditions.

**MECHANICAL TRIGGERS.** These may be operated either by impact or by friction. The ordinary hand grenade employs an impact trigger. When the handle is released a spring operated lever snaps against a cap (similar to the priming cap in a shotgun shell) which in turn starts a short fuse to burn. This fuse leads to a blasting cap centered in an explosive charge.

The trigger mechanism of a "potato masher" hand grenade operates much like the firing pin of a bolt action rifle. In this case a spring activated plunger strikes a detonator. The plunger may be released by pulling out a pin as shown in Figure No. 4, by cutting a wire as shown in Figure No. 5 or by applying pressure to a slotted key as shown in Figure No. 6.

Explosion of the primer cap alone is not sufficient to detonate most military explosives. Generally a booster charge of a fairly sensitive explosive is detonated by the primer and this in turn detonates the main charge. In military use TNT is by far the most common explosive used in the main charge of booby traps. So called "plastic explosive" or "Composition C-3" contains 78 percent RDX and 22% plasticizer made up of mixture of dinitrotoluene, TNT, nitrocellulose and dimethylformamide. RDX is cyclotrimethylenetrinitramine which is manufactured by nitrating hexamethylenetetramine (which is obtained by the reaction of formaldehyde and ammonia).

Booster charges where necessary are usually tetryl or PETN. Common explosives used in primers are lead azide, lead styphnate

or the now largely discontinued mercury fulminate. Characteristics, uses and manufacture of explosives will be dealt with in another chapter.

A very simple device can be made from a screen door spring that will explode an ordinary rifle cartridge when activated by a trip wire. Although the "explosion" is almost harmless it can be very nerve racking to an approaching enemy.

A more deadly booby trap consists of a short piece of pipe which is driven into the ground. A plunger type trigger mechanism is dropped into the pipe and an ordinary rifle cartridge placed point up in the pipe so that perhaps one-half inch is exposed above the ground. The weight of a man stepping on the bullet releases the trigger and fires the cartridge which will penetrate wall up into the leg or the body.

Some mechanical triggers are activated by friction just like striking a match on the rough material of the match cover. Figure No. 7 shows a cut-away drawing of the U.S. Army firing device, pull friction type M-2. The coated wire is covered with a gritty substance much like the strip on a book of matches. When this is pulled out through a container of flash compound (chemically similar to the match heads) the friction ignites the flash compound which may be used either to light a fuse or fire a blasting cap.

A crude but effective friction device can be prepared by sticking the end of a fuse in some small cylinder filled with match heads through which is placed a small strip of tin or heavy cardboard with a friction strip from match books glued to both sides.

In field use the friction type ignitor can be hidden in many ways connected with trip wires or attached to movable objects to set off either instant or delayed charges.

**THERMAL IGNITORS.** In some cases the ignitor, (fuse or primer) can be used as a trigger mechanism. For example in World War II the Germans were known to tear down fireplaces and cement them back together with hidden charges that would ignite when a fire was built. A simple hand grenade or mortar shell hidden in a hollow log by a burned out fire would, of course, explode if the log were used as fuel without being inspected.

A common trick is for a retreating army to leave behind coal oil lamps or lanterns filled with gasoline. An unthinking person who touches a match to such a lantern will nearly always be burned to death.

**CHEMICAL TRIGGERS.** These are more frequently used in the construction of time bombs than in booby traps. Figure No. 8



shows an Italian chemical delay igniter. The upper chamber contains acetone. When the piercing pin is pushed downward it penetrates the lead disc and allows the acetone to flow into the lower chamber. The acetone gradually dissolves the celluloid washer which holds back the striker. The time delay can be varied by placing different numbers of cellophane washers on the striker rod.

In several similar types of delayed mechanisms the striker is held back by a thin metal wire which is gradually dissolved when a solution of acid is allowed to surround it.

Other types of delay mechanisms may be constructed where a liquid is allowed to drop through a small hole into a lower container having a reactive substance attached part way up one wall. The liquid level in the chamber gradually raises until it comes in contact with the reactive substance which is the igniter. One suitable combination is sulfuric acid for the liquid and a mixture of potassium chlorate and sugar for the solid. Another suitable combination is plain water for the liquid and metallic sodium for the solid. There are many other combinations which a chemist might improvise from materials at hand.

There are some explosives so sensitive that they can be used as trigger mechanisms. Ammonium tri-iodide can be made from ordinary household ammonia and iodine crystals. If the iodine crystals are not available they can be obtained by evaporating sufficient volume of tincture of iodine in a flat glass dish.

Place two or three teaspoons of iodine crystals in a piece of kieselguhr and wet thoroughly with strong ammonia solution. A small amount of ammonia may be added from time to time making certain that it does not have the chance to dry out. After three or four tablespoons of ammonia solution have been absorbed and partly evaporated from the iodine it can be left to dry out. While wet ammonium tri-iodide is reasonably safe to handle. When dry, it is so sensitive that it detonates at the slightest touch. It may be exploded by a person walking on a wooden floor several feet away or a door being closed in the same building. The amount described above will produce a violent explosion and should be treated with extreme caution. Several similar compounds will be mentioned in the chapter on explosives.

One or two teaspoonfuls of mercury fulminate of silver fulminate mixed (very gently) with ten percent coarse sand can be placed in a small pocket of paper and attached to the upper side of an automobile tire with adhesive tape. When the tire rolls over it the fulminate will explode with sufficient power to destroy even a husky truck tire. These combinations also are very dangerous to handle.

## READY MADE BOOBY TRAPS

All national armies are supplied with a variety of manufactured trigger devices, charges, etc. to be used specifically as booby trap material. Most firing devices are threaded on one end with a standing size that allows them to be used either with prepared charges or with improvised charges made from mortar or artillery shells. Figure No. 9 shows a simple firing device attached to a hand grenade.

An antipersonnel mine of French manufacture is shown in Figure No. 10. The apparatus at the left side is a trigger mechanism that can be operated by a trip wire. When it is fired the flash passes through the "U" tube which propels a 60mm grenade into the air and at the same time ignites a 1/5 second delay pellet. The grenade explodes a few feet off the ground to shower metal fragments over a wide area. Total weight of mine is 5-1/2 pounds.

Guerrilla bands have sometimes used artillery shells or mortar shells in demolition work by placing them in a large pile of wood or other combustible material and building a bond fire around them until they exploded. For booby traps use, however, the projectile of an artillery shell is the only part of any value. Useful sizes include 75mm, 90mm, 105mm, and 155mm. In those artillery shells where the projectile is attached to the case, it is generally best to remove the projectile and discard the case. Artillery shell projectiles may be fused either in the nose or in the base. For most efficient use, the regular fuse must be unscrewed and a standard firing device (M10 Universal destructor) put in its place.

## IMPROVISED BOOBY TRAPS

Standard hand grenades can be used alone in booby traps in a number of methods. The simplest is to carefully remove the handle and wedge the grenade between two heavy objects strong enough to hold the spring in the cocked position.

Another trick is to cover a hand grenade with wet mud with just the safety pin ring sticking out. After the mud has hardened, it will hold the handle in place and the safety pin ring can be withdrawn. These harmless looking clumps of mud scattered along a dirt road will, of course, break open when hit by an automobile tire which will release the handle and fire the grenade. A similar trick is to place grenades in glass jars tight enough to hold the handle in place when the safety pins are withdrawn. At night these may be strung on a wire across a road and may not be seen by a car traveling at night with its lights off. When the bottles break the grenade handles are released and they soon explode.

It seems doubtful that man's ingenuity will ever be exhausted when it comes to improvising traps of various types. A rusty nail stuck to a board left where it will be stepped on by a running enemy may be just as deadly to that one individual as an atomic bomb. Open pits (sometimes with sharp stakes at the bottom) covered with flimsy camouflage is much older than the bow and arrow, but were still used by the Japanese in World War II.

"Dead falls" made from heavy tree limbs that fall when a victim releases them by tripping over a jungle vine can still be useful in guerrilla warfare.

Leaving behind poisoned food or bottled drinks is common. Alcoholic drinks are easily diluted with wood alcohol (temporary type antifreeze) equal to 1/4 their content of ethyl alcohol without detection. A total intake of 2 or 3 ounces will cause blindness or death in a few hours. Soft drinks can be easily poisoned with ethylene glycol (permanent type antifreeze) at the rate of 2 ounces per bottle. This dose is usually fatal and once symptoms develop there is no known antidote.

When five parts of potassium permanganate is mixed with one part of powdered sugar it forms a combination that will either explode (if confined) or burn with a flash if ignited in the open. A new idea might be to put three or four tablespoonful of this material in an ash tray covered with a thin dust of cigarette ashes. The first person to put his cigarette out in that particular ash tray would be burned bad enough to be out of commission for quite some time. Black powder, if available, would actually explode if used in this way.

#### USE OF BOOBY TRAPS

It is obvious that the use of booby traps favors an army in retreat, and one of their greatest uses is to slow down pursuit. For most efficient use the laying of booby traps must be done in a planned and coordinated method. When time permits the entire area to be booby trapped should be reconnoitered and the placement of available material planned in such a way as to confuse the enemy, impede his progress and cause maximum number of casualties.

Generally speaking a large number of small booby traps are preferred to a few large ones. Two or more triggers may be attached to a single charge. Variety of types and settings is essential to effective use of booby traps in large numbers.

In the event that friendly troops or your own personnel may re-enter such an area later on, it is desirable that a written record and detailed maps be kept as to where booby traps are placed. When U.S. Army troops discover a place that is booby trapped they mark it with a sign which consists of a red triangle

pointed downward with a white circle in the middle and the word booby traps painted in white across the top.

When anti-vehicle mines are placed by regular army forces it is common practice to booby trap the mines so they will explode when being removed by personnel attempting to clear the area.

The use of booby traps is very adaptable to both guerrilla and counter-guerrilla activity. Guerrilla warfare involves two basic types of action: ambushes and raids. When the guerrillas ambush regular army forces, they are the ones that will make use of the booby traps. In raiding an enemy garrison or supply depot they must beware of booby traps that the regular forces have placed to protect their fixed positions.

The ambush may start when the leading vehicle of an enemy column strikes a mine or drives on to a bridge which is dynamited. Perhaps time delay booby traps activated by the first vehicle in the column may be used to destroy other vehicles several positions behind. Troops riding in a truck convey may be expected to seek cover in ditches beside the road or other points of natural protection. If these ditches have been booby trapped beforehand, they will be killed in the very process of seeking shelter.

Before making any raid on a fixed enemy position, guerrilla forces should carefully consider the potential danger of booby traps. When regular army forces are being harrassed by guerrillas they may be expected to leave supplies badly needed by the guerrillas in slightly protected warehouses as traps. These supplies may be heavily booby trapped and counter guerrilla forces may be waiting a short distance away to take pursuit. To guard against these things, the guerrilla should attempt to keep their target under surveillance for several hours or days before making the raid. They should observe the coming and going of enemy personnel. If the enemy is very careful to always come and go by the same route it may mean that other routes are booby trapped. If the supplies are not added to or taken from regularly, this may indicate that they are being used to bait a trap. By scouting the general area guerrilla forces should guard against surprise by other enemy forces waiting within danger distance.

After making either a raid or an ambush, guerrilla forces should place booby traps behind them to slow up pursuit. Real booby traps can be interspersed with imitation traps. To be safe the enemy will have to go around or de-activate the imitations and take just as much time doing so as if they were real. If the enemy becomes careless in handling your imitation traps, he will run the danger of getting killed by a live one. In planning the path of their retreat guerrilla forces should booby trap alternate routes which enemy forces might use to cut them off.

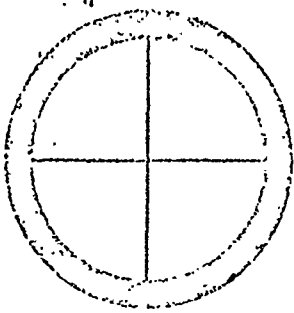

# SECRET ARMY ORGANIZATION

## UNDERGROUND BULLETIN

GENERAL HEADQUARTERS

MARCH 1972

"He who accepts evil without protesting it is really cooperating with it."

— Thoreau

### organizing your underground group

The most effective underground movements are built step-by-step. They begin with intelligence networks and the dissemination of propaganda. Gradually the movement includes passive, then active sabotage. Finally it develops into full time underground warfare. There may be times when surprise attack or special circumstances may require immediate armed resistance but such resistance cannot be fully effective until the intelligence and propaganda services can be developed to an equal extent. If proper sources of information are developed prior to military action many possible traps and expensive mistakes can be avoided.

Once a country is at war or occupied by an enemy, recruiting new underground members is a very hazardous occupation. Suspicion and fear lie like a blanket over the people. Neighbors are afraid to be seen talking together. Even friends become guarded in their talk.

These are the reasons why we advocate forming your group now - while you can still do so in comparative safety. It is like insurance purchased in hopes that you will never collect. If the need for active combat never comes this will still not be time wasted. You will surely gain true friends. You will surely profit by a better understanding of your neighbor's point of view. You will certainly add to your appreciation of the courage and dignity of your fellow Americans.

It is best if your group can be made up of people who have known each other previously and who already respect one another's ability and loyalty. Unfortunately this is not always possible. So long as personal existence is possible most people will try to "exist" under the yoke of slavery. Only here and there will you find a person with the courage and conviction to join in active resistance against the enemy.

The communists are well aware of these facts. They are constantly trying to ferment distrust among the peoples of the free world. Even here in the United States many intelligent and responsible people are losing their confidence in one another, in their

law enforcement agencies and in their government itself. This is not said with the intention of being hypercritical. It is merely a statement of fact.

During the past thirty years our nations "foreign policy" has repeatedly played right into the communist's hands. As a result one free nation after another has been handed to the reds on a silver platter. Time and time again these "mistakes" have been concealed from the people or have been white-washed by persons in high government office. How can anyone blame the American public for beginning to wonder?

All too often people who have tried to call attention to these facts have themselves been smeared as "fascists", "extremists", and worse. The following is quoted from the American Legion Magazine, November 1961:

"Although Americans generally have no use for communism, many protest vigorously whenever an attempt is made to expose or discredit communists. . . . No sooner is an anti-communist organization launched than it is attacked, hissed at and spat upon. The same is true of INDIVIDUALS from the moment they assail the twin evils of communism and communists.

Why do so many Americans join the never ending campaign to discredit and destroy those who are fighting their battles against communism for them and in the process, risking their reputations, their livelihood, their health, and even their LIVES. How is the phenomenon of perversity to be explained?"

How indeed? Yet this situation does exist and added to the suspicion that has developed among our countrymen, it makes people reluctant - even afraid - to exercise their rights of free speech and peaceable assembly.

During the past few years thousands of "study groups" and similar anti-communist organizations have come into existence. As those who belong to them know, many people are "too busy" even to inform themselves as to the true nature of the communist-socialist menace. With this in mind you might imagine it would be very difficult to get people to spend their own money for arms and then get them out in the open where they can train in the use of such arms.

Strangely enough, we have found it much easier than you might think. It may be that people have developed a sense of futility about writing their congressmen or working for political candidates (presidents come and presidents go but the old bureaucracy just keeps rolling along).

Since World War II billions of words have been spoken by the negotiators and the propagandizers in the "cold war". Still the free world is losing steadily. The people have lost faith in words. Few believe in the power of words anymore.

If you approach them in such a way as to prove that you are yourself sincere, you will

find among your own acquaintances many who are tired of talk and who will be glad to find some constructive action which they can enter into.

AS YOU FORM YOUR OWN GROUP KEEP THESE FACTS IN MIND:

(1) The underground needs all kinds of people, young and old, men and women. Those who the enemy "could never suspect" can act as spies and messengers. The underground needs many different things in addition to fighters: sources of supply, lines of communications, a multitude of skills that can be supplied by many different kinds of people.

(2) To voluntarily start training in the use of arms, especially in the absence of a declared state of war, requires a deep personal conviction that this must be done now for the salvation of ourselves and our country. If you do not believe this yourself you will never be able to pass the necessary conviction to other members of your group.

(3) A small group that is resolute and dedicated will be more effective than a large group containing people that may doubt the importance of their cause.

For a battalion of men to attack the enemy in the face of gunfire requires courage. For one or two men to fight alone in the dark requires bravery. For the wives of such men to spend the night waiting and wondering requires even greater bravery. These are the type of people you MUST collect about you.

It is natural for living things to want to keep on living. The kind of bravery we are talking about is not something people are born with. It is something that a person must develop within himself. It comes only from the absolute belief that our cause for freedom is more important than anything else in this world.

Where can you find such people? You find them among your neighbors, among the people you work with, among your friends and your relatives. You might never guess it as you move among these people in their daily lives but there are countless numbers of Americans who share this belief with you.

This does not mean that such people are going to be immediately enthusiastic about forming an underground. Some may, but others may never have had an opportunity to learn the true facts about our national and international situation. That's where you come in. You must be able to convince such people that they cannot afford to wait until the last minute before they get prepared.

To convince others you must first be sure of your own facts. The organization has several pieces of literature available which exposes the communist threat inside America as well as books on guerrilla warfare.

Remember, the formation of a group should first start with intelligence and propaganda. Don't mistake what we mean by "propaganda". Some people have the idea that this re-

fers only to information that is false and misleading. Propaganda refers only to the use of information to attract people to your way of thinking. Truth is the best possible kind of propaganda.

Here then are the step-by-step suggestions on how to go about forming your own group:

1. Know the truth. Be able to back up your view of the current situation with facts and references.
2. Make a list of everyone you know even casually: friends, fellow workers, neighbors, lodge or church members and relatives.
3. Renew old acquaintances. Get to really know these people. Feel them out on current events, politics, and world affairs. Let them know where you stand.
4. Do not choose people just because you think they would be willing to join your group. Choose instead those that you want in your group. Remember that if fighting actually starts these people will be closely associated with you and themselves for long periods of time. Eliminate the braggarts. Pick the quiet confident people that won't get on each others nerves when the going gets tough.
5. After you have decided on a list of five to twelve people you are ready to give them your "sales talk". You can do this with each one individually or you can get them together as a group for this purpose. If you talk to them singly you can maintain a greater degree of secrecy about other members of the group.

Group discussion has the advantages that each prospect is more likely to take your viewpoint seriously if he is sitting down among other people who seem to be taking it seriously also. Since you won't be taking up anything too secret during your first two or three meetings, there will be plenty of time to eliminate any doubtfuls, or more likely, they will eliminate themselves.

6. Whether you talk to your prospective group members singly or as a group, your first discussion should convince them of these things:
  - a. That the free world is losing the cold war against communism.
  - b. That as things are now going we will keep right on losing and that sooner or later Americans may be forced to defend their own property and their own families by whatever means are still available to them.
  - c. That your small group may not be able to do anything to change this situation but in any event you should get together regularly for at least a few meetings to examine any possibilities that may exist.
  - d. Be willing to admit that things may not actually be as bad as you believe but get your prospective group members to at least admit that they owe it to themselves to discover the facts.



- c. Get your prospects to do some reading. Loan them books and pamphlets. Use anti-communist and U.S. Government literature to back up your own arguments.
- f. By all means set up a definite place and schedule for future meetings.

7. If you decide to begin the organization of your group by having them all meet together for your "rules talk" here are some additional points that have proven effective many times in the past for other members.

- a. Hold the meeting in your own home if possible. Otherwise, reserve a room in one of the downtown hotels or motels well ahead of time.
- b. Give your prospects an invitation at least two weeks ahead of time and ask them to confirm at least a week before the meeting that they will be there.
- c. Do not tell them exactly what the meeting is about except that it is a matter of "mutual importance". They should be told that if they come it must be with the understanding that they will arrive on time and will not leave before the meeting is over.
- d. Where a married person is invited the invitation may include both husband and wife and they should both be urged to attend if at all possible. If one is absent he or she will not understand the importance of the project and may object to the time or money which the other will spend on future activities.

8. When you get your group together, start the meeting off promptly and in a business like manner.

It is certain that there will be a lot of questions about your plans and objectives. If you are organizing as an affiliate of the organization, they will want to know more about the parent organization: how and why it was formed, and they will need to be convinced that they are not going to be considered radicals for entering into this preparation.

Here is where your own knowledge and skill is all important. You must assure them there is nothing illegal about this activity. We are urging them to act only as individuals under their own constitutional right of free speech, peaceable assembly and the right to own and bear arms.

If you feel that your group is not completely sold on your presentation, it may be best to postpone much discussion of the organization until a second meeting.

After your first small group is formed further members should be recruited on a selective basis. In this way you may include the many different skills needed without the size of the group getting too large. By each member having a special task to do their interest and enthusiasm will be maintained at a high level.

Remember that an underground needs many things in addition to fighters. Your fighters alone without proper equipment, supply lines, and community support would soon be surrounded, arrested and eliminated. In addition to your fighting group members who

all know each other, you should enlist the assistance of many other people who are sympathetic to your cause and willing to help in their own way although they should know no more about your members or operations than necessary to gain their cooperation. They will form an auxiliary force to work with the individual group member who is responsible for their special activity.

The group leader, if he is to successfully maintain his position must by one means or another make certain that all six of these activities are provided for.

#### ORGANIZATION:

The organization of the group is primarily the responsibility of the group leader. He must interview personally each new prospective member and make certain that they are suitable material. This means more than simply being loyal to the United States. The prospective member must be impressed with the fact that he is undertaking a grave responsibility. He must be made to understand that even though he has joined the group on "faith" rather than from complete knowledge of its overall activity, that withdrawing from the group will not be easy and that if he should in the future withdraw from the group that he will ever after be considered as suspect by the other group members. The prospective group member must be a type that will get along well with other people. He must not be a braggart or a show-off. Under no circumstances must he become intoxicated or loose-mouthed. He must be a willing worker and ready to assume his share of the load.

The group leader should determine the skills and interest of his members. He should talk over with them the various tasks that need to be performed and ask for volunteers until each member has a responsibility that they are interested in and that they are capable of fulfilling. Since membership in the organization is essentially voluntary the group leader cannot force any member to perform any activity against his will and should not attempt to do so. When a member assumes responsibility for a certain field of activity he must realize that he will be expected to fulfill that task successfully regardless of any other conditions that may arise. If a member is unwilling to assume responsibility on this basis, he should be given another responsibility that better fits his capabilities or should be gracefully eased out of the organization.

#### INTELLIGENCE:

Intelligence includes all types of information that may be of value at either the national or local level. Scraps and bits of information that may seem of little value alone may eventually fit into a pattern that will someday provide important information for either defensive or offensive action, either propaganda or open warfare.

The group member in charge of intelligence should enlist the assistance of several non-combatants to help gather this information. One or two of these should read all the local and regional papers carefully every day. It's surprising how much information can be picked up from these sources concerning individuals that may be active in communist front activity. If one or more members of the group are union members, they should provide the union papers for examination.

Other auxiliary members should take part in church and Y.A. activities to guard against communist infiltration in these areas. A reading and study group should be set up to study school textbooks and teaching methods in your area for collectivist-socialist-communist slanting.

An auxiliary member should carefully evaluate all of the "Letters to the Editor" that appear in various papers in the area. Those who express especially patriotic sentiments and those who are outspoken in their defense of the American constitution and way of life should be turned over to the recruiting officer who can contact them as potential members or auxiliary members. Those who advocate collectivism in any form should be turned over to the security officer who can look up their full names, addresses, etc., and file them away among the potential turncoats.

The intelligence officer should evaluate all the information sent to him by his auxiliary members to determine the sentiments of people in his area especially those in politics or in a position to influence other people. He should pass on to the regional headquarters any information that involves national or international figures or organizations where in turn it will be compiled with other information and sent on to the national headquarters.

#### SECURITY:

The security officer must be responsible for secrecy within the group and about the group. We have learned that those members whose membership or identity becomes known will in all probability be subject to abuse and harrassment from the liberals and communists. Therefore, one major duty of the security officer is to prevent the identity of the group's actual members from becoming known.

He should also review from time to time the methods of communications between members of the group. He should insure the secrecy of the meeting places and the training sites. He should arrange for at least two or more secret addresses for receipt and delivery of mail between groups and particularly the regional coordinator. He should be careful that the amount of mail, frequency of meetings, number of parked cars and similar circumstances do not draw attention to the group or its activities.

One of the security officers most important projects is to arrange for a number of "safe houses". These are people both in city and rural areas who have no contact with group members at all and who are quite ordinary in their daily life and yet have a strong sympathy for the organization. They must be willing to care for wounded members or provide hiding places for group members that have been discovered by the enemy. If the communists take over this country from within it is quite possible that the underground and its members will be declared outlawed and it is also possible that individual members may be "feamed" with false charges. To hide out a fugitive under these conditions would require a great deal of faith as well as courage. Unfortunately a great percentage of the great American public has neither. Even so, the obtaining of such refuge houses may be essential to the groups ultimate survival and must be arranged for at all costs. Only the group leader, the intelligence officer and the security officer should know the location of these "safe houses" except for the individual member who may put the group in touch with individual locations.

## PROPAGANDA:

Until such time as fighting might actually break out we must expect to engage in a continuous propaganda warfare against the communists, communist sympathizers and dupes within our borders. Our ultimate victory or defeat may depend on the outcome of the propaganda battles that we are fighting right now.

By planted newspaper articles and by slanted programs over radio and TV the enemy is even now trying to "smear" us out of existence. They are also starting an all-out campaign to outlaw the use and ownership of firearms by civilians.

During the cold war period the propaganda officer should act as a public relations man for the organization in his locality. It is important that this individual make a good personal appearance and be able to speak and write well. Without actually admitting that he is a member of the organization, he can still contact various news media, television, etc. and ask them to find out the true facts about the organization before blindly repeating half truths and insinuations that come over the wire services or that they read in other papers and magazines..

Whenever local papers carry articles detrimental to the organization, he should have all members, auxillary members, their friends, relatives, and associated groups flood that paper, radio or TV station as the case may be with both signed and unsigned letters demanding a retraction,

In cases where some particular news media makes a habit of slandering the organization or when some particular news commentator or TV personality does so repeatedly, then the organization should write repeatedly to the companies that place advertising with them to demand a retraction.

Articles or comments which are actually libelous should be forwarded to the regional headquarters for investigation and the possibility of law suits against the offending persons.

The propaganda officer should prepare himself to speak publicly and should arrange to give talks to various civic organizations on the importance of the citizen's right to self defense.

## RECRUITING:

The recruiting officer should discuss with other members of the group what additional skills are needed and with their help should attempt to enlist the assistance of people who have such skills. He should cooperate with the security officer to determine whether or not prospective members are loyal to their country and have ideals in keeping with our organization. He should receive from the intelligence officer names of prospective members or associates and contact them to evaluate their possible usefulness to the group. If new groups or new group members are recruited through advertising, he should work with the propaganda officer to prepare effective material. A recruiting officer should make a special effort to enlist the cooperation of a reputable attorney to advise the group as to its legal rights and defend these rights in court if necessary. With other members in the group the cooperation of a doctor should also be arranged for.

Together with the security officer he should attempt to find a printer locally who will supply the group with literature on an absolutely confidential basis. All of the other members of the group should be contacted by the recruiting officer and passed on by the security officer after checking any information known about the prospective member with the intelligence officer.

#### MEDICAL:

This man may be a doctor or one skilled in first aid. In the latter case, he should make contact with a physician who will work with the group to provide necessary drugs, medical supplies and confidential assistance in time of need.

This member will also be responsible for obtaining medical supplies and keeping adequate reserves on hand. He should give consideration to the general health of all group members and should encourage each member to maintain a maximum degree of physical fitness for their age and circumstances. A medical officer should make all group members keep on hand a large amount of special drugs or medicine each member must for his health.

#### COMMUNICATIONS:

This member of the group should have or obtain a working knowledge of all radio equipment, field telephone, codes and signals. If he is not an amateur radio operator himself, he should work with the recruiting officer to enlist the aid of one or more amateur radio operators either as group members or as associates. He should be responsible for pass words and other words of identifying friendly supporters. He should arrange suitable code phrases by which essential information can be given over the telephone between group members without giving it away in case the phone is tapped.

#### ARMAMENT AND DEMOLITION:

The armament officer, with the assistance of other group members should see that all of the groups equipment is safe to use and kept in good repair. He should have sufficient knowledge of firearms and weapons to instruct other members in their use and maintenance. He may designate other members to become specialists in certain types of weapons and so forth.

At least one group member should make himself an expert in the use of all types of explosives, booby traps, time fuses, and similar material. In cooperation with the armament officer and other group members he should determine both immediate and future needs and sources of such materials along with means to obtain such items and also the raw materials from which these items can be quickly manufactured.

#### SUPPLIES:

The supply officer should keep in mind that the organization has no legal status except their rights as individuals. Group ownership of firearms or supplies could be con-

strued as raising an army which would be a violation of the law. Although he may coordinate the stock piling or obtaining of material, it must be clearly understood by all that each individual item is owned by some individual member. The supply officer is primarily responsible for the storage of reserve materials.

Each group should prepare a number of escape and evasion kits. These should be of three types:

1. A very small kit which each member can carry on his person.
2. A suitcase size kit that can be kept in the car or home at all times.
3. An inexpensive kit that can be buried at strategic places or hidden in other strategic localities.

#### TRAINING:

The training schedule may be arranged for by the group leader or he may elect to assign this responsibility to a training specialist. In either case an inventory should be made of the various skills, talents, and knowledge of each member. All members should discuss together the thirty different parts of the initial training program. They should divide these sections up among themselves so that some member can read and study each subject prior to the training session and be prepared to instruct the other members in his own speciality.

#### FINANCES:

Although the individual group members must be self sustaining as far as their individual equipment is concerned, there will be many expenses that must be met collectively. To fight the propaganda war requires printing, postage, travel, and so forth. Although the individual group members may be able to meet this expense to a minimum degree they will not in most cases be able to finance the maximum effort that is required. The finance officer should therefore consult with the other group members as to means of raising additional money. One possible source will be from people who will agree with the aims of the organization in theory but who are unwilling or unable to take an active part in the program. Such people may be willing to set up a series of regular monthly contributions to help finance our fight against communism.

In small groups one member may have to double up on two of these duties. In larger groups, the division of responsibility may be spread among a greater number of individuals and still other duties may be assigned to individual members.

The important thing is to meet regularly and discuss your mutual problems. If each member has a job he is interested in and keeps busy at, morale will stay high and you will really get things done. Without such team work the group members will soon lose interest and become discouraged.

There are a great many ways in which women can be a valuable aid to the group either

as members or associates. Each group should obtain by means the part time service of one or more secretaries who can type up literature to be printed, articles to the newspapers, communications between groups and so on. Much of the intelligence work can be handled by women. They can assist the propaganda effort by handing out literature, giving talks to women's clubs, PTA associations and so forth.

It is felt that it would be a mistake to set down hard and fast rules for the group's conduct and activities. To do so would run the risk of making each group a carbon copy of every other group and possibly of stifling individual ingenuity. One of the greatest advantages that an underground has is the simple fact that the enemy never knows what he is up against.

The group leader must continually merit the respect and confidence of his members. This respect is the only means he has of maintaining discipline. Before taking any action, all members of the group should have an opportunity to voice their opinions. But it must be mutually understood that when the discussion is over, the group leader must make the final decision. His decision must be complied with and in return for the compliance, he must bear responsibility for the groups ultimate failure or success.

Past experience has shown that the successful underground leader must possess certain minimal qualifications:

1. He must have a strong personal conviction as to the righteousness of the cause for which he is fighting.
2. He must have the ability to infuse other members of his group with this same conviction.
3. He must be able to exercise effective command over his group through personal loyalty and political enthusiasm when no other means of discipline are available.
4. He must be able to keep secrets and organize even quite important actions so that as few people as possible know his plans.
5. He should be a born conspirator, capable of deceiving not only the enemy but even his members of his own group if this is necessary to insure absolute security.
6. He must be able to act inventively and imaginatively so as to constantly seize the initiative away from the enemy.
7. He should have risen to his position of leadership through his own abilities and execution.
8. He should be physically vigorous and self-denying so that he can accommodate himself to primitive surroundings.
9. He should have no addictions or strong habits that might distract him at some crucial moment.

10. He must have the bulldog tenacity to see that important tasks are completed no matter what difficulties or obstacles may be placed in his path.

11. He must have the patience to remain inactive when such is the best course and to wait for exactly the right time to strike.

12. He must have the moral courage to accept full responsibility for his own actions and those of his group.

You should think these requirements over carefully. How do you measure up? It's best if we admit our weak spots to ourselves and start now to strengthen ourselves for the trials ahead. With advance preparation, self-discipline and a firm resolve we can meet the test.

The human race is much inclined to wishful thinking. Even though the communists have told us that they will never rest until they have conquered the whole world, most people will not allow themselves to even consider this possibility. As war clouds gather on the horizon, most people focus their attention all the more on other things and hope that if they just ignore the threat of war it will somehow disappear.

When the time for underground warfare suddenly comes there will be a hundred civilians wanting to fight for every one that is trained or equipped to do so. Under these conditions each member of our organization and similar groups that are making ready for this emergency will surely find himself acting as leader of an underground group. As a part of your self-training it is thus necessary to give some thought as to how you can quickly train new recruits, how you can maintain discipline and security. In short, you must give some serious advance thought as to your own abilities and possible short-comings as an underground leader.



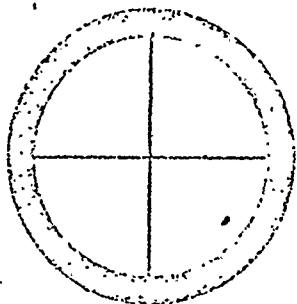

# SECRET ARMY ORGANIZATION

## UNDERGROUND BULLETIN

---

GENERAL HEADQUARTERS

APRIL 1972

---

"A tyrant would not come to the United States from across the sea. If he comes, he'll ride down Pennsylvania Avenue from his inauguration and take up "legal" residence of the White House." Abraham Lincoln

Fellow members,

The main subject that will be covered in this month's bulletin will be the forced entry into buildings, as it applies to underground warfare. A two page article on the use of ammonium nitrate as an explosive is also covered in this bulletin.

We have several points that need to be covered in this bulletin and not much space if we are to keep our postage bill within reason. On the surface, the lives of the American people seem to be going on about the same as usual. So long as most of them have enough to eat and a few luxuries of life, they continue to ignore the undercurrent of treason within our own borders which is rapidly washing away the foundations of our American Heritage.

Those who have taken the time to inform themselves as to the true conditions realize that our country is rapidly reaching a point of no return in its downhill fight against the forces of freedom.

The time is past when the SAO can consider any but a military answer to the problems that face our country. We must act as quickly as we can to develop internal discipline and definite chains of command. If we are going to be a fighting unit, then we must be ready to fight when the time arises.

If we less those among our organization who are unable to face reality or unwilling to make the sacrifice necessary to add to our strength rather than to detract from it, then the organization as a whole will be better off for it.

New combat teams, groups, and networks will be forming within the next 90 days. Assignment of new members to these new units will be made as soon as they have finished their basic training programs. All teams and groups are urged to expand their local units and keep them active on constructive local projects.

## THE USE OF AMMONIUM NITRATE IN HIGH EXPLOSIVES

Ammonium nitrate is a common fertilizer used on farms throughout the United States and most foreign countries. It is readily available from farm agencies, general stores, fertilizer companies, etc. in most farming communities.

Most people know that ammonium nitrate can be used as the basis for various high explosive mixtures. Little information has been available as to the best proportion, uses and means of detonating these mixtures.

Depending on the method of manufacture ammonium nitrate may occur as irregular grains, flakes, small crystals or so-called "prills". Any of these types can be used but prilled ammonium nitrate is most efficient. Fortunately, the prilled type is also the most common.

Explosive mixtures may be made by mixing ammonium nitrate with such organic compounds as fuel oil, powdered coal, lamp black, etc. It is quite possible that powdered sugar, starch, and many similar compounds could also be used but further experimentation is needed. Ammonium nitrate itself is extremely difficult to detonate.

The most common and probably the best all round mixture consists of 94% prilled ammonium nitrate and 6% fuel oil. In this case the term fuel oil can include No. 2 diesel fuel, kerosene, light lubricating oil, etc. The only requirements are that it be thin enough to be readily absorbed by the rather porous prills of ammonium nitrate and on the other hand it must not be so volatile as to evaporate easily.

The amount of fuel oil can vary from 2% to 13% and the mixture will still explode provided that a strong detonator is used. Maximum explosive force is achieved between 5% and 6%. These percentages are figured by weight. Presumably the best percentage of lamp black or finely powdered coal would be approximately the same.

Because these mixtures are comparatively insensitive they all require a rather strong explosive to start the detonation. In nearly all cases a one pound stick (2x8 inch) of 60% dynamite will suffice. The dynamite itself must, of course be detonated by a suitable blasting cap. One stick of 40% dynamite does not have enough power to detonate an ammonium nitrate-fuel oil mixture reliably. If this is all that is available, three sticks tied together should be used.

The shape as well as the size of the detonator has an effect. For example, if an eight inch stick of dynamite is cut into four inch pieces and these are tied together it effectively decreases the length and increases the diameter of the detonating charge. This will increase its reliability over that achieved by a single eight inch stick.

Several other factors affect the efficiency of AN-FO (ammonium nitrate-fuel oil) mixtures. Among these are the amount of explosive used in a single charge, degree of confinement, moisture content, particle size temperature, etc.

AN-FO mixtures are commonly used in mining rock or ore from large open pits. In this application, holes are drilled back into the rock and the AN-FO mixture is poured into the holes. Normally, the ammonium nitrate and the fuel oil are carried separately to the mine and are mixed together just before they are used. The holes into which the AN-FO mixture is poured are usually several feet long. In this case the diameter of the hole has considerable effect on the explosive force generated. A hole diameter less than three inches will not explode with sufficient force to carry itself along the bore hole. The maximum detonation velocity requires that the bore hole be at least six inches diameter.

In using smaller amounts of AN-FO mixtures the charge should be kept approximately equal in its length, width and depth. In practical application a container about the size of a five gallon gas can is as small as can be used. Charges the size of a 55 gallon drum can provide much more explosive force in proportion to their weight. A small amount of AN-FO requires just as strong a primer to detonate as does a larger amount.

Close confinement is required to achieve maximum explosive force from AN-FO mixtures. In mining operations the rock surrounding the charge provides this confinement. To be exploded above ground the AN-FO mixture should be confined in an iron pipe not less than three inches in diameter and preferably larger. Since these mixtures are "pushing" type explosives rather than "shattering" types they must be properly placed to achieve useful results.

Suppose the objective was to destroy a large bridge. A dozen five gallon cans of AN-FO mixture are available to do the job. If these are set in the middle of the bridge or between the girders and "exploded" little if any real damage will result. In this case, a tunnel should be dug through the dirt behind the concrete abutment at one end of the bridge. Depending on the width of the bridge all twelve cans of explosive could be packed tightly together or they could be spaced three to four feet apart. In either case each can should be provided with its own primer and all the primers should be tied together with two lengths of prima cord.

Moisture content of the ammonium nitrate is very important. This chemical absorbs moisture from the air quite easily. After being mixed with the fuel oil it is protected from this to a considerable extent. For maximum explosive effect the AN-FO mixture should contain no more than 4% water and if the moisture content exceeds 7% it may not explode at all. If it is suspected that the AN-FO mixture may be damp, double the size of the detonator.

For military use, suitable charges could be made from dry ammonium nitrate mixed with the proper amount of fuel oil and then placed in water tight containers. These containers should provide some means of quickly placing the detonator into the approximate center of the charge just before it is to be used. The usual cost of ammonium nitrate is about \$5.00 per 100 pounds.

## FORCED ENTRY OF BUILDINGS

In this bulletin we shall study this subject as applicable to underground warfare. In our advanced training lessons we will deal with more specific subjects such as picking, pick guns, key impressing, etc.

We feel that every guerrilla fighter and every underground member for that matter should at least be familiar with the fundamentals of quickly gaining entry to buildings occupied by the enemy.

Our attention is directed toward the speed and noise of the entry with little regard to the damage done. In later lessons we will deal with the more discreet methods of entry. The 007 type movies and TV have glamorized and distorted the entry of locked buildings the same way they have done weapons and ballistics. It is no more unreal to quickly dial your way through a 4 tumbler combination lock in 30 seconds than it is to fire 250 rds from a BAR after you have loaded it with an 8rd Garand clip. They have done both on TV!

Basically a lock does 2 things. It makes the intruder make noise and expend time. There is no such thing as a burglar proof locking device or building. Some are just more difficult than others.

### LOOK FIRST FOR EASY AND OBVIOUS WAYS OF GAINING ENTRY.

Some examples are given:

1. It is surprising how many people hang an expensive pad lock on either a cheap hasp or a hasp that has been installed with the screws exposed. Only a screwdriver is needed to get through this set-up.
2. First make sure that the lock is actually locked! Don't waste your time forcing an unlocked door! Don't laugh it has been done. Many times people will set the lock but not shut the door hard enough for the latch to drop into the striker plate.
3. One of the quickest ways past a pad lock is with a good pair of bolt cutters. Usually the hasp is the weakest part so cut it instead of the lock. Some locksmiths use a "lock popper" as shown in fig. 4. Such a tool isn't hard to make.
4. Look for unlocked windows - burglars do. As a matter of fact most illegal entry is through an unlocked window.

5. If the bolt is exposed and isn't the "deadlocking" type it can be easily worked back into the door with nothing more than a knife blade. Just push or pull the door in the direction of opening thus putting a small amount of force on the bolt. Now insert your knife blade as close to the striker plate as possible. After cutting ever so slightly into the metal latch twist the knife toward the edge of the door, forcing the bolt back into the door. You may have to repeat this procedure several times depending on how far the latch extends into the striker plate.
6. Check the hinge pins. Many doors are installed with cheap hardware. The hinges on outward swinging doors will have easy to remove pins exposed to the outside. All you need here is a pair of good vice grip pliers.
7. Safety chain latches on doors can be undone with a tool shown in fig. 1.
8. Sliding arcadia doors are especially vulnerable to being lifted out of their track at the bottom with a tire tool or large screwdriver.
9. The latch of most key-in-knob door locks extends into the striker plate only about 1/8 in. These doors are easily opened by use of a jimmy bar, wire tool, or by using a small auto jack and a piece of 2x4. There is enough give in the door frames that you can force or jack them apart enough for the latch to clear the striker plate.
10. A lot of doors are constructed with 2 pieces of Masonite with random spaced blocks separating them. It's quite easy to cut, saw, or knock a hole in a door like this. Once done you can reach in and have access to the locking mechanism.
11. Window glass is especially vulnerable to being cut or broken. To cut a small opening in a window proceed as follows: Using a glass cutter or a carbide scribe tool scratch a groove around the perimeter of the opening you desire. Completely cover the opening area and beyond the scratch lines by about 2 in. with masking tape. Carefully tap the opening area and along the scratch lines. The glass will probably break into several small pieces all held together by the masking tape. Now carefully peel the tape and broken glass away exposing the opening. With some practice this can be done mostly with little noise. Get an old window frame and practice on it. After cutting the opening you may wish to cover the exposed edges with some more masking tape before reaching through.

12. Most night latch cylinders are attached to the lock mechanism by 2 screws. By wrenching the cylinder these screws are either bent or broken and the entire body of the cylinder is turned to actuate the mechanism or the cylinder is removed and the lock mechanism is actuated by a screwdriver inserted into the slot where the tail piece of the cylinder was. A large pair of water pump pliers work nicely in most cases. Most cylinders have a stamped sheet metal bezel which can be crushed with the pliers while grabbing the cylinder rim. Sometimes you will find that an attempt has been made to burglar proof a cylinder by replacing the sheet metal bezel with a harden steel one. Of course this will not crush and will also turn without the cylinder. A tool as described in fig. 2 can be employed in such cases.

Use the 2 holes as a drill jig to drill 2 - 3/16 dia holes into the face of the cylinder. Insert the pins in the other end of the tool into the holes in the cylinder and using the tool as a spanner wrench the cylinder can now be turned.

13. Drilling the pins of a cylinder lock is illustrated in fig. 3. Use a 1/8 in. high speed drill bit and drill through the pins at the shear line. After drilling through all the pins (most locks have 5) remove the drill and drive a flat screwdriver into the keyway and turn the cylinder. Sometimes a drilled pin will drop out and block the turning. If this happens just re-drill and try again.

We have now covered the more basic and most common ways of forcing entry. All are somewhat crude and make noise to some degree. If your objective is in an isolated area then noise may be of little or no concern. However, most objectives will be in an urban area and noise can be of vital importance. Here is three way to improve the situation somewhat.

1. Develop your techniques and skills. Confidence in yourself will allow you to proceed more surely and consequently more quietly.
2. Muffle sounds by various methods. When cutting something with wire cutters or bolt cutters wrap the object being cut with cloth (your handkerchief) or a piece of self sticking foam like weather stripping works nicely. If drilling with an electric drill wrap it with foam plastic like used for upholstery. The air coolant is not blocked but for short durations it won't get too hot. Wrap the foam with masking tape. This sure technique will be a tried to say noise emitting tool.

3. Create diversionary noise. An example could be as follows: An automobile has a simulated flat tire or other trouble. The clanging of tools, radio playing, people talking, etc. would create an excellent cover while an accomplice enters an adjacent building. In making diversionary noise don't do anything that would appear out of the ordinary and attract undue attention.

There are several obstacles that we have purposely omitted up till now. This was done so as to not confuse the actual entry method. These are important and must be considered. There is many but the most common are the following:

1. Dogs - both the noisy kind and the biting kind.
2. Guards
3. Alarm systems.

These all deserve special attention and we mention them here only to bring to light an important point and that is the importance of intelligence or if you will "scoping the joint" before hand. If at all possible know as much about your objective as possible. Use any excuse to observe as much of your objective as possible. Don't do any cursing or yelling, even go truck or treating with some bills to the front door of your objective house. You'll get a good look at the front door lock plus a piece of candy.

An old Air Force slogan comes to mind - WHAT YOU DON'T KNOW WON'T HURT YOU - - - IT WILL KILL YOU !

Practice some of the opening techniques (at least the non-destructive ones) on your own home. While visiting friends observe their doors, windows, and locks. For practice try to figure out the best and quickest way to enter it.

The purpose of this bulletin has been to present to every member of the SAC much hard information. Advanced training will be made available to those who have the skill and desire to advance into more sophisticated methods of entry.

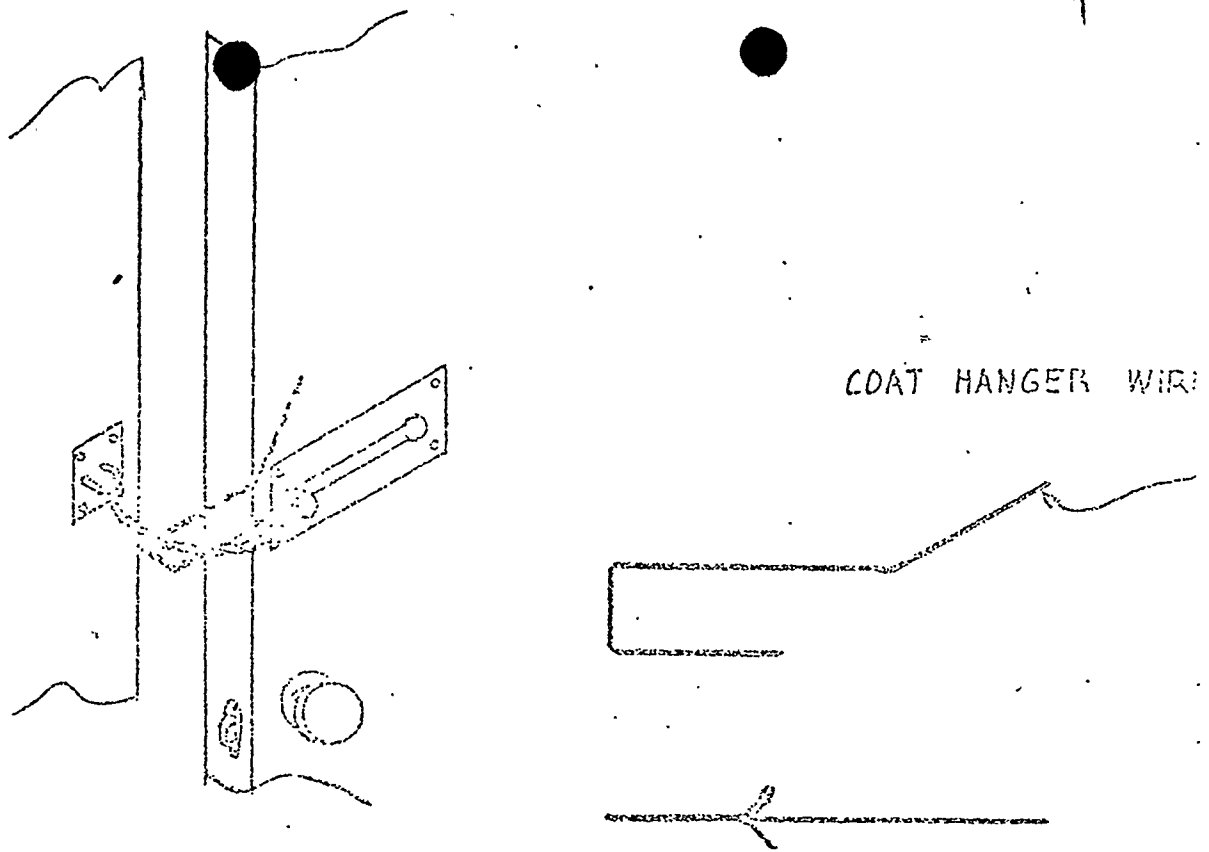

FIG. 1

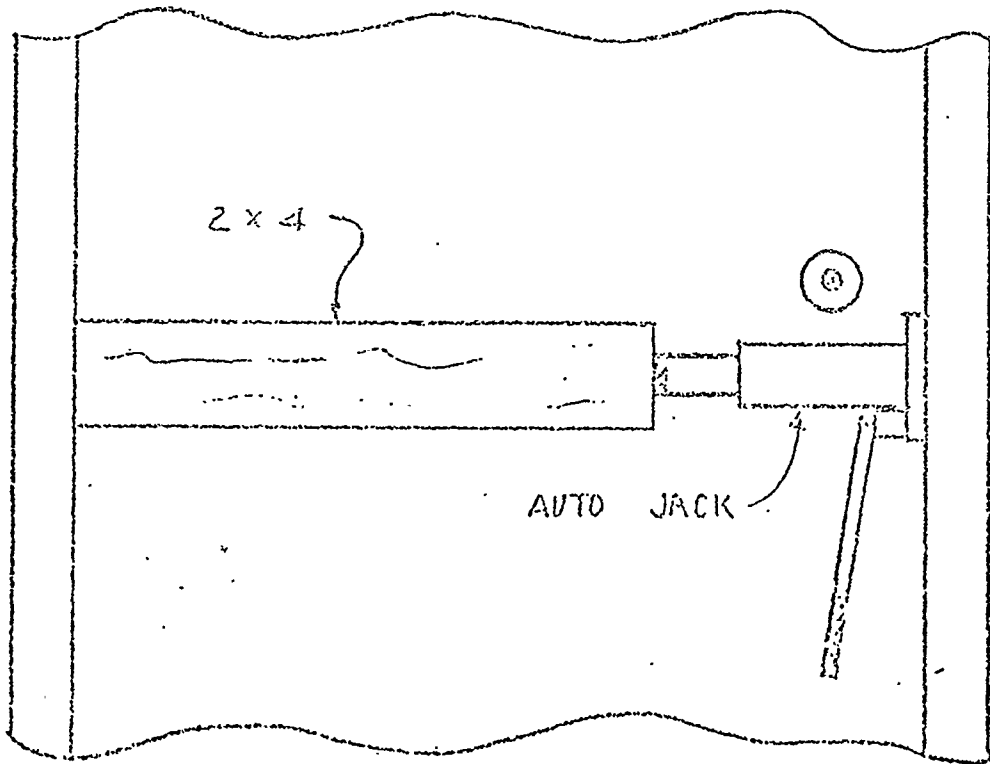

FIG. 2



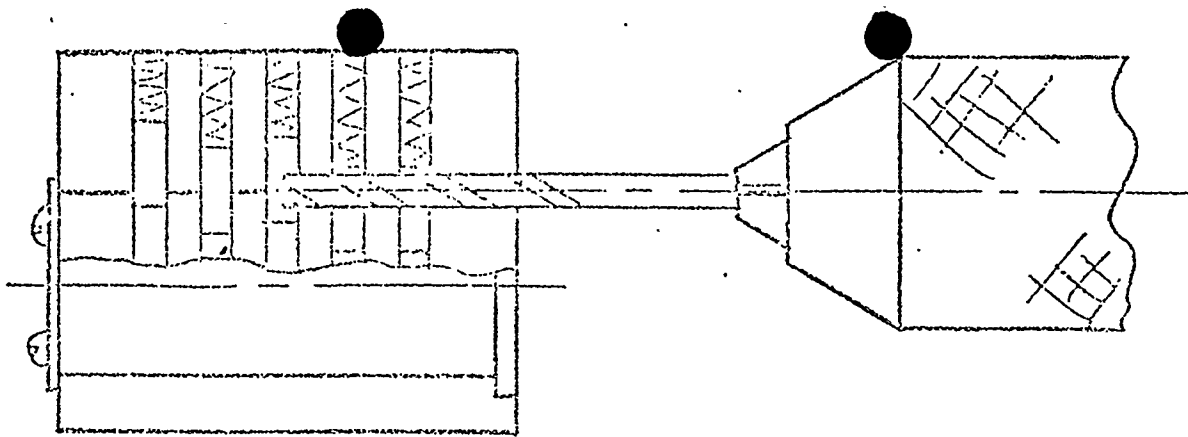

FIG 3

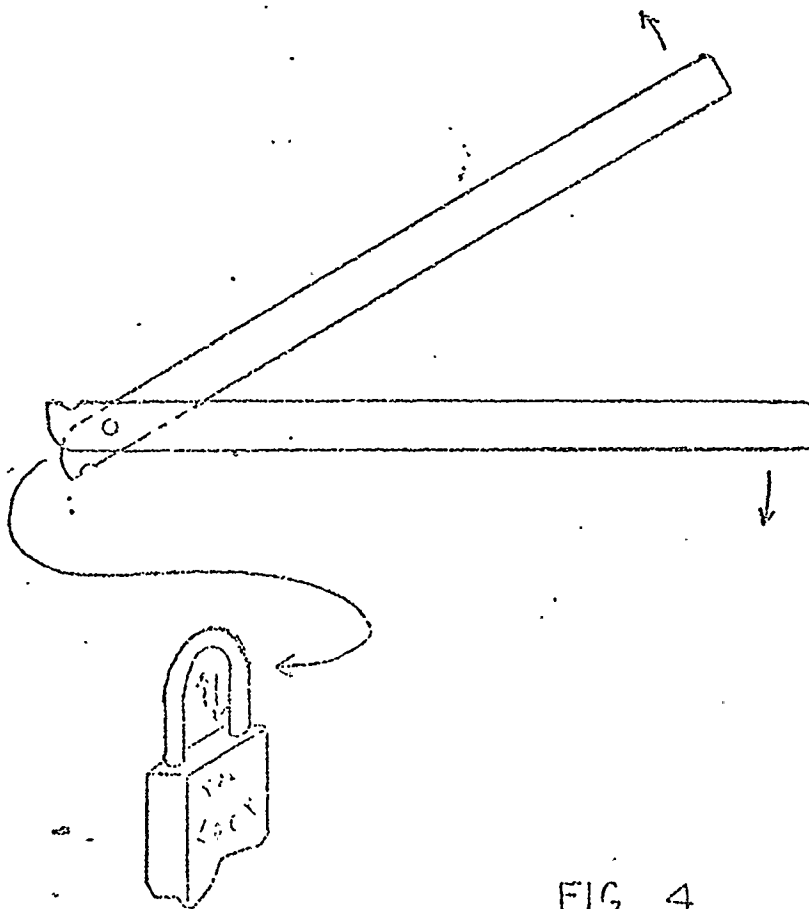

FIG 4

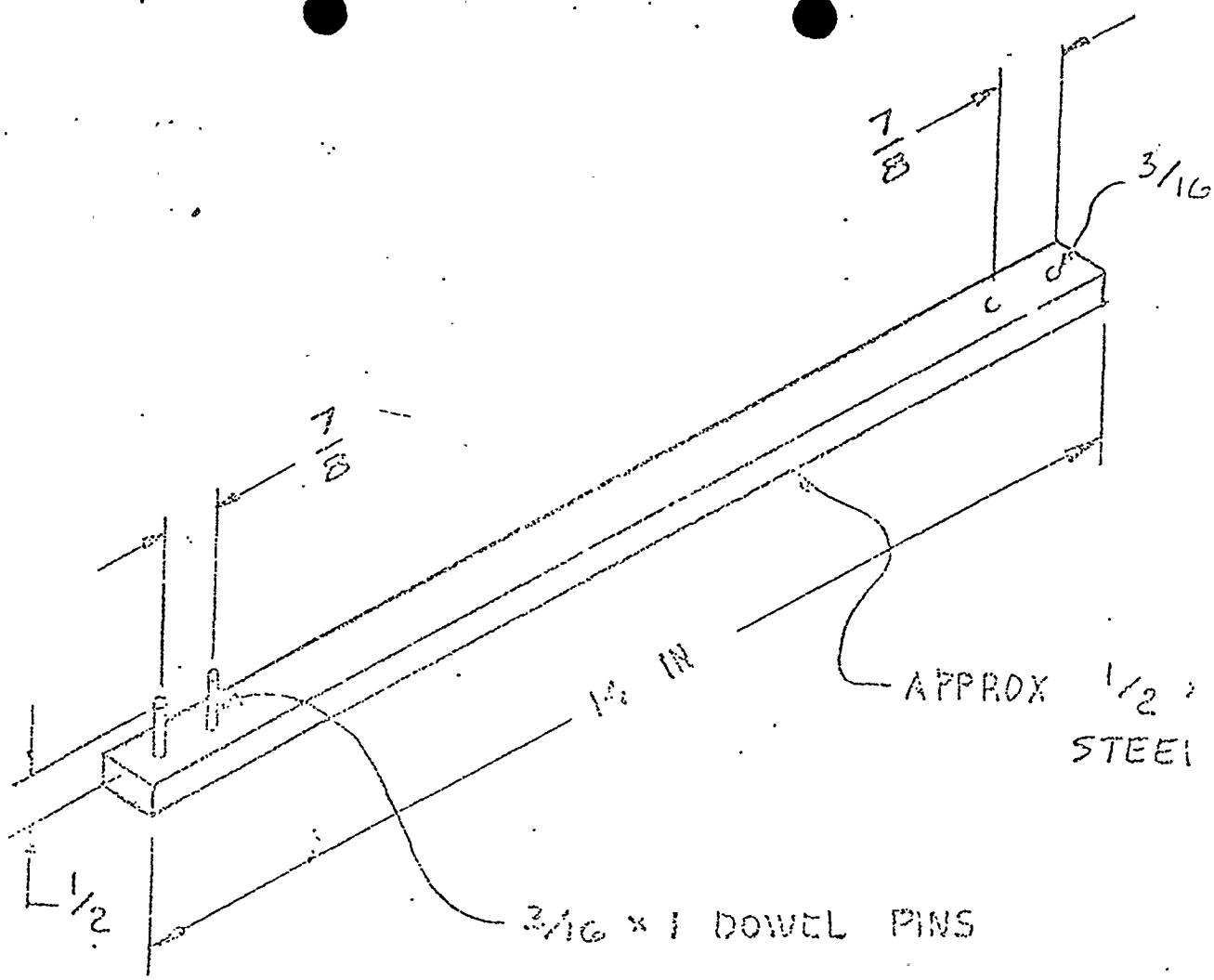
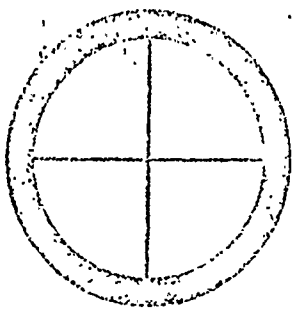

FIG 5



# SECRET ARMY ORGANIZATION

## UNDERGROUND BULLETIN

---

GENERAL HEADQUARTERS

MAY 1972

---

" Liberty has never come from the government. The history of Liberty is the history of the limitations of government power, not the increase of it. " Woodrow Wilson

Fellow members,

Every few days the American people are presented with renewed evidence of treason within our own country. Some of our national leaders have become so brazen that they now readily admit to things which a few years ago would have resulted in public indignation to the point of revolution. Good propaganda is not recognized as such and for forty years at least, the American people have been subtly brainwashed to the point that their apathy and indifference is a sickness.

In our organizational literature we have often stressed that the basic battle facing our country today is the one between individualism and collectivism. In its political form it appears as personal freedom versus police state regimentation. This war can only be won by personal initiative.

In times of emergency, our members are not going to be able to depend on General Headquarters for training material, bulletins and printed propaganda items. Local units and often the lone individual will have to improvise all these things. Communications to and from higher commands may be uncertain and the transmission of organization orders may be slow.

We must have people who think for themselves. Equally important, we must have people who can see what needs to be done and get at it without being told. In a combat emergency individual team and group leaders must be able to carry on the battle at the local level without direct support or contact with higher command.

Every unit should establish a pre-emergency command post which can be activated at short notice once fighting breaks out. The location of this command post should be kept secret from all unit members, except those needed to set it up. The site could be that of a garage, basement, rented building, etc. If the communists ever attempt a general roundup of SAO members the unit must have a secure site to retreat to, reorganize, and then, COUNTER-ATTACK.

There are many ways in which the individual member can help in the task of fighting fire with fire. Before the organization can even begin to issue counter-propaganda, or to infiltrate the enemy, it must first be known what the enemy is currently saying in his propaganda; what the current party line is; which are the communist fronts; which are the actual cells, etc. Ground work information is available to everyone through the simple process of keeping one's eyes and ears open, and this information is absolutely necessary before any kind of concrete and effective action can be initiated against the enemy.

The average member would be amazed at the amount of information about local reds and their activities which can be gleaned from the newspapers. Such clippings, when sent to a central office for further study and evaluation yield extensive information on individuals as well as organizations. Never underestimate a newspaper just because it is communist controlled --- the best source of information about the enemy is himself.

Then too, everyone can collect every piece of communist propaganda with which they come into contact. Some may even subscribe under another name to communist papers and publications, or join local communist fronts to acquire literature and names. All of this information when compiled in one place forms a clear picture of what the enemy's current plan of attack is as well as who the enemy is with names and addresses.

The type of information which we are most interested in is the identity, address, and other personal information concerning those American citizens that are openly promoting the communist line. Whether they are doing this intentionally or unintentionally will have to be determined by further investigation. Our first job is to simply identify these people by name, address, phone number, occupation and description. When you send in an intelligence card on some local pro-communist or "peace agitator" try to look this information up locally through your telephone book, city directory and similar sources. It will be much easier and faster for you to do this locally than for us to obtain such information by long distance.

We are repeating in this bulletin a diagram showing the proper placement of this information on a 3 x 5 index card. Use it as a guide when making out intelligence cards.

Smith, John D.

December 1, 1970

Home Address: 657 Riverside Drive  
Los Angeles, California 90000  
Telephone: 222-3333

Automobile: 1968 Ford, Green 4-Door, Lic. No. CAL 555

Activities: Gave a talk against war to the Santa Ana Chapter of the Peace and Freedom Party. Smith is a full Professor of Political Science at UCLA. (source: Los Angeles Times, page A-4, November 25, 1970)

XXXX

(member's ID number)

to the meeting site to cancel the meeting. Before going to the meeting site, each member must ascertain that there are no signals which cancel the meeting.

The question of leaving for a meeting must be thoroughly planned. It is particularly important that underground members know how to leave their homes quite naturally at both a reasonable and required time, how to explain their visits to certain public places, and how to make their "spot checks" along the route. The continuity and regularity of underground communications depend on such planning.

Depending on conditions, one should start for a meeting well ahead of time. One must check along the stipulated route to detect any surveillance by counter-intelligence personnel. If surveillance is detected, one must carry out his cover reason for leaving, then return to the point of departure to attempt to make another secure departure. At times a underground member may have to make several tries before he succeeds in his efforts in evading surveillance.

### Recommendations For The Conduct Of SAO Officers Engaged In Personal Communications

Conduct of a meeting is the basic phase of resistance operations. Meetings play an important role in the training of the individual resistance member. Therefore they should be conducted in a precise, well-planned manner, with a thorough knowledge of the case and paying attention to all circumstances. During the meeting the officer must not only describe the order of the meeting with the member and the cover story for the meeting, review the instructions for the alternate meeting, hear the member's report, and assign him tasks, but he must also instruct him in various matters, listen to his questions, and give him competent answers. The officer must take a constant interest in the member's personal affairs and situation so that the member can be cautioned in advance, if need be, about possible errors in his conduct.

Because meetings should not be too lengthy, the officer must be well prepared for each meeting. During the meeting he must be alert to catch the most fleeting changes in the member's mood. To a large extent, an officer's authority depends on his conduct, his discussion of operational matters, the ability to conceal the fatigue which he might be feeling after a long trip and many security checks. Nor should he show any nervousness, whatever the external reasons might be. If the officer exhibits stability and self-control, the member will acquire confidence in working with our organization.

The conduct of an officer bears directly on his work with members. The people with whom the officer comes in contact must be convinced that all his actions and his bearing are determined by his job, by the nature of his personal life, and by his cultural tastes. He must accustom those around him to a pattern of activities which naturally includes underground work. To overcome the obstacles of counter-intelligence, our officers must adopt special security measures. Secret Army Organization officers who are under semi-constant surveillance by counter-intelligence personnel are particularly compelled to make considerable use of special security measures.

If he is sure that he is not under surveillance, the officer uses this trip to the city to get a better knowledge of the city to choose meeting places, dead drops, and locations for posting signals, and to select and confirm routes along which checks can be made for surveillance. If he detects surveillance, the officer must act according to a previously conceived cover plan.

It would be helpful if an underground member could give the impression that he is fond of taking walks about the city. At the same time, he must try to learn the methods of surveillance, in order not to show his familiarity with the modus operandi of enemy counter-intelligence personnel. Similarly, an underground member who is under surveillance must not exhibit nervousness or do anything which is unnatural.

Every SAO officer who handles other members must have previously selected and well-learned routes which afford the most favorable opportunities for the detection of surveillance.

A check route may include travel by automobile (which can then be parked on a side street or in some city garage); the use of uncrowded streets, especially in those areas where parallel surveillance is impossible; travel by subway or bus with several transfers at quiet stations; visits to large stores and other buildings with numerous entrances and exits. At the same time that such routes are being selected, a good cover story should also be developed to explain the underground member's presence in a certain area.

When different members of a resistance movement meet each other for the first time, the identity of each should be confirmed by prearranged signs and countersigns. The best sign is a question, and the countersign, the answer to the question. Both sign and countersign have predetermined words or phrases. These predetermined words can be the names of people, movies, libraries, newspapers, magazines, etc. Both the question and the answer must be short and simple in content and in pronunciation.

In arranging for a recognition meeting and, above all, for the recognition signs and countersigns, the resistance officer has sufficient opportunity to exhibit his resourcefulness, initiative, and creativity, and to solve all problems with originality and with due consideration to local conditions.

### Communications Through Cut-Outs And Live Drops

In individual cases it becomes necessary to resort to cut-outs and live drops as a means of arranging communications. In each operation, the unit leader very carefully trains a cut-out: he instructs and trains him, instills in him the desired qualities, and monitors his fulfillment of tasks. Even when communications are through a cut-out, it is still necessary for the unit leader to meet periodically with the individual member to determine personally whether the work is going properly and whether the tasks are conveyed to the member. The unit leader must take an interest in the relations between the cut-out and the member in order to influence the entire course of the work.

If the member lives in another city, the cut-out must have the opportunity of visiting that city. The following people have this opportunity: service personnel of the various types of passenger and freight transportation; representatives and agents of trading and manufacturing firms, insurance companies, and real-estate offices; correspondents, etc.

The cut-out receives (from the members) only such information as is required for his work. As a rule, the names and addresses of the resistance officer and members are not given to the cut-out.

In communications via a live drop there is no personal contact between the member and the officer. Operational materials from the member to the case officer, and vice versa, are passed through a third person who more often than not is the proprietor of a small private business (book stores, gas stations, antique stores, drug stores, etc.)

The unit leader visits the live drop to receive materials only after a special signal is given. The proprietor of the live drop places the signal after receiving material from the member.

## 2. IMPERSONAL COMMUNICATIONS

Under the complex operating conditions that will confront any resistance movement in the United States, most communications will be by indirect methods. Experience has shown that this is the most secure type of communication, because there is no direct contact between members.

Impersonal communication is used to pass operational materials, to assign missions, and to pass material (technical supplies), to the unit leader and individual member.

The basic forms of impersonal communications are radio communications, dead drops, postal-telegraph systems, telephone, press, and communications via signals.

### Radio Communications

Ultrashortwave (UHF) radio sets may be used for communications under some conditions. These sets greatly improve the efficiency of underground communications. They have a small operating radius. Nevertheless, while on the air, accidental or intentional radio monitoring is possible; and the resistance movement cannot afford to ignore this consideration. The use of specially devised codes, ciphers, signal system, and operating schedule makes the use of this set completely secure. Radio communications can be used to call members together for an emergency meeting, to inform a member when a dead drop has been loaded or unloaded, to notify him about a change in dead drops, etc. UHF radio can also be used to assign missions to members and to receive intelligence information from them. Radio communications over UHF must be kept short.

To have communications via UHF, one must set up a schedule for radio contact. This schedule provides for a location for each radio station, the precise time to start sending (date, hour, and minute), which radio station will begin transmitting first, and all other details.

Dead drops may be extensively used for communications with an underground network. The use of dead drops in communications with members has several advantages over personal meetings. Some of these advantages are:

1. Dead drop communications are safer as there is no direct contact between officer and member.
2. They are more secure, because the member need not know the officer with whom he is in contact via the dead drop.
3. When necessary, it is possible to replace or substitute one officer with another.
4. There is the possibility of wide flexibility in time.

The use of dead drops, however, is not without drawbacks. The dead drop is an intermediate link between the officer and member, and materials placed in a dead drop are outside their control for a certain length of time. Therefore we must reduce to a minimum the length of time during which materials are located in a dead drop.

In practice, stationary, portable, and mobile dead drops are used. Stationary dead drops are selected or specially prepared in parks and squares, in trees, in the ground, in fences, in benches, in monuments, in public buildings, and beyond populated places such as forests, fields, seashores, riverbanks, etc.

In selecting and preparing a dead drop in a park, one must bear in mind that squirrels or other animals can destroy the dead drop (especially in hollow trees) or carry the message off. As a rule, a dead drop is used only one time, after which a different one is used. It is preferable to adopt a system consisting of a series of dead drops for each member. One should work out a schedule for using dead drops so that the member will know the dead drop to be used in January, the one to be used in February, etc. The schedule can be prepared for a half year or for a full year, depending on the number available.

The use of portable dead drops is more worthy of consideration because it is considerably easier to find places for them. We have no particular difficulty in finding places that contain many discarded objects (boxes, tubes, bottles, cans, match boxes, cigarette packs, papers, etc.). Often these objects lie about in plain sight for long periods of time without arousing any interest. Among such objects, which are of no use to anybody, and which can be found in yards, in parks, etc., an underground officer can leave a similar object with material for a member concealed in it at a preselected place to have it picked up later by the member.

American household articles, medicines, and many other items are packaged in all kinds of boxes, cans, tubes, cases, and made of cardboard, metal and plastic. Hence there is an extremely wide selection of packages which can be used as portable dead drops. Among the items which can be used as portable dead drops and which can be prepared in advance are pieces of wood, stone, brick, clay, cement, plastic, and others.



bus as it leaves one terminal and taken off by a member in another city as the bus comes into the terminal there.

In communications through a dead drop the member receives his assignments in written form. These member assignments must be encoded or enciphered. Also, the material itself must be in a form suitable for passing through a dead drop. Therefore we must train the underground member in the use of ciphers, codes, the preparation of soft emulsion film, microdot, and secret writing.

The types of signals and the places for posting them in connection with dead drop communications are the same as those which were discussed in the section on personal meetings. Here we need only to emphasize the particular importance and convenience of radio in exchanging signals.

Several hours before the operation (no later than two hours) the officer travels to the city. He uses the time available for a thorough check to determine whether or not he is under surveillance. At the same time, he checks a prearranged place to see if a danger signal has been posted. As a rule, the check for a danger signal is made in an area other than the area where the dead drop is located.

Having determined that he is not under surveillance and that there is no danger signal, the officer goes to the dead drop. In the immediate vicinity of the dead drop he must once more confirm that conditions are right; then, without losing any time, go to the dead drop, load (unload) it, and proceed on the prescribed course.

On his return trip the resistance officer can place his signal that the dead drop has been loaded (unloaded). These same rules hold true for individual members engaged in using dead drop communications.

### The Clandestine Use Of Postal, Telegraph And Telephone Systems

The postal and telegraph system are most valuable in the sending of concealed underground messages. Secret messages must in no way differ from an ordinary letter, either in superficial appearance or in their overt contents. When making clandestine use of the postal and telegraph system to send organizational messages, members of the resistance movement must make full use of ciphers, codes, secret writing, and other means of concealing the message being sent.

The most convenient telephones for an underground member to use are those located in large department stores, train or bus stations, drugstores and outside pay phones. By means of innocent sounding code words it is possible to use a underground member's phone even when it's taped. For example, one member could call another member at his home and ask for John Doe, a wrong number. The member would then leave home and go to a predetermined public telephone and wait for a call from the first member.

ions must be short and well planned. Special phases (designating an emergency meeting or something else) must always be within the context of the conversation.

Experience shows that individual members not infrequently forget the communications arrangements, resulting in a break of the work routine. It is, therefore, advisable to check periodically the member's knowledge of individual parts of the communications system, including code words and their meaning.

If the unit officer plans to use a telephone when organizing a communications network, he must give serious consideration to the use of cut-out telephones. As a rule, a cut-out telephone is called from a public telephone. Such conversations are in code and should correspond to the cut-out telephone owner's work so that they will not vary in the least from the owner's daily telephone conversations. Signals can be given over the telephone (by voice or by rings). In transmitting signals over the telephone, we must pay attention to the time set for the signal; the time of day, code phrases, and the number of rings should be changed frequently.

### The Use Of The Press As A Signaling System

The United States has about two thousand daily newspapers with a circulation of about fifty-seven million, and more than seven thousand magazines. Most give considerable space to advertisements and all kinds of announcements.

Many advertisements can be adapted quite easily to the transmittal of information. Among the code words which can be used are: the names or description of a lost article; a description of the circumstances; the place and time lost; the size of the reward offered for its return, etc.

In arranging communications involving the use of the press, it is necessary to specify the particular newspaper or magazine in which the coded intelligence information will appear, the approximate date of publication, and the form of the correspondence (advertisement or announcement).

### The Use Of Signals

As a rule, signaling plays an auxiliary role in organizing communications. When using dead drops and when holding personal meetings and recognition meetings, underground members use signaling a great deal.

Signals should be varied as much as possible. We must make sure that the signals are natural and do not attract the attention of an outsider. They must be sufficiently clear and precise to preclude any misinterpretation.

Members can exchange signals at a distance while in sight of each other. Various objects may be used for this (handkerchiefs, gloves, cigarettes, etc.) as well as certain colors of clothing and other means. For example, if a member on look-out duty removed his jacket, it could serve as a warning to others engaged in an assignment or raid.

infrared signals not visible to the eye, a pocket flashlight equipped with a special infrared light filter can be used. Infrared signals are received with binoculars (B-I-8), which have a special "phosphor" element for this purpose that changes the invisible infrared rays into visible ones.

Signals may be transmitted by an announcement in the local press or by postcard, letter, or telegraph. Lastly, sound signals can be sent by radio or telephone. Thus, signals can be subdivided into graphic, object, light, sound, and personal signals.

Graphic signals are prearranged marks in the form of geometric figures, letters, lines, ciphers, etc., written in pencil, chalk, or some other sharp object in a specific, prearranged place or way.

Object signals are various small objects put in a specific, prearranged place. The object itself may serve as a signal; as can its position; or the object and its position together may be a signal.

A thorough study of the specific features of the local conditions enables one to select the most natural signals. Signals can also be made by sending the underground member books, magazines, or merchandise from self-service stores (markets) where it is the practice to deliver these things to the home.

A large variety of signals allows great diversification in the use of signals and prevents patterns. Certain signals (graphic and object) are used with dead drops; others (light signals, and sound signals transmitted by phone or radio) are used to call a member for a meeting and to warn of danger. The third group (signals given by radio and signals given through the mails or press) is used for communicating with the commands HQ or with members living in another city.

Thus, the selection of signals and the methods for their transmission depends on the circumstances, the assignment, and the operational situation.

There are three principle types of direct communications that can be used between a unit leader and his various members: radio communications, courier communications, and communications through the use of the postal-telegraph system. A brief description of each type follows:

1. Radio Communications: Radio communications provide the most rapid means of transmitting orders and instructions from headquarters to unit leaders and for sending of reports from unit leaders.

Every unit should train a radio operator and get in advance the best long range radio equipment they can afford. At least two members of each unit should be trained in the use of this equipment. This should be done as soon as possible.

The area commands can use amateur radio stations to transmit instructions as general gossip between friendly operators. Such signals must be planned in advance and given to units involved.

Signals can also be given by specially constructed technical means. To transmit infrared signals not visible to the eye, a pocket flashlight equipped with a special infrared light filter can be used. Infrared signals are received with binoculars (B-I-S), which have a special "phosphorus" element for this purpose that changes the invisible infrared rays into visible ones.

Signals may be transmitted by an announcement in the local press or by postcard, letter, or telegraph. Lastly, sound signals can be sent by radio or telephone. Thus, signals can be subdivided into graphic, object, light, sound, and personal signals.

Graphic signals are prearranged marks in the form of geometric figures, letters, lines, ciphers, etc., written in pencil, chalk, or some other sharp object in a specific, prearranged place or way.

Object signals are various small objects put in a specific, prearranged place. The object itself may serve as a signal; as can its position; or the object and its position together may be a signal.

A thorough study of the specific features of the local conditions enables one to select the most natural signals. Signals can also be made by sending the underground member books, magazines, or merchandise from self-service stores (markets) where it is the practice to deliver these things to the home.

A large variety of signals allows great diversification in the use of signals and prevents patterns. Certain signals (graphic and object) are used with dead drops; others (light signals, and sound signals transmitted by phone or radio) are used to call a member for a meeting and to warn of danger. The third group (signals given by radio and signals given through the mails or press) is used for communicating with the commands HQ or with members living in another city.

Thus, the selection of signals and the methods for their transmission depends on the circumstances, the assignment, and the operational situation.

There are three principle types of direct communications that can be used between a unit leader and his various members: radio communications, courier communications, and communications through the use of the postal-telegraph system. A brief description of each type follows:

1. Radio Communications: Radio communications provide the most rapid means of transmitting orders and instructions from headquarters to unit leaders and for sending of reports from unit leaders.

Every unit should train a radio operator and get in advance the best long range radio equipment they can afford. At least two members of each unit should be trained in the use of this equipment. This should be done as soon as possible.

The area commands can use amateur radio stations to transmit instructions as general gossip between friendly operators. Such signals must be planned in advance and given to units involved.

The mail can be used as a way to deliver graphic and object signals. The following can denote signals: sending a certain letter; the color and size of the envelope or paper, the cost or number of stamps; the nature of the letter; the kind of salutation, signature, etc. The signal must look natural and not attract the attention of postal employees or censors. This is important because the letters containing signals go through the usual postal channels.

Americans are the most technically competent people in the world. The widespread knowledge of chemistry, electronics, and photography by ordinary citizens will be of great help resisting any dictatorship that may be imposed upon us. We have the means available to us to maintain efficient communications throughout the country under almost any imaginable conditions. Let's make sure that we also have the necessary energy and determination.

SPECIAL NOTICE: Those members who own short wave radio equipment or have a reliable friend who does, should write to their regular mail drop and request a copy of the organization's communications questionnaire. The information supplied by this questionnaire will allow the organization to make possible use of your equipment in our communications network.

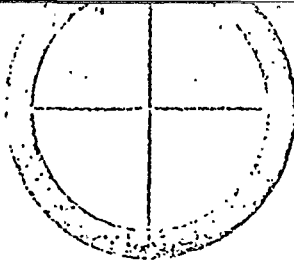

UNDERGROUND BULLETIN

GENERAL HEADQUARTERS

JUNE 1972

" The people never give up their liberties but under some delusion ". Edmund Burke

Fellow members,

At a recent meeting of the SAO General Staff a very important problem was discussed and the decision to issue a new Organizational Directive made. The problem is that of new members who join our organization and then immediately become totally inactive.

Typically these new members submit a well qualified application form together with their membership fee. Unfortunately, after being accepted as provisional members they never pay a month's dues or send in any report forms. It would really help us to know why some of these people have acted in this way. Did our organization turn out to be something different than they expected? Did they expect a fancy uniform and rifle to be handed to them on a silver platter? Or did they suddenly become afraid to stick their neck out?

Whatever the reasons, it isn't fair to our good members to waste time and money on those who do nothing to help or support the organization. Therefore, effective immediately, the following rules shall apply to such cases as mentioned above.

1. If, three months after submitting an application to the SAO and being accepted as a provisional member, the new member has not begun the basic correspondence training, submitted monthly report forms, paid monthly dues, or provided a reasonable excuse for not having done the above, their file shall be turned over to our Intelligence Section for special attention.
2. If, after six months, the member in question doesn't respond they shall be taken from our rolls and their names shall be circulated to all members as a potential security risk.

We don't mean to imply that a member can't resign from the Secret Army Organization. However, we do require that a member notify us of their intent and reasons for doing so. If this new Organizational Directive applies to any member in particular let him take notice and govern himself accordingly. GENERAL STAFF - SECRET ARMY ORGANIZATION

Although cosmoline can be purchased in many surplus stores, it may be more practical to make your own from the following directions. One advantage to making your own preparation is that it is much easier to apply while it is in a warm state.

Heat non-bleached petroleum jelly (amber-vaseline) in a small pan or can. Add 30 or 40 weight motor oil to obtain the proper consistency. Using an inexpensive throw-away paint brush as an applicator, brush the warm solution over the weapon. While the solution is still warm it can also be poured into those hard-to-get-at areas.

One large jar of petroleum jelly and approximately one-half quart of motor oil is sufficient to prepare several weapons.

When the solution has cooled it will set and form a protective coating over the weapon which should then be wrapped in sheet plastic (available in most hardware or paint stores) or in a G.I. plastic gun case (available in most surplus stores). Wrap well and seal with black electrical or plastic tape. It is also wise to enclose a small sack of silica gel crystals to keep the moisture out. These crystals can be purchased at any industrial chemical house or most appliance stores will give them away as they come with cartons of appliances when shipped and they usually have an abundance on supply.

Long guns which cannot be easily torn down can be stored in surplus rocket type boxes readily available in most surplus stores. Try to obtain aluminum or stainless steel containers since they will not tend to rust when buried. 20mm ammunition cans are adequate and a convenient size container for burying smaller weapons and other items. They should be well sealed. The cans should be wrapped in plastic to prevent rust.

Buried containers should have at least one and a half feet of earth over them. One should be careful also in selecting an area to bury material. Areas that could be flooded during even the most unusual weather conditions should be avoided.

Buried containers should be in such a position that they can be found easily and quickly without the use of maps. This can be done by correlation between two or more specific points that will remain in fact, such as trees, large rocks, etc. To assist your memory, paces should be marked off by using the day, month, and year of your birth or that of some family member which you can easily remember.

Another suggestion would be for burying containers along or near roads. The roads are marked with numbered signs indicating the footage of road per county. These are permanent, but it must be remembered that the state has a 100 foot right of way on most roads which means the brush may be cleared or the existing road might be widened.

All material which is buried should be checked within three to six weeks for rotting or shifting of the ground.

1. The first rule of guerrilla warfare is to dispense with any rule or set of rules which results in routine or predictable activity. Any time the enemy commander can anticipate what the guerrilla band will do next, he can then lay a trap by which his superiority of numbers and equipment may be brought to bear upon them with devastating effect.

2. Military action by guerrilla bands cannot achieve maximum effect unless intelligence and security capabilities are developed to an equal degree of perfection, principally through the cooperation of friendly non-combatants.

3. Propaganda warfare is one of the guerrillas most effective weapons. It must be waged continuously to demoralize the enemy, enlist support of the civilian population and to justify the existence and actions of the guerrilla bands.

4. Each member of the underground movement must be rendered immune to the enemy's propaganda by continuous counter-propaganda. They must realize that the enemy is certain to spread lies about their leaders, to try and break the bands up by encouraging petty jealousies and dissensions, to make them feel their fight is hopeless, to encourage them to get on the winning side, to offer mercy and rewards to those who voluntarily surrender. Most of all enemy propaganda will be aimed at destroying the individual organization member's faith in the honesty, capability and true motives of other members of the underground movement.

5. Surprise is the main element of successful guerrilla warfare. No matter how vigilant the enemy may be there will be times your band can take him by surprise. Perhaps he is tired, perhaps sleeping, perhaps he is in an area where he feels so completely safe that he lets down his guard-- that's when you hit him.

6. Any guerrilla that wants to keep on living must constantly remind himself that war is not a sporting proposition-- never give the communists an even break.

7. Generally speaking guerrillas must work in small bands. From five to fifteen is usual but even here its best not to get into a rut. If the enemy commander in your area knows you always work in small groups he can then divide his available anti-guerrilla forces into groups of 15 to 25 and thus cover more ground than if he had to maintain groups of two or three hundred to make certain his forces would always out number any guerrilla band they happened upon.

8. The guerrilla leader must always keep his thinking one step ahead of the enemy. Here are some examples:



highway when the driver sees something ahead. As they draw closer they see it is a man, apparently dead, sprawled in the middle of the highway. The car stops and the enemy officers get out to investigate. Suddenly the "corpse" rolls over and cuts them down with a machine gun.

This little trick might work several times but eventually the enemy will figure it out. The driver of a truck full of enemy troops sees a "corpse" lying in the road. Quickly he stops the truck. The troops pile out of the truck and riddle the "corpse" with bullets. Too late they discover its only a dummy made of old clothes and straw. They are caught in a murderous cross-fire between guerrillas hidden along both sides of the road. Most are killed but one lives long enough to tell what happened.

A few days later another truck of troops sees a "corpse" lying in the middle of the highway. The driver has been forewarned so he knows better than to stop. Instead he steps on the gas, runs over the dummy as he speeds on around the next curve in the road-- perhaps into a hidden land-mine. Or perhaps into a chain stretched between two trees. Or perhaps onto a part of the highway that has been covered with fresh oil which sends the truck skidding over an embankment.

What will the next truck full of troops do? What can you figure out so you will still be thinking one step ahead of the enemy?

9. Generally speaking the guerrilla band must avoid superior forces. When attacked by a superior force the guerrillas must quickly retreat or disperse. When the enemy stops, they may return to harass him-- or perhaps they won't. When the enemy is exhausted they may attack-- but again they may not. When the enemy retreats the guerrillas may give chase-- but only if they can be very sure they are not being led into a trap.

10. Guerrillas must always fight at a time and place of their own choosing-- never at a time or place of the enemy's choosing.

11. Before any raid on enemy troops or installations the guerrilla leader must obtain complete and accurate intelligence on the number of the enemy on hand, the number near enough to be called on for assistance, amount and type of enemy armament, location of sentries, scouts or protective patrols and all other information that will effect the planning or conduct of the raid.

12. All raids against the enemy must be exactly planned and carefully rehearsed. It is often desirable to draw a miniature copy of the enemy installation so that all members of the raiding party can play out their respective duties several times to make sure they do not forget or become confused in the heat of battle.

13. Everything that could possibly go wrong must be anticipated and alternate plans made to cope with any eventuality.

14. Guerrillas should strike a violent lightning blow that leaves the enemy stunned at least long enough for them to make a safe retreat.

15. In no case must the guerrillas allow themselves to be drawn into a long pitched battle with enemy troops.

16. So long as friendly forces of the conventional military are able to retain their offensive potential it is expedient for guerrilla forces to coordinate their activities with such friendly troops.

17. Guerrilla bands must always move in secret-- their whereabouts must always be hidden from the civilian population as well as from enemy troops.

18. When possible always attack the enemy at places which are distant from centers of population as this will reduce the possibility of his making reprisals against friendly civilians.

19. If a lone enemy soldier is way-laid in the city or suburbs it is best to carry his body away where it can be buried and the grave camouflaged so his commander will not know whether he has been killed or has deserted. Take his uniform and hide it carefully where it can be later retrieved. It might come in handy.

20. The guerrillas must always operate in their home territory where they have intimate knowledge of their surroundings. If driven from their own territory by a superior enemy force they should return as soon as they safely can, provided that their main hide-out has not been discovered and there is no chance of an enemy ambush.

21. Guerrillas must make every effort to stay friendly with any civilian population in their territory as the civilians may be their best source of food, other supplies, or valuable information about nearby enemy forces.

22. It is almost essential that the guerrilla band have at least one secure hide-out where they can rest up, store their supplies and care for their wounded. This hide-out may be in some large forest or mountainous area but such is not always necessary. During World War II one Russian guerrilla band had their headquarters in a storm sewer. Another band headquartered in the basement of a hospital in one of the smaller towns. Another operated from an abandoned coal mine.

23. The guerrilla band should have one or more alternate hide-outs and be ready to move quickly and quietly to another prepared location in case their main headquarters is discovered. To preserve maximum security the location of these alternate hide-outs should be known to the least possible number of their own band.

24. To operate successfully over long periods of time the guerrilla band must have plenty of space in which to maneuver-- preferably a large enough area that the enemy is incapable of covering all of it with anti-guerrilla forces at one time.

25. Guerrilla activity is most suitably conducted in mountains, swamp and other types of terrain that are inaccessible to tanks, large guns and organized forces but with proper strategy at least some guerrilla activity can be suited to almost any type area-- even large cities. Furthermore, due to the widespread use of light weight weapons such as the bazooka and recoilless rifle it must be expected that mountains will provide somewhat less protection to guerrillas in future wars than they have in the past. Therefore it is essential that underground activity be directed against the enemy under every possible condition and over the widest possible area so as to prevent his concentrating his forces for a complete "mop-up" operation in any one district.

26. Guerrilla forces cannot ordinarily afford to take prisoners. If you are lucky enough to capture a high-ranking officer or party official he may be held for ransom or as a hostage to guarantee against extreme brutality by the enemy or reprisals by the enemy against the civilian population. With extreme caution he may be traded for guerrillas held prisoner by the enemy.

Most commonly any captured enemy must be shot. If prisoners are taken they must be kept in chains and closely guarded day and night. If one were to escape he would certainly lead the enemy back to your hideout.

27. Due to their superior forces, the enemy may make several mistakes and still fight effectively. For the guerrilla band a single mistake may lead to complete annihilation. Therefore every activity must be conducted with extreme caution and complete secrecy.

28. Guerrillas must be extremely tidy housekeepers. Garbage thrown out around camp may attract birds which in turn may alert the enemy. A tin can, carelessly tossed aside may catch the sun just right to be seen by a scouting airplane. While on the march a broken branch or a thoughtlessly dropped match cover may give your presence away to the enemy who could radio ahead to set up an ambush.

29. Each member of the band must be constantly alert that his own action does not give away the guerrilla position to the enemy. In remote areas the smell of smoke may carry for many miles. Even cigarette smoke can give away the sentries position to a quietly approaching enemy scout. On a dark night the glow of a cigarette can be seen for 300 yards. With a good pair of binoculars it can be seen for a mile.

30. A single careless or obstinate member must not be allowed to endanger the lives of the other members of the band.

31. Guerrilla forces cannot afford defeat and are poorly equipped to care for casualties. Therefore, action against the enemy must be taken only under such conditions as insure maximum opportunity for success.

32. Before any action is taken against the enemy one or more other paths of retreat must be planned.

33. If a guerrilla is killed in action other members of the band should try to take his body with them as they retreat. It will become very demoralizing to the enemy if he is constantly aware of his own casualties but sees no evidence of guerrilla losses.

34. If a member of the guerrilla band is wounded then the other members must carry him away at all costs-- even at the risk of their own lives. This is essential both for the morale of the band but to make certain the fallen guerrilla is not tortured into revealing the identity of his friends and the location of their camp.

35. Guerrilla forces seldom attempt to occupy territory in the usual sense. Instead they seek to dominate the territory by continuous raids, ambushes and harassment of enemy troops to such an extent that continued occupation by enemy forces is no longer worth the price they must pay.

36. Success in guerrilla warfare depends largely on superior mobility.

Transport and movement are therefore of great importance to the guerrilla band. So long as the civilian population is allowed to use their automobiles the guerrillas can (with forged identity cards) do likewise. If the civilian population is rigidly controlled or largely enslaved then the guerrillas must depend on other methods of transportation.

Bands that must move on foot are limited in the distance over which they can operate. Possible targets for sabotage must be within two or three nights march. Even then the guerrillas are apt to be badly fatigued before they go into action and they will have trouble getting away without being discovered.

Suppose that a guerrilla scout reports that a poorly guarded supply column is camped 30 miles away. The guerrilla band may need these supplies desperately but if they must travel by foot the enemy will likely have moved on before they can get there. These are serious problems for which each band must find solutions depending on their own conditions and territory.

37. Close cooperation between different bands is seldom required and may be undesirable. Therefore it is more important that coordination between bands be secure than that it be fast.

38. Each guerrilla band is responsible for its own actions and bears the pain of its own mistakes without drawing other bands into any calamity that may befall it.

39. When anti-guerrilla activity becomes very intense, large bands should disperse into a number of small bands that can hide easier, move faster and slip their way through enemy lines with less risk of detection.

between sabotage and wanton destruction. All guerrilla activities must be conducted so as to cause minimal damage to private property.

41. Hit-or-miss sabotage is not nearly as effective as coordinated sabotage that strikes systematically at some few essential industries or activities vital to the enemy at that particular time.

42. Targets for raids and sabotage must be carefully selected to achieve maximum damage to the enemy with least risk to the guerrilla band. If the enemy has an abundance of guns but is low on ammunition then burning a warehouse full of guns will not count for much whereas burning a warehouse full of ammunition would be a vital blow.

43. Each military action against the enemy must be planned in such a manner that the amount of ammunition and supplies captured are at least enough to replenish the amount expended in that action.

44. Both offensive and defensive guerrilla activity is vitally dependent upon accurate knowledge of the enemy's strength, location, movements and so far as possible his intentions which is usually best obtained first hand by guerrilla scouts.

45. In the event that troops have settled down in the guerrilla area for a long and routine occupation, efforts should be made to determine whether or not they are completely loyal to the foreign ideology before antagonizing a possible potential ally.

46. The guerrilla must be continuously imagining himself in the shoes of his enemy. He must get to know how the enemy is likely to react in any given situation. He must be able to guess what the enemy commander will expect his band to do next. In this way he can often anticipate what the enemy will do. By then acting in some totally unexpected manner he can continuously catch the enemy in a series of embarrassing situations.

47. Guerrilla forces must remain widely dispersed throughout the entire area of enemy occupation. They must never accumulate in large numbers in a given area that the enemy can surround and eventually starve them out or gradually close in on them.

48. Guerrilla forces must be always alert to possible anti-guerrilla action that may be taken against them and constantly prepared to take suitable evasive action.

49. The guerrilla bands most essential function is to guarantee its own continuation. The very existence of the guerrilla band requires the enemy to guard against them and in so doing they are drained of manpower, supplies and equipment which the enemy forces might be needing badly in some other area.

50. Clear-cut victory is seldom possible either with or against guerrilla warfare-- the side that holds out longest will be the ultimate winner.

Please fill out and return to your assigned mail drop as quickly as possible. If you have not yet been assigned a regular mail drop, Mail to: P. O. Box 5791, San Diego, California 92105.

CODE NAME OR IDENTIFICATION NUMBER: \_\_\_\_\_

ADDRESS: \_\_\_\_\_ ZIP CODE: \_\_\_\_\_  
(Only if changed from last month)

BASIC CORRESPONDENCE TRAINING PROGRAM: (Enclose \$3.00 for each program)

Intelligence       Security       Propaganda       Recruiting

Special Note: Each program must be ordered only upon completion of the prior program. Enclose payment when ordering each program.

SECRET ARMY ORGANIZATION MATERIALS:

S. A. O. Stickers (50 for \$1.00)       S. A. O. Leaflets (50 for \$1.00)

Other Materials Needed: \_\_\_\_\_  
(Recruiting forms, Histories, Etc.)

S. A. O. DUES FOR \_\_\_\_\_ CONTRIBUTION TO S. A. O. \_\_\_\_\_

S. A. O. DUES FOR \_\_\_\_\_ MATERIALS \_\_\_\_\_

TOTAL ENCLOSED \_\_\_\_\_

DESCRIBE BRIEFLY YOUR ACTIVITIES PERTAINING TO THE ORGANIZATION DURING THE PAST MONTH:

### CHERRY BOMB

- 12 powders from cherry bombs
- 1 fuse from cherry bomb
- one snuff can 2" high and 1" across
- about 50 bees

After powder and bees are in can put lid on. Take ice pick, punch hole in top of lid. Slip fuse in. Then cover can completely with airplane glue around the base of the fuse to hold in place better when thrown.

### PLASTIC

- Potassium Chlorate
- Petroleum Jelly (Vaseline)
- A round wooden stick or rolling pin

Spread the Potassium Chlorate thinly on a hard surface. Roll the round stick (rolling pin) over the crystals to crush them into a very fine powder (until it looks like face powder). Take 9 parts of the powdered Potassium Chlorate and one part of vaseline, and knead them together until a uniform paste is obtained. Detonate with a blasting cap or with a .30 caliber fused blank.

### BLACK POWDER

- Potassium Nitrate - 25 parts
- Charcoal - 3 parts
- Sulphur - 2 parts

Dissolve the Potassium Nitrate in an equal amount of water. Pulverize the charcoal and sulphur, and add the Potassium Nitrate solution to obtain a thoroughly wet paste. Allow to dry.

### FAST BURNING FUSE

Twist soft cotton string into three strands. Moisten black powder to form a paste and rub the paste into the twisted string. Burns 30 to 40 inches per minute.

### SLOW BURNING FUSE

Dissolve one part of Potassium Nitrate or Potassium Chlorate and one part of sugar (granulated) in two parts of hot water. Soak the string in this solution. Twist the string into three strands and allow to dry. Burns about 2 inches per minute.

### FUSES

Fuses can be made by soaking coarse paper in a solution of gun powder and acetone (nail polish remover) overnight, then drying. Cut strips and twist together. Also, by coating a cotton string, with a sticky substance, then dipping into gunpowder, coating all surfaces. A time delay fuse that can be used without a match is made as follows: Make a small pile of potassium permanganate and make a small pile of it on the ground, making a hole in the center of it. Next pour in the hole about an equal amount of straight glycerine. A flash will occur in about one minute. This method is best used when gun powder has to be used as a fuse... or for starting fires.

### PACKAGE BOMB

- mouse trap
- electrical wire
- box or package

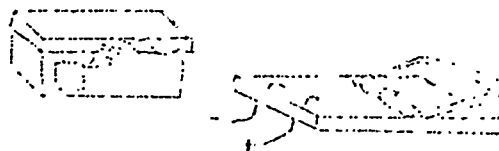

The mouse trap is the trigger. When the box is opened, the trap will close and contact on two electrical wires.

## JELLIED GASOLINE

Pour the contents of one bottle (1 pint 3 oz.) of Dynamo concentrated liquid laundry detergent into a bucket or large mouthed can of about two to five gallon size. Fill the detergent bottle twice, shaking well to rinse it out with gasoline (any grade) and add it to the detergent. You will now have about 3 1/2 pints (57 oz) of material in the bucket. The detergent will be at the bottom and the gasoline on the top. Stir this rapidly with a wooden or wire paddle so as to mix in as much air as possible. Soon the mixture will take on the appearance of soft vasoline.

Now add in a gallon of gasoline and stir again until the mixture thickens. At this point, transfer the mixture to clean containers. No return type beer and soda bottles are ideal. For chemical land mines, use two gallon oil cans. The container should be filled approximately one third full of the mixture. Finish filling the container with gasoline leaving a little air space at the top. Place your finger or hand over the opening and shake well until the gasoline and mixture amalgamate. You can verify this by locking off the finger or hand occasionally to see if a film of jellied gasoline about an eighth of an inch thick clings to it. When a proper consistency is reached, the bottles may be capped or corked. Cans should have tight fitting lids screwed on. This may be stored up to two weeks. Tie a rag around the neck of each bottle being careful not to leave the ends of the rag too long or too loose. If necessary, this mixture can be "cut" 50% with gasoline or other petroleum product. The tendency to "cling" will suffer slightly, but consistency can be maintained by pouring off the excess gasoline whenever the detergent refuses to "take" any more.

To use, saturate the rag with gasoline or the mixture from the bottle. Keep the flammable material off of your person and clothing. Light the rag with match or cigarette lighter and immediately serve. Throw end against a solid object such as masonry, concrete, or metal. In using the mixture in a chemical land mine, wrap three or four wraps of primacord around a two gallon can and tie the primacord under the can around a pound of explosive. This may be exploded either electrically or by a percussion such as a booby trap device or anti-personnel fuse. Do not contact wires to the blasting machine until after you have carefully removed all traces of your work and camouflaged the position. Never use any plastic article in contact with the above mixture.

## ARMOUR PIERCING BULLETS

Reloaders can drop a 25 caliber steel ball bearing into a .30 caliber bullet mould and thus have an armour piercing bullet. It is also a duplex bullet as the ball bearing will keep going after the lead has stopped.

## SHRAPNEL MINE

Length of stove pipe  
nuts, bolts, buck shot, etc.  
wood  
dynamite  
fuse

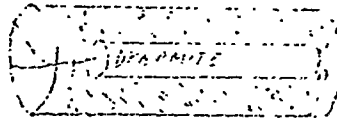

Block both ends of the stove pipe with wood after the stick of dynamite has been placed in the center, and the nuts, bolts, and other shrapnel material has been placed around the dynamite. Hang from a tree.

NOTES:



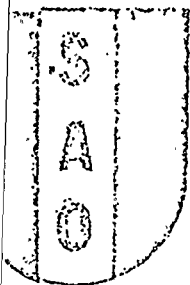

# SECRET ARMY ORGANIZATION

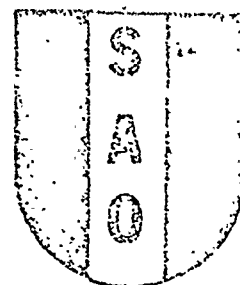

## GENERAL HEADQUARTERS

Dear Fellow American,

Your letter of inquiry concerning the Secret Army Organization was received a few days ago. We have had so many inquiries during the past few months that it has been impossible to answer each of them promptly with a personal letter.

We certainly appreciate your interest in our organization and we hope you will join us in our battle for national and individual freedom. As you learn more about the Secret Army Organization I'm sure you will come to realize that we are not radicals, but are far more inclined to be quietly dedicated and clear thinking individuals.

Enclosed is some further information about our organization, its history, objectives and programs. After you have given this material careful study, we hope you will use the enclosed application form to join our organization. When sending in your application, do not put your return address or name on the outside of the envelope.

After your membership application has been processed, we would certainly welcome having you work with one of our local units, or better still, help you organize your own unit with our assistance after you have completed preliminary training.

Sincerely yours,

Captain Patrick McDonald  
S. A. O. Headquarters Staff



# SECRET ARMY ORGANIZATION

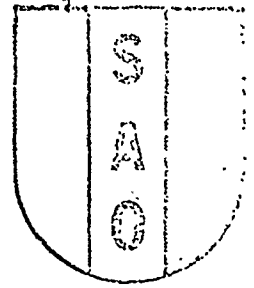

## GENERAL HEADQUARTERS

FROM: S. A. O. HEADQUARTERS

TO: FELLOW PATRIOTS

Greetings:

You may or may not have heard of the Secret Army Organization. In the past many patriotically oriented para-military groups have come and gone. Today the leadership of the S. A. O. is made up of those men who have weathered the storm of opposition and are more dedicated than ever to fighting the socialist parasites that are trying to enslave America.

If you care to join us we would welcome your application. However, we solicit your aid in any way that you can help. Your name has been coded so that you may contact us in a secure manner. Just use the coupon below or use the code number on it.

Sincerely yours,

Captain Jordan Wells  
S. A. O. Headquarters Staff

\*\*\*\*\*

Mail To: S. A. O.

P. O. Box 5791

San Diego, California 92105

Code Number \_\_\_\_\_

- Please send membership information and application form.
- I wish to contribute \$\_\_\_\_\_ to help with the fight.
- I will help distribute literature, posters, leaflets, etc.
- I wish to be removed from your mailing list.

# WANTED

for TREASON

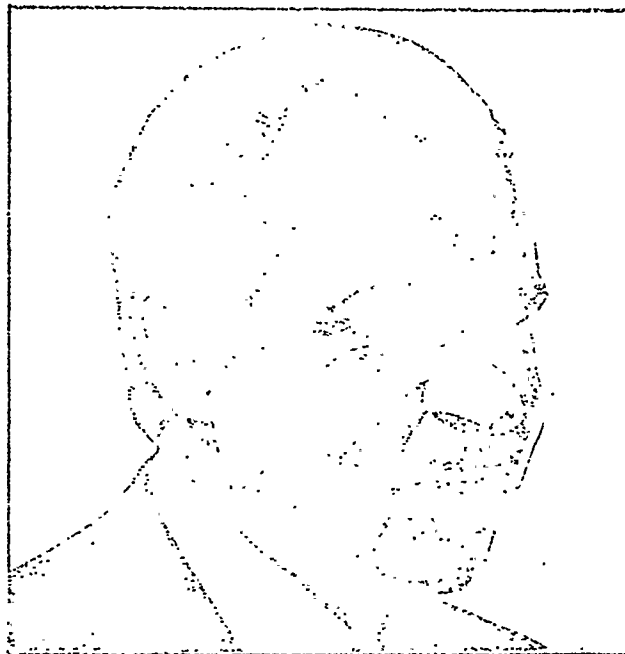

NIXON

Memorandum

TO : ACTING DIRECTOR, FBI (157-23577) DATE: 2/13/73

FROM : SAC, SAN DIEGO (157-2815) (P)

SUBJECT: SECRET ARMY ORGANIZATION  
EM

Re Bureau airtel to Sacramento, San Diego, and Los Angeles dated 1/5/73; San Diego airtel to Bureau dated 1/22/73.

Phoenix has advised by letter dated 2/8/73, that the alias, **INFORMANT** ; was used by **INFORMANT**

No further investigation being conducted in San Diego regarding **INFORMANT**

- ② Bureau (RM)
- 1- Sacramento (Info) (RM) (157-2195)
- 1- Los Angeles (Info) (RM)
- 1- Dallas (Info) (RM)
- 3- San Diego
  - (2-157-2815)
  - (1-157-3579)

EMP/ed  
(8)

ab

REC-54 157-23577-89

EX-103

FEB 15 1973



559  
7 FEB 27 1973

Buy U.S. Savings Bonds Regularly on the Payroll Savings Plan

EXT. DIV. RECD  
E.P. [Signature]

SAC, Baltimore

2/9/73

Acting Director, FBI (157-23577)

1 - Mr. E. R. Stark

SECRET ARMY ORGANIZATION  
BALTIMORE DIVISION  
EXTREMIST MATTERS

157-23577-88  
157-23577-88  
157-23577-88

Rerep of SA E. Bruce Gallagher 1/22/73 entitled  
"James Edward Ward, EM - Minutemen" (Baltimore file 157-6071)

Referenced report contains information from INFORMANT  
that "a new right wing organization known as the 'Secret Army  
Organization' has recently begun to operate in the Maryland  
area." Jesse Stephens, Harry Brockman, Victor Maness and James  
Ward were identified as Maryland residents known to be associated  
with the Secret Army Organization.

Initiate investigation of this group in your territory  
to determine activities and objectives and to identify leaders  
and members. Conduct active investigations of individual  
members and take aggressive steps to develop informant coverage  
of the organization. Past activities of this group in other  
areas make it essential that you remain alert during your  
investigations for violations of Federal Antiriot statutes and  
Federal gun laws.

Keep the Bureau and San Diego informed of significant  
developments.

1 - San Diego (157-2815)

MAILED 6  
FEB 13 1973  
REC-73  
FBI

157-23577-88

- Felt \_\_\_\_\_ 1 - 105-168537 (Jesse Stephens)
- Baker \_\_\_\_\_
- Callahan \_\_\_\_\_ 1 - 157-Harry Brockman
- Cleveland \_\_\_\_\_
- Conrad \_\_\_\_\_ 1 - 157-Victor Maness
- Gebhardt \_\_\_\_\_
- Jenkins \_\_\_\_\_ 1 - 157-21318 (James Ward)
- Marshall \_\_\_\_\_
- Miller, E.S. \_\_\_\_\_
- Murphy \_\_\_\_\_
- Nichols \_\_\_\_\_
- Rosen \_\_\_\_\_
- Sullivan \_\_\_\_\_
- Tavel \_\_\_\_\_
- Trotter \_\_\_\_\_
- Tele. Room \_\_\_\_\_
- Holmes \_\_\_\_\_
- Gandy \_\_\_\_\_

MCT-14

V220017

19 FEB 12 1973

SEE NOTE PAGE TWO

RECEIVED

57 FEB 20 1973

MAIL ROOM  TELETYPE UNIT

UNRECORDED COPY FILED IN

Letter to SAC, Baltimore  
RE: SECRET ARMY ORGANIZATION  
BALTIMORE DIVISION  
157-23577

NOTE:

The Secret Army Organization was formed in 1971 in Arizona by former members and supporters of the Minutemen. According to a source, the group intended to conduct intelligence type operations and offer training in urban guerrilla warfare to be used against left wing groups and suspected enemies of the United States. Members of this group have been arrested in the past on charges ranging from attempted murder to possession of explosives. Headquarters is in San Diego. We were not previously aware that the group existed in the Baltimore territory although prior information received indicated the Secret Army Organization in San Diego had established contact with former Minutemen in Maryland and had made tentative arrangements for an alliance with Minutemen in Maryland. Baltimore is in possession of background data on the Secret Army Organization. Investigative instructions issued are consistent with prior instructions relating to this group.

INMAY NO [unclear]

FEDERAL BUREAU OF INVESTIGATION  
COMMUNICATIONS SECTION

FBI  
JAN 28 1973  
1/27/73

- Mr. Baker \_\_\_\_\_
- Mr. Callahan \_\_\_\_\_
- Mr. Cleveland \_\_\_\_\_
- Mr. Conrad \_\_\_\_\_
- Mr. Dalbey \_\_\_\_\_
- Mr. Gethardt \_\_\_\_\_
- Mr. Jenkins \_\_\_\_\_
- Mr. Marshall \_\_\_\_\_
- Mr. Miller \_\_\_\_\_
- Mr. Purvis \_\_\_\_\_
- Mr. Soyars \_\_\_\_\_
- Mr. Walters \_\_\_\_\_
- Tele. Room \_\_\_\_\_
- Mr. Kinley \_\_\_\_\_
- Mr. Armstrong \_\_\_\_\_
- Ms. Herzig \_\_\_\_\_
- Mrs. Neenan \_\_\_\_\_

PLAINTIFF: WESTERN UNION  
TELEPHONE

Transmit the following in \_\_\_\_\_

TELETYPE \_\_\_\_\_  
NITEL \_\_\_\_\_  
(Priority)

ACTING DIRECTOR, FBI (157-22577)  
(Assignment: 120)

FROM: SAN DIEGO (157-2015)(P)

*Handwritten:* 6-11-73  
Lead on last page

RE: SECRECY ORGANIZATION (S.O.), SEPARATE MATTERS.

RE LETTER DATED JANUARY 19, 1973, TO REGINALD G. [unclear],  
SPECIAL AGENT IN CHARGE, FROM WINDYBORN L. [unclear], ATTORNEY AT LAW,  
440 OLIVE STREET, SAN DIEGO, CALIFORNIA.

ON JANUARY 6, 1972, TWO SHOTS WERE FIRED INTO THE [unclear]  
OF RADICAL PROFESSOR [unclear] [unclear] A GUEST IN THE  
[unclear]. THE SHOTS WERE FIRED BY GEORGE MITCHELL, MEMBER,  
[unclear] OF THE SECRECY ARMY ORGANIZATION (S.A.O.). HE WAS  
TRAVELING IN THE AUTOMOBILE OF THE INFORMANT HOWARD BARRY [unclear],  
WHEN THE SHOTS WERE FIRED, SUDDENLY WITHOUT PRIOR DISCUSSION  
[unclear].

REC-30 157 22577

20 FEB 12 1973

SECRETARY INFORMED THE [unclear] OF THE INDIVIDUAL [unclear]  
[unclear] THE SHOTS TO [unclear] [unclear] [unclear] L. [unclear]  
[unclear] THIS INFORMATION TO HIS SUPERIORS IN THE FBI AND  
[unclear] KENNETH G. [unclear] SAN DIEGO POLICE DEPARTMENT.

53 FEB 16 1973

1 - San Diego

WFR/ajs

*Handwritten:* See pg 12  
[unclear]

*Handwritten:* 5  
[unclear]

F B I

Date:

Transmit the following in \_\_\_\_\_  
(Type in plaintext or code)Via \_\_\_\_\_  
(Priority)

PAGE TWO

SD 157-2815

ON JULY 5, 1972, DURING A CONFERENCE WITH SAN DIEGO COUNTY DEPUTY DISTRICT ATTORNEYS RICHARD HUFFMAN AND JOHN KEFFNER, DETECTIVE RUBEN BRANSON, SAN DIEGO POLICE DEPARTMENT, AND HOWARD GODFREY IT WAS LEARNED THAT SPECIAL AGENT CHRISTENSEN MIGHT HAVE IN HIS POSSESSION THE 9 MM. PISTOL USED IN THE SHOOTING INTO BOLMER'S RESIDENCE.

CHRISTENSEN WAS TELEPHONICALLY CONTACTED IN LOS ANGELES WHILE EN ROUTE TO SAN DIEGO, RETURNING FROM HIS VACATION. HE STATED HE HAD THE GUN IN HIS POSSESSION AND RELATED WHERE THE GUN COULD BE LOCATED. THE GUN WAS TURNED OVER TO THE SAN DIEGO POLICE DEPARTMENT AS EVIDENCE ON THAT DATE.

GEORGE MITCHELL HOOVER WAS TRIED, CONVICTED AND SENTENCED TO A TERM OF FIVE YEARS TO LIFE IN PRISON. FORMER SPECIAL AGENT CHRISTENSEN TESTIFIED DURING THE TRIAL CONCERNING HIS RECEIPT OF THE GUN AND HIS SUBSEQUENT HANDLING OF IT. HE WAS SUBJECTED TO CROSS EXAMINATION BY THE DEFENSE.

THE SAO IS AN ANTI COMMUNIST, PARA MILITARY ORGANIZATION FOUNDED IN 1971 IN SAN DIEGO, CALIFORNIA. IT INTENDED TO COOR-



F B I

Date:

Transmit the following in \_\_\_\_\_  
(Type in plaintext or code)Via \_\_\_\_\_  
(Priority)

PAGE THREE

SD 157-2815

INTELLIGENCE TYPE OPERATIONS AGAINST "LEFT WING GROUPS"  
AND SUSPECTED ENEMIES OF THE UNITED STATES.

HOWARD BARRY GOSNEY, FOR A NUMBER OF YEARS, VOLUNTARILY  
FURNISHED THE FBI INFORMATION REGARDING THE IDENTITIES AND  
ACTIVITIES OF EXTREMIST GROUPS IN THE SAN DIEGO AREA. HIS  
INFORMATION HAS BEEN RELIABLE AND AS AN INTERESTED CITIZEN,  
HE VOLUNTEERED HIS KNOWLEDGE AND SERVICES TO LOCAL LAW  
ENFORCEMENT AGENCIES WHICH CULMINATED IN HIS APPEARANCE AND  
TESTIMONY BEFORE THE SAN DIEGO COUNTY GRAND JURY IN JUNE  
AND JULY, 1972.

ON JUNE 19, 1972, A BOMB EXPLODED IN THE GUILD THEATER,  
SAN DIEGO, CALIFORNIA. WILLY FRANCIS YAKOPEC TOLD GOSNEY  
GOSNEY, HIS NEXT DOOR NEIGHBOR, THAT HE HAD PLACED THE BOMB  
IN THE THEATER. HE UTILIZED FLAGS TO BOMB OTHER PLACES UN  
CONSIDERED TO BE PORNOGRAPHIC, INCLUDING GENIE'S MASSAGE  
PARLOR IN EL CAJON, CALIFORNIA. THIS INFORMATION WAS FUR-  
NISHED TO THE SAN DIEGO POLICE DEPARTMENT WHO INITIATED A  
SURVEILLANCE OF YAKOPEC IN AN EFFORT TO PREVENT FURTHER  
ACTS. YAKOPEC REACTED BY ATTEMPTING TO DRIVE HIS VEHICLE

F B I

Date:

Transmit the following in \_\_\_\_\_  
(Type in plaintext or code)Via \_\_\_\_\_  
(Priority)

PAGE FOUR

SD 157-2815

TWO VEHICLES BEING DRIVEN BY POLICE OFFICERS. THIS  
LATER RESULTED IN CHARGES OF ASSAULT ON SAN DIEGO POLICE  
OFFICERS. YAKOPEC WAS NOT AWARE THAT GODFREY WAS REPORTING  
REGULARLY TO THE FBI. HE INSISTED THAT GODFREY RIDE WITH  
HIM WHILE HE ATTEMPTED TO ELUDE THE SURVEILLANCE. GODFREY  
DID SO AND WAS IN YAKOPEC'S VEHICLE WHEN HE ATTEMPTED TO  
AVOID INVOLVED IN A HEAD ON COLLISION WITH ONE OF THE POLICE  
VEHICLES WITH BOTH VEHICLES TRAVELING AT HIGH SPEED.

YAKOPEC WAS TRIED AND CONVICTED FOR THE BOMBING OF THE  
THEATER AND FOR HIS ASSAULT ON POLICE OFFICERS. HE WAS  
SENTENCED TO A TERM OF ONE YEAR TO LIFE AND TO FOUR OTHER  
TERMS OF ONE TO FIVE YEARS. GODFREY HAD BEEN HELD IN  
CUSTODY BEFORE AND DURING THE TRIAL.

BEFORE THE TRIAL, SPECIAL AGENT EARL D.  
PETERSEN WAS SERVED A SUBPOENA BY LETTER FOR PRODUCTION OF  
"ALL RECORDS, NOTES, REPORTS AND OTHER MATERIAL REGARDING  
NORMAN DARRY GODFREY'S EMPLOYMENT AS AN FBI INFORMANT, IN-  
CLUDING BUT NOT LIMITED TO, HIS INITIAL APPLICATION AND

F B I

Date:

Transmit the following in \_\_\_\_\_  
(Type in plaintext or code)

Via \_\_\_\_\_  
(Priority)

PAGE FIVE

SD 157-2815

LETTER OF RESIGNATION."

AN AUSA MET WITH JUDGE, THE PROSECUTING ATTORNEY AND  
 DEFENSE ATTORNEY HETTER, AND IT WAS AGREED THAT THE FACT THAT  
 RECORDS WOULD NOT BE PRODUCED BY THE FEDERAL GOVERNMENT WOULD  
 NOT PREJUDICE OTHER TESTIMONY BY SA PETERSEN. SA PETERSEN'S  
 TESTIMONY WAS FIRST HEARD BY THE COURT WITH THE JURY PRESENT  
 AND THEN WAS REPEATED BEFORE THE JURY. QUESTIONS HAD PRE-  
 VIOUSLY BEEN SUBMITTED BY THE PROSECUTION AND APPROVED BY  
 THE JUSTICE DEPARTMENT. SA PETERSEN TESTIFIED UNDER CROSS  
 EXAMINATION BY HETTER. HETTER REPEATEDLY ASKED QUESTIONS  
 WHICH WERE OBJECTED TO BY THE PROSECUTION WITH THE OBJECTIONS  
 SUSTAINED BY THE JUDGE. AT ONE POINT HETTER WAS ADMONISHED  
 BY THE JUDGE FOR CONTINUING WITH A LINE OF QUESTIONING WHICH  
 THE JUDGE FELT WAS DESIGNED TO FORCE PRODUCTION OF GOVERNMENT  
 RECORDS CONCERNING THE SAC AND CONTACTS WITH GARRY COFFMAN.

YAKOPEC TESTIFIED IN HIS OWN DEFENSE AND FELLOW MEMBERS  
 OF THE SAC TESTIFIED FOR HIM. AT THE TIME YAKOPEC WAS  
 SENTENCED, NEWSPAPERS, RADIOS AND TELEVISION STATIONS IN SAK

FBI

Date:

Transmit the following in \_\_\_\_\_  
(Type in plaintext or code)

Via \_\_\_\_\_  
(Priority)

PAGE SIX

SD 157-2815

REPORTED THAT YAKOPEC TRULY ADMITTED TO THE COURT THAT HE HAD LIED IN HIS TESTIMONY. TWO OTHER INDIVIDUALS, ONE A MEMBER OF THE SAC, WERE TRIED AND CONVICTED ON PERJURY IN THEIR TESTIMONY IN DEFENSE OF YAKOPEC. AT THE TIME THE YAKOPEC CASE WENT TO THE JURY, NEWSPAPERS, IN SAN DIEGO REPORTED THAT YAKOPEC'S ATTORNEY, FREDERICK HETTER WAS GOING TO MOSCOW, RUSSIA TO ATTEND AN INTERNATIONAL LAWYERS CONFERENCE ON INTERNATIONAL LAW. HE RETURNED APPROXIMATELY TWO WEEKS LATER AND AT THAT TIME APPEARED IN SAN DIEGO COUNTY SUPERIOR COURT WEARING THE "RED STAR OF LENIN" ON HIS LAPEL. ACCORDING TO A SOURCE IN THE OFFICE OF THE SAN DIEGO COUNTY DISTRICT ATTORNEY.

ON JANUARY 15, 1973, THE TRIAL OF JERRY LYNN DAVIS WAS SCHEDULED TO BEGIN. HETTER HAD AGAIN DIRECTED A SUBPOENA TO SA PETERSEN FOR PRODUCTION OF RECORDS AND FOR TESTIMONY FOR THE DEFENSE. AUSA SHERIDON DEUTSCH, REPRESENTING THE FEDERAL GOVERNMENT IN THESE TRIALS, DIRECTED A LETTER TO HETTER POINTING OUT THAT IN ORDER FOR SA PETERSEN TO

F B I

Date:

Transmit the following in \_\_\_\_\_  
(Type in plaintext or code)Via \_\_\_\_\_  
(Priority)

PAGE SEVEN

CR 157-2015

TENTIFY FOR THE DEFENSE, IT WOULD BE NECESSARY TO PROVIDE A LIST OF QUESTIONS THAT HE WOULD BE ASKED IN ORDER THAT THESE QUESTIONS MIGHT BE SUBMITTED TO THE ATTORNEY GENERAL IN ADVANCE FOR APPROVAL. HE ALSO POINTED OUT THAT THE SUBSIDIA FOR PRODUCTION OF RECORDS WAS SO BROAD THAT COOPERATION BY THE FEDERAL GOVERNMENT WAS NOT POSSIBLE. AUSA BENESON RECEIVED NO REPLY TO THIS LETTER FROM MR. HETTER.

SA PETERSEN HAD ALSO BEEN SUBPOENAED BY THE PROSECUTOR TO ANSWER QUESTIONS WHICH WERE IDENTICAL TO THOSE WHICH HE ANSWERED BEFORE THE SAN DIEGO COUNTY GRAND JURY WHICH INDICTED DAVIS. THESE QUESTIONS AND ANSWERS WERE APPROVED BY THE OFFICE OF THE ATTORNEY GENERAL.

ON JANUARY 25, 1975, DAVIS ENTERED A PLEA OF GUILTY TO A LESSOR CHARGE. NEWSPAPERS, RADIOS AND TELEVISION STATION BROADCASTS REPORTED THE GUILTY PLEA AND QUOTED HETTER AS STATING THAT DAVIS INTENDED TO COOPERATE FULLY WITH THE LAW ENFORCEMENT AGENCIES.

FBI

Date:

Transmit the following in \_\_\_\_\_

(Type in plaintext or code)

Via \_\_\_\_\_

(Priority)

\* SD 157-2815

PAGE EIGHT

ON JANUARY 16, 1973, SPECIAL AGENTS DWIGHT G. GARRETTSON AND EARL M. PETERSEN WENT TO THE HOME OF DAVIS AND ADVISED HIM THAT THEY DESIRED TO SPEAK TO HIM CONCERNING THE ACTIVITIES OF THE SAC. DAVIS STATED THAT HE HAD AN ATTORNEY, FREDERICK FORTER AND THAT HE WOULD OBTAIN HIS CONSENT TO AN INTERVIEW WITH AGENTS OF THE FBI. DAVIS CONTINUED TO TALK TO GARRETTSON AND PETERSEN ABOUT THE SAC AND ABOUT HOWARD GODFREY. OTHER MEMBERS OF DAVIS' FAMILY RETURNED HOME, AT WHICH TIME SAs GARRETTSON AND PETERSEN WERE INVITED INTO THE HOUSE AND DAVIS AND HIS MOTHER CONTINUED TO TALK ABOUT ACTIVITIES OF THE SAC AND GODFREY. SA PETERSEN ASKED DAVIS FOR THE IDENTIFY OF THE LIEUTENANT COLONEL GERRIT L. HILLIARD, AND THIS WAS BY DAVIS THAT THIS WAS AN ALIAS USED BY AN SAC MEMBER IN ARIZONA. DAVIS STATED HE WOULD CONTACT THIS INDIVIDUAL AND OBTAIN AUTHORITY TO REVEAL HIS IDENTITY TO THE FBI. DAVIS AND HIS FAMILY WERE ANTAGONISTIC CONCERNING HARRY GODFREY, BUT WERE COMPLETELY FRIENDLY TO SAs GARRETTSON AND PETERSEN.

F B I

Date:

Transmit the following in \_\_\_\_\_

(Type in plaintext or code)

Via \_\_\_\_\_

(Priority)

\*PAGE NINE

SD 157-2015

ON JANUARY 17, 1973, INVESTIGATOR LAWRENCE WILSON, SAN DIEGO COUNTY DISTRICT ATTORNEY'S OFFICE, SAN DIEGO, ADVISED SA PETERSEN THAT DEPUTY DISTRICT ATTORNEY REGINA HUFFMAN DESIRED THAT DAVIS NOT BE INTERVIEWED BY LAW ENFORCEMENT UNTIL AFTER SENTENCING AS HETTER WAS ATTEMPTING TO GET A LIGHTER SENTENCE FOR DAVIS BY REPORTING HIS COMPLETE COOPERATION WITH LAW ENFORCEMENT. AT THAT TIME WILSON WAS ADVISED BY SA PETERSEN THAT ATTORNEY HETTER HAD MADE AN ARRANGEMENT WITH DETECTIVE RUBEN BRANDON, SAN DIEGO POLICE DEPARTMENT, FOR AN INTERVIEW AT 11:00 A.M., ON THAT DATE, DURING WHICH DAVIS WAS TO REVEAL CONSIDERABLE INFORMATION REGARDING THE SAO, INCLUDING A LIST OF LEFT WINGERS THAT THE SAO HAD PLANNED TO TAKE ACTION AGAINST. LATER THAT SAME DATE, DETECTIVE BRANDON ADVISED THAT HE HAD BEEN CONTACTED BY DEPUTY DISTRICT ATTORNEY HUFFMAN WHO HAD REQUESTED HE CANCEL HIS INTERVIEW WITH DAVIS, WHICH HE DID.

IN ACCORDANCE WITH THE DESIRES OF DEPUTY DISTRICT ATTORNEY HUFFMAN, NO FURTHER INTERVIEWS WITH DAVIS WILL BE CONDUCTED UNTIL AFTER HE IS SENTENCED ON FEBRUARY 26, 1973.

FBI

Date:

Transmit the following in \_\_\_\_\_  
(Type in plaintext or code)Via \_\_\_\_\_  
(Priority)

PAGE TEN

LA 157-2813

SAS GARRETSON AND PETERSEN DROVE TO THE DAVIS HOME IN AN UNMARKED AUTOMOBILE, PARKED DIRECTLY IN FRONT OF HIS HOUSE AND WALKED TO HIS FRONT DOOR AND RANG THE DOOR BELL. HANKS IS WELL ACQUAINTED WITH SA HENDERSON AND IT WAS NOT NECESSARY TO SHOW HIM FBI CREDENTIALS AT THE DOOR AND THERE IS NOTHING ABOUT THIS VISIT THAT WOULD INDICATE TO ANYONE THAT GARRETSON AND PETERSEN WERE SPECIAL AGENTS OF THE FBI.

ADMINISTRATIVE

INVESTIGATOR LAWRENCE WILSON, SAN DIEGO COUNTY DISTRICT ATTORNEY'S OFFICE, FORMERLY A CLERK IN THE LOS ANGELES OFFICE OF THE FBI, REPORTED THAT HETTER WORE THE RED STAR OF LENIN ON HIS LABEL WHEN HE RETURNED FROM MOSCOW.

WILSON ADVISED SA PETERSEN DISCOVERED THAT HETTER HAD TOLD HIM THAT HE WAS ATTENDING A SCHOOL IN CUBA DURING THE CUBAN REVOLUTION AND THAT HE AND HIS GIRLFRIEND HAD SOMETHING TO DO WITH AN UNIDENTIFIED GROUP INVOLVED IN THE REVOLUTION.



FBI

Date:

Transmit the following in \_\_\_\_\_  
(Type in plaintext or code)Via \_\_\_\_\_  
(Priority)

JAMES HENRY

SD 157-2815

WILSON STATED THAT HE HAS POINTED OUT TO HETTER ON NUMEROUS OCCASIONS DURING THE WASHINGTON TRIAL THAT A CONSPIRACY TO OBTAIN PERJURY WAS A VIOLATION OF THE LAW. WILSON HAD NO SPECIFIC INFORMATION THAT HETTER WAS INVOLVED IN SUCH A CONSPIRACY.

SAN DIEGO INDICES CONTAINED A NEWS MEMORY DATED GEORGE H. RO, 1970, REFLECTING THAT FREDERICK HETTER LEAD A BOARD MEMBERSHIP OF THE GAY LIBERATION FRONT (GLF), AND THE "DAUGHTERS OF ELLIUS" (DOB), ON THE CAMPUS OF SAN DIEGO STATE COLLEGE ON OCTOBER 13, 1970, WHEREIN HE ANSWERED QUESTIONS CONCERNING SOCIAL RIGHTS AND THE STATUS IN THE ARMED FORCES OF HOMOSEXUALS. HETTER PASSED OUT HIS CARD AND SOLICITED ANYONE HE FELT WOULD BENEFIT BY RETAINING HIS SERVICES. FILES OF HISS IDENTIFIED THE DOB AS A LESBIAN GROUP AND THE GLF AS A HOMOSEXUAL ORGANIZATION.

FBI

Date:

Transmit the following in \_\_\_\_\_  
(Type in plaintext or code)

Via \_\_\_\_\_  
(Priority)

SD 157-2815

PAGE TWELVE

BUREAU AUTHORITY IS REQUESTED TO FURNISH A COPY OF THE ABOVE LETTER BY REGISTER TO SENATE DISTRICT ATTORNEY RICHARD HOFFMAN, SAN DIEGO COUNTY DISTRICT ATTORNEY'S OFFICE, FOR HIS INFORMATION, INASMUCH AS THE LETTER REFLECTS MATTERS WHICH WILL POSSIBLY BE USED BY REGISTER IN CONTACTS WITH THE SAN DIEGO COUNTY SUPERIOR COURT IN CONNECTION WITH THE SENTENCING OF DAVIS.

*In line w/above, letter from Attorney General L. B. Nichols to Attorney General dated 1/23/73 was furnished to Gary Johnson, Investigation Section, OSD, USSJ per his request for handling this copy. Released for Bureau. 2/1/73*

CC MR. TRAINOR  
712-A 2&D

Approved: \_\_\_\_\_ Sent \_\_\_\_\_ M Per \_\_\_\_\_

F B I

Date: 1/22/73

Transmit the following in \_\_\_\_\_  
(Type in plaintext or code)

AIRTEL \_\_\_\_\_  
(Priority)

TO: ACTING DIRECTOR, FBI (157-23577)  
ATTN: DID

FROM: SAC, SAN DIEGO (157-2815) (P)

SECRET ARMY ORGANIZATION (SAO)  
EXTREMIST MATTERS

Re Sacramento airtel captioned "FRANCIS EARL GILLINGS, Alleged Plot to Kill the President - Conspiracy," and San Diego airtel to Dallas 1/16/73, captioned, **INFORMANT** EM - SAO."

For the information of Dallas, referenced Sacramento airtel contains a copy of a letter by **INFORMANT**.

For the information of the Bureau and other offices, referenced San Diego letter requested Dallas to obtain a copy of the letter signed **INFORMANT** in order that handwriting examinations could be made.

- ④ - Bureau
  - (2 - 175- ) (FRANCIS EARL GILLINGS)
  - (1 - 157-23577)
  - (1 - 157-21670)
- 2 - Albuquerque
- 2 - Chicago
- 2 - Dallas
- 2 - Detroit
- 2 - Kansas City
- 2 - Los Angeles
- 4 - San Diego
  - (2 - 157-2815)
  - (1 - 157-3579)
  - (1 - 157-3001)
- 2 - Mobile
- 2 - Phoenix
- 2 - Portland
- 2 - San Francisco
- 2 - Sacramento

EMP:bw  
(30)

57 FEB 0 1973

Unrecorded Copy Filed In

REC-33 157-23577-1  
25 JAN 25 1973  
[Handwritten signatures and stamps]

Approved: \_\_\_\_\_ Sent \_\_\_\_\_ M Per \_\_\_\_\_

Special Agent in Charge

On 1/16/73, JERRY LYNN DAVIS, SAO leader who entered a plea of guilty to possession of explosive material in connection with SAO activity, was interviewed. At that time, he advised that there has never been an SAO chapter in Sacramento, California, and that he has never heard of FRANCIS EARL GILLINGS. He said it is not surprising to him that the SAO is being credited with various plots, such as a threat against the President and Vice President but that to his knowledge, no such plot has ever been planned by the SAO. He advised that the arrests and prosecutions in San Diego have completely killed the SAO with the possible exception of a small group in Los Angeles who might still be operating independently under the Los Angeles leader, who DAVIS would not name.

DAVIS stated that the name **INFORMANT** is a one-time alias used by one of the SAO leaders in Arizona. He did not name this individual. He advised that the statement that the SAO members are being requested to join the John Birch Society is a joke to get the John Birchers riled up because of previous disagreements within this group. He feels that this letter will make the John Birch Society paranoid about taking in any new members as they would certainly not want SAO members in their group.

LEADS

PHOENIX

AT PHOENIX, ARIZONA. Will contact SAO sources to determine identity of **INFORMANT**

DALLAS

AT DALLAS, TEXAS. Discontinue attempts to obtain copy of letter by **INFORMANT** as **IDENTIFIES INFORMANT**

FBI

Date: 1/18/73

Transmit the following in \_\_\_\_\_  
(Type in plaintext or code)

Via AIRTEL AIRMAIL  
(Priority)

TO: ACTING DIRECTOR, FBI  
FROM: SAC, MOBILE (157-5095) (RUC)  
RE: FRANCIS EARL GILLINGS  
ALLEGED PLOT TO KILL THE  
PRESIDENT - CONSPIRACY  
(OO: SACRAMENTO)

Re Sacramento airtel to the Bureau and other offices including Mobile and Los Angeles, dated 12/13/72, captioned as above.

Mobile has had no organizational activity of the Tax Rebellion Committee (TRC) or the Secret Army Organization (SAO).

The letterhead of the TRC lists advisors to the TRC, Fresno, Calif., and included on this list is CHURCH E. MURDOCK, JR., Mobile, Ala.

MURDOCK is Dr. CHURCH ELWOOD MURDOCK, JR., a practicing physician at 1710 Center St., Mobile, Ala., residence 4455 Emperor Drive, Mobile. He is subject of an EM investigation, Mobile file 157-4515, Bureau file 157-24287. He is an associate of WILLIAM POTTER GALE, subject of investigation by the Los Angeles Office, Los Angeles file 157-571, Bureau file 62-105253. GALE is apparently the person referred to on Page 3 of referenced Sacramento airtel as Reverend GAIL.

- 3 - Bureau (1 - 175-FRANCIS EARL GILLINGS)  
(1 - 157-23577) 157-  
(1 - 157-21670)
- 3 - Sacramento (175-55)
- 2 - Los Angeles
- 3 - Mobile (1 - 157-5095)  
(1 - 157-444)  
(1 - 157-4515)

157-73577-  
NOT RECORDED  
JAN 21 1973

JTB:vwn  
(11)

55 FEB 5 1973

Approved: \_\_\_\_\_ Sent \_\_\_\_\_ M Per \_\_\_\_\_

Special Agent in Charge

U.S. Government Printing Office: 1972 - 488-524

Investigation by the Mobile Office during the past year has reflected that MURDOCK is the leader of the group referred to as the "Identity Group". He refers to himself as Reverend MURDOCK and the organization Ministry of Christ's Church. The group meets each Wednesday night at MURDOCK's residence.

WILLIAM POTTER GALE is also referred to as Colonel GALE and Reverend GALE, leader of the Ministry of Christ's Church, Post Office Box 423, Glendale, California. "Identity" is a quarterly publication of the Ministry of Christ's Church. At weekly meetings at the MURDOCK residence, tapes of sermons by GALE are played. A Mobile informant attending these meetings has not reported any indication of threats being made to kill the President or Vice-President, but discussions have been had concerning "Posse Comitatus". Members of the U. S. Christian Posse Association, organized under the auspices of the Ministry of Christ's Church, are stated by this group to be able to make arrests and trial by citizens' jury in event local Sheriff fails to perform a lawful duty.

MURDOCK and other members of his group at Mobile have likewise refused to pay Federal income taxes and reportedly have urged others to refuse to pay income taxes.

Investigation of MURDOCK and the "Identity Group" at Mobile is continuing, and any pertinent information developed will be reported to the Bureau and interested offices.

IN VIEW OF GILLINGS' STATEMENTS, HE SHOULD BE CONSIDERED ARMED AND DANGEROUS.

Domestic Intelligence Division

INFORMATIVE NOTE

Date 1/16/73

On 1/15/73 Jerry Lynn Davis, a leader of the Southern California based extremist Secret Army Organization (SAO), entered a plea of guilty in San Diego County Superior Court to a charge of possession of explosive materials. Sentencing is set for 2/26/73.

This is the sixth conviction of an SAO leader or member within the past four months resulting from information furnished by a former FBI informant.

Copy furnished Internal Security Division of the Justice Department.

RPF:was

*[Handwritten initials and signature]*  
GCM

*[Handwritten signature]*  
1-16  
2:29P

*[Handwritten initials]*  
EM/DEAN  
WBL

*[Handwritten initials]*  
MCK

*[Handwritten number]*  
85

JAN 16 1973

Mr. Callahan	_____
Mr. Cleveland	_____
Mr. Conrad	_____
Mr. Dalbey	_____
Mr. Gebhardt	_____
Mr. Jenkins	_____
Mr. Marshall	_____
Mr. Miller	_____
Mr. Purvis	_____
Mr. Soyars	_____
Mr. Walters	_____
Tele. Room	_____
Mr. Kinley	_____
Mr. Armstrong	_____
Ms. Herwig	_____
Mr. Neenan	_____

NR12 SD PLAIN

TELETYPE

11:45 PM 1/15/73 NITEL CAW

TO: ACTING DIRECTOR, FBI (157-23577)

ATTENTION: DID

FROM: SAN DIEGO (157-2815) (P)

SECRET ARMY ORGANIZATION (SAO). EXTREMIST MATTERS.

INVESTIGATOR LAWRENCE WILSON, SAN DIEGO DISTRICT ATTORNEY'S OFFICE, ADVISED THAT JERRY LYNN DAVIS, SAO LEADER, ENTERED A PLEA OF GUILTY TO A CHARGE OF POSSESSION OF EXPLOSIVE MATERIALS ON 1/15/73. THE PLEA WAS ENTERED BEFORE SAN DIEGO COUNTY SUPERIOR COURT JUDGE FRANKLIN B. ORFIELD WHO SET SENTENCING FOR 2/26/73. A CHARGE OF RECEIVING STOLEN PROPERTY WAS DISMISSED ON MOTION OF DEPUTY DISTRICT ATTORNEY RICHARD NEELY FOLLOWING DAVIS' GUILTY PLEA.

*Handwritten notes:*  
*G. & M. Miller*

SAN DIEGO WILL REPORT SENTENCING OF DAVIS.

END

REC-3

157-23577-85

TMT FBI WA CLR

3 JAN 19 1973

57 JAN 24 1973

Deleted Copy Sent Douglas Parker  
 by Letter 1/14/73  
 Per FOIA Request cc

cc MR. TRAINOR  
 ROOM 712-A 9&D

*Handwritten signatures:*  
 3. [Signature]  
 De [Signature]



## Memorandum

TO : ACTING DIRECTOR, FBI

DATE: 1/10/73

FROM: SAC, LOS ANGELES (9-4858) (P)

SUBJECT: UNSUBS;  
IRVING SARNOFF - VICTIM  
RUTH SARNOFF - VICTIM  
EXTORTION  
OO: Los Angeles

Additional copies of this communication are being furnished the Bureau for inclusion in appropriate Bufiles as listed below. An information copy is also being furnished San Diego for file 157-2815 concerning Secret Army Organization (SAO), with the four (4) enclosures described below.

Enclosed for the Bureau for inclusion in the Anonymous Letter File are two copies each of the following:

1. Copy of envelope addressed in typing to IRVING and RUTH SARNOFF. 3300 North Ivar Street, Rosemead, California 91770, postmarked 12/21/72 at El Monte, California, bearing typed return of S.A.O., Post Office Box 5791, San Diego, California 92105.

- ⑥ - Bureau (Enc. 8) (AM)
- |                  |              |
|------------------|--------------|
| (1 - 100-376150) | (I. SARNOFF) |
| (1 - 100-375343) | (R. SARNOFF) |
| (1 - 100-408448) | (P. CHRONIS) |
| (1 - 157-23577)  | (SAO)        |
| (1 - 62-107251)  | (MINUTEMEN)  |
- 1 - San Diego (Enc. 4) (157-2815) (SAO) (Info)
- 7 - Los Angeles
- |                 |              |        |
|-----------------|--------------|--------|
| (1 - 100-28093) | (I. SARNOFF) | (ADEX) |
| (1 - 100-31957) | (R. SARNOFF) |        |
| (1 - 100-45409) | (P. CHRONIS) |        |
| (1 - 157-7318)  | (SAO)        |        |
| (1 - 157-5063)  | (MINUTEMEN)  |        |

JOS/vmk  
(14)

FEB 2 1973 ENCLOSURE

157-2815-  
NOT RECORDED

47 JAN 23 1973

ORIGINAL FILED IN 157-2815-7

2. Copy typed holiday card starting "Congratulations- you have been selected as our #1 target for 173-...".
3. Copy of printed statement on piece of paper 3½ by 4½ inches. At the top center appears a circle with cross hairs, and below is the caption "Traitors Beware". After the statement appears the signature "Minutemen S.A.O.".
4. Copy of Certificate of Appreciation to IRVING SARNOFF at Christmas season 1972 from National Police Officers Association of America.

Xerox copies of the above four items were enclosed with a letter dated 1/4/73, received by the Los Angeles Office on 1/9/73, from PHILLIP CHRONIS, attorney, 5143 Sunset Boulevard, Los Angeles, California. CHRONIS indicated in his letter that IRVING and RUTH SARNOFF were his clients, and had been receiving telephonic death threats as the result of their political activities. CHRONIS wrote that these have escalated to the point of written death threats, which was why he was enclosing the above items. CHRONIS also included with his letter a copy of a virtually similar letter dated 1/4/73, addressed to ROBERT A. HOUGHTON, Director, Division of Law Enforcement, Office of the Attorney General, Department of Justice, State Building, Los Angeles. Both letters closed with the statement that CHRONIS believed that the primary responsibility for investigation of this matter rested with the FBI.

The above matter was discussed on 1/9/73 with Assistant United States Attorney (AUSA) BRIAN J. O'NEILL, Chief, Criminal Complaints, United States Attorney's Office, Los Angeles. Mr. O'NEILL advised he would decline prosecution in this matter since there was insufficient evidence to prove a violation of the Federal Extortion Statute as no specific or direct threat was contained in the letters to the SARNOFFs, as furnished by CHRONIS.

CHRONIS was advised of AUSA O'NEILL's opinion on 1/9/73. He stated he had rather expected such would be the case. He was further advised that if the SARNOFFs feared for their personal safety, they should contact local police authorities. He retorted, among other things, that he did not feel this would solve anything, and he could see no justification for the FBI not proceeding on an

investigation which appeared obvious on its face, such as first finding out who belonged to the return address on the letter to his client. In this regard he stated that "there seems to be some matters even the novice investigator would know enough to investigate". It was patiently explained to CHRONIS that the FBI is strictly an investigative agency, and a decision to prosecute, or not to prosecute, an alleged violation of Federal law is strictly the responsibility of the United States Attorney. CHRONIS replied that he would probably proceed further in the matter, and the conversation was terminated.

For information of the Bureau, Minutemen literature identical to item three above has been widely distributed throughout the United States to various individuals. The Secret Army Organization(SAO) was formed in San Diego, California, in late September 1971, to replace the Minutemen organization considered defunct in the San Diego area. Los Angeles files reveal Post Office Box 5791, San Diego, is a mail drop for SAO.

The National Police Officers Association of America is well known to the Bureau, and was referred to in SAC Letter 55-77 and SAC Letter 61-27.

Los Angeles files reveal IRVING G. SARNOFF is the subject or victim of the following:

1. "IRVING G. SARNOFF  
SM-C (KEY ACTIVIST)  
Bufile 100-376150  
LA file 100-28093"
2. "UNSUBS;  
IRVING SARNOFF - VICTIM  
CIVIL RIGHTS  
LA file 44-2355"
3. "UNSUBS;  
MARQUERITE MAY BUCKLEY - VICTIM  
IRVING SARNOFF - VICTIM  
ET AL  
CIVIL RIGHTS  
LA file 44-2262"

SARNOFF's wife, DOROTHY RUTH SARNOFF, is the subject

LA 9-4858

of a security investigation, Bufile 100-375343, Los Angeles file 100-31957.

SARNOFF's attorney PHILLIP CHRONIS is the subject of a closed security investigation in the Los Angeles Office, Bufile 100-408448, Los Angeles file 100-45409.

Pertinent and appropriate information concerning the material forwarded by CHRONIS was furnished on 1/9/73, to CHARLES YARTON, Postal Inspector Coordinator for Bombing Investigations, United States Postal Service, Los Angeles. YARTON advised that he was knowledgeable concerning the background and activities of IRVING SARNOFF. YARTON is aware that a member of SAO in San Diego was sentenced in December 1972 for bombing a San Diego theater, and was very appreciative of receiving the information.

The opinion of AUSA O'NEILL will be confirmed by separate communication.

S.A.O.  
P.O. BOX 5791  
SAN DIEGO, CA, 92105

EL MONTE, CA  
DEC 21  
PM  
1972

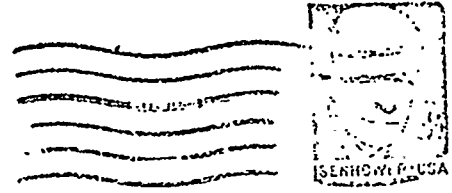

IRVING & RUTH SARNOFF

3330 N. IVAR ST.

ROSEMEAD, CA. 91770

9

ENCLOSURE

157-23577-

*And best wishes for a Happy New Year*

CONGRATULATIONS--YOU HAVE BEEN SELECTED  
AS OUR #1 TARGET FOR '73--SO BEWARE YOU  
BALDHEADED COMMUNIST TREITOR--WE ARE THROUGH  
PLAYING GAMES AND THE NEXT BOX YOU RECEIVE  
WILL NOT BE CANDY! !

P.S. HOW DO YOUR KIDS LIKE THAT  
LEAVING SCHOOL IN TEMPLE CITY!

REMEMBER--OUR CROSS HAIRS  
ARE ON YOUR HEAD!

ENCLOSURE

157-23577-

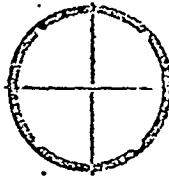

### TRAITORS BEWARE

See the old man at the corner where you buy your papers? He may have a silencer equipped pistol under his coat. That extra fountain pen in the pocket of the insurance salesman who calls on you might be a cyanide gas gun. What about your milk man? Arsenic works slow but sure. Your auto mechanic may stay up nights studying booby traps. These patriots are not going to let you take their freedom away from them. They have learned the silent knife, the strangler's cord, the target rifle that hits sparrows at 200 yards. Traitors beware! Even now the cross hairs are on the back of your necks.

### MINUTEMEN

S.A.O.

ENCLOSURE

157-23577-

# National Order of the *Knights of the* *Police* of America

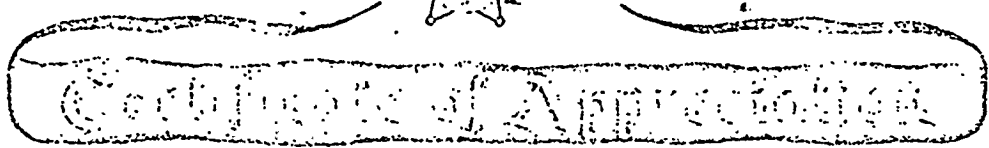

is hereby presented to  
**IRVING SARNOFF , SPECIAL AGENT**

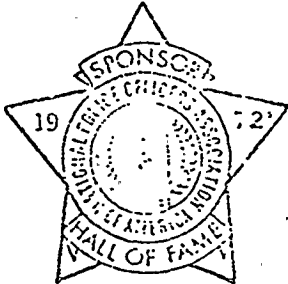

issued in appreciation and recognition of the assistance rendered by you as a distinguished citizen of your community in support of the law enforcement profession and their fight in the war against crime in your city and this nation.

given this Christmas Season 1972

*Frank J. Schira*  
EXECUTIVE DIRECTOR  
Police Hall of Fame

HI IRV  
THANKS AGAIN FOR THE JOB YOU HAVE  
DONE FOR US! I THOUGHT YOU WOULD LIKE  
TO KNOW THAT THE BOARD HAS VOTED A  
RAISE FOR YOU. PLEASE SAY HI TO RUTH.

F.J.S.

ENCLOSURE

157-23577-



airtel

To: SACs, Sacramento  
San Diego  
Los Angeles

1/5/73

From: Acting Director, FBI

SECRET ARMY ORGANIZATION (SAO)  
SACRAMENTO DIVISION  
EXTREMIST MATTERS  
SCfile: 157-2195

1 - San Francisco Field  
Guidance Folder  
1 - Mr. R. W. Held

TAX REBELLION COMMITTEE (TRC)  
EXTREMIST MATTERS -  
WHITE HATE GROUP  
SCfile: 157-1947

ReSCairtel 12/13/72 entitled "Francis Earl Gillings, Alleged Plot to Kill the President - Conspiracy, 00:SC."

In addition to your Alleged Plot to Kill the President investigation of Francis Earl Gillings (SCfile: 175-75), Sacramento should also, if not already done, open a 157 case on him for pertinent extremist information.

In connection with your preliminary investigation of the TRC, Sacramento should identify the anti-Jewish, anti-Negro tax rebellion group which met on 12/5/72 at Fresno, California, which is mentioned on Page 3 of referenced airtel. In the event you find the aforementioned group was not the TRC, which is also headquartered in Fresno, make a recommendation regarding extremist matter investigation necessary.

ORIGINAL FILED IN

RWH:aso (13)

SEE NOTE PAGE TWO

~~JAN 1973~~

MAILED 6  
JAN 4 1973  
FBI

REC-49 157-23577-84

ST-104

GLM

19 JAN 5 1973

an  
and  
dt  
l  
E.S.  
rom  
y  
from  
an

MAIL ROOM  TELETYPE UNIT

Airtel to Sacramento, et al.  
Re: Secret Army Organization (SAO);  
Tax Rebellion Committee (TRC)

With respect to the National Association to Keep and Bear Arms referred to in referenced airtel, you should through established sources discreetly ascertain nature of its activities, identities of its officers, relationship with SAO or other extremist groups, and any other pertinent information which will assist in making a determination as to whether an extremist-type investigation should be initiated. Expedite and furnish FBIHQ your recommendation in this regard.

Sacramento and Los Angeles review indices and conduct a discreet inquiry through established sources to identify Reverend Gail mentioned on Page 3 of referenced airtel. Los Angeles make a recommendation as to whether active investigation should be conducted.

San Diego conduct necessary investigation to identify **INFORMANT** and determine the extent of his involvement in extremist activity. It is noted Calvin Hendell Fox, Bufile 157-2033, SDfile 157-3170, is a known associate of the SAO.

NOTE:

The TRC is an organization ostensibly designed to challenge taxation and embarrass the Internal Revenue Service (IRS). Limited investigation to date suggests the possible involvement or influence of the extremist SAO, Minutemen organization, and a group calling itself National Association to Keep and Bear Arms on the TRC and/or its membership. Gillings, 41-year-old male Caucasian who operates a service station in Tracy, California, has been involved with the TRC and has stated the country is on the verge of collapse and some people in the movement were planning to assassinate the President, Vice President, and others of "leftist tendencies." Gillings is also being investigated in a Threat Against the President matter. Liaison being maintained with Secret Service and IRS.

Domestic Intelligence Division

INFORMATIVE NOTE

Date 1/10/73

You were previously advised that William Francis Yakopec, member of the Secret Army Organization, was sentenced on 10/24/72 to one year to life imprisonment in Superior Court, San Diego County, San Diego, California after having been found guilty of bombing a San Diego theater. Before sentencing, Yakopec admitted in court that he bombed the theater, thus substantiating testimony given during the trial by former FBI informant Howard Barry Godfrey.

Attached reports that on 1/4/73 Richard Edward Bradley, also known as Dino Martinelli, was sentenced to 1 to 14 years by San Diego County Superior Court for perjury in the Yakopec trial. Bradley testified to the sale of firearms to Godfrey but entered a guilty plea to the perjury charge.

Copy of attached being sent to Secret Service and Internal Security Division of the Department.

HEM:jaw

EM/HEM

GCM/ICD WAC

83

BUREAU OF INVESTIGATION  
COMMUNICATIONS SECTION

JAN 09 1973

TELETYPE

Mr. Baker	_____
Mr. Callahan	_____
Mr. Cleveland	_____
Mr. Conrad	_____
Mr. DeLoach	_____
Mr. Felt	_____
Mr. Gale	_____
Mr. Rosen	_____
Mr. Sullivan	_____
Mr. Tavel	_____
Mr. Trotter	_____
Mr. Tele. Room	_____
Mr. Holmes	_____
Mr. Gandy	_____

NR 10SD CODE

220PM 1-9-73 NITEL MJZ

TO: ACTING DIRECTOR, FBI(157-23577)

ATTENTION: DID

FROM: SAN DIEGO (157-2815) (P)

*H. Malone*

SECRET ARMY ORGANIZATION (SAO). EXTREMIST MATTERS.

REFERENCE

RZ SAN DIEGO TELETYPE 1-3-73.

ON 1-9-73 INVESTIGATOR LAWRENCE WILSON, SAN DIEGO COUNTY DISTRICT ATTORNEY'S OFFICE, SAN DIEGO, CALIFORNIA, ADVISED THAT ON 1-4-73, DINO MARTINELLI WAS SENTENCED TO ONE TO FOURTEEN YEARS IN THE CALIFORNIA STATE PRISON BY SAN DIEGO COUNTY SUPERIOR COURT JUDGE FRANKLIN B. ORFIELD FOR PERJURY IN THE TRIAL OF WILLIAM FRANCIS YAKOPEC WHO WAS FOUND GUILTY OF CHARGES RESULTING FROM THE BOMBING OF THE GUILD THEATRE IN SAN DIEGO.

*[Handwritten mark]*

MARTINELLI HAD TESTIFIED TO THE SALE OF FIREARMS TO HOWARD BARRY GODFREY, FORMERLY **INFORMANT** MARTINELLI ENTERED A PLEA OF GUILTY TO THE CHARGE OF PERJURY.

REC-10 157-23577-83

3 JAN 11 1973

END PAGE ONE

Deleted Copy Sent Douglas Porter  
by Letter 9/14/75  
Per FOIA Request 017

*5- M...*

55 JAN 16 1973

PAGE TWO

SD 157-2815

JUDGE ORFIELD ADVISED MARTINELLI THAT A MUNICIPAL COURT DOES NOT HAVE AUTHORITY TO CHANGE HIS NAME AND THAT THEREFORE HIS NAME REMAINS RICHARD EDWARD BRADLEY. MARTINELLI HAD TOLD THE COURT THAT HIS NAME WAS CHANGED BY THE OXNARD MUNICIPAL COURT.

END

JRM FBI WASH DC

CLR

*CC-Traison*

Domestic Intelligence Division

INFORMATIVE NOTE

Date 1/4/73

Attached reports the sentencing of two members of the white extremist Secret Army Organization (SAO) in Superior Court, San Diego County, California. Convictions resulted from information furnished by a former FBI extremist informant.

George Mitchell Hoover was sentenced to five years to life imprisonment on charges involving his shooting into a private home.

Calvin Hendell Fox received a probationary sentence for perjury in trial of William Francis Yakopec, another SAO member. Fox was indicted for perjury for denying SAO membership and alleging the FBI planted material in his personal files.

Copy furnished Internal Security Division of the Department.

CAM:was

CAM

CCM/ICD

WGC

EMWAS

J III  
1-4  
9:27P

BRK

JAN 04 1973

TELETYPE

- Mr. Felt \_\_\_\_\_
- Mr. Baker \_\_\_\_\_
- Mr. Callahan \_\_\_\_\_
- Mr. Cleveland \_\_\_\_\_
- Mr. Conrad \_\_\_\_\_
- Mr. Dalbey \_\_\_\_\_
- Mr. Gebhardt \_\_\_\_\_
- Mr. Jenkins \_\_\_\_\_
- Mr. Marshall \_\_\_\_\_
- Mr. Miller, E.S.
- Mr. Purvis
- Mr. Soyars \_\_\_\_\_
- Mr. Walters \_\_\_\_\_
- Tele. Room \_\_\_\_\_
- Mr. Kinley \_\_\_\_\_
- Mr. Armstrong \_\_\_\_\_
- Ms. Herwig \_\_\_\_\_
- Mr. Neenan \_\_\_\_\_

NR 10 SD PLAIN

9:21PM NITEL 1/3/73 LLC

TO ACTING DIRECTOR (157-23577) (ATTN: D I D)  
FROM SAN DIEGO (157-2815) (P) 2 P

SECRET ARMY ORGANIZATION (SAO); EXTREMIST MATTERS.

*R. Johnson*

DEBBIE EGLEY, CLERK, RECORDS SECTION, SAN DIEGO COUNTY DISTRICT ATTORNEY'S OFFICE, SAN DIEGO, CALIFORNIA, ADVISED ON DECEMBER TWENTYNINE, SEVENTYTWO, THAT CALVIN HENDELL FOX WAS SENTENCED ON DECEMBER TWENTYTWO SEVENTY TWO TO FIVE YEARS PROBATION, SIX MONTHS IN CUSTODY TO BE CREDITED WITH TIME ALREADY SPENT IN CUSTODY AND WAS ADVISED OF HIS RIGHTS TO APPEAL, FOR PERJURY IN THE WILLIAM FRANCIS YAKOPEC TRIAL WHERE HE TESTIFIED THAT THE FBI HAD PLANTED EVIDENCE THAT HE WAS AN SAO MEMBER IN HIS FILES AND THAT HE WAS NOT A MEMBER. FOX IS THE SUBJECT OF SAN DIEGO FILE 157-3170 AND BUFILE 157-2033.

*of*  
*5-10-73*

ON 1/3/73, LAWRENCE WILSON, INVESTIGATOR, SAN DIEGO COUNTY DISTRICT ATTORNEY'S OFFICE, SAN DIEGO, CALIFORNIA ADVISED THAT ON 1/2/73, GEORGE MITCHELL HOOVER, SAO MEMBER, WAS SENTENCED TO 5 YEARS TO LIFE IN PRISON ON THREE CHARGES INVOLVING THE SHOOTING INTO THE HOME OF RADICAL

REC-3

*157-2571-82*

21 JAN 9 1973

EX-105

END PAGE ONE  
58 JAN 12 1973

Deleted Copy Sent *Douglas Perlin*  
by Letter *9/1/75*  
Per FOIA Request *OK*

*1cc 1SD*  
*1cc CRD*  
*R/S*  
*1/21/73*

PAGE TWO

SD 157-2815

PROFESSOR PETER BOHMER ON 1/6/72. HE WAS  
CHARGED WITH ASSAULT WITH A DEADLY WEAPON, FIRING  
INTO AN OCCUPIED DWELLING AND POSSESSION OF A BILLY CLUB.  
HOOVER WAS SENTENCED BY SAN DIEGO SUPERIOR COURT JUDGE  
WILLIAM T. LOW. HOOVER IS SUBJECT OF SAN DIEGO FILE  
157-3017, AND BUFILE 157-17513.

WILSON ADVISED THAT DINO MARTENILLA, ALSO CHARGED  
WITH PERJURY IN THE YAKOPEC TRIAL WILL BE SENTENCED ON  
1/4/73.

ABOVE CONVICTIONS RESULTED FROM INFORMATION  
FURNISHED BY FORMER **INFORMANT**

SAN DIEGO WILL SUBMIT LHM RE SENTENCING  
OF ALL SAO MEMEBRS ON TRIAL.

END

TMT BXXX FBI SOG

CLR

cc MR. TRAFOR  
ROOM 712-A 9&D



airtel

12/7/72

To: SAC, Sacramento

From: For the Acting Director, FBI  
W. Mark Felt  
Acting Associate Director

- 1 - Sacramento
- Field Guidance
- 1 - Mr. R. W. Held

SECRET ARMY ORGANIZATION (SAO)  
 SACRAMENTO DIVISION  
 EXTREMIST MATTERS  
 SCfile: 157-2195

*Amh 9*

TAX REBELLION COMMITTEE (TRC)  
 EXTREMIST MATTERS - WHITE HATE GROUP  
 SCfile: 157-1947

ReSClet and LHM 11/21/72 entitled "James Walter Scott, EM - WHG, OO:SC"; SCairtel and LHM 11/21/72 entitled "Tax Rebellion Committee, EM - WHG, OO:SC"; and SCTel 12/4/72 entitled "Francis Earl Gillings, EM - Threats Against the President."

Referenced communications indicated a similarity in the objectives and philosophy of the captioned organizations and a possible association between the two groups and/or their individual members.

Per provisions of Section 122, Manual of Instructions, regarding the investigation of white extremist organizations and individuals, Sacramento conduct necessary investigation to determine the extent of the SAO's presence in that division. If necessary, identify its leaders and membership, the location of its chapters and meetings, define its goals and activities, and comment on its relationship to the TRC. Open individual cases and develop background on those

MAILED 10  
 DEC - 7 1972  
 FBI

*157-23577-81*

- Felt \_\_\_\_\_
- Baker \_\_\_\_\_
- Callahan \_\_\_\_\_
- Cleveland \_\_\_\_\_
- Conrad \_\_\_\_\_
- Dalbey \_\_\_\_\_
- Gebhardt \_\_\_\_\_
- Jenkins \_\_\_\_\_
- Marshall \_\_\_\_\_
- Miller, E.S. \_\_\_\_\_
- Purvis \_\_\_\_\_
- Soyars \_\_\_\_\_
- Walters \_\_\_\_\_
- Tele. Room \_\_\_\_\_
- Mr. Kinley \_\_\_\_\_
- Mr. Armstrong \_\_\_\_\_
- Ms. Herwig \_\_\_\_\_
- Mrs. Neenan \_\_\_\_\_

RWH:aso (7)

ST-111

REC-18

SEE NOTE PAGE TWO DEC 8 1972

*150*

*R*

*RWH*

EDJ-102LICE  
REC'D FBI WIGGEB

*CCM/scr*

*5 DEC 15 1972*

MAIL ROOM  TELETYPE UNIT

Airtel to Sacramento

Re: Secret Army Organization (SAO);  
Tax Rebellion Committee (TRC)

persons active with the SAO and determine the extent of their involvement with it. Make a statement whether sufficient informant coverage is available and, if not, what corrective steps are being taken.

In view of the extremist remarks of individuals associated with the TRC, Sacramento conduct preliminary investigation to determine the extent of its membership's involvement in white extremist activity and other violations within the jurisdiction of the FBI. Maintain contact with established sources and informants for information regarding the TRC in those regards but make certain you do not interfere with pending prosecution against James Walter Scott, national chairman of the TRC, or infringe upon investigative responsibilities of the Internal Revenue Service or other agencies. As individuals listed as sponsors of the TRC have noted residences outside the Sacramento Division, insure appropriate field offices are advised of their involvement.

Submit results of your investigations of both organizations and individuals under respective case captions in form suitable for dissemination.

NOTE:

Individuals associated with the TRC and SAO in Sacramento Division have discussed methods of encouraging discontent with the Internal Revenue Service (IRS), the imminent collapse of the U. S. Government, and the eventual necessity of eliminating Government officials, including the President and Vice President, and others of "leftist tendencies." Sacramento should determine the extent of these organizations' activities. IRS has prosecution pending against James Walter Scott for income tax evasion. Secret Service aware of alleged threats.

FBI

Date: 12/13/72

Transmit the following in \_\_\_\_\_  
(Type in plaintext or code)

Via AIRTEL \_\_\_\_\_  
(Priority)

TO: ACTING DIRECTOR, FBI  
FROM: *J.P.C.* SAC, SACRAMENTO (175-55) (P)  
SUBJECT: FRANCIS EARL GILLINGS  
ALLEGED PLOT TO KILL THE  
PRESIDENT - CONSPIRACY  
OO: Sacramento

*pg 2*

Re Sacramento letter and LHM; 11/21/72, entitled, "JAMES WALTER SCOTT, EM - WIC, OO: Sacramento"; Sacramento airtel and LHM, 11/21/72, entitled, "TAX REBELLION COMMITTEE, EM - WIC, OO: Sacramento"; Sacramento nitel to the Bureau,

- 4 - Bureau
- (2) - 175- (FRANCIS EARL GILLINGS)
- (1) - 175-23577
- (1 - 157-21670)
- 2 - Albuquerque (Enc. 3)
- 2 - Chicago (Enc. 3)
- 2 - Detroit (Enc. 3)
- 2 - Kansas City (Enc. 3)
- 3 - Los Angeles (Enc. 2)
- 2 - Mobile (Enc. 3)
- 3 - Phoenix (Enc. 2)
- 2 - Portland (Enc. 3)
- 3 - San Diego (157-2815)(Enc. 2)
- 2 - San Francisco (Enc. 3)
- 9 - Sacramento
  - (2 - 175-55) (1 - 157-2552)
  - (1 - 157-1947) (1 - 157-2569)
  - (1 - 157-2195) (1 - 170-304)
  - (1 - 157-2493) (1 - ELKBA.) (DEAD)

~~DEC 16 1972~~

NOT RECORDED

78 DEC 27 1972

59 TML:hjr  
JAN 4 1973

Approved: \_\_\_\_\_ Sent \_\_\_\_\_ M Per \_\_\_\_\_  
Special Agent in Charge

ORIGINAL FILED IN 100-11541-388

SC 175-55

12/4/72; and Bureau airtel to Sacramento, 12/7/72, captioned, "SECRET ARMY ORGANIZATION (SAO), SACRAMENTO DIVISION, EM" and "TAX REBELLION COMMITTEE (TRC), EM - WHG".

Enclosed for Albuquerque, Chicago, Detroit, Kansas City, Mobile, Portland, and San Francisco is one copy each of referenced Sacramento communications.

Enclosed for San Diego is one copy each of Sacramento letter and LHM; airtel and LHM, both dated 11/21/72.

Enclosed for Los Angeles is one copy each of Sacramento airtel and LHM, 11/21/72, and nitel, 12/4/72.

Enclosed for Phoenix is one copy each of letter and LHM, dated 11/21/72 and nitel, 12/4/72.

On 12/5/72, the Bureau advised that information contained in Sacramento nitel to the Bureau, 12/4/72, indicated a possible violation of the assaulting the President of the United States statute and advised Sacramento to immediately institute appropriate investigation in this matter.

By referenced Bureau airtel to Sacramento, 12/7/72, Sacramento was instructed to conduct necessary investigation to determine the extent of the Secret Army Organization's (SAO) presence in this division and comment on its relationship to the Tax Rebellion Committee (TRC).

In addition, the Bureau advised that in view of the extremist remarks of individuals associated with the TRC, preliminary investigation was to be conducted to determine the extent of the TRC's membership's involvement in white extremist activity and other violations within the jurisdiction of the FBI. The Bureau advised that Sacramento was to maintain contact with established sources and informants for

SC 175-55

information regarding the TRC in the above regards but to make certain not to interfere with pending prosecution against JAMES WALTER SCOTT, National Chairman of the TRC, or infringe upon investigative responsibilities of the Internal Revenue Service or other agencies.

In addition, the Bureau has advised that results of investigations of the SAC and TRC are to be submitted in a form suitable for dissemination under respective captioned cases.

In a letter captioned Tax Rebellion Committee, contained in referenced Sacramento airtel and LHM to the Bureau, dated 11/21/72, the leadership of the TRC is set forth. All offices are to review this letter for individuals listed within their territory.

On 12/5/72, **INFORMANT** advised a meeting was held 12/5/72 at Fresno, California, by a group of persons who do not go by a specific name but who are very anti-Jewish and anti-Negro as well as a tax rebellion group. There were about fifty persons in attendance at this meeting and the speaker was Reverend GAIL from the Los Angeles area.

Source stated that GAIL's speech was extremely anti-Negro and Jew and that he (GAIL) claimed they had to get tough with all the Jewish communists who run congress. GAIL said that this country has to be cleaned up and the only way to accomplish this would be to kill every FBI Agent and every IRS Agent. GAIL further stated that the FBI and IRS Agents should not only be killed but also hung from every telephone pole and mutilated.

Source further related that PAUL TODD claimed he was director of a chapter of the National Association to Keep and Bear Arms (NAKBA), and he lives at P. O. Box 147, Madera, California. TODD further claimed that JIM SCOTT had

connections in many of the MKBA groups. TODD went on to state that his organization had to be very careful with what they did so that they would not be thought of as the "Secret Army Organization" because some of the people in this organization were radical and thought like the SAO.

Source advised that TODD said all of these organizations like SCOTT's, TRC, the MKBA, and the SAO had to stay in an informal connection with each other so that when the big revolt came, they could all unite; but they should not be too closely united yet or they would be caught and thrown in jail.

On 12/5/72, Lieutenant CLOYCE BROCKSHIRE, Tracy Police Department, advised his files reflect that FRANCIS GILLINGS was arrested 12/8/61 by the Marysville Sheriff's Office, Marysville, California, number A18833, for petty theft and received one year probation.

BROCKSHIRE further advised that his records reflect that GILLINGS has purchased four weapons which include a .32 automatic, a .38 revolver, a .22 revolver, and a .22 automatic.

On 12/7/72, Sergeant KENNETH WAGNER, Intelligence Division, San Joaquin County Sheriff's Office (SJSO), advised his files contain no arrest record for subject; however, his department has contacted GILLINGS on several occasions in regards to GILLINGS confronting his customers with a revolver when he thought they were trying to cheat him. WAGNER advised his intelligence records indicate GILLINGS operates an Arco gas station at U. S. 580 and Patterson Pass Road, Tracy, California, and that he moved to Tracy in 1962 from South Dakota. GILLINGS is married, has four sons, who attend local Tracy schools, and he ran for State Assembly on the American Independent Party ticket.

WAGNER advised that his files indicate subject is "ultra-right wing" and they consider him to be potentially dangerous.

SC 175-55

The following is a description of FRANCIS EARL GILLINGS:

Race:	Caucasian
Sex:	Male
Date of birth:	7/27/31
Place of birth:	Academy, South Dakota
Height:	6' 3"
Weight:	180 pounds
Eyes:	Brown
Hair:	Brown
Social Security Number:	JFK Act 6 (3)
Address:	1826 East Street Tracy, California
California driver's license number:	H337723

On 12/8/72, **INFORMANT** advised that it was his understanding that "the movement", as referred to by FRANCIS GILLINGS in his threats against the President and Vice President, was, in fact, the SAO. Source advised that GILLINGS, to date, has not specifically mentioned that he is a member of the SAO. Source further advised that since GILLINGS had just returned from a meeting with JAMES WALTER SCOTT at Fresno, California, he felt the threats against the President were probably a result of GILLINGS discussion with SCOTT.

Source stated that GILLINGS was also very likely trying to impress source and others at the meeting as to his importance in "the movement"; however, in view of the seriousness of the threat, source would continue attempts to learn if this was, in fact, an actual plot against the President.

On 12/9/72, SC 1024-PEI advised that he had met with DAVID L. WILSON, a reported leader in the Stockton NAKBA, and that WILSON showed him a copy of a letter he received from the SAO, which is quoted as follows:

SC 175-55

"SECRET ARMY ORGANIZATION  
GENERAL HEADQUARTERS

URGENT

"To all members, supporters, and friends of the S.A.O. Arrests of many of the members in San Diego have caused some changes of strategy.

"All Post Office Boxes, Drops, Cutouts, and Courier Routes have been discontinued. It is imperative that you do not try to contact the organization in any manner.

"For the next few months our members are being directed to join the John Birch Society under assumed name. The purpose is three fold: The JBS needs the help that our professionals can lend; some of our members need the political training that the JBS can offer; the JBS is a fertile recruiting ground for more militant underground activities.

"You will be contacted at a much later date with further instructions.

"Best wishes and keep your powder dry.

**ARMANT**

"SAO General Staff

"CHD:dgt"

Source advised that according to pamphlets he received from WILSON, the MKBA has its national headquarters at 909 North Central Avenue, Medford, Oregon.



SC 175-55

Previous informant information received from Phoenix 783-E indicates that DAVID L. WILSON has been in communication with the SAO through JAMES KLEIMAN (SC 157-2493).

LEADS:

All offices contact informants and sources in the SAO and TRC and determine if there is a specific plot to assassinate the President and Vice President.

All offices target informants to determine involvement of members of TRC with white extremist activity.

PORTLAND

AT PORTLAND, OREGON. Will conduct preliminary investigation to determine extent of NAKBA membership involvement in white extremist activity.

SAN DIEGO

AT SAN DIEGO, CALIFORNIA. Insure all offices which have SAO chapters are aware of alleged plot to assassinate President and Vice President.

SACRAMENTO

AT FRESNO, CALIFORNIA. Will continue contact with SC 992-PEI and attempt to establish close coverage of the activities of JAMES WALTER SCOTT.

AT MARYSVILLE, CALIFORNIA. Will review subject's arrest and parole record, Sheriff's Office number A18833, for background information.

AT STOCKTON, CALIFORNIA. Will maintain coverage of subject and associates through **INFORMANT**

SC 175-55

IN VIEW OF GILLINGS' STATEMENTS, HE SHOULD BE  
CONSIDERED ARMED AND DANGEROUS.

## Domestic Intelligence Division

## INFORMATIVE NOTE

Date 12/7/72

\* You have been advised earlier of trial of Calvin Hendell Fox, member of white extremist Secret Army Organization (SAO), in Superior Court, San Diego County, San Diego, California. Fox was indicted for perjury for denying SAO membership and for alleging FBI planted material in his personal files. Trial began 12/5/72. You were also advised SA Earl M. Petersen would testify for the prosecution, if needed, in order to qualify former FBI informant Howard Barry Godfrey, another prosecution witness. Matter coordinated with Inspector John Mintz, Office of Legal Counsel.

Attached reports that on 12/6/72, Fox found guilty of perjury charges and remanded to custody of San Diego County Sheriff pending sentencing. SA Petersen did not testify nor was it necessary to recall SA Arthur J. Hooper for rebuttal testimony after his testimony for the prosecution. Conviction of Fox resulted from information furnished by former informant Godfrey regarding SAO members.

HEM:jaw

EM/HEM

CCM/SLP WCC

80

NR 10 SD PLAIN

DEC 07 1972

10:36 PM NITEL 12-06-72 GKF

TELETYPE

TO ACTING DIRECTOR (157-23577)

W. MARK FELT, ACTING ASSOCIATE DIRECTOR

(ATTN: D. I. D)

FROM SAN DIEGO (157-2815)

Mr. Callahan	_____
Mr. Cleveland	_____
Mr. Conrad	_____
Mr. Dalbey	_____
Mr. Gebhardt	_____
Mr. Jenkins	_____
Mr. Marshall	_____
Mr. Miller	_____
Mr. Purvis	_____
Mr. Soyars	_____
Mr. Walters	_____
Tele. Room	_____
Mr. Kinley	_____
Mr. Armstrong	_____
Ms. Herwig	_____
Mr. Neenan	_____

SECRET ARMY ORGANIZATION (SAO)  
EXTREMIST MATTERS.

*Handwritten signature: J. G. Mason*  
*Handwritten initials: JG*

RE SAN DIEGO NITEL TO BUREAU DECEMBER FIFTH LAST.

ON DECEMBER SIXTH INSTANT INVESTIGATOR LAWRENCE F. WILSON  
SAN DIEGO COUNTY DISTRICT ATTORNEY'S OFFICE SAN DIEGO, CALIFORNIA,  
ADVISED THAT CALVIN HENDELL FOX WAS FOUND GUILTY ON DECEMBER  
SIXTH INSTANT OF THE PERJURY CHARGES RESULTING FROM HIS TESTIMONY  
IN THE TRIAL OF WILLIAM FRANCIS YAKOPEC WHEN HE TESTIFIED THAT  
THE FBI PLANTED EVIDENCE OF SAO MEMBERSHIP IN HIS FILES. FOX  
WAS REMANDED TO THE CUSTODY OF THE SAN DIEGO COUNTY SHERIFF  
PENDING SENTENCING.

*Handwritten: REC-70 1-7-23517-80*

SA EARL M. PETERSEN DID NOT TESTIFY IN THIS CASE AND IT WAS  
NOT NECESSARY TO RECALL SA ARTHUR J. HOOPER FOR REBUTTAL TESTIMONY  
AFTER HIS TESTIMONY FOR THE PROSECUTION.

DEC 11 1972

THE CONVICTION OF FOX RESULTS FROM INFORMATION FURNISHED BY  
HOWARD BARRY GODFREY, FORMERLY **INFORMANT** REGARDING  
MEMBERS OF THE SAO.

*Handwritten: 59 DEC 18 1972*

END  
MR. TRINOR  
ROOM 712-A  
Deleted Copy Sent by Letter  
Per FOIA Request

*Handwritten signature*

TMT FBI SOG

Domestic Intelligence Division

INFORMATIVE NOTE

Date 12/6/72

Calvin Hendell Fox, member of white extremist Secret Army Organization (SAO), is presently on trial in Superior Court, San Diego County, San Diego, California. Fox indicted for perjury for denying SAO membership and for alleging FBI planted material in his personal files. Trial commenced 12/5/72.

Attached indicates SA Earl M. Petersen requested to testify for prosecution in trial of Fox to qualify former FBI informant Howard Barry Godfrey, another prosecution witness. Assistant U. S. Attorney John R. Neese, San Diego, cleared testimony with Deputy Assistant Attorney General Kevin T. Maroney, Internal Security Division and FBIHQ telephonically advised. SA Petersen will testify if needed and AUSA will be present. Matter coordinated with Inspector John Mintz, Office of Legal Counsel.

CAM:aso/bak

EM/HEM

GCM

W46

SA  
GAM

FEDERAL BUREAU OF INVESTIGATION  
COMMUNICATIONS SECTION

*X*

Mr. Baker	_____
Mr. Callahan	_____
Mr. Cleveland	_____
Mr. Conrad	_____
Mr. Dalbey	_____
Mr. Gellert	_____
Mr. Johnson	_____
Mr. Lester	_____
Mr. Quinn	_____
Mr. S. S.	_____
Mr. Purvis	_____
Mr. Soyars	_____
Mr. Walters	_____
Tele. Room	_____
Mr. Kinley	_____
Mr. Armstrong	_____
Ms. Herwig	_____
Mr. Neenan	_____

NR 12 SD PLAIN

DEC 06 1972

10:42 PM NITEL 12-05-72 GKF

TELETYPE

TO ACTING DIRECTOR (157-23577)

W. MARK FELT, ACTING ASSOCIATE DIRECTOR

ATTENTION: DID

FROM SAN DIEGO (157-2815)

SECRET ARMY ORGANIZATION (SAO)

EXTREMIST MATTERS.

*G. [Signature]*

RE SAN DIEGO TELEPHONE CALL TO BUREAU DECEMBER FIVE INSTANT.

THE TRIAL OF CALVIN HENDALL FOX FOR PERJURY IN TESTIMONY

DURING THE TRIAL OF WILLIAM FRANCIS YAKOPEC IS UNDER WAY IN SAN DIEGO COUNTY SUPERIOR COURT.

*5- [Signature]*

SA ARTHUR J. HOOPER HAD BEEN SUBPOENED TO TESTIFY IN THIS CASE AND HAD BEEN GIVEN AUTHORITY TO TESTIFY BY DEPUTY ASSISTANT ATTORNEY GENERAL KEVIN T. MARONEY ON NOVEMBER TWENTY LAST. HOOPER TESTIFIED ON DECEMBER FIFTH INSTANT WITHOUT INCIDENT.

REC-66 157-23577-79

*79*

AT NOON ON DECEMBER FIFTH INSTANT SA EARL M. PETERSEN WAS REQUESTED TO ATTEND A CONFERENCE IN THE OFFICE OF DEPUTY DISTRICT ATTORNEY L. FORREST PRICE WHO IS PROSECUTING THE CASE AGAINST FOX. PRICE ADVISED SA PETERSEN THAT IT MIGHT BE DESIREABLE TO HAVE SA PETERSEN TESTIFY TO THE FACT THAT HOWARD BARRY GODFREY WAS ASSOCIATED WITH THE FBI AS AN INFORMANT. PRICE WAS ADVISED THAT SA PETERSEN COULD NOT TESTIFY WITHOUT PREVIOUS AUTHORITY OF THE ATTORNEY GENERAL. AUSA JOHN R. NEECE WHO WAS PRESENT AT THE CONFERENCE TELEPHONICALLY CONTACTED MR. MARONEY AT THE JUSTICE DEPARTMENT AND SECURED HIS

DEC 3 1972

END PAGE ONE

AUTHORITY FOR PETERSEN'S TESTIMONY IN THE FOX CASE PROVIDED THAT SA PETERSEN TESTIFIED ONLY TO QUESTIONS PREVIOUSLY APPROVED IN THE YAKOPEC AND GEORGE MITCHELL HOOVER TRIALS.

THE BUREAU WAS ADVISED BY TELEPHONE OF THE REQUEST THAT PETERSEN TESTIFY TO THE FOLLOWING QUESTIONS TO QUALIFY GODFREY AS A WITNESS: NAME? OCCUPATION? HOW LONG ASSIGNED TO SAN DIEGO? DO YOU KNOW HOWARD GODFREY? HOW LONG HAVE YOU KNOWN HIM? WHAT WAS YOUR RELATIONSHIP WITH HIM? FOR HOW LONG DID HE CONTACT YOU WHEN STEVEN CHRISTENSEN WAS NOT AVAILABLE?

AFTER SOME DISCUSSION, PRICE DECIDED NOT TO CALL SA PETERSEN FOR DIRECT TESTIMONY WHICH WOULD ALLOW THE DEFENSE TO CROSS EXAMINE. PRICE REQUESTED THAT SA PETERSEN AND SA HOOPER STAND BY FOR POSSIBLE REBUTTLE QUESTIONS BY THE PROSECUTION WHICH FOR SA PETERSEN WOULD INCLUDE ONLY THOSE QUESTIONS LISTED ABOVE.

*ASSISTANT U.S. ATTORNEY*

AUSA JOHN R. NEECE WILL BE PRESENT AT ANY REBUTTAL TESTIMONY BY SAS PETERSEN OR HOOPER.

*UNLESS ADVISED TO THE CONTRARY BY THE BUREAU*

JACB SA PETERSEN WILL TESTIFY TO REBUTTAL QUESTIONS LISTED ABOVE IF SO REQUESTED BY SAN DIEGO COUNTY DEPUTY DISTRICT ATTORNEY.

*P PENDING*

END

TMT FBI SOG

ACK TWO CLR

CC MR. TRAINOR  
ROOM 712-A 9&D

DEC 06 1972

TELETYPE

Mr. Callahan	_____
Mr. Cleveland	_____
Mr. Conrad	_____
Mr. Dalbey	_____
Mr. Gerhardt	_____
Mr. Jenkins	_____
Mr. Marshall	_____
Mr. Miller, E.S.	_____
Mr. Purvis	_____
Mr. Sowers	_____
Mr. Walters	_____
Tele. Room	_____
Mr. Kinley	_____
Mr. Armstrong	_____
Ms. Hervoig	_____
Mrs. Neenan	_____

NR 09 SD PLAIN

10:40 PM 12-5-72 NITEL TLD

TO: ACTING DIRECTOR (157-23577)

W. MARK FELT, ACTING ASSOCIATE DIRECTOR

ATTENTION: DID

FROM: SAN DIEGO (157-2815) (P) 2P

*C. Callahan*

SECRET ARMY ORGANIZATION (SAO), EXTREMIST MATTERS.

RE BUREAU TELETYPE TO SAN DIEGO NOVEMBER TWENTY LAST.

ON DECEMBER FOUR LAST, INVESTIGATOR LAWRENCE K.

WILSON, SAN DIEGO COUNTY DISTRICT ATTORNEY'S OFFICE, SAN  
 DIEGO, CALIFORNIA, ADVISED THAT DINO E. MARTINELLI ENTERED  
 A PLEA OF GUILTY TO PERJURY BEFORE SAN DIEGO COUNTY SUPERIOR  
 COURT JUDGE FRANKLIN R. ORFIELD ON THAT DATE. MARTINELLI  
 LIED ON THE WITNESS STAND DURING THE TRIAL OF WILLIAM  
 FRANCIS YAKOPEC WHEN HE TESTIFIED THAT HE HAD SOLD ARMS TO

*Handwritten signature and large letter 'A'*

END PAGE ONE

EX-105

REG 68

*cc: 157-23577-78*

Deleted Copy Sent Douglas Porter  
 by Letter 9/4/73 oil  
 Per FOIA Request oil

52 DEC 12 1972



SD 157-2815

PAGE TWO

HOWARD BARRY GODFREY

INFORMANT

MARTINELLI HAD TESTIFIED IN AN EFFORT TO IMPEACH GODFREY.

TRIAL OF CALVIN HEWDELL FOX FOR PERJURY IN YAKOPEC

TRIAL IS UNDERWAY IN SAN DIEGO.

END

MR. TRANKOR  
ROOM 712-A 9&D

CASE SUGGESTION WRITE-UP

SECRET ARMY ORGANIZATION (SAO)  
EXTREMIST MATTERS  
SEfile 157-1967  
BUfile 157-23577

INSPECTOR JOSEPH H. TRIMBACH: This is a pending case opened  
2/8/72, assigned to SA SIDNEY  
E. RUBIN and supervised by SA F. A. WADDINGTON, JR., Squad #3.

Based upon informant information, the San Diego  
Division, by airtel dated 4/11/72, requested Seattle to deter-  
mine the nature and size of a group operated by one CYRIL  
SUMNER ANDERSON and its affiliation with the SAO in Seattle.  
Further, Seattle was requested to identify an apparent associate  
of ANDERSON, one (FNU) BAGWELL, an alleged member of the SAO.

The San Diego Division requested the investigation  
by Seattle based upon Bureau airtel dated 3/30/72, instructing  
that because of plans then being made by the SAO involving  
possible disruption at the 1972 Republican National Convention  
in San Diego, extremist informants and sources were to be  
targeted toward identifying all members and leaders of the SAO  
and to determine details of any plans to actually disrupt the  
convention.

157-23577-

ANDERSON was already being investigated by Seattle in  
connection with captioned matter. On 4/21/72 and 5/17/72,  
investigation by Seattle determined from ATFD that (FNU)  
BAGWELL was probably identical to HUGHES ANDERSON BAGLEY, JR.,  
a close associate of ANDERSON. The information regarding  
BAGLEY and an LIM regarding ANDERSON were forwarded to the  
Bureau by Seattle letter dated 6/15/72. Seattle advised the  
Bureau that further investigation was being conducted to further  
identify BAGLEY. A review of the file reveals only a paucity  
of investigation has been conducted to further identify BAGLEY,  
and in fact, the file fails to reveal that Seattle Office  
indices were checked regarding BAGLEY. References believed to  
be identical to BAGLEY were contained in Seattle file 174-351  
concerning a series of bombings in Seattle during 1969-1970.

NOT RECORDED

SEATTLE INSPECTION  
9/27/72  
NSI:bfr

16 DEC 5 1972

70 DEC

7 1972

270

It is suggested that:

- 1) A complete review of Seattle indices be conducted regarding BAGLEY.
- 2) Obtain complete identification data and physical description from ATFD who arrested BAGLEY on a weapons charge.
- 3) That BAGLEY's arrest record be obtained under FBI #430 641 H.
- 4) Determine extent of BAGLEY's involvement in the SAO and his association with ANDERSON.
- 5) Determine current residence and location of BAGLEY and interview him per Manual of Instructions Volume IV, Section 122, pages 2 and 3.
- 6) Furnish the Bureau and interested offices results of your findings.

These suggestions are not intended to be all inclusive and you must conduct complete and thorough investigation to resolve the identity and activities of BAGLEY. Should these objectives be achieved either directly or indirectly as a result of these suggestions, advise the Bureau by routing slip, Attn Inspection Division.

Comments of SA SIDNEY E. RUBIN, Supervisor F. A. WADDINGTON, JR., and SAC requested.

*Ein* SIDNEY E. RUBIN:  
9/27/72 SER:rlg

The Inspector's comments have been noted and his instructions will be closely followed.

*J* Supervisor F.A. WADDINGTON, JR.:  
9/27/72 FAW:rlg

The inspector's suggestions are well founded and his instructions will be followed.

SAC *J* J. HILMES:  
9/27/72 JEM:rlg

I concur.

FEDERAL BUREAU OF INVESTIGATION  
COMMUNICATIONS SECTION

DEC 02 1972

TELETYPE

NR 03-SD PLAIN

1:25 AM 12-1-72 NITEL KDV SENT 12/2/72 JEH

TO: ACTING ASSOCIATE DIRECTOR, FBI (157-23577) (ATTN: DID)

FROM: SAC, SAN DIEGO (157-2815)

SECRET ARMY ORGANIZATION (SAO)

EXTREMIST MATTERS

Mr. Felt	_____
Mr. Baker	_____
Mr. Bishop	_____
Mr. Callahan	_____
Mr. Cleveland	_____
Mr. Conrad	_____
Mr. Dalbey	_____
Mr. Gehhardt	_____
Mr. Jenkins	_____
Mr. Marshall	_____
Mr. Miller, E.S.	_____
Mr. Purvis	_____
Mr. Soyars	_____
Mr. Walters	_____
Tele. Room	_____
Mr. Kinlev	_____
Mr. Armstrong	_____
Ms. Herwig	_____
Mrs. Neenan	_____

*G. J. ...*

RE SAN DIEGO NITEL NOVEMBER SIXTEEN LAST.

ON NOVEMBER THIRTY LAST, INVESTIGATOR LAWRENCE WILSON, SAN DIEGO COUNTY DISTRICT ATTORNEY'S OFFICE, SAN DIEGO, CALIFORNIA, ADVISED THAT ON NOVEMBER TWENTY NINE LAST, SAN DIEGO COUNTY SUPERIOR COURT JUDGE ROBERT W. CONYERS SENTENCED HOWARD E. CLARK, ONE ZERO EIGHT ZERO DASH SIXTH STREET, RAMONA, CALIFORNIA TO THREE YEARS PROBATION AND A FINE OF ONE THOUSAND DOLLARS FOR POSSESSION OF ILLEGAL TRACER AMMUNITION. CLARK HAD ENTERED A PLEA OF GUILTY TO THE CHARGE.

REC-32

157-23577-77 5-M...

*F. J. ...*

ON DECEMBER FIRST INSTANT, WILSON ADVISED THAT THE SAN DIEGO COUNTY SUPERIOR COURT JURY TODAY RETURNED A VERDICT OF GUILTY ON ALL COUNTS AGAINST GEORGE MITCHELL HOOVER, WHO WAS TRIED FOR THE SHOOTING OF ONE PAULA THARP IN THE HOME OF RADICAL PROFESSOR PETER BOUMER AND FOR POSSESSION OF A BILLY CLUB.

DEC 5 1972

Calif.

CLARK AND HOOVER ARE TWO OF THE NINE MEN ARRESTED AS A RESULT OF INFORMATION FURNISHED BY HOWARD BARRY GODFREY, INFORMANT

*FBI ...*

IN CONNECTION WITH INVESTIGATION OF THE SECRET ARMY ORGANIZATION AND RELATED EVENTS. P.

*Almon ...*

E M D

34 DEC 4 1972

ROOM 712-K

Deleted Copy Sent by Letter Douglas Porter

TMT FBI SOG

airtel

11/30/72

To: SAC, San Diego (157-2815)

From: For the Acting Director, FBI (157-23577)  
W. Mark Felt  
Acting Associate Director

1 - J. L. Williamson  
1 - C. A. Mosher

SECRET ARMY ORGANIZATION (SAO)  
EXTREMIST MATTERS

ReSDtel 11/21/72.

A copy of referenced teletype was furnished Deputy Assistant Attorney General Kevin T. Maroney on 11/22/72. The action being taken to clarify type of information defense may request of former Special Agent (SA) Christensen and SA Petersen is correct, particularly regarding records of the FBI. Keep FBIHQ advised of developments.

CAM:aso (5) <sup>aso</sup>

EX-117

REC-88

157-23577

NOTE:

Referenced teletype indicated former SA Steven L. Christensen and SA Earl M. Petersen, San Diego, were subpoenaed by defense to appear in trial of SAO leader Jerry Lynn Davis in Superior Court, San Diego County, San Diego, California. SA Petersen served with subpoena duces tecum to produce all FBI and personal records pertaining to Jerry Lynn Davis and contacts with Howard Barry Godfrey, former FBI informant. Efforts by U. S. Attorney and District Attorney, San Diego County, are being made to have the subpoena quashed so that former SA Christensen will not testify and that FBI records will not be requested.

MAILED 4

19 DEC 1 1972

NOV 26 1972

Jerry Lynn Davis, head of the paramilitary, anticommunist, white extremist SAO, has been indicted for illegal possession of explosives and his trial is to start 1/15/73 in Superior Court, San Diego County, San Diego, California. Basis for charges against Davis is information supplied by former FBI informant Howard Barry Godfrey. This matter was coordinated with James L. Williamson, Office of Legal Counsel, and Deputy Assistant Attorney General Kevin T. Maroney.

- \_\_\_ alt
- \_\_\_ Baker
- \_\_\_ Bishop
- \_\_\_ Callahan
- \_\_\_ Cleveland
- \_\_\_ Conrad
- \_\_\_ Dalbey
- \_\_\_ DeLoach
- \_\_\_ Jenkins
- \_\_\_ Marshall
- \_\_\_ Miller, E.S.
- \_\_\_ Purvis
- \_\_\_ Soyars
- \_\_\_ Walters
- \_\_\_ Tele. Room
- \_\_\_ Mr. Kinley
- \_\_\_ Mr. Armstrong
- \_\_\_ Mr. Hoover

*Handwritten signatures and initials: EM, CC, M/ey, D, A*

Domestic Intelligence Division

INFORMATIVE NOTE

Date 11/22/72

Jerry Lynn Davis head of the para-military anticommunist white extremist Secret Army Organization has been indicted for illegal possession of explosives. Trial to start 1/15/73 in Superior Court, San Diego County, San Diego, California. Charges against Davis based on information supplied by former FBI informant Howard Barry Godfrey.

Attached indicates defense has subpoenaed former Special Agent Steven L. Christensen and Special Agent Earl M. Petersen, San Diego Office. Petersen served with subpoena duces tecum requesting production of all FBI and personal records pertaining to Davis and the Secret Army Organization and contacts with informant Godfrey.

This matter being coordinated with Office of Legal Counsel and it will be discussed with Deputy Assistant Attorney General Kevin T. Maroney. San Diego to be advised of decision regarding testimony and production of records.

WCP:bak

*WCP*

*WCP EM/GCM*

*GCM*

*[Handwritten signature]*

*Recommendations of AUSA Deaton should be followed. JLM*

FEDERAL BUREAU OF INVESTIGATION  
COMMUNICATIONS SECTION

NOV 23 1972

Mr. Felt	_____
Mr. Bates	_____
Mr. Bishop	_____
Mr. Callahan	_____
Mr. Cleveland	_____
Mr. Conrad	_____
Mr. Dalbey	_____
Mr. Gebhardt	_____
Mr. Jenkins	_____
Mr. Marshall	_____
Mr. Miller	_____
Mr. Poyas	_____
Mr. Soyars	_____
Mr. Walters	_____
Tele. Room	_____
Mr. Kinloy	_____
Mr. Armstrong	_____
Ms. Herwig	_____
Mrs. Neenan	_____

NR 05 SD PLAIN

11:35 PM NITEL 11-21-72 GKF

TO ACTING DIRECTOR (157-23577) (ATTN: D. I. D.)

FROM SAN DIEGO (157-2815) 4P

SECRET ARMY ORGANIZATION (SAO)  
EXTREMIST MATTERS.

RE SAN DIEGO NITEL NOVEMBER SIXTEEN LAST.

ON NOVEMBER SIXTEEN LAST, FORMER SA STEVEN L. CHRISTENSEN WAS SERVED WITH A SUBPOENA BY THE DEFENSE FOR TESTIMONY IN THE JERRY LYNN DAVIS CASE BEGINNING JANUARY FIFTEEN NEXT. DAVIS IS CHARGED WITH POSSESSION OF EXPLOSIVES AS A RESULT OF INFORMATION MADE AVAILABLE BY FORMER FBI INFORMANT HOWARD BARRY GODFREY. HE IS BEING TRIED IN THE SAN DIEGO COUNTY SUPERIOR COURT.

SA EARL M. PETERSEN WAS SERVED WITH A SUBPOENA DUCES TECUM ON NOVEMBER SIXTEENTH LAST FOR HIS APPEARANCE AS A WITNESS FOR THE DEFENSE AND FOR PRODUCTION OF ALL FBI AND PERSONAL RECORDS PERTAINING TO JERRY LYNN DAVIS, THE SECRET ARMY ORGANIZATION AND CONTACTS WITH HOWARD BARRY GODFREY.

SA PETERSEN HAS BEEN SUBPOENED BY THE PROSECUTION PREVIOUSLY AND LIST OF QUESTIONS TO BE ASKED BY THE PROSECUTION ARE THE SAME AS THOSE PREVIOUSLY ASKED OF SA PETERSEN WHEN HE APPEARED BEFORE THE SAN DIEGO COUNTY GRAND JURY ON JULY NINETEEN LAST.

END PAGE ONE  
51 DEC 1972

*G. L. V.*  
*W. P. [unclear]*

*e. h. [unclear]*  
*d. l.*

*file*  
*157-23577*

NOV 23 1972

REC-71  
EX-103  
SEC.

PAGE TWO

SD 157-2815

LETTER TO ACTING DIRECTOR, FBI DATE SEPTEMBER FIVE LAST STATED ON SEPTEMBER FIRST LAST, KEVIN T. MARONEY, DEPUTY ASSISTANT ATTORNEY GENERAL, INTERNAL SECURITY DIVISION ADVISED SPECIAL AGENT WILLIAM C. PATTERSON THAT AUTHORITY WAS GRANTED FOR SA PETERSEN TO TESTIFY FOR THE PROSECUTION IN SUPERIOR COURT, SAN DIEGO COUNTY, SAN DIEGO, CALIF., IN THE TRIAL OF JERRY LYNN DAVIS. SA PETERSEN'S TESTIMONY WILL CONCERN HIS RELATIONSHIP WITH FORMER BUREAU INFORMANT GODFREY AND RECEIPT OF INFORMATION FROM HIM REGARDING DAVIS' POSSESSION OF EXPLOSIVES.

DEPUTY DISTRICT ATTORNEY FRANK SEXTON, SAN DIEGO COUNTY, ON NOVEMBER TWENTY FIRST INSTANT ADVISED THAT HE INTENDS TO CONTACT FREDERICK HETTER, DEFENSE ATTORNEY FOR JERRY LYNN DAVIS, TO SEE IF HE WILL CONSIDER DROPPING THE SUBPOENA FOR CHRISTENSEN. HE INTENDS TO POINT OUT TO HETTER THAT ALL EXPENSES OF BRINGING CHRISTENSEN TO SAN DIEGO TO TESTIFY WILL BE PAID BY THE DEFENSE AND THAT TESTIMONY BY CHRISTENSEN WILL BE OF LITTLE VALUE TO THE DEFENSE.

ASSISTANT UNITED STATES ATTORNEY SHELDON DEUTSCH, ON NOVEMBER

END PAGE TWO



PAGE THREE

SD 157-2815

TWENTY FIRST INSTANT ADVISED THAT HE RECOMMENDS THAT FORMER SA CHRISTENSEN AND SA PETERSEN ANSWER NO QUESTIONS ON DIRECT EXAMINATION BY THE DEFENSE UNLESS SUCH QUESTIONS ARE PREVIOUSLY APPROVED BY THE ATTORNEY GENERAL OF THE UNITED STATES. HE HAS DIRECTED A LETTER TO ATTORNEY HETTER POINTING OUT THAT ANY QUESTIONS TO BE ASKED OF CHRISTENSEN AND PETERSEN SHOULD BE FURNISHED TO THE OFFICE OF THE UNITED STATES ATTORNEY PRIOR TO THE DATE OF THE TRIAL IN ORDER THAT THE APPROVAL TO ANSWER THE QUESTIONS CAN BE OBTAINED. HE ALSO POINTED OUT IN HIS LETTER THAT THE SUBPOENA DUCES TECUM REQUESTING PETERSEN TO PRODUCE RECORDS WAS TOO BROAD AND WILL NOT BE APPROVED BY THE ATTORNEY GENERAL. HE SUGGESTS THAT ATTORNEY HETTER MIGHT WISH TO BE MORE SPECIFIC IN HIS REQUEST IN ORDER THAT THE REQUEST CAN BE SUBMITTED FOR APPROVAL. A COPY OF THIS LETTER IS BEING DIRECTED BY AUSA DEUTSCH TO DEPUTY ASSISTANT ATTORNEY GENERAL MARONEY. AUSA DEUTSCH STATED THAT IN HIS OPINION THE FBI SHOULD PRODUCE NO RECORDS OR WRITTEN MATERIAL IN THIS TRIAL. HE NOTED THAT ATTORNEY HETTER WAS THE ATTORNEY FOR THE DEFENDANT

END PAGE THREE

PAGE FOUR

SD 157-2815

WILLIAM FRANCIS YAKOPEC IN A TRIAL JUST CONCLUDED IN WHICH THE GOVERNMENT REFUSED TO PRODUCE RECORDS AND FOR THIS REASON HE IS AWARE THAT THEY WILL PROBABLY NOT BE PRODUCED IN THIS CASE.

AUSA JOHN R. NEECE WAS PRESENT WITH AUSA DEUTSCH WHILE THE TESTIMONY IN THE DAVIS TRIAL WAS BEING DISCUSSED. NEECE POINTED OUT THAT A MOTION TO SUPPRESS THE SUBPOENA DECES TECUM COULD BE MADE IN ADVANCE OF THE TRIAL. IT WAS DECIDED THAT THIS WOULD NOT BE NECESSARY INASMUCH AS THE PROCEDURE FOR NOT PRODUCING THE RECORDS UNDER U. S. TITLE TWENTY EIGHT, SECTION SIXTEEN POINT TWELVE SHOULD SUFFICE.

*Code of Federal Regulations*

SAN DIEGO HAS NO INFORMATION AT THIS TIME TO INDICATE WHAT QUESTIONS THE DEFENSE WOULD ASK OF CHRISTENSEN AND PETERSEN.

SAN DIEGO RECOMMENDS THAT CHRISTENSEN AND PETERSEN TESTIFY ON DIRECT EXAMINATION BY THE DEFENSE ONLY TO QUESTIONS PREVIOUSLY APPROVED BY THE ATTORNEY GENERAL AND THAT NO WRITTEN RECORDS BE PRODUCED IN THE DAVIS TRIAL.

END

TMT FBI SOG CLR

CC ROOM 712-A D&D

Assistant Attorney General  
Internal Security Division

November 22, 1972

For the Acting Director, FBI  
W. Mark Felt  
Acting Associate Director

1 - Mr. D. J. Dalbey  
1 - Mr. W. C. Patterson

SECRET ARMY ORGANIZATION  
EXTREMIST MATTERS

This is to confirm that on November 20, 1972, Kevin T. Maroney, Deputy Assistant Attorney General, Internal Security Division, advised Special Agents William C. Patterson and Charles A. Mosher that authority was granted for Special Agent Arthur J. Hooper to testify in Superior Court, San Diego County, San Diego, California, in the trial of Calvin Hendell Fox, which is to begin December 5, 1972.

Fox, a member of the white extremist Secret Army Organization (SAO), testified on September 13, 1972, during the trial of another SAO member, William Francis Yakopec, that the FBI on May 18, 1972, planted in his business files a letter from the SAO indicating acceptance of Fox as an SAO member. As a result of his testimony in the Yakopec trial, Fox has been indicted for perjury.

EX-117 118-70 157-23577-74

Mr. Maroney on September 21, 1972, authorized Special Agent Hooper to testify in the trial of Yakopec after he had reviewed the proposed testimony of Special Agent Hooper which refuted Fox's allegation. Mr. Maroney was advised that Special Agent Hooper's testimony during the trial of Fox was to be identical to that given in the Yakopec trial. Mr. Maroney authorized Special Agent Hooper's testimony in line with the proposed testimony as described above. If Special Agent Hooper is questioned concerning other than as discussed, he is to advise that in accordance with Code of Federal Regulations, Title 28, Section 16.12, such information acquired while in the performance of official duties as a Special Agent of the FBI cannot be disclosed unless approved by the Attorney General. Additional information required is to be identified and furnished the Department in order that consideration can be given as to whether such information is to be disclosed.

157-23577  
WCP:aso (5)

SEE NOTE PAGE TWO

- Felt \_\_\_\_\_
- Baker \_\_\_\_\_
- Bishop \_\_\_\_\_
- Callahan \_\_\_\_\_
- Cleveland \_\_\_\_\_
- Conrad \_\_\_\_\_
- Dalbey \_\_\_\_\_
- Gebhardt \_\_\_\_\_
- Jenkins \_\_\_\_\_
- Marshall \_\_\_\_\_
- Miller, E.S. \_\_\_\_\_
- Purvis \_\_\_\_\_
- Soyars \_\_\_\_\_
- Walters \_\_\_\_\_
- Tele. Room \_\_\_\_\_
- Kinley \_\_\_\_\_
- Amstrong \_\_\_\_\_
- Ierwig \_\_\_\_\_

MAH ROOM 117 TELETYPE UNIT NOV 28 1972

Assistant Attorney General  
Internal Security Division

NOTE:

Calvin Hendell Fox in May, 1972, was identified by former Bureau informant Howard Barry Godfrey as one of the most rabid and violent new members of the paramilitary, ultraconservative, anti-communist SAO. Godfrey furnished information that soon after the attempted assassination of Presidential candidate George Wallace, Fox indicated he was going to Washington, D. C., to do some demonstrating of his own. Investigation to develop background information and the license number of Fox's automobile resulted in SA Arthur J. Hooper and former SA Steven L. Christensen making inquiry at Fox's service station where an employee of Fox's looked through Fox's file cabinet in a futile attempt to find the license number of Fox's automobile. As indicated above, Fox, during testimony in the trial of William Francis Yakopec, alleged the FBI had planted a document in his personal files on 5/18/72. Fox, because of his testimony, has been indicted for perjury. Testimony by SA Hooper, during the Yakopec trial, and testimony by Fox's former employee, Gregory L. Pitman, refuted Fox's allegation. This matter has been coordinated with SA James L. Williams of the Office of Legal Counsel.

Domestic Intelligence Division

INFORMATIVE NOTE

Date 11/20/72

Calvin Hendell Fox, a member of the white extremist Secret Army Organization (SAO), testified 5/18/72 during trial in Superior Court, San Diego County, San Diego, California, of William Francis Yakopec, another SAO member, the FBI planted in his personal files a letter from the SAO accepting him as a member. Fox has subsequently been indicted for perjury for denying being an SAO member and for alleging the FBI planted material in his personal files. Trial to commence 12/5/72. Departmental approval previously obtained dealing with Yakopec trial regarding testimony by Special Agent Arthur J. Hooper.

Attached indicates SA Arthur J. Hooper to receive subpoena to testify in trial of Fox for prosecution. Testimony to be identical to that given during trial of Yakopec.

This matter being coordinated with Office of Legal Counsel and will be discussed with Deputy Assistant Attorney General Kevin T. Maroney, Internal Security Division. San Diego will be advised of decision regarding testimony.

WCP:was

*wcp*

*EM/DA*

*GCM*  
*WKC* *DA*

FEDERAL BUREAU OF INVESTIGATION  
COMMUNICATIONS SECTION

NOV 18 1972

NR 06 SD CODE

1045 PM 11-17-72 NITEL KDV

TELETYPE

TO: ACTING DIRECTOR (ATTN: DID) (157-23577)

FROM: SAN DIEGO (157-2815)

SECRET ARMY ORGANIZATION (SAO)

EXTREMIST MATTERS

*Night teletype*

RE SAN DIEGO NITEL NOVEMBER SIXTEEN LAST AND SAN DIEGO  
AIRTEL TO BUREAU NOVEMBER SEVENTEEN INSTANT CAPTIONED CALVIN  
HENDELL FOX, EM DASH SAO.

INVESTIGATOR LARRY WILSON, SAN DIEGO COUNTY DISTRICT ATTORNEY'S  
OFFICE, ADVISED ON NOVEMBER SEVENTEEN INSTANT THAT SA ARTHUR J.  
HOOPER WILL RECEIVE A SUBPOENA TO TESTIFY IN THE TRIAL OF CALVIN  
HENDELL FOX, SAO MEMBER, BEGINNING ON DECEMBER FIFTH NEXT. SA  
HOOPER WILL BE ASKED QUESTIONS IDENTICAL TO THOSE ASKED HIM IN  
THE TRIAL OF WILLIAM FRANCIS YAKOPEC RECENTLY CONCLUDED. HE  
WILL BE SUBJECT TO CROSS EXAMINATION BY THE DEFENSE  
ASSISTANT UNITED STATES ATTORNEY  
AUSA JOHN R. NEECE, SAN DIEGO, HAS BEEN ADVISED THAT SA HOOPER  
WILL RECEIVE SUBPOENA TO TESTIFY. A REPRESENTATIVE OF THE USA  
WILL BE PRESENT DURING TESTIMONY BY SA HOOPER.

INASMUCH AS THE QUESTIONS TO BE ASKED OF SA HOOPER BY THE  
PROSECUTION ARE IDENTICAL TO THOSE APPROVED FOR HIS TESTIMONY IN  
THE YAKOPEC TRIAL, <sup>Unless forced to Confess to the Bureau</sup> SA HOOPER WILL TESTIFY IN THE FOX TRIAL.

FOX IS CHARGED WITH PERJURY AS A RESULT OF TESTIMONY IN THE

END PAGE ONE

NOV 30 1972

Mr. Felt	_____
Mr. Mohr	_____
Mr. Bishop	_____
Mr. Callahan	_____
Mr. Cleveland	_____
Mr. Conrad	_____
Mr. Dalbey	_____
Mr. Galt	_____
Mr. Jenkins	_____
Mr. Ladd	_____
Mr. Nichols	_____
Mr. Rosen	_____
Mr. Soyars	_____
Mr. Walters	_____
Tele. Room	_____
Mr. Kinley	_____
Mr. Armstrong	_____
Ms. Harwig	_____
Mr. Neenan	_____

*G. Lyons*  
*w. l. [unclear]*

REC-69

ST. 101

United States Attorney

NOV 22 1972

PAGE TWO

SD 157-2815

YAKOPEC TRIAL IN WHICH HE TESTIFIED THAT HE WAS NOT A MEMBER OF  
THE SAO AND THAT THE FBI HAD PLANTED EVIDENCE OF HIS MEMBERSHIP  
IN HIS FILES.

E N D

HOLD

cc MR. TRAINOR  
ROOM 712-A 9&D

CODE

TELETYPE

NITEL

TO SAC SAN DIEGO

11/20/72

FROM ACTING DIRECTOR FBI (157-23577)

1 - Mr. Dalbey  
(Mr. J. L. Williamson)

SECRET ARMY ORGANIZATION (SAO), EXTREMIST MATTERS.

RESDTL NOVEMBER EIGHTEEN LAST.

1 - Mr. W. C. Patterson

KEVIN T. MARONEY, DEPUTY ASSISTANT ATTORNEY GENERAL, INTERNAL SECURITY DIVISION, DEPARTMENT OF JUSTICE, ON NOVEMBER TWENTY INSTANT ADVISED AUTHORITY WAS GRANTED FOR SA ARTHUR J. HOOPER TO TESTIFY DECEMBER FIVE NEXT DURING TRIAL OF CALVIN HENDELL FOX IN SUPERIOR COURT, SAN DIEGO COUNTY, SAN DIEGO, CALIFORNIA. TESTIMONY IS TO BE IN LINE WITH PROPOSED QUESTIONS AND ANSWERS AS SET FORTH IN SAN DIEGO TELETYPE SEPTEMBER TWENTY LAST AND IN ACCORDANCE WITH THE INSTRUCTIONS REGARDING TESTIMONY AS SET FORTH IN BUREAU TELETYPE SEPTEMBER TWENTY-ONE LAST.

UNRECORDED COPY FILED IN 157-23577-71

SI-113

REC-14

157-23577-71

- 1 - 157-2033 (Calvin Hendell Fox)
- 1 - Personnel File of SA Arthur J. Hooper

NOV 21 1972

WCP:aso (6) asd

NOTE:

Calvin Hendell Fox was a member of the SAO, a paramilitary anticommunist, white extremist group. Investigation of Fox institut May, 1972, as he hurriedly departed for Washington, D. C., and it wa feared he intended harm to either high Government officials or to th assailant of Presidential candidate Governor George Wallace. Fox ha been indicted for denying that he was an SAO member and for claiming the FBI planted a document in his personal files on 5/18/72. These allegations against Bureau made during testimony by Fox at trial of

5 NOV 23 1972

NOTE CONTINUED PAGE TWO

MAIL ROOM  TELETYPE UNIT

COPY/CP



TELETYPE TO SAN DIEGO  
RE: SECRET ARMY ORGANIZATION (SAO)  
157-23577

NOTE. CONTINUED:

another SAO member, William Francis Yakopec. SA Arthur J. Hooper of San Diego testified during trial of Yakopec to refute allegation by Fox with Departmental approval. San Diego teletype 9/20/72 set forth proposed questions and answers regarding SA Hooper's testimony in the Yakopec trial. Bureau teletype 9/21/72 set forth limitations regarding testimony of SA Hooper and instructions regarding action if additional information required. This matter has been coordinated with SA James L. Williamson, Office of Legal Counsel. SAs William C. Patterson and Charles A. Mosher conferred with Kevin T. Maroney, Deputy Assistant Attorney General, Internal Security Division, on 11/20/72.

SSC Request 1/20/76  
Item 3 (Re: Secret Army Organization)  
Volume IV

Access

UNITED STATES GOVERNMENT

# Memorandum

TO : SAC, SAN DIEGO (157-2815)      DATE: 12/4/75

FROM : SUPV. ANTHONY J. MALONEY, JR.

SUBJECT: SECRET ARMY ORGANIZATION (SAO)  
EM - SAO

At 10:15 AM, on 12/4/75, MILTON VIORST telephonically self-described himself as a free-lance writer for a literary publication known as the New York Review, who is stationed in Washington, D.C. and who is temporarily staying at the Mission Valley Inn, Room 359, San Diego, telephone 298-8281.

VIORST volunteered that he is aware of the provisions of the Freedom of Information Act and he does not feel they apply to the purpose of his call. VIORST said he is interested in doing a "Human Interest" magazine article on the SAO and in connection therewith requested authorization to interview SAs PETERSEN and NAYLOR concerning the SAO.

VIORST is aware there is a civil suit pending against some Agents in the San Diego Division as a result of the SAO and said he would try to refrain from asking any questions which might tend to prejudice the Agents' rights in the civil suit.

VIORST was courteously informed that circumstances caused his request to be denied.

On 12/4/75, the above facts were telephonically furnished for informational purposes only to Mr. PERKS of the External Affairs Division at the Bureau and who agreed with the decision and felt no correspondence was necessary to the Bureau in this matter.

3 - San Diego

AJM:ejt  
*(Handwritten initials)*

#5      157-2815-431

SEARCHED _____	INDEXED _____
SERIALIZED _____	FILED _____
DEC 4 1975	
FBI - SAN DIEGO	

*(Handwritten initials)*

*Petersen*  
*Naylor*



Date prepared

2/11/75

Date received

4/7/75

Received from (name or symbol number)

INFORMANT

Received by

SA Earl M. Peterson

Method of delivery (check appropriate blocks)

in person  by telephone  by mail  orally  recording device  written by Informant

Orally furnished and reduced to writing by Agent: Date

Date of Report

2/11/75

Dictated \_\_\_\_\_ to \_\_\_\_\_

Date(s) of activity

1/17/75

Transcribed \_\_\_\_\_

1/31/75

Authenticated by informant 2/1/75

Description of activity or material

Informant Ron Eddy & George Mitchell  
Horn

File where original is located if not attached

170-512A

\* INDIVIDUALS DESIGNATED BY AN ASTERISK (\*) ONLY ATTENDED A MEETING AND DID NOT ACTIVELY PARTICIPATE. VIOLENCE OR REVOLUTIONARY ACTIVITIES WERE NOT DISCUSSED.

Information recorded on a card index by \_\_\_\_\_ on date \_\_\_\_\_

Remarks:

- 1-170-512A - 366
- 1-157-152 (Ron Eddy)
- 1-157-3487 (Dennis Low)
- 1-157-2898 (Thomas F. Knight)
- 1-157-2610 (Mickey Wakefield)
- 1-157-2545 (Ray Wilson)
- 1-157-201 (Herald Smith)
- 1-170-286 (Hodfrey)
- 1-157-3087 (Joe Orin)
- 1-157-4557 (Tom Metzger)
- 1-157-4547 (WCC)
- 1-157-3017 (George Horn)
- 1-157-2815 (SAO)

EM P: ef

(13)

Block Stamp

157-2815-425

SEARCHED	INDEXED
SERIALIZED	FILED
FEB 11 1975	
FBI - SMO (RAC)	

February 1, 1975

SUBJECT: Ron Eddy; George Mitchell Hoover.

It has been ascertained that at this time Ron Eddy of Poway is not interested in trying to form or lead any type of security force for any right-wing extremist group. When asked by James K. Warner of Los Angeles (via Dennis Loso of Escondido) if he would do this, Eddy stated that he would like to see the formation of a Security Force with teeth in it but does not consider himself to be enough of a leader to do it himself.

While declining to lead a Security Force, Eddy did say that the only way to stop FBI infiltration of rightist groups would be for one of the infiltrators to "wind up in the river" someday. Eddy is positive that Tom Knight's San Diego unit of the Nazi Party has a regular FBI infiltrator. The only three men of whom he is not suspicious are Mickey Wakefield, Ray Wilson and Gerald Smith. Said Eddy, "Those three men dropped out of the thing and so I figure they're okay but you can bet that the fink is still in there pushing".

Loso said that the whereabouts of people like Barry Godfrey should be learned and they should be telephoned and intimidated. Eddy said he thinks such intimidations would be a waste of time and that people like Godfrey should be killed. Mickey Wakefield of San Marcos went along with Eddy's suggestion. Ron Eddy also mentioned having had an encounter with an FBI agent named Peterson in San Diego but did not elaborate.

Eddy firmly believes that any man who commits himself to one organization in the Far Right should not be involved with others. He says he would be very suspicious of anyone who is. He is also somewhat suspicious of Tom Knight. He says that Joe Brinker gave Knight the name of a man interested in Nazism and two weeks later the FBI interviewed the man. Also, Eddy wonders how Knight saved his federal job in the face of his continued Nazi activities. Eddy feels that any regular rightist extremist who stays on with the Nazi Party now must warrant heavy suspicion of being an FBI informant.

On Friday night, January 31, 1975 Ron Eddy met Tom Metzger of Fallbrook for the first time. Metzger showed Eddy some pictures and slides of New Christian Crusade activities and the two seemed to hit it off pretty well. Metzger told Eddy, Wakefield and Loso of a visit he received at his home on January 17, 1975 from agents of the Internal Security Section. He said the agents were nervous.

George Mitchell Hoover

Here is one last bit of information. The New Christian Crusade people are very concerned about the imprisonment of George Hoover of the Secret Army Organization. At one of their banquets the NCC had four unoccupied places set at the table which were in honor of four men whom they hold to be absent heroes. These four men were Joe McCarthy, George Hoover, Charles Lindbergh and a man named R. Miles.

Anyway, it has been learned that a man whom Tom Metzger knows is going to take a dossier of the Hoover case to some congressman in Washington, D.C. who is part of a committee currently scheduled to investigate the FBI. The dossier consists of newspaper clippings and other material pertaining to Hoover's activities in the SAO, his arrest, conviction, appeal, etc. They are hoping to stir up a big publicity stink to give the FBI a bad name due to Barry Godfrey's activities and in so doing hope to effect an eventual release of Hoover from prison. By the way, the NCC people do not refer to Hoover by his correct name. For some reason they all call him Mickey Hoover. That is about all for now. I hope this will be of some help to you.

INFORMANT

Date prepared

12/26/74

Date received

12/12/74

Received from (name or symbol number)

INFORMANT

Received by

SA Earl M. Peterson

Method of delivery (check appropriate blocks)

in person

by telephone

by mail

orally

recording device

written by Informant

If orally furnished and reduced to writing by Agent:

Date

Dictated

to

Transcribed

Authenticated by Informant

12/9/74

Date of Report

12/9/74

Date(s) of activity

12/8/74

Brief description of activity or material

NCC picketing at border 12/8/74

File where original is located if not attached

170-512A

\* INDIVIDUALS DESIGNATED BY AN ASTERISK (\*) ONLY ATTENDED A MEETING AND DID NOT ACTIVELY PARTICIPATE. VIOLENCE OR REVOLUTIONARY ACTIVITIES WERE NOT DISCUSSED.

Information recorded on a card index by

on date

Remarks:

1-170-512A-350

1-157-4547 (NCC)

1-157-4557 (Tom Metzger)

2- Los Angeles (Rich Norton) (RM)

1-157-3138 (Vic Walton)

1-157-2521 (Bill Miller)

1-157-28 (NSWOB)

1-157-1254 (Tax Rebellion Committee)

1-157-3220 (National States Rights Party)

1-157-4168 (MCC)

①-157-2815 (SAO)

1-157-3498 (Wesley Burdett)

EMB:cf

(13)

Further dissemination left to receiving offices.

Block Stamp

157-2815-424

SEARCHED \_\_\_\_\_ INDEXED \_\_\_\_\_  
SERIALIZED 1 FILED \_\_\_\_\_

DEC 30 1974

FBI-SAN DIEGO

SUBJECTS: NCC picket border; thoughts on NCC; Weapons.

Here is some more information regarding the National Christian Crusade picket which took place at the U.S.-Mexico border in San Ysidro on December 8, 1974. Of the 16 men who took part in this uniformed picket, 10 were from the San Diego area and 6 were from Los Angeles. It was mistakenly stated in yesterday's report on this demonstration that 10 of the men were identified. In reality, 11 were fully identified, 1 partially identified, and 4 unidentified. The 4 unidentified were all from L.A.

Also, the members of this picket were divided into two contingents, Los Angeles and San Diego. Commanding the San Diego group was Tom Metzger of Fallbrook and in charge of the L.A. men was Rick Norton. Also, Norton was in overall command of the operation.

Two other things which were not mentioned in the earlier report are as follows. First, Norton told his men that if attacked, they should form into a back to back square and "let her rip". Also, after the conclusion of the demonstration, Norton conducted a very brief prayer.

As to my thoughts on the NCC, I feel that this group has the potential to command much more support from a broader base of people than most of the right-wing extremist groups. It seems significant to this informant that men like Vic Walton and Bill Miller would actually get up the nerve to take to the streets in uniform, a thing they never did for the Nazi Party although both supported it.

It is also noteworthy that the NCC was able to draw supporters from so many other extremist groups. Taking part in this demonstration were elements from the Nazi Party, the Tax Rebellion Committee, the National States Rights Party, the Ministry of Christ Church and the old Secret Army Organization.

Also, this group does not automatically get adverse responses from the public in the streets. Indeed, many passersby indicated their support for the group's aims in the demonstration of the 8th. The leadership is more intelligent and more approachable than that of groups like the NSWPP or MCC. They more easily establish a good rapport with the public in general and are not so blunt in stating their racism.



Wesley Rounds

It has been learned that Wes Rounds is losing money on his Californian Motel in Escondido. He is seriously considering purchasing a motel in which closed circuit television featuring X-rated movies is present. He says this is a real money maker and he just might be compelled to go that route.

That is all for now.

INFORMANT

3121

SAC (157-~~1223~~)

8/6/74

SA Earl M. Petersen

Jerry Busche

EM-SAO

The attached letter was obtained from Detective Les Oberlies San Diego Police Department, ISU, on 7/19/74.

The letter is self explanatory and indicates that Jerry Busch is furnishing information to the Door. He probably furnished the information that the Door has printed in the past about the Secret Army Organization, Barry Godfrey and the right wing in general.

1 - 170-226 (Godfrey)      Note:  
① - 157-2215 (SAO)  
1 - 160-14948 (Door)  
EMP:emp

*P.D. INFORMANT*

(5)

157-2815-419

SEARCHED	INDEXED
SERIALIZED	FILED
AUG 6 1974	
FBI - SAN DIEGO	

Bellingham, Wn, 98225  
July 5, 1973

Mr. Bill Ritter  
Editor  
The Door  
P.O. Box 2022  
San Diego, Calif. 92112

Dear Bill,

Well, here it is. Please excuse  
the delay, also my wretched handwriting.  
I have, for the time being, been separated  
from my typewriter (a small matter of \$500  
as to the mechanics). There is only one  
item regarding the Gunn Racism, omitted.  
That one I didn't feel safe in putting on  
paper. So here goes the Godfrey thing:

### Godfrey Data

I first saw, but was not introduced to Howard  
Barry Godfrey at the Stardust Motel San  
Diego Gun Show in September, 1969. A  
number of persons, among them Mr. George  
Hoover and myself, were manning the  
N.A.R.B.A. booth at the show. Godfrey  
came frequently to this booth during the  
three days of the show. On these occasions  
he would "walk through the show" with Mr.  
Howard Barry Lynn Davis, holding

the content of the conversations.

In November, 1949 I was asked to go on a "soft penetration" for intelligence gathering purposes, with Godfrey. I was asked to make a report on Godfrey's conduct and ability. Godfrey was introduced to me only as "Barry".

We met at a San Diego tavern, the Arrow Club on El Cajon Blvd. From there we drove to the Lake Elsinore area and visited the home of an elderly gentleman, whose name and supposed importance I have forgotten.

For someone who was supposed to be an "intelligence type", Godfrey impressed me as ill-fitted for the role. He alternately exhibited physical traits or gestures — particularly his eyes and hands — which I would classify as; 1) sly or sneaky, 2) nervousness or cowardice and 3) awareness of personal guilt. All of these, despite the fact we were breaking no laws, doing no harm and in the house at the invitation of its owner.

Following the "interview", we left the

Subj: His house and I covered that we were being followed. Reluctantly - and that's the only way I can describe Godfrey's attitude - he followed my instructions to try to shake our surveyors. Normally, I am fairly competent in breaking a surveillance, but this time it didn't work. Even though we doubled back on the car following us and pulled into a service station, the car was behind us again when we entered the freeway Southbound. Godfrey "panicked" then, increasing his speed and driving directly to San Diego and to a Chinese restaurant where we met his superior, Bill Clay.

In retrospect, wherein we all become geniuses, I can conclude that the surveillance team following us that night consisted of Special Agent Petersen or Christiansen and other FBI storm troopers. That Godfrey's reluctance and panic came from his fear of doing anything counter to his instructions from his employers (the FBI).

3. During the period of November, 1969 to Summer of 1971, Howard Godfrey frequently came to Gunsmoke Ranch on weekends

Shooting were practiced as recreation. On these visits, which were always brief - lasting less than an hour - he would take Mr. Hoover or Mr. Jerry Lynn Davis aside for quiet conversations. During these visits, he would "act" as if he did not know Bill Clay or myself.

It was during this time that I learned he had been appointed "Director of Intelligence" for the San Diego area sector of the Minutemen.

4. In August of 1971, Godfrey came to my apartment and requested I verify addresses and phone numbers for a series of names he had on 3x5 note cards. He then proceeded to try to "recruit" me for "his intelligence network".

5. It was also during June, July or August of 1971 that both Godfrey and Donald Siggretti - posing as "Don Simms" - visited Runsmoke Ranch and, although supposedly "not knowing each other", they spoke together, on at least one occasion, in a manner similar to the conversations Godfrey had previously held with Mr.

Hoover and Mr. Davis

Following these "casual conversations" between two spectators at a shooting match, in October, 1921, Godfrey came up with bizarre ideas to "take care of these Red punks" if the Republican Convention was held in San Diego. Also, a number of us received literature on a new group, the SAO. Mr. Fleury and I were given specific instructions not to involve ourselves in any way with the SAO. Mr. Fleury continued to receive SAO literature (unmasked) although I did not.

Some of Godfrey's ideas included:

1. The use of massive dosages of LSD, cyanide or strychnine introduced into the punch at Anti-war group meetings.
2. Bombing of VVAW headquarters, the Guild Theatre and several porno shops.
3. Bombings of the homes or offices of Anti-war leaders.
4. Kidnaping or assassination of Anti-war leaders and activists.
5. Fire bombing of vehicles and other property belonging to Anti-war activists.

NOTE: Our general attitude toward Godfrey

and his proposals at that time was;  
"He's a fucking nut!"

By November and December of 1971, Godfrey's "ideas" had solidified — along with the decision to hold the Republican Convention in San Diego. His other ideas having been rejected (I have a strong suspicion that some of them were carried out or attempted by Godfrey) he now proposed that someone construct radio controlled, Freeflight model airplanes to carry payloads of HE and white phosphorous, to be flown over Vacation Island and detonated. When Mr. Hoover, Mr. Fleury and I heard of this idea we rejected the possibility out of hand.

Godfrey likewise attempted to involve others in a conspiracy to manufacture a similar aircraft, loaded with TNT or C-4 plastique, to be flown into Air Force 1 as it landed at Lindberg Field or El Toro Marine Air Base at San Clemente. When I heard version of this, I expressed the opinion that Godfrey had lost his mind to ever suggest anything as insane as an attempt on the life of the President. I further stated that if I ever received information that he was actually proceeding, I would report it to the Secret Service.



others, including Mr. Hoover, expressed the same attitude. In retrospect, it appears that those comments must have found their way to Godfrey.

During this time I also learned Godfrey was "San Diego leader" of the S.A.O.

8. In December, 1971, Godfrey attempted to get someone to assassinate Dr. and Mrs. Nancy, Ned von Valkenberg, Peter Bannier and other Anti-war leaders. Again he was refused by everyone he contacted.

9. On January 6, 1972, the attack was made on Peter Bannier's home by Godfrey and someone else, whose identity as yet remains unknown.

10. In February, 1972, on two occasions, shots were fired at Mr. Richard Fleming at his home. (He, like Hoover and I, had refused to go along with any of Godfrey's wild ideas.)

My apartment in San Diego was under surveillance by someone and I was fired at on one occasion where I was staying out of sight. Godfrey told Mr. Hoover that, "Bannier's People figure it was you and Busch who took the shots

at the house in San Diego. They've put  
out a contract on you [b. 1]."

No sooner was this said than  
Godfrey began to pressure me to  
return to my apartment. (He had  
told Mr. Hoover not to tell me  
about the "contract" or the sur-  
veillance, but Mr. Hoover did. I  
reflected that outside of Mr.  
Fleury, who had also been shot at,  
Mr. Hoover, his employer and my  
mother, only Godfrey knew where  
I was staying. I thus concluded  
it was he and/or members of his  
(by his claim) forty person "intelligence"  
network who had fired the shots  
at Mr. Fleury and ~~myself~~ myself.

Therefore, on March 2, 1972, I left  
San Diego County and the United States  
in fear of my life. (One can not,  
after all, protect oneself from a  
hidden assassin!) In light of what  
has transpired since, I have re-  
mained out of the area ever since.

Sure hope this will help Bill.

Best of luck,  
Jimmy Brael

P.S. Bill, just talked  
today (Friday, 7-6) with  
Wanda Trout of L.A. Times.  
Please send her a copy  
of this. J.B.

Date prepared

6/17/74

Date received

6/17/74

Received from (name or symbol number)

INFORMANT

Received by

SA Earl M. Peterson

Method of delivery (check appropriate blocks)

in person  by telephone  by mail  orally  recording device  written by Informant

If orally furnished and reduced to writing by Agent:

Date

Dictated \_\_\_\_\_ to \_\_\_\_\_

Transcribed \_\_\_\_\_

Authenticated by Informant 6/13/74

Date of Report

6/13/74

Date(s) of activity

Brief description of activity or material

Info re MCC, Posse Comitatus  
\* individual

File where original is located if not attached

170-512A

\* INDIVIDUALS DESIGNATED BY AN ASTERISK (\*) ONLY ATTENDED A MEETING AND DID NOT ACTIVELY PARTICIPATE IN VIOLENCE OR REVOLUTIONARY ACTIVITIES WERE NOT DISCUSSED.

Information recorded on a card index by \_\_\_\_\_ on date \_\_\_\_\_

Remarks:

- (/ ) 170-512A - 281
- ( ) 157-4323 (MCC)
- ( ) 105-6730 (AL FATAH)
- ( ) 105-7470 (JDL)
- ( ) 157-4340 (LIBERTY AMENDMENT)
- (/ ) 157-4168 (MCC)
- (/ ) 157-23 (NSWP)
- ( ) 157-4024 (ELLEN ADAMS)
- ( ) 157-4448 (AL ALDINGER)
- ( ) 157-4018 (JOSEPH BENINTENDE)
- (/ ) 157-2527 (HARRIET BRINKER)
- ( ) 157-3484 (JANET BRINKER)
- (/ ) 157-3097 (JOSEPH BRINKER)
- ( ) 157-4019 (ROBERT BROWN)
- ( ) 157-4076 (BERT CAMPERAT)
- ( ) 157-2897 (WILLIAM DOMASK)
- (/ ) 157-152 (RON EDDY)
- ( ) 157-4449 (JOHN FINN, JR.)
- ( ) 157-3300 (P.T. GAVIN)
- ( ) 157-4269 (KENT GEDDIS)
- ( ) 157-4434 (NELLY JOHNSON)

Index to 157-4168  
Posse Comitatus  
JACK FREDERICK

Block Stamp

157-2815-417

SEARCHED	INDEXED
SERIALIZED	FILED
JUN 19 1974	
FBI - SAN DIEGO	

EMB: 9

( / ) 157-4407 (Dr. CHARLES WELT KENDALL)  
 ( ) 157-2893 (THOMAS FRANKLIN KNIGHT)  
 ( ) 157-4450 (ROBIN LIPPERT)  
 ( / ) 157-3487 (DENNIS LOSO)  
 ( ) 157-4131 (CHARLES MARTIN)  
 ( / ) 157-2521 (DAVID "BILL" MILLER)  
 ( ) (ANN NATTER)  
 ( ) 157-4273 (WILLIAM PROBERT)  
 ( ) 157-4553 (ROBERT RAYBURN)  
 ( ) 157-3498 (WESLEY ROUNDS)  
 ( ) 157-4274 (Mr. KARL SACK)  
 ( ) 157-4275 (Mrs. KARL SACK)  
 ( ) 157-4252 (CARL SCHMIDT)  
 ( ) 157-4271 (DONALD SEABURG)  
 ( ) 157-4029 (ART SHOOT)  
 ( ) 157-4546 (J. ANDREW SIMPSON)  
 ( / ) 157-201 (GERALD SMITH)  
 ( ) 157-4248 (GEORGE UDBARY)  
 ( ) 157-4266 (MARY UDBARY)  
 ( ) 157-2610 (MICKEY WAKEFIELD)  
 ( / ) 157-3138 (VICTOR WALTON)  
 ( ) 157-2524 (GERALDINE WATSON)  
 ( ) 157-2545 (RAY WILSON)  
 ( ) 157-2506 (JACK ZIMMERMAN)  
 ( ) 157-4447 ( BARBARA HUTCHINSON)  
 ( ) 157-4545 (CHANCEY CURR)  
 ( ) 157- (Bernard Dower)  
 ( ) 157-4023 (ARNOLD DRESSEN)  
 ( ) 157-3169 (DONNA LEE HARTLEY)  
 ( ) 157-3170 (CALVIN FOX)

1- 157-3121 (Busche)

1- 157-2933 (McDade)

① 157-2815 (SAO)

1- 157-3017 (Hovver)

1- 157- (George Metzger)

1- 157- (Joe Reedy)

RCT: Posse Comitatus.

During the last two years this informant has spent a great deal of time studying the tactics, personalities and stated goals of both the National Socialist White People's Party and the Ministry of Christian Church. Until recently I considered the NSWPP to be more of a threat to the security of peace and law in the United States than the MCC but recent events of recent months have caused me to change my view of these groups about 180 degrees. I now regard the MCC to be a far greater threat than the NSWPP is likely ever to become.

The main reason for my change of relative attitudes toward these groups has been the increased preoccupation of certain MCC members with the Posse Comitatus. Also known as the Christian Posse Association, this organization serves as the paramilitary arm of the MCC. The goals of its most ardent activists seem to be very similar to those of the Nazis but their tactics are quite different. Instead of wrapping themselves in the Swastika, they uphold the Christian Cross as their symbol. Unlike the head-on street clashes which many of the Nazis seem to relish, members of Posse Comitatus generally tend to prefer being secretive and underhanded in their operations. They generally seem to fancy themselves to be revolutionaries and as fanatical as some of them appear, I believe a great potential exists for the Posse to become a truly revolutionary group.

Dennis Loso was at one time a major financial supporter of the NSWPP. He has renounced that group since 1972 but not because of its policies but only because he considers it to be ineffective. He is now a dedicated supporter of the MCC and its national leader, William Gale. Loso almost never misses an MCC meeting in San Diego, frequently visits the Glendale meetings of MCC, and more recently attended the MCC seminar at Manassa Ranch in Mariposa. If Loso is not already an officer within the Posse Comitatus, then the potential certainly exists for him to become one. Loso is also an admirer of Jack Fredericks and was just elected to the San Diego County Central Committee of the American Independent Party.

Welt Kendall, another ex-Nazi supporter who has turned to the MCC, is also a potential activist for Posse Comitatus. Kendall attends perhaps a number of Gale's meetings in San Diego and is definitely not bothered by the prospect of using violence to attain political goals. He once suggested that Sheriff John Duffy of San Diego County should be assassinated.

Jerry Busch, a.k.a. Mark Roberts, is another man to watch. He stresses the importance of MCC members

outside the realm of normal correspondence. Two-way radio contact seems to be his favorite. Busch once stated his desire to murder Deputy District Attorney Hewicker of San Diego. Busch is very suspicious and paranoid of everyone.

Sian McDade, former Secret Army Organization affiliate, is definitely in the Posse Comitatus picture. He occasionally attends MCC meetings in San Diego. A friend of George Hoover, McDade made a feeble write-in campaign for sheriff against John Duffy but it never amounted to much. About the only support he received came from affiliates of the Posse.

Joe and Harriet Brinker are almost sure to be members of Posse Comitatus. Long time supporters of the MCC, they never miss a meeting or other MCC activity and have often driven long distances across country just to participate in such events. Harriet is definitely the brains of this pair. In spite of their very radical political stance, however, this informant does not consider either one of them to be capable of a premeditated act of violence.

George Metzger seems to be very deeply involved in Posse Comitatus. He is an organizer, a "take charge" man and a pretty good speaker both in private and before groups. He is not dynamic but speaks carefully, deliberately and with an air of sincerity and believability. Certainly his actions should be observed.

Joe Reedy is a close associate of Metzger. He seldom has much to say and appears merely to be a faithful follower who would be willing to go along with whatever the others decide.

Bill Miller is very closely tied with the MCC and has been for a long time. However, he is definitely not the violent type. He tapes every one of Gale's sermons and never misses a meeting. Gerald Smith kicked Miller out of the NSWPP because he considered him to be cowardly and more interested in promoting the MCC than the NSWPP.

Ron Eddy is a man who owes allegiance to no particular group or leader but who could very likely become involved in a group like Posse Comitatus. He has been a long time supporter, if a sporadic one, of the NSWPP. At one time Eddy was a Gale follower but he has had nothing to do with the MCC since 1972 because he now considers Gale to be a phony. I am sure that Eddy would have no scruples at all about assassination if he thought the chances of getting away with it to be feasible. He is distrustful of organizations but just this very night stated that if any good is to be done, then we must have a certain amount of organization: you can't just have a bunch of individuals running around.

Eddy stated, however, that he is very distrustful of anyone whom he has not known for a very long time and would definitely do some extensive checking into a person's background before trusting him as a confederate in any terrorist activity. Eddy seems to enjoy violence but he is also a clever, intelligent man and should never be underestimated. I regard him as being one of the most dangerous people named in this report even though I do not believe him to be a member of Posse Comitatus as yet.

Vic Walton is another figure who is likely to have a hand in the organization of Posse Comitatus in San Diego County. This attorney, in this informant's opinion, presents no threat of physical violence whatever but he serves as a sort of liaison man between the various right-wing extremist groups in the Southern California area. He is intelligent and seems to be fairly well off financially. Through him many others can be reached as Walton has been involved with people in the NSWPP, the MCC, the SAO, Comparet's group and virtually any other extremist outfit in the right-wing which one might think of in this area.

I hope this report will give you some idea as to the current status of Posse Comitatus in San Diego County. At least I believe it to be a fairly accurate description of some of the prime-movers of Posse Comitatus as of the present. Due to the more underground nature of this group, it is more difficult to keep tabs on than is the openly Nazi Party. However, as this organizational arm of the MCC makes the attempt to establish itself as a force to be reckoned with and to consolidate whatever power it might gain, certain characteristics of it are bound to surface and become more clear. This informant will do his best to learn as much about this emerging group as quickly as possible and to relay the information to you as accurately as can be done. One thing seems to be very certain and that is that San Diego County seems to be extremely fertile soil for the flourishing of a group like Posse Comitatus.

That is all for now.

INFORMANT

Date received: 4/5/74      Informant: INFORMANT      Received by: Sgt Earl M. Peterson

Method of delivery (check appropriate blocks)  
 in person     by telephone     by mail     orally     recording device     written by:

If orally furnished and reduced to writing by Agent:  
 Dictated 4/6/74 to Sue Fox  
 Transcribed 4/8/74  
 Authenticated by Informant: \_\_\_\_\_

Date of Report: 4/5/74

Date(s) of activity: 3/28/74

Brief description of activity or material:  
MCC meeting 3/28/74 - S.D.

File where original is located if not at:  
170-544A

\* INDIVIDUALS DESIGNATED BY AN ASTERISK (\*) ONLY ATTENDED A MEETING AND DID NOT ACTIVELY PARTICIPATE IN VIOLENCE OR REVOLUTIONARY ACTIVITIES WERE NOT DISCUSSED.  
 Information recorded on a card index by \_\_\_\_\_ on date \_\_\_\_\_

Remarks:

- (/ ) 170-544A - 10
- ( ) 157-4323 (AFCJ)
- ( ) 105-6730 (AL FATAH)
- ( ) 105-7470 (JDL)
- ( ) 157-4340 (LIBERTY AMENDMENT)
- (/ ) 157-4168 (MCC)
- ( ) 157-28 (NSWPP)
- (/ ) 157-4024 (ELLEN ADAMS)
- ( ) 157-4448 (AL ALDINGER)
- ( ) 157-3018 (JOSEPH BENINTENDE)
- (/ ) 157-2527 (HARRIET BRINKER)
- (/ ) 157-3484 (JANET BRINKER)
- (/ ) 157-3087 (JOSEPH BRINKER)
- ( ) 157-4019 (ROBERT BROWN)
- ( ) 157-4076 (BERT CAMPERAT)
- ( ) 157-2897 (WILLIAM DOMASK)
- ( ) 157-152 (RON EDDY)
- ( ) 157-4449 (JOHN FINN, JR.)
- ( ) 157-3300 (P.T. GAVIN)
- ( ) 157-4269 (KENT GEDDIS)
- ( ) 157-4434 (NELLY JOHNSON)

INDEX TO 157-4168  
 Christian Defense League  
 CALIFORNIA RAIDERS  
 Colonel WILLIAM GALE  
 (BACKGROUND)  
 TAX EXPO 4/5-6/74

Further dissemination left to receiving office.

- 1- 170-286 (Hoofery)
- 2- LOS ANGELES (157-7775) (RM)

EMP: cf  
 (19)

Block Stamp

157-2815-416

SEARCHED	INDEXED
SERIALIZED	FILED
APR 1 1974	
FBI - SAN DIEGO	



- ( ) 157-4407 (CHARLES WELT KENDALL)
- ( ) 157-2898 (THOMAS FRANKLIN KNIGHT)
- ( ) 157-4450 (ROBIN LIPPERT)
- ( ) 157-3487 (DENNIS LOSO)
- ( ) 157-4131 (CHARLES MARTIN)
- (f) 157-2521 (DAVID "BILL" MILLER)
- (i) 157-4443 (ANN NETTER)
- ( ) 157-4273 (WILLIAM PROBERT)
- ( ) 157-4553 (ROBERT RAYBURN)
- ( ) 157-3498 (WESLEY ROUNDS)
- ( ) 157-4274 (Mr. KARL SACK)
- ( ) 157-4275 (Mrs. KARL SACK)
- ( ) 157-4252 (CARL SCHMIDT)
- ( ) 157-4271 (DONALD SEABURG)
- ( ) 157-4029 (ART SHOOT)
- (i) 157-4546 (J. ANDREW SIMPSON)
- ( ) 157-201 (GERALD SMITH)
- (f) 157-4248 (GEORGE UDBARY)
- ( ) 157-4266 (MARY UDBARY)
- (i) 157-2610 (MICKEY WAKEFIELD)
- (i) 157-3138 (VICTOR WALTON)
- ( ) 157-2524 (GERALDINE WATSON)
- ( ) 157-2545 (RAY WILSON)
- ( ) 157-2506 (JACK ZIMMERMAN)
- ( ) 157-4447 (BARBARA HUTCHINSON)
- ( ) 157-4545 (CHANNCEY CURR)
- ( ) 157- (Bernard Dower)
- ( ) 157-4023 (ARNOLD DRESSEN)
- ( ) 157-3169 (DONNA LEE HARTLEY)
- ( ) 157-3170 (CALVIN FOX)
- 1 157-4446 (JONATHAN WEST)
- 1 - 157-3001 (Jenny Lynn Davis)
- (1) 157-2815 (SAO)

Report by INFORMANT

4/5/74

Meeting of Colonel WILLIAM GALE at  
O'Neira Hall on the Evening of  
March 28, 1974, San Diego, California

Approximately 75 persons were present at that meeting. It included, among others, GEORGE UDVARY, VICTOR B. WALTON, MICKEY WAKEFIELD, J. ANDREW SIMPSON, ELLEN ADAMS, BILL MILLER, JONATHAN WEST, JOE BRINKER, HARRIET BRINKER, JANET BRINKER, Colonel WILLIAM GALE, ANN NUTTER, and others who are very old and very inactive. There were a number of individuals present who are as yet unknown to me.

GEORGE UDVARY does not seem to have made his move yet--permanent move out of the area. He's still in process, I believe, as best I can tell at this time. MICKEY WAKEFIELD came down from Escondido, was hoping to run into some of his para-military friends, one or two of whom did not evidently arrive. He did run into VICTOR WALTON who he is close to. BILL MILLER was there and very involved--on the surface at least. ELLEN ADAMS was distributing literature. JOE and HARRIET BRINKER came in from Escondido and of course are primarily responsible for putting on that monthly meeting and so they were working with that.

There was security that night--more so than would ordinarily be expected. A fellow by the name of DENNIS was inside with a 23-channel, five-watt Citizens Band walkie-talkie, Realistic brand, sold by Radio Shack. He kept monitoring another individual whose name I do not have who was outside. He had a two or three channel Citizens Band walkie-talkie, Midland brand, and they were checking to see if anyone would give them any trouble. This was because of a publication that indicated where their meeting would be held. They didn't indicate what they would do if such trouble arrived.

Colonel GALE discussed an article on himself and the identity movement as written up in Volume V, Issue 14, of a bi-monthly publication, called the San Diego Door. I believe that's a March, 1974 issue. Colonel GALE read directly from the article and made comments and corrections as he went.

He said, now I will read--follow this and read as much as possible that seems relevant. He read from the article: "But the public meetings are only part of the package. Whenever GALE speaks, he recruits followers into the para-military part of his organization. That part is called 'Identity' and has so far incorporated many old Minutemen and secret army elements in Southern California."

To that, Colonel GALE indicated that "Identity" was the name of his church publication--he thought it was

very humorous that they thought it was something else.  
The term is used to describe their philosophy.

The para-military part of their operation is under such titles as the "Christian Posse Association."

I will make another quote here from the publication: "JERRY LYNN DAVIS, the ex-head of the SAO in California, has been reported at GALE's public meetings." According to MICKEY WAKEFIELD who was sitting next to me during this meeting, DAVIS had not, as far as he knew, ever been to a San Diego meeting.

Another quote Colonel GALE made: "Identity is organized in similar fashion to other underground organizations-- small cells communicate through a series of intermediaries and blind post office boxes." Colonel GALE did not comment further; however, the mailing network for the national tape groups, the Christian Posse Association groups, and the amateur radio network are the primary communication links of GALE's group.

Another quote Colonel GALE made from the article: "In San Diego, GALE can be heard speaking to his congregation on the fourth Thursday of every month at the O'Neira Club on Holly Street" or something of that nature "between 34th and 35th Streets, one block south of Adams Avenue." The street was incorrectly quoted--it's Hawley, and Colonel GALE made an observation on that, indicating he thought the information was transferred to the person at this publication

by telephone and that he figured, he had that all figured out that way because the person must have misunderstood the name and got it wrong.

The next quote from the publication: "According to one law enforcement source, Identity has about 50 members in the San Diego area, including members of the San Diego Sheriff's Department and reserve police officers." Colonel GALE indicated support from and for law enforcement--indicated he has an assistant pastor in Glendale who has an important position in the Los Angeles County Sheriff's Office, and that he claims support from a number of law enforcement areas.

Another quote he indicated: "As for GALE, he pretends to be a minister of his church and operates through it as his front. GALE was one of the driving forces behind the militant Christian Defense League (CDL) in the 60's. He had formed the small California Rangers in the late 50's. The California State Attorney General's Office described the Rangers as," then they put a quote in here, in this article, " 'A secret underground guerrilla force, linked with other non-military organizations by a common ideology and leadership.' "

Colonel GALE indicated at this meeting the Rangers were registered with the state and had support of California law enforcement.

Another quote from the article that the Colonel

made: "GALE's strategy to recruit members through veterans organizations was thwarted in 1963 when the Long Beach Press Telegram exposed his efforts to convert the American Legion Post in Signal Hill into a Ranger front. It was after this that one of the Rangers was arrested for selling a machine gun and a stem gun to undercover agents." Colonel GALE indicated that he was involved to some extent with this particular post, with this particular veterans group, that he transferred from the Hollywood post. Also, he said that the Ranger's, that particular Ranger's arrest, was an entrapment and an unfortunate error on that Ranger's part.

Another quote he made: "The CDL was quite an organization when GALE was a part of it. It grew to include the Klan, the National States' Rights Party, and many other Right Wing groups." Colonel GALE admitted connection with the Christian Defense League, indicating that he was very active.

Another quote: GALE has ample experience to found a para-military organization. In addition to more than 20 years involvement in right wing circles, GALE is a retired Lieutenant Colonel, U. S. Army. He served with the MAC ARTHUR command after World War II in the counter-insurgency staff," and it goes on. But Colonel GALE corrected this counter-insurgency information. He indicated that he was on the staff of MAC ARTHUR in Japan, but previous to

that was when he was involved in counter-insurgency and that was with the guerrilla activities in the Philippines, which was also indicated in this article.

Then, another interesting thing, he quoted: "The SAO was in large part organized by HOWARD B. GODFREY, an FBI Agent." He didn't have anything notable to say about GODFREY.

Actually, one of the things he indicated, too, in this discussion of his was that there is a lot of difficulty getting different right wing groups to cooperate in a military fashion and that that is very necessary and I get the impression that he is attempting and wishes to whip these groups into line in a really efficient military manner that will be very effective and efficient. That is the primary problem. He also indicated his willingness to cooperate with law enforcement, of course on his terms no doubt; and he said he was ready and they were ready to face those Jews and their articles and their so-called exposes and whatever else they might happen to want to do; that they are ready to communicate with their people and take care of anyone who gives them any trouble. He indicated that he had communication links all over--that from his car he could talk immediately with his link in Saugus--I don't know what link he was referring to, but it was in Saugus, and in Glendale and other areas like that, which he mentioned.

That covers much of his comments at that particular meeting. There was quite a lot of response--the people enjoyed that immensely. It was a reaction similar to a grandstanding and I think he was milking it for all he could get.

J. ANDREW SIMPSON resides at 229 Kalmia Street, San Diego, California 92101, telephone number in San Diego 232-5658.

There were some questions and answers during this session. JOE BRINKER was passing out blank pieces of paper so that people could write their comments and questions on the papers which were then passed up to Colonel GALE. Along with those blank pieces of paper, JOE BRINKER had a throw-away on the tax revolt. The heading was "Sunny San Diego Invites You to 1974's Biggest Tax Expo" and then another heading, "Tax Foes Tell Why and How They Stopped Paying Income Tax," etc., etc. It talked about meetings in the San Diego area on that. Registration forms for special get-togethers, in this case, Sheraton Inn-Airport on Friday, April 5th and Saturday, April 6th, 7 P.M. to 11 P.M. on Friday, April 5th; 9 A.M. to 5 P.M. Saturday, April 6th. For those who wish to write for information, they'd write to (for registration or information) to Tax Expo, 1570 Lily Avenue, El Cajon, California 92021. Now whether this point was being stressed more by JOE BRINKER or whether it was also under the tacit approval of Colonel GALE, I do not know.



Among the other literature and material which was picked up at that meeting, I acquired an application for the Identity seminars, "Second and Third National Identity Seminars, Manasseh Ranch, California, Ministry of Christ Church. Second Seminar dates are Saturday, the 26th of April through Tuesday, the 30th of April, 1974. Third Seminar dates are Saturday, the 29th of June through Tuesday the 2nd of July; 1974. Attendance by accepted application only--not open to the public." (They make that a stressed point in this.) "Manasseh Ranch is the national headquarters for the Identity Movement of the Ministry of Christ Church. It is located in the gold Mother Lode area of California. Altitude is nearly 3,000 feet in the high Sierra Nevada Mountains. No sleeping facilities are available so those attending should bring a motor home, camp trailer, camper truck, or travel trailer. If you do not own one, they can be rented for a nominal fee. Since bath and toilet facilities are limited, self-contained recreational vehicles are preferable. You must also bring your own food supply, except that we will have a small commissary to supplement your needs--eggs, bread, butter, potatoes, canned foods, etc. Children will be the responsibility of the parents, although it is possible to arrange for a child care period among those who attend. This can be organized after your arrival. Directions to Manasseh Ranch will be mailed to

you upon receipt of and acceptance of your application to attend. (Please cut off at perforated line and mail application to P. O. Box 423, Glendale, California 91209. Please give the information requested on the application form.)"

Underneath the application: "We wish to attend the Identity Seminar at Manasseh Ranch as indicated. Please place checkmark in the appropriate seminar space." Second Seminar or Third Seminar indicated for placement of the mark.

Following they say, "Religious services begin on Saturday, so arrivals should be prior to those dates." They ask the number of adults, number of children, ages of children, type of recreation vehicle (tent camper, truck camper, motor home, travel trailer), then they indicate here, "We hereby relieve the Ministry of Christ Church from all liability and responsibility to ourselves and all members of our family in event of accident or injury while we are on the church property at Manasseh Ranch, California. . .Name (signed), Address (printed)". . .so on. This is the form for the seminars.

MINISTRY OF CHRIST CHURCH

SECOND SEMINAR - Dates are SATURDAY, 26 April thru TUES. 30 April 1974

THIRD SEMINAR - Dates are SATURDAY 29 June thru TUES. 2 July 1974

ATTENDANCE BY ACCEPTED APPLICATION ONLY - NOT OPEN TO THE PUBLIC !

MANASSEH RANCH is the NATIONAL HEADQUARTERS for the IDENTITY movement of the MINISTRY OF CHRIST CHURCH. It is located in the gold mother-lode area of California. Altitude is near 3,000 feet in the High Sierra Nevada mountains.

No sleeping facilities are available, so those attending should bring a motor home, camp trailer, camper truck or travel trailer. If you do not own one, they can be rented for a nominal fee. Since bath and toilet facilities are limited, self-contained recreational vehicles are preferable. You must also bring your own food supply except that we will have a small commissary to supplement your needs (eggs, bread, butter, potatoes, canned foods, etc.).

Children will be the responsibility of the parents although it is possible to arrange for child care periods amongst those who attend. This can be organized after your arrival. Directions to Manasseh Ranch will be mailed to you upon receipt of and acceptance of your Application to attend.

(Please cut off at perforated line and mail application to P.O. Box 423, Glendale, California 91205). Please give the information requested on the application form)

A P P L I C A T I O N

We wish to attend the IDENTITY SEMINAR at Manasseh Ranch as indicated. (Please place check mark in the appropriate Seminar space)

( ) Second Seminar - Sat. 26 April thru Tues. 30 April 1974

( ) Third Seminar - Sat. 29 June thru Tues. 2 July 1974

Religious Services begin on Saturdays, so arrivals should be PRIOR to those dates.

Number of adults _____	Type of Recreational Vehicle:
Number of children _____	Tent camper _____ Motor Home _____
Ages of children _____	Truck camper _____ Travel Trailer _____

We hereby relieve the Ministry of Christ Church from all liability and responsibility to ourselves and all members of our family in the event of accident or injury while we are on the Church property at Manasseh Ranch, California.

NAME (signed) \_\_\_\_\_

TWO PAGES DELETED

AS TENDS TO

IDENTIFY INFORMANT

Date prepared

12/11/73

Date received

12/10/73

Received from (name or symbol number)

INFORMANT

Received by

SA Earl W. Peterson

Method of delivery (check appropriate boxes)

- in person
- by telephone
- by mail
- orally
- recording device
- written by Informant

If orally furnished and reduced to writing by Agent:

Date

Date of Report

12/6/73

Dictated \_\_\_\_\_ to \_\_\_\_\_

Transcribed \_\_\_\_\_

Date(s) of activity

Authenticated by Informant 12/6/73

Brief description of activity or material

Paul Rughnizer, wife & friend  
attached  
Letter by Ray Wilson

File where original is located if not attached

SD 170-572A

\* INDIVIDUALS DESIGNATED BY AN ASTERISK (\*) ONLY ATTENDED A MEETING AND DID NOT ACTIVELY PARTICIPATE. VIOLENCE OR REVOLUTIONARY ACTIVITIES WERE NOT DISCUSSED.

Information recorded on a card index by \_\_\_\_\_ on date \_\_\_\_\_

Remarks:

- (1) SD 170-572A - ~~174~~ 174
- (1) 157-2815 (SAO)
- 1-157-3228 (Paul Rughnizer)
- (1) 157-28 (NEWPP)
- ( ) 157-152 (RON EDDY)
- ( ) 157-3300 (PETER GAVIN)
- ( ) 157-4229 (MIRE JOHNSON)
- ( ) 157-3860 (FRANK KERR)
- ( ) 157-3104 (CAROL KNIGHT)
- ( ) 157-2238 (FRANK KNIGHT)
- ( ) 157-4131 (CHARLES MARTIN)
- ( ) 157-4223 (KYLE MOORE)
- ( ) 157-201 (GERALD SMITH)
- (1) 157-2610 (HICKEY WAREFIELD)
- ( ) 157-3138 (VIC WALTON)
- (1) 157-2545 (RAY WILSON)
- ( ) 157-2506 (JACK ZIMMERMAN)
- ( ) 157-4018 (Joseph Benintende)

Do not disseminate fact that we have letter written by Ray Wilson as it will compromise source.

Index to 157-28

SEAN MAQUIRE

157-3110\*  
157-28-354 p.4

EMP: y  
(16)

Block Stamp

157-2815-412

SEARCHED	INDEXED
SERIALIZED	FILED
DEC 11 1973	
FBI - SAN DIEGO	

Report by INFORMANT

December 6, 1973

SUBJECT: Thugs attack SAO member.

As you can tell by the content of the enclosed letter, terrorist activity seems still to be going on in San Diego County. If true, what the letter says definitely refutes Paul Ruplinger's denial that he was a member of the Secret Army Organization.

This beating incident also seems to bear out this informant's suspicions that there is a leftist underground SAO type organization operating in the San Diego area. Perhaps these assailants who attacked the Ruplingers and their friend were the same group who shot up the mobile home park in Condido where Mickey Wakefield resides. In any event, this latest violence is bound to heighten tensions between the warring factions.

Ray Wilson is obviously very pleased that the Zionist headquarters in New York was bombed. It was news to this informant to learn that Wilson's landlady is a close friend of the Ruplingers. This means that she must be at least semi-politically aligned with the Ruplingers and possibly even Wilson himself.

That is about it for now. Hope this will help.

INFORMANT

# Memorandum

DATE:

11/1/73

TO : SAC (157-2815)

FROM : SA Earl M Peterson

SUBJECT: SAO

The attached article appeared in the Ramparts  
Magazine Vol 12 # 3 October 1973,

For file.

EMP: 8  
(1)

FILE STRIPPED

3-7-74 DAN

157-2815-411

SEARCHED	INDEXED
SERIALIZED	FILED
NOV 30 1973	
FBI - SAN DIEGO	



Buy U.S. Savings Bonds Regularly on the Payroll Savings Plan

# THE STRANGE TALE OF THE SECRET ARMY ORGANIZATION (USA)

San Diego is a strange town, where the niceties of Western civilization cannot hide the power of the buck and the hint of brute force. It is the city built with the largesse of twenty-five years of imperial sway: a stronghold, a haven of anticommunism, a base for racketeers. Richard Nixon considered it his lucky city. He wanted the Republican Convention to be held there, and though the city fathers and the people of San Diego were not terribly enthusiastic, the plans went forward until May 1972, when the President abruptly changed his mind.

Included in these plans, it turns out, was a tumultuous, massive, bloody riot—on such a scale as to justify the most extraordinary preventive measures, including burglary, bugging, sabotage, and perhaps even kidnapping. Watergate, we learn from the likes of John W. Dean, was simply part of a strategy to maintain domestic tranquility in the face of a serious left-wing threat.

Presumably, this Red Menace existed in San Diego as well as Miami. But San Diego has never been a radical stronghold, and while local activists did undertake extensive preparations for anti-war demonstrations during the GOP convention, the Committee to Re-elect the President seems to have had a far higher opinion of their organizing successes than they themselves dared to entertain.

Unless, of course, CREEP and its local San Diego allies were hell-bent on making certain that bedlam did in fact occur. That is precisely what a defecting *agent provocateur* named Lewis Tackwood suggested almost two years ago. Tackwood told an incredible story back in October and November 1971, one which suggested the Republicans were doing their utmost to turn San Diego into a bloodbath during the convention, with the aim of annihilating the left, smearing the Democrats, and coasting comfortably into four more years of conservative rule. His allegations were regarded as the ravings of a madman until testimony in the Senate caucus room appeared to corroborate some of his wildest stories. He told of preparations to seal off and then bomb 100,000 demonstrators attending a rock concert on Fiesta Island in Mission Bay, San Diego. All sorts of mayhem was supposed to occur. Bombs were to be smuggled into Convention Center in hollow furniture, which was al-

*Richard Popkin taught philosophy at the University of California, San Diego and now teaches at Washington University, St. Louis. He is a world-renowned expert on skepticism and author of The History of Skepticism and The Second Oswald.*

ready being built in Los Angeles. At least one major Republican official would perish in the melee. The Democratic Party would be tied in to the events, discredited, possibly outlawed. The Republican candidate would then win an easy victory with the overwhelming support of an outraged citizenry. Today, Tackwood sticks by his original story (to be published in September by Avon as *The Glasshouse Tapes*), though he now adds that the plan also called for blowing up the podium as President Nixon was making his acceptance speech!

## [CIVIL WAR IN SAN DIEGO]

Incredible as the Tackwood scenario seemed back in 1971, it sounded less outlandish to San Diego radicals than to those on the outside. For two years, they had quite literally been engaged in protracted warfare with right-wingers determined to drive them out of the area. As early as 1970, activists associated with the San Diego *Street Journal*, an underground newspaper, were living in an armed fortress which they guarded around the clock against the attacks of night riders who would shoot into their houses, firebomb their cars and threaten their lives. (Curiously, this terror campaign intensified as the paper exposed more and more illegal activities of San Diego kingpin C. Arnholt Smith.) On one occasion, for example, sentries spotted two men crouched behind a car with a high-powered rifle trained on the house. It was late at night, but they were prepared for such emergencies. At a signal, they switched on floodlamps which bathed the house in light and they announced over a loudspeaker system that they would open fire if the men did not withdraw. The gunmen waited a moment, then dismantled their rifle, and drove off into the night.

By late 1971, the vigilantes had stepped up their attacks and had chosen their principal targets. One of these was a certain Peter Bohmer, a radical who at the time was teaching economics at San Diego State College. He began receiving threatening phone calls, and on November 13, 1971, a car parked in front of his house was firebombed. Then on December 27, 1971, a group calling itself the Secret Army Organization put out a Special Bulletin on Peter Bohmer. After listing his anti-war activities, and his background, the letter said: "For any of our readers who may care to look up this Red Scum, and say hello, here is some information

(Continued on page 56)

by Richard Popkin



# WANTED

## for TREASON



### NIXON

#### DESCRIPTION

**FULL NAME:** Richard Milhous Nixon. **DATE OF BIRTH:** January 9, 1913 at Yorba Linda, California. **FORMER OCCUPATIONS:** Used car salesman, law clerk, second rate congressman, and mediocre Vice President. **PRESENT OCCUPATION:** Professional liar and double crosser (part time employment as United States President). **WEIGHT:** 170 pounds. **EYES:** brown. **HAIR:** black. **HEIGHT:** 5'11". **RACE:** white. **NATIONALITY:** Claims American citizenship but actions prove this unlikely. **LAST KNOWN ADDRESS:** 1600 Pennsylvania Avenue, Washington, D. C. (Rumored to have a California hideout.)

#### CRIMINAL RECORD

RICHARD NIXON (alias Cry-Baby Nixon, aliases Tricky Dicky) is an expert in disguises and has successfully passed himself off as an anti-communist in the past. He may again try using this disguise if pressed for votes in 1972. Saying one thing, then doing the opposite is Nixon's MOA. While he campaigned in 1968 on a platform of curtailing socialism he has in fact done more to establish a socialistic dictatorship than either of the last two Democrat administrations. His economic policies have continued to enrich Big Industrialists while rising prices and higher taxes have all but reduced the average worker to a state of financial slavery. This criminal has even made vicious attacks on small children (forced busing to achieve "racial balance") and has caused the destruction of local school systems. **WARNING:** Nixon suffers from an EMPEROR COMPLEX and becomes extremely dangerous when criticized.

#### CAUTION

Trickery and deceit are Nixon's trade-marks. At the present time Nixon and his chief henchman HENRY (CZAR) KISSINGER are engaged in forming an alliance with another gang of criminals, the Red Chinese. The RED CHINA GANG have slaughtered an estimated fifty million of their own people since coming to power. This Godless horde of barbarians killed thousands of Americans in the Korean War (shooting captured soldiers and starving and torturing prisoners of war). The RED CHINA GANG have been supplying the NORTH VIETNAMESE BANDITS with weapons and bullets to kill American soldiers in another no-win war in Vietnam. The very fact that Nixon is dealing with these ARCH ENEMIES OF FREEDOM is enough to convict him of treason. **DO NOT LET THIS CRIMINAL STEAL YOUR FREEDOM. DEMAND HIS ARREST BY PROPER AUTHORITIES AND HIS TRIAL FOR THE CRIME OF HIGH TREASON.**

⊕ Secret Army Organization



WANTED

FOR

## TREASON

THIS MAN is wanted for treasonous activities against the United States

- 1 Betraying the Constitution which he swore to uphold. He is turning the sovereignty of the U.S. over to the communist controlled United Nations. He is betraying our friends Cuba, Katanga, Portugal, and betraying our enemies Russia, Yugoslavia, Poland.
- 2 He has been WRONG on innumerable issues affecting the security of the U.S. United Nations, Berlin wall, Missile removal, Cuba, West deals, Test Ban Treaty, etc.

- 3 He has been lax in enforcing Communist Registration laws.
- 4 He has given support and encouragement to the Communist inspired racial riots.
- 5 He has illegally invaded a sovereign State with federal troops.
- 6 He has conspired to appoint Anti-Christians to Federal office. Upholds the Supreme Court in its Anti-Christian rulings.
- 7 He has been caught in fantastic LIES to the American people including personal ones like no previous marriage and divorce.

Warren Commission Exhibit 996

"Godfrey testified that he had paid the printer for the posters, picked them up, and was reimbursed by the FBI, and that the FBI understood the nature of his expenditures and saw all of his SAO publications."

## SECRET ARMY

(From page 36)

[SECRET ARMY-USA]

that may help." Then his address, phone number, and car license were given, plus a physical description. "Now, in case any of you don't believe in hitting people who wear glasses, to be fair, I guess we will have to tell you he wears contact lenses."

On January 6, 1972, cross-hair stickers (the symbol of the SAO) were placed on the doors of three San Diego State College professors, including Bohmer. Then, an anonymous caller telephoned Bohmer's residence to say, "This time we left a sticker, next time we may leave a grenade. This is the SAO." Bohmer's friends were called and told to say goodbye to him. That evening, two shots were fired into Bohmer's home and a woman named Paula Tharp was wounded.

The right-wing terror campaign continued for six more months, marked by death threats, menacing phone calls, and warning messages. Its climax came on June 19, 1972, when an SAO member bombed a local porno movie house, the Guild Theatre. This last event finally aroused the San Diego police to drive the group underground.

Police action brought a halt, at least temporarily, to right-wing terrorism in San Diego. But this is not the end of the tale. For in the months that followed a very bizarre story began to unravel, one which involved the SAO, the FBI, and some mysterious contacts between the terrorists and agents of CREEP. The pieces began to appear as early as mid-1972, but it is only in recent months that they have been pulled together by reporters for another San Diego alternative newspaper, the *Door*.

The SAO, it seems, grew out of the demise of the Minutemen. According to a recently discovered document entitled "History of the Secret Army Organization," it all began one morning in February, 1970, when "... a group of six Minutemen leaders from four states met secretly in Northern Arizona to discuss the crisis that the arrest and imprisonment of two top Minutemen leaders and the assassination of a third had brought on the organization. Although some of these men had met before in their roles as Minutemen group leaders, others were meeting for the first time." These men agreed that "the Minutemen as a national coordination organization of militant right wing groups had effectively been destroyed by the pro-communist elements inside the Justice Department," and they further agreed that the need for a coordinating organization was greater than ever "in view of the increased revolutionary activity by communists in the United States." The new organization was the Secret Army Organization, and it would save America from its leftward drift under Nixon's regime.

The initial SAO documents speak of the immediate need to set up paramilitary groups to carry on guerrilla warfare, and even open and conventional warfare. A letter from "General Headquarters" dated November 8, 1971, outlines the nature of SAO operations—combat teams, organization, transportation, travel procedures, weapons and equipment, training lessons, intelligence work, security, etc. They say that the country has entered

"Stage II": a time when most people still think they can still get along with the government, but "a few real patriots are willing to take part in underground activity." Stage II "will be a time of assassination and counter-assassination, terror and counter-terror." It is a period marked by "the communist infiltration and control of the present United States government."

SAO thus set out to wage total resistance to communism, a small band determined to risk all in the struggle for America. Nationwide, the group probably numbered less than 200 members, 30 of whom were active in San Diego county. There the group was founded by two men—Jerry Lynn Davis (Southland Coordinator) and Howard Berry Godfrey (San Diego Commander and Intelligence Officer).

In late 1971 and the first half of 1972 the SAO put out bulletins on how to make booby traps, how to use ammonium nitrate in high explosives, and how to gain forced entry into buildings. (Much of this information was taken from Department of the Army Technical Manuals on "Unconventional Warfare Devices and Techniques.") The San Diego SAO also put out bulletins about local liberals, radicals and anti-war activists, all of whom were lumped together as communists. (These missives went out to a mailing list of 227 names in the area, including a naval commander, a county supervisor, a vice admiral, a Marine Corps brigadier general, a rear admiral, and some San Diego police officers.)

The group was organized into small, semi-autonomous cells. Members were listed by code numbers, and were given mail drops for their contacts.

## [THE FBI CONNECTION]

SAO thrived in San Diego until the June 1972 bombing of the Guild Theatre led to the group's fall from grace. A former Birchite named William Francis Yakopec was arrested and charged with the bombing, and in September 1972, he was brought to trial in the Superior Court of the State of California in San Diego, before Judge Robert W. Conyers. Much to the astonishment of the SAO supporters, the star witness against Yakopec turned out to be San Diego Commander Godfrey. Then a local fireman, Godfrey admitted he had worked for the FBI since early 1967 as an undercover agent. He did it, he said, because "I felt it was my duty to my country." Before accepting the role, he had talked it over with J. Clifford Wallace, then the Stake President of the Mormon Church for San Diego, and more recently a federal judge by appointment of Richard Nixon. Wallace put Godfrey in touch with the FBI, and he was assigned to agent Steve Christianson, to whom he reported verbally every day. Godfrey was to work on the militant right wing, and was paid \$250.00 per month by the FBI. At first he was assigned to the Minutemen, and then with the demise of that group in San Diego, he helped start and run the SAO in November 1971. Godfrey testified that his FBI contacts knew all of his activities, including his stockpiling of illegal explosives in his house. This, he said, was done with their permission. (He later gave some of the explosives to Yakopec to "save them for after the Communist takeover of this country.")

Godfrey functioned as a one-man plumbers' operation within the SAO. He knew how to pick locks, burglarize, bomb and handle guns. The FBI paid his dues and covered his expenses. All this enabled him to carry on effectively as a terrorist. At Yakopec's trial, he said that he actively recruited for the group. What kind of people did he look for? "People with previous right wing connections." Did he enlist potentially dangerous elements? "Yes, sir."

Apparently, Godfrey himself was among the more dangerous elements in the SAO, and agent Christianson among the more dangerous eminences

grises of the operation. During the Yakopec trial, Godfrey admitted that he had driven the car from which another SAO member, George Hoover, had fired into Bohmer's house, wounding Paula Tharp. Subsequently, he had taken the weapon to Christianson, who had hidden it for six months. (This was evidently insufficient grounds for the FBI to take disciplinary action against agent Christianson. He continued as Godfrey's contact until the bombing of the Guild Theatre, at which point he was removed by L. Patrick Gray himself. He currently resides in Kanosh, Utah.)

In addition, Godfrey confessed to publishing a certain leaflet on February 18, 1972, the day on which President Nixon left for China. The bulletin was headlined "Wanted for Treason," and it featured a picture of Nixon and an inflammatory text which accused the President of high treason because of his China policy. The SAO symbol appeared at the bottom of the text, and the group distributed it in 15 cities—including San Diego, Phoenix, Yuma, San Francisco, and Bellingham, Washington.

At the Yakopec trial, Godfrey testified that he had paid the printer for the posters, picked them up, and was reimbursed by the FBI, and that the FBI understood the nature of his expenditures and saw all of his SAO publications. As for poor Yakopec, who had joined the SAO through Godfrey, his next door neighbor, he admitted to owning several of the posters: he said he stored them under his mattress. Why there? "I thought they were kind of corny." Later, he testified that he kept a bomb with the Nixon posters. Did he generally keep bombs under his bed? "No, I like to sleep too well." (When I visited the San Diego Court House to see the exhibit in question, the custodian located a stack of 33 posters, with the bomb casing still attached!)

It was not noted at the time, but in fact these posters bear a remarkable resemblance to leaflets which were distributed in Dallas, Texas, just one or two days prior to the assassination of President Kennedy. That poster likewise bore the headline "Wanted for Treason" and it also featured pictures (front and profile) of JFK and an inflammatory text about the President's

allegedly treasonous activities. On the hunch that the leaflet might have some connection with the assassination, the Warren Commission sent Secret Service agents to track down its author and printer. They worked from late November 1963, to May 1964, until they found that Robert G. Klause had printed the flyer and that Robert Allan Surrey, an associate of Gen. Walker, had ordered it. When Surrey testified before the Commission on June 16, 1964, he pled the Fifth Amendment on all questions concerning the leaflet. The late Hale Boggs, a member of the Warren Commission, pointed out that Surrey "is the only witness out of hundreds who has pled the Fifth Amendment." Klause denied any interest in or involvement with the contents of the leaflet, and there the matter was allowed to rest. By that point, the Warren Commission was determined to prove that Oswald had acted alone, and therefore lost interest in trying to connect the assassination with the leaflet.

Godfrey's surfacing as an FBI agent rattled the remnants of the SAO. They were angry at having been set up by the FBI, and when reporters for the *Door* began approaching their old adversaries for information earlier this year, they found that many were willing to cooperate; some were even friendly. And as the SAO began to open up, a pattern began to emerge which seemed to link the San Diego events to Watergate.

## [BREAKTHROUGH]

The breakthrough came this spring when an editor of the *Door* made contact with a former SAO militant named Jerry Busch. From November 1969 to the summer of 1971, said Busch, Howard Berry Godfrey made frequent visits to the Gunsmoke Ranch in El Cajon. "It was also during June, July, and August of 1971 that Berry Godfrey and Donald Segretti (posing as 'Don Simms') visited Gunsmoke and though supposedly not 'knowing each other,' they spoke together on at least one occasion," in a quiet conversation aside. The Segretti connection is important in itself; it is particularly interesting insofar as—according to Busch's account—Segretti was in touch with SAO

while contacting his old college chums Chapin and Strachan in June 1971, but before commencing work as a dirty trickster in September 1971.

Busch did not say what Segretti discussed at the Gunsmoke Ranch, but he did report that following "these casual conversations" Godfrey came up with bizarre ideas to take care of what he called "those red punks"—in the event that the GOP held its convention in San Diego. Among Godfrey's plans in October 1971, were:

- 1) the use of massive dosages of LSD, cyanide or strychnine introduced into the punch at anti-war group meetings;
- 2) bombing of the VVAW headquarters, the Guild Theatre, and several porno shops;
- 3) bombings of the homes or offices of anti-war leaders;
- 4) kidnapping or assassination of anti-war leaders and activists;
- 5) fire bombing of vehicles and other property belonging to anti-war activists.

By November and December 1971, Busch continued, Godfrey had become more ambitious: he wanted to acquire drone planes which would carry payloads of high explosives and phosphorus to be dropped on the demonstrators. In addition, Godfrey spoke of using similar air craft, loaded with TNT or C-4 plastique, to blow up Air Force One and assassinate Nixon. The idea was to fly a bomb into the Presidential jet as it landed either at Lindbergh Field or at El Toro Marine Base. Busch claimed that he had expressed horror at the suggestion and told Godfrey he had lost his mind suggesting anything as insane as an attempt on the life of the President. Shortly thereafter, Busch and Godfrey parted ways after the former grew suspicious that he was being set up to take the rap on the shooting of Paula Tharp. By March 1972, he had left San Diego and has not yet returned.

Even before Busch left the SAO, the "Wanted for Treason" leaflet was printed and distributed. Another former SAO member corroborates that in this same period—January-February, 1972—Godfrey tried to find someone to build a plane that would carry a load of high explosives. (In addition, he was apparently trying to obtain another plane for the purpose of gassing or bombing demonstrators on

Fiesta Island.) After Busch's departure, the SAO issued its April 1972, bulletin, which began with a quote attributed to Abraham Lincoln, "A tyrant would not come to the United States from across the sea. If he comes, he'll ride down Pennsylvania Avenue from his inauguration and take up legal residence of the White House." Then followed detailed instructions on the manufacture of explosives which might be used to destroy a large bridge (Tackwood's scenario included the demolition of two bridges on and off of Fiesta Island) and on various methods of forced entry into buildings.

#### [A SINISTER PLOT?]

Was there a right-wing plot to kill the President? Tackwood says so. Busch says that FBI informer Berry Godfrey talked about it. The "Wanted for Treason" poster certainly indicated no loss of love between the extreme right and the President, and Godfrey was checking out the availability of drone planes.

There are other curious, if admittedly inconclusive, clues as well: The day Nixon went to China, E. Howard Hunt was working as a public relations man on a Julie Nixon Eisenhower TV spot. He raged about the China trip, "We should not send people to China, we should send bombs to China." This from a man supposedly involved in a secret scheme to re-elect the President by illegal means.

Or take this item which appeared in the March 9, 1972, issue of the *N.Y. Times* (10 days after Nixon's return from China):

#### WAR ALERT SENT IN HOAX BY A COAST GUARDSMAN

"New Orleans, March 8 (UPI)—An enlisted man standing watch sent a hoax message to ships at sea during President Nixon's visit to China, saying the President had been assassinated and the Vice President had declared World War III, the Coast Guard revealed yesterday.

"The authorities said that the hoax message had not been taken seriously and that the man who sent it from a small Coast Guard station in Texas had been confined and was undergoing medical evaluation.

"The message was sent February 27 by teletype to 22 ships in the Gulf of

Mexico."

There was no further story on this that I have been able to find. If the hoax message had gone out to a Polaris submarine, Hunt might have gotten his wish, that bombs would be sent to China.

Then, the *L.A. Times* reported on July 13, 1973 that a former Minuteman had requested political asylum in Fiji, saying he had secret information on Watergate and feared assassination.

All of this proves nothing, of course, but it suggests that the Dirty Tricks operation may have been much more complex than we have been led to believe. Perhaps there was a plot to kill Nixon, and then again Godfrey's plot may have been a further hoax aimed at discrediting the left and the Democratic Party. What did Segretti discuss with Godfrey, and why and how did he meet Godfrey in the first place? How did it happen that the FBI financed a threat on the life of a President (a crime which carries a penalty of up to five years in jail and a \$1,000 fine)? In the past, the Secret Service has taken such threats very seriously. A check of the *New York Times* index shows that at least 11 people were arrested between January, 1972 and May 1973 for doing much less than Godfrey. Most seem to have been psychopaths or drunks, with no positive plan—just verbal threats.

But then there are other instances: Arthur Bremer's Ottawa visit on April 13-14, 1972, for example, when he supposedly stalked Nixon. On May 30, three bombs demolished the tomb of the father of the Shah of Iran an hour before Nixon was scheduled to lay a wreath there. On August 11, a certain A. B. Topping was arrested in New York after paying an undercover agent \$1,000 to kill Nixon. Topping, it developed, was well-to-do, of the American Nazi political persuasion, and interested in having the President killed the week after the pay-off. No trial has been held. And then in late May 1973, one of Nixon's helicopters went down in the Bahamas. It subsequently came out that the President has three helicopters ready at all times and chooses which to use one minute before the flight.

Watergate has uncovered an administration racked by factionalism. Under Hoover, the FBI was at odds with the White House—to such a

degree that Hoover was willing to use secret documents to blackmail the President. In addition, Nixon was having his difficulties with the leaders of the CIA, and James McCord wrote to John Caulfield at Christmas, 1972. that if Nixon pushed out Helms and involved the CIA in Watergate, "every tree in the forest will fall." Could there have been other tensions as well? Were there elements which opposed Nixon for his policy of rapprochement with China and Russia, and which would have preferred, say, Spiro Agnew as President?

After returning from San Diego in July 1972, acting FBI director, L. Patrick Gray, talked to Nixon and said: "Mr. President, there is something I want to speak to you about. Dick Walters and I feel that people on your staff are trying to mortally wound you by using the CIA and the FBI ..." His words may have carried greater import than any of us have heretofore suspected.

\* \* \*

*In August of this year, Godfrey reportedly admitted to the San Diego Door that there was a real plot to kill Nixon. He blames the plan on his erstwhile cohort, Gary Lynn Davis.*

(Mount Clipping in Space Below)

# Court Reverses Conviction

The Fourth District Court of Appeal has handed down a decision reversing the conviction of George Mitchell Hoover, 36, a key figure in the series of trials here involving alleged members of the right-wing paramilitary Secret Army Organization.

Hoover, formerly of San Diego, was sentenced to from five years to life in state prison last January, following his conviction in Superior Court on charges of assault with a deadly weapon, firing into an occupied dwelling and possession of a billy club.

The appeal court's decision sends the case back to Superior Court here, where a jury will weigh the question of whether the key prosecution witness was working as a "double agent," according to Richard Tyree, one of the attorneys involved in the

appeal, filed through Appellate Defenders, Inc.

The key prosecution witness was Howard Barry Godfrey, a former San Diego city fireman who was a paid FBI informant, assigned to infiltrate extremist right-wing groups.

Tyree said the main point emphasized in the appeal of Hoover's conviction is whether the jury should have been allowed to determine Godfrey's credibility, and if he was working as a "double agent" in concert with both the FBI and SAO, finally deciding to testify for the state to protect himself.

Superior Court Judge William T. Low, at the time of Hoover's trial, had ruled there was insufficient evidence to submit this question to the jury, Tyree said.

The charges against Hoover stemmed from the firing

of a bullet into the home of Peter Bohmer, then a former assistant professor at San Diego State University, on Jan. 6, 1972. The bullet struck a friend of Bohmer's, Paula Tharp, 23. Bohmer resided at 5155 Muir Ave., Ocean Beach, at the time.

Godfrey testified during the SAO trials here that Hoover shot into the Bohmer home. He said he was in

Hoover's car at the time. Justice Vincent A. Whelan of the Appeal Court said in a 16-page opinion that it was an error to refuse to give instructions to the jury to decide if Godfrey was an accomplice. Whelan said further that if a third person had seen the incident and called police, there would have been a strong possibility that Godfrey also would have been prosecuted if the car had been stopped.

(Indicate page, name of newspaper, city and state.)

Page B-2

SAN DIEGO UNION  
San Diego,  
California

Date: 10/31/73  
Edition: Home Edition  
Author:  
Editor: Gene Gregston  
Title: SECRET ARMY ORGANIZATION

Character:

or  
Classification: 157 - 2815  
Submitting Office: San Diego

Being Investigated

410

*Oct 31 1973*

UNITED STATES GOVERNMENT

# Memorandum

TO: SAC (157-2815)(P)

DATE: 9/27/73

FROM: SA EARL M. PETERSEN

SUBJECT: SECRET ARMY ORGANIZATION  
EM

The following individuals have been contacted to determine whether any SAO activity exists in San Diego at this time:

Les Oberlies, Detective Investigative Support Unit,  
San Diego Police Department 9/27/73.

INFORMANT

INFORMANT

INFORMANT

Howard Barry Godfrey, telephonic 9/18/73.

All of the above stated that there is no known SAO activity in San Diego at this time and that there has been none since the trials of members were completed.

LEAD:

Will expedite submission of LHM reflecting that SAO is dead and closing of this case.

EMP:emp  
(2)

157-2815-404

SEARCHED	INDEXED
SERIALIZED	FILED
SEP 27 1973	
FBI - SAN DIEGO	

*Peteresen*



Buy U.S. Savings Bonds Regularly on the Payroll Savings Plan

(Mount Clipping in Space Below)

# Appeal Filed In Conviction Of Secret Army Key Figure

An appeal has been filed with the Fourth District Appellate Court, challenging the 1972 conviction of William Francis Yakopec, a key figure in the Secret Army Organization trials. Yakopec, 31, was sentenced Oct. 24, 1972, to one year in state prison after his conviction on charges of assault with intent to commit murder, assault with a deadly weapon on a police officer, simple assault and possession of explosives.

The charges stemmed from an investigation of activities allegedly linked to the right-wing paramilitary Secret Army Organization, including the June 19, 1972 bombing of the Gaudin Theater, an adult movie house that showed sex-oriented films. No one was injured. Yakopec, just before his sentencing, made a dramatic confession, saying he had lied on

the witness stand when he depicted in four felonies, involving the setting off of an incendiary device in his yard, and possession and sale of illegal explosives. He said further that he had requested instructions from Superior Court Judge Robert W. Conyers, the trial judge, on entrapment, but his request was denied. Hetter added that Yakopec's case was one of entrapment.

On Yakopec's confession before sentencing, Hetter commented that it would be difficult to go to trial on the basis of a confession, and, if a new trial does develop, the defense would concentrate on the question of entrapment.

Yakopec was one of several persons indicted by the county grand jury in its investigation of Secret Army Organization activities. The series of trials that resulted captured wide public attention.

Hetter said Godfrey's reliability as a witness was open to question because he had participated in four felonies, involving the setting off of an incendiary device in his yard, and possession and sale of illegal explosives.

He said further that he had requested instructions from Superior Court Judge Robert W. Conyers, the trial judge, on entrapment, but his request was denied. Hetter added that Yakopec's case was one of entrapment.

On Yakopec's confession before sentencing, Hetter commented that it would be difficult to go to trial on the basis of a confession, and, if a new trial does develop, the defense would concentrate on the question of entrapment.

Yakopec was one of several persons indicted by the county grand jury in its investigation of Secret Army Organization activities. The series of trials that resulted captured wide public attention.

Hetter said Godfrey's reliability as a witness was open to question because he had participated in four felonies, involving the setting off of an incendiary device in his yard, and possession and sale of illegal explosives.

(Indicate page, name of newspaper, city and state.)

San Diego Union  
9/26/73

Date:  
Edition:  
Author:  
Editor:  
Title:

Character:  
or  
Classification:  
Submitting Office:

Being Investigated by S.I.S.  
157-2815  
157-286

SEARCHED ..... INDEXED .....  
SERIALIZED ..... FILED .....  
SEP 26 1973  
FBI - SAN DIEGO

*Handwritten notes:*  
Hetter copy  
made for  
157-2815 (SAO)  
170-286 (Hetter)  
EMJ



(Mount Clipping in Space Below)

# FBI FUNDS SECRET ARMY ORGANIZATION

SAN DIEGO (LNS) -- A leader of a right-wing paramilitary group responsible for several armed attacks on radicals here over the last year has stated that the group was partly organized and funded by an informer for the Federal Bureau of Investigation.

According to Jerry Lynn Davis, the former Southern California coordinator for the wellarmed Secret Army Organization (SAO), FBI informer Howard Berry Godfrey participated in a shooting and several fire bombings and burglaries, while receiving regular payments from the FBI.

According to Davis' account, the SAO was formed in 1971 to organize a "resistance movement", should the U.S. be conquered by a foreign power. Godfrey, the FBI informer, was one of the six founding members and contributed money used to print the group's recruiting literature. Davis also explained that Godfrey consistently took a "more militant line" than most of the members.

In court testimony, Godfrey admitted that he was riding in a car on January 6, 1972 when another SAO member fired a shot into a house occupied by radical organizing demonstrators for the Republican Convention which was originally scheduled to take place in San Diego. The bullet shattered the elbow of Paula Tharp.

Godfrey's role was first revealed, in part, last June when a member of the SAO was arrested for blowing up a theater that showed porno films. It was at this time that the San Diego police reportedly learned that the FBI had an informer in the SAO.

On the stand Godfrey admitted that he had supplied the explosives used in the bombing.

(Indicate page, name of newspaper, city and state.)

17 "THE EUGENE AUGUR"  
EUGENE, OREGON.

Date: 8/24/73  
Edition:  
Author:  
Editor:  
Title: "THE EUGENE AUGUR"  
NEW LEFT MOVEMENT - PUBLICAT  
Character: IS - REVACT

or  
Classification:  
Submitting Office: PORTLAND

Being Investigated

157-2815-402

SEARCHED INDEXED  
SERIALIZED FILED  
SEP 3 1973  
FBI SAN DIEGO

*Spread 6 date  
make copy  
for 157-3001  
af*

Of Godfrey's contribution to the SAO in time and money, Davis said, "you might say that the SAO was federally funded anti-poverty program for the right wing." Davis a 31 year old construction worker, told his story to a reporter after being released from jail where he was being held awaiting sentencing on a charge of possession of explosives.

According to The Door, Segretti came to San Diego in March 1972 and talked to a 30 year old student at San Diego State College, Ron Johnson. Johnson was asked to help out in preparation for the convention. He was asked if he had any longhaired friends who weren't doing anything. Specifically he was asked what he knew about radical professor Peter Bohmer and activist Paula Tharp.

"One thing Segretti said that stood out in my mind. He told me that if I located any trouble makers as the GOP convention approached, they could be gotten rid of. I asked him what he meant and he said, "they could be sent out of town for a limited time, Johnson told The Door.

UNITED STATES GOVERNMENT

# Memorandum

DATE: August 29, 1973

TO : SAC, SAN DIEGO

FROM : SAC, BALTIMORE (157-NEW) (P)

SUBJECT: S.A.O.  
EM - MM  
OO:SD

Re WFO letter to the Bureau, 7/5/73.

In referenced communication, WFO advised that on 6/13/73, informant obtained from Mrs. RAFAELA STEPHENS, widow of JESSE CLAYBURN STEPHENS, self-styled East Coast coordinator from Minutemen Organization, a copy of the name card file. This file was identified by Mrs. STEPHENS as a "Minutemen Registration" file, according to the informant.

WFO has concluded, after a review of the above file, that it contains the names of STEPHENS' Minutemen group together with his mailing list, contributors, and right wing contacts.

The name card file listed the following identifying data regarding the subject:

P.O. Box 5791  
San Diego, California 92105.

Investigation in this case is predicated upon the fact that subject's name was listed among well-known white extremists and is designed to conduct preliminary inquiries to identify subject and to contact sources to determine if subject is presently involved in white hate activities.

Baltimore indices regarding captioned subject negative.

San Diego need not furnish Baltimore results of investigation unless pertinent to this Division.

2 - San Diego (REGISTERED MAIL)  
2 - Baltimore  
RCG:rk  
(4)

157-2815-401  
SEARCHED  
SERIALIZED  
INDEXED  
FILED  
Pittman of

FBI

Date: 8/6/73

Transmit the following in \_\_\_\_\_  
(Type in plaintext or code)

Via AIRTEL AIR MAIL - REGISTERED  
(Priority)

TO: SAC, SAN DIEGO (157-2815)  
FROM: SAC, LOS ANGELES (157-7313) (RUC)  
SUBJECT: SECRET ARMY ORGANIZATION (SAO)  
EM  
OO: San Diego

Re San Diego airtel to Los Angeles dated 6/27/73.

The following confidential informants and sources have advised that there is no SAO in the Los Angeles area:

INFORMANT                      INFORMANT  
INFORMANT                      INFORMANT  
INFORMANT                      INFORMANT

San Diego's attention is also directed to Los Angeles letter and letterhead memorandum to the Bureau dated 8/16/72, wherein it was pointed out there was no SAO in the Los Angeles area.

2 - San Diego (AM-RM)  
1 - Los Angeles

LWS/cer  
(3)

157-2815-400  
SEARCHED \_\_\_\_\_ INDEXED \_\_\_\_\_  
SERIALIZED \_\_\_\_\_ FILED \_\_\_\_\_  
AUG 9 1973  
FBI - SAN DIEGO  
*Peterman*

Approved: \_\_\_\_\_ Sent \_\_\_\_\_ M Per \_\_\_\_\_  
Special Agent in Charge

Date prep  
12/4/72

Date received  
12/1/72

Received from (name or symbol number)  
INFORMANT

Received by  
SA LEROY W. SHEETS

Method of delivery (check appropriate blocks)

in person    by telephone    by mail    orally    recording device    written by Informant

Orally furnished and reduced to writing by Agent:  
Date

Date of Report  
11/27/72

Dictated \_\_\_\_\_ to \_\_\_\_\_

Date(s) of activity  
11/21/72

Transcribed \_\_\_\_\_

Authenticated by Informant \_\_\_\_\_

Brief description of activity or material

Info re meeting of Citizens Council  
of Los Angeles held 11/21/72 at  
Olympian Motel, Los Angeles.

File where original is located if not attached  
170-538A-2204

\* INDIVIDUALS DESIGNATED BY AN ASTERISK (\*) ONLY ATTENDED A MEETING AND DID NOT ACTIVELY PARTICIPATE. VIOLENCE OR REVOLUTIONARY ACTIVITIES WERE NOT DISCUSSED.

Information recorded on a card index by \_\_\_\_\_ on date \_\_\_\_\_

Remarks:

CC: 157-875 (JULIE HANNA)

157-5068 (MINUTEMAN)  
10-074834 (DICK ROGERS)

157-2815-399

- INDEX
- CITIZENS COUNCIL OF L.A.
- CALVIN FOX
- ROD DUFF
- BOB LYONS
- BERRY GODFREY
- SECRET ARMY ORG.
- McINTYRE
- MR. PITTMAN
- VA KOPIC
- TROY HAUGHTEN
- TACKWOOD

*Handwritten notes:*  
Make copies for  
30157 - (Calvin Fox)  
SD 157-2515 (SAC)

*Stamp:*  
SEARCHED INDEXED  
SERIALIZED FILED  
DEC 11 1972  
FBI - LOS ANGELES

*Handwritten signature:*  
L. W. Sheets

157-5068-85

LWS/DMB  
(3) DMB

Read by LWS

*Stamp:*  
SEARCHED INDEXED  
SERIALIZED FILED  
DEC 11 1972  
FBI - LOS ANGELES

SOURCE:

S-210

DATE & TIME:

November 21, 1972 2000 hours.

LOCATION:

Olympian Motel  
Los Angeles

SPONSOR:

Citizens Council of Los Angeles

PURPOSE:

Meeting to discuss the pending Perjury trial of Calvin Fox on 12-5-72 and Police Informants and FBI finks.

PERSONS IDENTIFIED:

Rod Duff - MC  
Calvin H. Fox - Speaker  
Julie Hanna - Gale's Church  
Bob Lyons - attending Gale's Church in Glendale regularly.

Calvin Fox runs a Gulf Service Station in ElCajon.

Fox stated that he was approached many times by Berry Godfrey who said he was Lt. Commander in the Secret Army Organization. He tried to sell Fox illegal weapons, etc. and invited him to join the S.A.O.

Berry Godfrey was a paid agent for the FBI for at least 5 years and was assigned to investigate Right-Wing Organizations.

Fox said that Godfrey hung around his station alot but that he did not join as he was doubtful of the organization.

In May, Fox went to Washington to march with McIntyre in the May 20th. protest, "To Win the War".

While he was away, FBI agents through an informer, Mr. Pittman working for Fox, went through various files without permission. Upon his return from Washington, Fox tried to discover why all the interest from the FBI. After many phone calls and many days he was told that since he was a former member of the Minutemen, invlved with the S.A.O, a known Wallace supporter, since Wallace was shot and Mr. Fox was not far from the area, that he was suspect and they were trying to get his license number to give to the Secret Service.

When Yakopic supposedly bombed the "sex theatre" he was again converged on by the FBI. Godfrey told them he was a member of the S.A.O. and the FBI had a copy of an application that he was to have filled out.

~~CONFIDENTIAL~~

He was a character witness for Yakopic but because of some "planted" evidence he will be tried for perjury.

During this time (right after the theatre bombing) Fox stated the FBI went to Troy Haughten's mother's home in La Mesa and did some extensive digging in the backyard and found nothing, they then left with no explanation.

Fox also made the comment that Tackwood, Los Angeles Police Dept. Undercover Agent, quit recently and stated he did so because, "I don't want to plant bombs and kill delegates to the convention to be held in San Diego". Tackwood has written a book called, "Glass House", soon to be released, it deals with that aspect of his life.

Fox feels the FBI and Godfrey are recruiting and pushing to involve right-wingers in illegal operations; along with the police department (bombing and laying the blame on the right-wing), were setting the stage for a riot so Marshall Law could be called and U.N. troops be called in.

In conclusion:

There were no real points made, or a moral or even much of a discussion dealing with ways to keep out infiltrators. They made a pitch for funds to help Fox pay for his Perjury trial (\$5,000.00).

Those in attendance seemed to enjoy the talk but nothing constructive came out of the meeting.

I also sensed that Rod Duff is trying to pull himself out of a slump or depression. When mentioning it to Julie Hanna, she agreed saying that her friend Lick Rogers has also stated same (he is a member).

He fell short as a leader in my opinion, as he asked the group what they would like to do and what type of meetings they wanted - he should have told them what he had going and got the people busy and active right then.

I asked him, after the meeting, what the dues were and did he do for the council or did the council do for him and the movement - he looked startled and replied, "I'm afraid right now I do for the council". - looks to me like he needs the up and coming seminar to put him back on his feet.

One other note - Fox feels like Yakopic was paid off as his wife seems to have a lot of money and a brand new car.

END OF REPORT

11-27-72

UNITED STATES GOVERNMENT

# Memorandum

TO : SAC, SAN DIEGO (157-2815) (P)

DATE: 7/17/73

FROM : SA DWIGHT G. GARRETSON

SUBJECT: SECRET ARMY ORGANIZATION  
(SAO)  
EM  
(OO: San Diego)

Re Memo of SAC REX I. SHRODER dated 7/6/73.

On 7/12/73, Mr. GREGORY MARSHALL, also known as EDWARD GUILBERT, 1612 Harbison Canyon Road, El Cajon, California, telephone number 445-2984, was interviewed at the San Diego Office of the Federal Bureau of Investigation.

MARSHALL advised that he does not have any specific information regarding the Secret Army Organization and is acquainted with only one person affiliated with the Secret Army Organization, that being RICHARD FLEURY, who is his next-door neighbor. He stated that the reason he had contacted the FBI was that on 6/1/73, his home had been burglarized and he had the following items stolen from him:

1. M-1 Rifle
2. NATO 762 Assault Rifle
3. Model 70 Shot Gun
4. M-3 Sniper Scope

MARSHALL also advised that on the day of the burglary, RICHARD FLEURY and another neighbor named EDWARD BEGLEY had come to his home, and in conversations with them after he had discovered the burglary, he had been

5-San Diego

(2-157-2815)

(1-157-3290) (RICHARD FLEURY)

(1-157-3289) (GENEVIEVE FLEURY)

(1-157-3001) (JERRY LYNN DAVIS)

DGG:vkw  
(5)

157-2815-393

SEARCHED	INDEXED
SERIALIZED	FILED
JUL 18 1973	
FBI-SAN DIEGO	



SD 157-2815

informed by them that they had discovered his gate open and his front door unlocked during the day time hours on June 1/, 1972. He further advised that in one of the Secret Army Organization trials, HOWARD BARRY GODFREY had testified that JERRY LYNN DAVIS had known about the weapons stolen from MARSHALL. MARSHALL could not recall whether GODFREY had testified that he had actually at the time seen these weapons or had testified that he had merely been informed of these weapons by DAVIS.

MARSHALL stated that he desired to know whether or not the FBI had any information regarding his weapons and his primary interest was to recover his weapons.

MARSHALL was advised that all information furnished by HOWARD BARRY GODFREY to the FBI regarding violations of local or state statutes had been disseminated to the appropriate local or state agency, and that he should contact the San Diego County Sheriff's Office as that agency would have jurisdiction over the burglary which occurred at his residence. He said he had been in contact with the San Diego County Sheriff's Office, and had been advised that his weapons had not been recovered and that the Sheriff's Office had no information regarding the whereabouts of these weapons.

MARSHALL further advised that he is aware of the location of the Gunsmoke Ranch, but does not frequent this location, and again advised that he has never met any of the persons affiliated with the Secret Army Organization except RICHARD FLEURY. He further advised that FLEURY has a considerable number of weapons at his residence, including shot guns, rifles, and automatic pistols. He has made statements to the effect that he will not again be taken alive. MARSHALL expressed his personal point that FLEURY is mentally unbalanced, and further advised that FLEURY is highly critical of all law enforcement in general, and of the FBI, in particular. He said FLEURY plans to file suit

SD 157-2815

against the San Diego, California, Police Department or the San Diego County Sheriff's Office for the return of weapons which were seized from him at the time of his arrest. He said that FLEURY also talks about going to South America and is highly critical of the United States Government in his conversations. MARSHALL further advised that GENEVIEVE FLEURY in conversation with other neighbors which have been related to MARSHALL, has indicated that she thinks her husband, RICHARD FLEURY, is planning to do something "out of the ordinary". MARSHALL said he did not know what she meant by out of the ordinary, and further advised that he has had no direct conversation with her, but has been hearing these rumors from other people, and he expressed the opinion that FLEURY's departure from the United States may be what these rumors refer to. He said that GENEVIEVE FLEURY has indicated to neighbors that RICHARD FLEURY thinks that she will accompany him to South America, but, in fact, she does not plan to go with him if he does leave this country.

MARSHALL advised that he is not on friendly terms with FLEURY, in that he somewhat suspects FLEURY of burglarizing his home, and he feels that FLEURY does not trust him. He said he would relay any information regarding FLEURY's activities to this office, but said that because of his relationship with FLEURY, he would not be in a position to actively seek information regarding FLEURY's plans.

UNITED STATES GOVERNMENT

# Memorandum

TO : SAC, SAN DIEGO (157-2815)

DATE: 7/13/73

FROM : SA DWIGHT G. GARRETSON

SUBJECT: SECRET ARMY ORGANIZATION  
EM

Review of pertinent files reveals the following information:

Information regarding shooting of PAULA THARP by GEORGE MITCHELL HOOVER was originally furnished to SA STEVEN LEE CHRISTENSEN by HOWARD BARRY GODFREY on 1/12/72. The shooting had occurred on 1/6/72. See memo of SA CHRISTENSEN dated 1/13/72 and San Diego Nitel to Bureau 1/13/73 (170-286-90 and 157-3017-20).

The information regarding this shooting was furnished to CAPTAIN KENNETH O'BRIEN, SDPD by SAs CHRISTENSEN and EARL M. PETERSEN on 1/13/73. See San Diego Nitel to Bureau 1/14/73 (170-286-88 and 157-3017-19).

~~2 - 157-2815~~  
1 - 157-3017  
1 - 170-286  
(4)  
DGG:

157-2815-391

SEARCHED	INDEXED
SERIALIZED	FILED
JUL 13 1973	
FBI—SAN DIEGO	
11/13	

UNITED STATES GOVERNMENT

# Memorandum

TO : FILE (157-2815)

DATE:

FROM : SAC REX I. SHRODER

SUBJECT: GREGORY MARSHALL  
SECRET ARMY ORGANIZATION

Captioned individual who resides at 1612 Harbison Canyon, telephone number 445-2984, called today and indicated he would like to speak to an agent knowledgeable in the SAO organization.

He said that he resides near where some SAO members live and that his residence was burglarized some time ago and some weapons were stolen. He is primarily interested in furnishing information which may be of interest concerning the SAO and the disposition of some of the stolen weapons.

I told him that we would have an agent contact him on Monday, July 9, 1973, and arrange a convenient time for subsequent interview.

San Diego indices show a GREG MARSHALL - 157-3290-3.

RIS:mah  
(2)

*Maloney*  
*Revised PD*

*Garrettson advised. DJ*

*Contacted 7/9/73 & app't. set for 7/12/73*

157-2815-390

SEARCHED	INDEXED
SERIALIZED	FILED
JUL 9 1973	

*Garrettson*



SAC, SAN DIEGO (157-1816) (P)

W/W/73

SA DWIGHT G. GARRESON

JAMES EVAN POTO  
EM - SAO  
(OO: San Diego)

Attached to each copy of this memo is a copy of an FD-302 containing results of interview of subject. This FD-302 is being disseminated to the indicated files because subject furnished information regarding the subjects of these files.

- 2 - 157-1816
- 1 - 157-3001 (DAVIS)
- 1 - 157-3388 (BOYLE)
- 1 - 157-1614 (TROY HAUGHTON)
- ① - 157-2815 (SAO)
- 1 - 157-1798 (Minutemen)

DGG:blp *blp*  
(7)

*OP*  
*A*

157-2815-326

SEARCHED _____	INDEXED _____
SERIALIZED _____	FILED _____
APR 6 1973	
FBI - SAN DIEGO	
118	

## FEDERAL BUREAU OF INVESTIGATION

Date of transcription April 3, 1973

JAMES EVAN FOTO, 3496 Olga Street, San Diego, California, was interviewed at the San Diego Office of the Federal Bureau of Investigation. He was informed of the jurisdiction of the FBI in the field of Internal Security.

POTO advised that he had formerly been associated with both the Minutemen Organization and the Secret Army Organization. He explained that approximately eight or nine years ago he had become acquainted with JERRY LYNN DAVIS who was known to him as SAM DAVIS. He said he had met DAVIS at various gun shops and swap meets in the San Diego area, explaining that both he and DAVIS had been interested in firearms. He also advised that at about that same time he had purchased a home in La Mesa, California, through VAHL BOYLE who worked as a Realtor in that area. Through her he had met her son TROY HAUGHTON, who was also acquainted with SAM DAVIS. He continued that through DAVIS and HAUGHTON he had become interested in the Minutemen Organization and had participated in activities of this organization including literature distribution and marches and demonstrations against "Leftist" groups and individuals.

POTO stated that he had never actually been a member of the Minutemen Organization but admitted that he might have submitted an application for membership and stated that he did not recall specifically whether or not he had applied for membership and whether or not he had been accepted as a member.

POTO continued that during the later part of 1967 he had moved from the San Diego area to Phoenix, Arizona, and through the Minutemen Organization in San Diego had been placed in contact with one EV MOORE described as a Minuteman Leader in Phoenix. He said he had met MOORE but had not participated in any Minutemen functions in Phoenix.

POTO advised that he had been acquainted with TROY HAUGHTON and said he had no information regarding the disappearance of HAUGHTON. He related that he had heard rumors that HAUGHTON had been killed by ROBERT DE PUEH. He did not know the original source of any of these rumors but said that they were related to him by JERRY LYNN DAVIS,

Interviewed on 3/29/73 at San Diego, California File # SD 157-1816  
 by SA JOHN O. TREHNEY, JR.  
SA DWIGHT G. GARRETSOHN/blb Date dictated 4/3/73

This document contains neither recommendations nor conclusions of the FBI. It is the property of the FBI and is loaned to your agency; it and its contents are not to be distributed outside your agency.

and to his knowledge these rumors were based on conjecture with no basis in fact. He reiterated that he had no first hand knowledge of what happened to TROY HAUGHTON.

POTO continued that he had returned to the San Diego area sometime during the fall of 1970, and upon his return to San Diego had renewed his acquaintanceship with JERRY LYNN DAVIS. He said that sometime over a year ago, exact date not recalled, he had been invited by DAVIS to join a new organization being formed by DAVIS by the name of Secret Army Organization, which DAVIS said was to be the "Refined Version of the Minutemen." POTO stated that he had declined this invitation to join because he did not have time to participate in any such activities because of his business.

POTO advised that he had met BARRY GODFREY on three or four occasions at DAVIS' home and had also met MICKEY HOOVER during target practice sessions which he had had with DAVIS. He said he was not acquainted with FRANK YAKOPIC or with any other individual known to or rumored to be affiliated with the Secret Army Organization.

POTO described himself as a right wing conservative as far as politics were concerned and stated he is opposed to the use of firearms in any form, and for this reason did not condone the activities of the Secret Army Organization.

POTO said he had no information regarding illegal weapons or explosives in the possession of any of his associates, except that he had seen a small amount of fuse at DAVIS' home.

POTO further advised that over the period of the past nine years, he had contributed money only to the Minutemen Organization, to TROY HAUGHTON, and also to JERRY LYNN DAVIS. He said he did not give any money to the Secret Army Organization but had given money to DAVIS to assist in DAVIS' defense after DAVIS had been arrested. POTO related when he had been affiliated with the Minutemen Organization, all communications and correspondence to him from the Minutemen had originated in San Diego. He assumed that it had been mailed by TROY HAUGHTON. He said he had never had any contact with the National Headquarters or the National Leaders of the Minutemen.

<sup>3</sup>  
SD 157-1816

POTO commented that he occasionally carries a revolver and gave the reason as for protection because he often carries large sums of money in connection with his employment.

POTO provided the following description of himself:

Race	White
Sex	Male
Date of Birth	September 6, 1941
Place of Birth	Hammond, Indiana
Height	5' 10"
Weight	180
Hair	Brown
Eyes	Hazel
	Wears Glasses
Arrest Record	None
Social Security Account Number	<span style="border: 1px solid black; padding: 2px;">JFK Act 6 (3)</span>
Employment	Manager Reubens Restaurant Grossmont Shopping Center La Mesa, California
Military Service	None
Marital Status	Divorced from PAMELA SHELDON, who has since remarried and now resides in Kansas City, Kansas.
Education	Attended Indiana University and San Diego State College but received no degree from either institution.
Parents	EUGENE and RUTH POTO Exact address unrecalled Echo Court La Mesa, California
Former Residence	Royal Palm Road Phoenix, Arizona 1967 - 1970
Telephone Number	292-0176



February 5, 1973

Honorable Louis L. Hicks  
Apartment 221  
8401 North New Braunfels  
San Antonio, Texas 78209

Dear Judge Hicks:

I have received your letter of January 26th, with enclosures, and appreciate your bringing this information to my attention. I am pleased to enclose a copy of my remarks of January 25th before the National Conference on Criminal Justice in Washington, D. C.

Sincerely yours

*L. Patrick Gray III*

L. Patrick Gray, III  
Acting Director

Enclosure

- ① - San Diego - Enclosures (3)
- 1 - San Antonio - Enclosures (3)

157-2815-357  
SEARCHED INDEXED  
SERIALIZED FILED  
FEB 17 1973  
FBI - SAN ANTONIO  
*[Signature]*

*Malsney A*  
*Petersen G*

LOUIS L. HICKS  
2401 NORTH NEW BRAUNFELS  
SAN ANTONIO, TEXAS 78206  
APT. 221

Jan. 26 1973

L. Patrick Gray III  
Federal Bureau of Inv.  
Department of Justice  
Washington D.C. 20535  
Dear Director;-

I have just heard the very sensible and well timed remarks of your brief appearance on Channel 13 this morning (T.V.). Your predecessor used to send me some of his speeches. If you have a copy available I would like to read the complete statement.

Incidentally I have asked my "Washington Observer" friends in California to lay off the F.B.I. (Howard Godfrey) and get rid of some of their quack economists.

I have also advised them that I am not in sympathy with their "Tax Strike". Every American should obey the law whether he likes it or not, and I do not belong to the John Birch Society.

I enclose the front page of Jan. 1 1973 issue. (Xerox) because I understand every Senator and Congressman gets a copy.

Yours for confirmation,  
(Judge) Louis L. Hicks.

*Louis L. Hicks*

157-2815-356

SEARCHED	INDEXED
SERIALIZED	FILED
FEB. 7 1973	
FBI - SAN DIEGO	

*Peterson*

# WASHINGTON OBSERVER

## NEWSLETTER

"What country can preserve its liberties, if its rulers are not warned from time to time that the people preserve the spirit of resistance?" —THOMAS JEFFERSON

NUMBER 151

JANUARY 1, 1973

**LYNCH PARTIES** Evidence is accumulating that if you are Jewish or Negro, you can break the law with impunity, but if you are White and a patriot, you are a second-class citizen. There is a growing double standard of justice in the U.S.—harsh punishment for patriots (secured by the perjury of federal agents) and leniency for the Left.

Last month saw two outrageous miscarriages of justice in San Diego. On December 21, ten tax protestors were declared "guilty" of "conspiracy to rescue seized property" by a jury which followed the promptings of a federal judge.

Judge Leland C. Nielsen clearly had received orders from higher-ups to convict the ten defendants, no matter what he had to do. He showed open contempt for the rights of the accused, refusing even to recognize that the Heck Warehouse—the focus of the picketing that led federal agents to physically assault the patriots and arrest them on trumped-up charges—had not even been legally seized by the IRS until the day after the arrest of the defendants!

The federal agents involved perjured themselves on the witness stand but the jury (composed in large part of bureaucrats and others whose salaries are paid for by taxes) refused to believe that FBI and Treasury agents would act in the criminal manner they did and then lie under oath.

Although prosecution testimony was inconsistent, distorted and contradictory, Nielson brusquely dismissed defense motions and objections and upheld the prosecution throughout.

The other lynching bee in San Diego concerned two men who were admittedly entrapped by undercover FBI agent-provocateur Howard Godfrey.

Undisputed are the facts that Godfrey incited William F. Yakopec into bombing a porno movie house, and even supplied the dynamite.

Yakopec was convicted of the bombing on Godfrey's testimony. A witness for Yakopec, Calvin H. Fox, was subsequently convicted of perjury on Godfrey's testimony, although the evidence clearly indicated that Fox was telling the truth

Contributions for the "San Diego Ten" appeal may be sent to *The Educator*, Box 333, Fullerton, Calif. Send contributions for Fox's appeal to L.A. Citizens Council, Box 146, Arcadia, Ca. 91003.

1972

REVIEW

In retrospect 1972 was a precedent-shattering year in America's international relations. President Nixon abruptly reversed his previous anti-Communist stance. The machinations of his foreign policy mentor, Dr. Henry A. Kissinger, resulted in a detente with Peking and Moscow, which was enthusiastically supported by the "liberal" news media and paved the way for Nixon's highly publicized trips to Red China and Soviet Russia. The general public, bemused and confused by an avalanche of promotional publicity featuring world peace as the ultimate goal, was cajoled into accepting the bland assurances of the Kissinger-Nixon team. WO readers had been forewarned about the Nixon-Kissinger scheme of Soviet-American convergence as the first step in the Grand Design of One World Government.

In reviewing the many exclusive news items of WASHINGTON OBSERVER in the course of 1972 it will be noticed that on March 15, 1972, WO exclusively reported that Nixon's bagman and political mastermind, Murray M. Chotiner, was surreptitiously channelling funds to the pro-Communist People's Party. The purpose of the operation was to draw left-wing votes from Democrat candidates. This was the first reported act of sabotage against the Democrats.

On May 1, 1972, WO exclusively reported: "... In his desire to run as the 'Peace President' in November 1972, President Nixon has let the Kremlin leaders know that he is ready to grant them—and help them assert—suzerain rights in all Western Europe, as well as in Germany and in the Soviet-occupied countries of Central and Eastern Europe." The current conference on European security in Helsinki and the moves afoot to recognize the Soviet puppet regime of East Germany as a sovereign government doom the hopes of the reunification of Germany which were raised by the solemn pledges of the United States, Great Britain and France at the time of the founding of the North Atlantic Treaty Organization (NATO). WO exclusively predicted that Nixon, ... would agree to ...

On May 15, 1972, WO exclusively forecast: "As President Nixon departs for Moscow, one of the goodies he takes for Chairman Leonid Brezhnev

**Editor:**

As a new subscriber to THE AMERICAN MERCURY please allow me to inform you how much I enjoyed the Summer, 1972 issue. I am taking advantage of your order blank to order back issues of this marvelous magazine. What a shame you are prohibited from newsstand sales. How pitiful that more people are not aware of your magazine. Of course, the most pitiful thing of all is that the working, middle-class citizen of this "once-great" America of ours, feels so helpless.

As a new subscriber I want to express my heartfelt appreciation for your attempt to wake up the citizens of these United States. You and Liberty Lobby are doing a great service, and I only wish that I were financially able to really be of help.

JOY D. GREEN  
South Gate, Calif.

**Editor:**

Does Mr. Buckley get his anti-toxin shots from ADL? He seems to be immune from character assassination. Senators Goldwater, the late Robert A. Taft, Sr., Joe McCarthy, Gen. MacArthur, Gov. Wallace, and patriotic groups including LIBERTY LOBBY never escape the poison pen of ADL. So maybe perfidy and duplicity is not so foreign to his political stance. At any rate, WASHINGTON OBSERVER NEWSLETTER has about convinced me. At least, Mr. Buckley's conservatism doesn't go beyond the point of: "Hang your clothes on a hickory limb, but don't go near the water."

H. J. WILLIAMS  
Madison, Ohio

**Editor:**

One of the most frequent complaints heard around election time is "there's no real choice; you just have to pick the lesser of two evils."

How often does it occur to us that the lesser of two evils is still evil? And that's the whole point: The present election system doesn't really give us a choice. In many cases, "there ain't a dime's worth of difference" between the Democrat and Republican candidates.

What we need is one more position on the ballot for each elective office. We need a block labelled "NONE OF THE ABOVE" so we can reject ALL of the "me-too" candidates who offer us no real choice.

For more information on protesting against the present election system and appropriate bumper stickers, write:

League of Non-Voters  
Box 1406  
Santa Ana, Calif. 92702  
DAVID MICHAEL MYERS  
La Plata, Maryland

WINTER, 1972

**Editor:**

Enclosed please find a check in the amount of seven dollars for which I would like you to send my twenty (20) copies of the Tax Strike Issue of THE AMERICAN MERCURY.

I am glad that you have had the courage to publish this issue and I hope that you will keep right on in this matter. It is long overdue. I feel that this is the only way left to us to overcome this conspiracy to destroy us and our country. This action, as I see it, is *Constitutional*.

We are cowards if we do not act. I am seventy-two years of age, am self-employed, and do not have a socialistic security number. I stand on my own feet.

Please give me all the information you can.

A. B. MARTIN  
Ellenton, Florida

**Editor:**

Your articles in AMERICAN MERCURY have been very interesting although those on "The Economy" and "The Money Supply" are partially hogwash. I don't object when a writer expresses his opinion even though different from mine, but when you make a statement in your Newsletter which is in error (#145, Sept. 15th, 1972, last page) quote, "for every dollar . . . the national debt which has been manufactured by bookkeeping entry," you are in error. The real truth is that the entry is not *manufactured* but is very real.

The process is that the U.S. Treasurer has a supply of unsigned engraved U.S. Government Bonds which when the Fed "buys bonds" are taken to the U.S. Treasurer who signs them, returns them and then the Fed "buys" them by running off on a printing press an equivalent amount of fiat paper labelled "Treasury Notes" such as used by the public. These notes are no longer "redeemable in lawful money of the U.S." as they used to be because there is none. Only a relatively small amount of illegally debased coinage. These notes have no value being merely paper with ink on them.

Meanwhile, the American Public pays interest on the U.S. Government Bonds to the tune of over \$15,000,000,000 (Fifteen Billion Dollars) every year.

That certainly is not a manufactured book-keeping entry. The Treasury notes are phoney but the Bonds in possession of the Fed are very real, also the interest as it comes due.

LOUIS L. HICKS  
Houston, Texas

65

2/2/73

A I R T E L

TO: ACTING DIRECTOR, FBI (157-26763)

FROM: SAC, SAN DIEGO (157-1820)(C)

SUBJECT: WILLIAM FRANCIS YAKOPEC  
EM - SAO  
(OO: San Diego)

Re San Diego airtel and LHM to Bureau, 11/1/72.

Enclosed for the Bureau are five (5) copies of an LHM r<sup>e</sup>garding captioned subject.

One (1) copy of the enclosed LHM has been disseminated locally to the United States Secret Service, inasmuch as the Secret Army Organization (SAO), and its members, present a potential for violence.

Two (2) copies of an FD 376 are attached to the Bureau copies.

Subject is not being recommended for the ADEX in view of his conviction and long prison sentence.

2 - Bureau (Enc. 5)(RM)

③ - San Diego

(2 - 157-1820)

(1 - 157-2815)

EMP/lpo

(5)



157-2815-355

SEARCHED INDEXED  
SERIALIZED FILED

San Diego, California

February 2, 1973

WILLIAM FRANCIS YAKOPEC

On October 2, 1972, William Francis Yakopec, an alleged member of the Secret Army Organization (SAO), was found guilty in Superior Court of the County of San Diego on charges of igniting and exploding a destructive device; assault with intent to commit murder; simple assault; assault with a deadly weapon on a police officer, and possession of explosives near a habitation. The charge of attempted murder resulted from the bombing of the Guild Theatre, 3827 Fifth Avenue, San Diego, California, on June 19, 1972.

The Secret Army Organization (SAO) is an anti-Communist, paramilitary organization formed in 1971 in San Diego, California. It intends to conduct intelligence type operations and to offer training in urban guerrilla warfare to be used against "left wing groups" and suspected enemies of the United States.

On October 24, 1972, Larry Wilson, District Attorney's Office, San Diego County, advised that William Francis Yakopec was sentenced on October 24, 1972, to one year to life for assault with a deadly weapon on a police officer and to four other sentences of one to five years to run concurrently on other charges which included assault with intent to commit murder; igniting and exploding a destructive device; possession of other than fixed ammunition; and possession of explosives in or near a place of habitation.

(9)  
EMP/lpo (157-2815)

-----  
This document contains neither recommendations nor conclusions of the FBI. It is the property of the FBI and is loaned to your agency; it and its contents are not to be distributed outside your agency.

157-2815-35  
SEARCHED INDEXED  
FILED

WILLIAM FRANCIS YAKOPEC

On November 3, 1972, Yakopec entered a plea of guilty to a lesser charge of possession of inflammable material with intent to burn, before San Diego County Superior Court Judge Gilbert Harelson. He was sentenced to another term of one to five years in the State Prison to run concurrently with the one to life sentence he had previously received. The charge of possession of inflammable material resulted from a follow-up search of his rented home in El Cajon, California, on August 9, 1972. As a result of this search Yakopec was originally charged with possession of explosives. His wife, Deborah Yakopec, age 26, had been arrested on the same charge but was allowed to enter a plea of no contest to a lesser charge of disturbing the peace and was fined \$20 by Judge Harelson.

Investigator Wilson reported that Yakopec was sent to the California State Penal Institution at Chino, California, for a period of observation for 120 days, after which he could be recalled and consideration could be given to a change of sentence.

On January 24, 1973, Investigator Wilson reported that the period of observation for Yakopec at Chino, California, had been terminated and on recommendation by the Court he has been transferred to Vacaville Prison, Vacaville, California, to begin serving the sentence prescribed by law.

Date 11/27/72

PAUL ERWIN RUPLINGER was interviewed at his home at 4567 Massachusetts Street, San Diego, California. He was advised of the identity of the interviewing agents and the purpose of the interview. He furnished the following information:

He denied ever having been a member of the Secret Army Organization (SAO) but has known HOWARD GODFREY for four or five years. He said he was surprised when he learned that GODFREY had been an informant for the FBI for the entire period that he has known him. He once met JERRY LYNN DAVIS through GODFREY. DAVIS was introduced to him as "SAM." He was aware that GODFREY and SAM were involved with the SAO. He denied knowing SY ANDERSON of Seattle, Washington or that he was involved in furnishing guns, ammunition and explosives to SAO members.

RUPLINGER has from time to time given sums of money to GODFREY for use in financing bulletins printed and distributed by the SAO. He furnished this money because of an interest in "survival." At one time he was shown a poster printed on 8 $\frac{1}{2}$ " x 11" paper containing a resume of information extracted from newspapers regarding President NIXON. Later when this poster was printed and distributed, he was surprised to see that it was printed on 8 $\frac{1}{2}$ " x 13" paper, contained a photograph of President NIXON and indicated that he was wanted.

RUPLINGER said his only interest in the SAO was the organization's contribution to "survival." He said he has always had an interest in this matter and has written many pamphlets over the years dealing with this subject. He was at one time a "Survival Consultant." His latest effort in the field of survival was to mastermind an organization called "Virtues in America." He said he had help in setting up the organization but that it failed because of lack of interest. The organization was only interested in pushing survival activity. He would like to reorganize this organization. If he is able to do so he will advise the FBI of his progress and will furnish copies of any literature distributed by him.

On 11/22/72 at San Diego, California File # 157-2815-333  
157-3226  
 by SAs DWIGHT G. CARRETERON and  
EARL H. PETERSON:emp Date dictated 11/27/72



He stated that he is acquainted with General WILLIAM LEMLY, 1536 Glorietta Place, Coronado, California. He met him in connection with an organization called the "Liberty Amendment Committee." This was a movement started by one WILLIS STONE to change or completely eliminate the 16th Amendment to the Constitution. This would eliminate the income tax in the United States. Another goal of the organization was to get the U. S. Government out of all the businesses it runs at a loss.

RUPLINGER stated that he has never been a member of the Minutemen Organization. He met TROY HAUGHTON, the leader of this group twice in 1965 or 1966. The first time he met HAUGHTON, he got into an argument with him when he told him that the Minutemen Organization was inconsistent. He denied knowing anything about the disappearance of HAUGHTON.

RUPLINGER stated that he is not involved in any activity against the best interest of the United States and does not intend to get involved in such activity. He said he does not have in his possession explosives or illegal weapons.

SAC, SAN DIEGO (157-2921) (C)

1/19/73

SA DWIGHT G. GARRETSON

~~INFORMANT~~

EM - SAO  
(OO: San Diego)

Re memo of SA DWIGHT G. GARRETSON dated 11/24/72.

On 11/27/72, SA CLAYTON WOLF, Bureau of Alcohol, Tobacco, and Firearms (ATF), San Diego, California, advised that his agency does not currently have a pending investigation regarding the subject. WOLF further advised that an interview of the subject by this Bureau would not interfere with any investigation of ATF.

On 1/15/73, subject was interviewed by SAs DWIGHT G. GARRETSON and EARL H. PETERSEN. He stated that he had never been a member of the Secret Army Organization (SAO), although he had been acquainted with HOWARD GODFREY and TOM FORREST. He also stated that he knew WILLIAM YAKOPEC by sight, but was not personally acquainted with him. He did not know GEORGE MITCHELL HOOVER.

~~INFORMANT~~

~~INFORMANT~~ stated that he knew of the existence of the SAO through HOWARD GODFREY, but had never known of any of the activities of this group, and no one had approached him to join this group. He said he did not know JERRY LYNN DAVIS, the leader of this group, although he might have met him, as he is acquainted with various associates of DAVIS.

~~INFORMANT~~

~~INFORMANT~~ continued that in the past he had frequented gun shops, gun shows, and gun swap meets, and had frequently bought, sold, and traded guns, gun parts, and ammunition. He stated that he had never dealt in explosives and had never had possession of any explosives. He commented that he might have stated to different individuals that he could get explosives, but explained that any such comments by him would have been for the purpose of keeping the people interested as a prospective customer of his guns, gun parts, or ammunition.

- 1 - 157-2921 ~~INFORMANT~~  
2 - 170-NEW ~~INFORMANT~~  
1 - 157-2177 (FORREST)  
1 - 157- (WILLIAM FRANCIS YAKOPEC)  
1 - 157-2315 (SAO)

DGG:clb  
(C)

157-2815-352  
NS mr  
Peter J.

*INFORMANT*

~~INFORMANT~~ denied ever having had possession of a large quantity of ammunition and said he had never had possession of an M-2 conversion kit, although this was possible as he often bought gun parts in large quantities without even knowing what all was contained in the purchase.

*INFORMANT*

~~INFORMANT~~ stated that he had known an individual named CY ANDERSON approximately two to three years ago. He explained that ANDERSON would come to San Diego frequently and would visit with *INFORMANT IDENTIFIED*

the San Diego area. He said that ANDERSON would buy guns and ammunition in the San Diego area for resale by him in the state of Washington, where he operated a hunting shop.

*INFORMANT*

~~INFORMANT~~ was cooperative during this interview and stated that he would be willing to assist this Bureau by furnishing any information which might come to his attention. He was advised of the jurisdiction of the FBI.

As ~~SE~~ subject was not a member of SAO or any other extremist organization, this case should be closed.

In view of subject's cooperative attitude, and as he is acquainted with various extremist subjects, it is recommended that a new I79 case be opened and efforts will be made to develop subject as an ~~urban informant~~. *PEI*.

The following is descriptive data regarding this subject:

*INFORMANT  
IDENTITY*

SD 167-2921

INFORMANT  
IDENTITY

- 3 -

FBI

Date: 12/13/72

Transmit the following in \_\_\_\_\_  
(Type in plaintext or code)

Via AIRTEL \_\_\_\_\_  
(Priority)

TO: ACTING DIRECTOR, FBI  
FROM: SAC, SACRAMENTO (175-55) (P)  
SUBJECT: FRANCIS EARL GILLINGS  
ALLEGED PLOT TO KILL THE  
PRESIDENT - CONSPIRACY  
OO: Sacramento

Re Sacramento letter and LHM, 11/21/72, entitled, "JAMES WALTER SCOTT, EM - WIG, OO: Sacramento"; Sacramento airtel and LHM, 11/21/72, entitled, "TAX REBELLION COMMITTEE, EM - WIG, OO: Sacramento"; Sacramento nitel to the Bureau,

- 4 - Bureau
  - (2 - 175- ) (FRANCIS EARL GILLINGS)
  - (1 - 175-23577)
  - (1 - 157-21670)
- 2 - Albuquerque (Enc. 3)
- 2 - Chicago (Enc. 3)
- 2 - Detroit (Enc. 3)
- 2 - Kansas City (Enc. 3)
- 3 - Los Angeles (Enc. 2)
- 2 - Mobile (Enc. 3)
- 3 - Phoenix (Enc. 2)
- 2 - Portland (Enc. 3)
- ③ - San Diego (157-2815) (Enc. 2)
- 2 - San Francisco (Enc. 3)
- 9 - Sacramento
  - (2 - 175-55) (1 - 157-2552)
  - (1 - 157-1947) (1 - 157-2569)
  - (1 - 157-2195) (1 - 170-304)
  - (1 - 157-2493) (1 - MKBA) (DEAD)

TRK:Kjt  
(36)

*CCO make Xerox 157-3579*  
*agg/n 157-3579*

157-2815-332

SEARCHED INDEXED  
SERIALIZED FILED  
DEC 14 1972  
FBI - SACRAMENTO

*Peterman*

SC 175-55

12/4/72; and Bureau airtel to Sacramento, 12/7/72, captioned, "SECRET ARMY ORGANIZATION (SAO), SACRAMENTO DIVISION, EM" and "TAX REBELLION COMMITTEE (TRC), EM - WHG".

Enclosed for Albuquerque, Chicago, Detroit, Kansas City, Mobile, Portland, and San Francisco is one copy each of referenced Sacramento communications.

Enclosed for San Diego is one copy each of Sacramento letter and LHM, airtel and LHM, both dated 11/21/72.

Enclosed for Los Angeles is one copy each of Sacramento airtel and LHM, 11/21/72, and nitel, 12/4/72.

Enclosed for Phoenix is one copy each of letter and LHM, dated 11/21/72 and nitel, 12/4/72.

On 12/5/72, the Bureau advised that information contained in Sacramento nitel to the Bureau, 12/4/72, indicated a possible violation of the assaulting the President of the United States statute and advised Sacramento to immediately institute appropriate investigation in this matter.

By referenced Bureau airtel to Sacramento, 12/7/72, Sacramento was instructed to conduct necessary investigation to determine the extent of the Secret Army Organization's (SAO) presence in this division and comment on its relationship to the Tax Rebellion Committee (TRC).

In addition, the Bureau advised that in view of the extremist remarks of individuals associated with the TRC, preliminary investigation was to be conducted to determine the extent of the TRC's membership's involvement in white extremist activity and other violations within the jurisdiction of the FBI. The Bureau advised that Sacramento was to maintain contact with established sources and informants for

information regarding the TRC in the above regards but to make certain not to interfere with pending prosecution against JAMES WALTER SCOTT, National Chairman of the TRC, or infringe upon investigative responsibilities of the Internal Revenue Service or other agencies.

In addition, the Bureau has advised that results of investigations of the SAO and TRC are to be submitted in a form suitable for dissemination under respective captioned cases.

In a letter captioned Tax Rebellion Committee, contained in referenced Sacramento airtel and LHM to the Bureau, dated 11/21/72, the leadership of the TRC is set forth. All offices are to review this letter for individuals listed within their territory.

On 12/5/72, <sup>INFORMANT</sup> advised a meeting was held 12/5/72 at Fresno, California, by a group of persons who do not go by a specific name but who are very anti-Jewish and anti-Negro as well as a tax rebellion group. There were about fifty persons in attendance at this meeting and the speaker was Reverend GAIL from the Los Angeles area.

Source stated that GAIL's speech was extremely anti-Negro and Jew and that he (GAIL) claimed they had to get tough with all the Jewish communists who run congress. GAIL said that this country has to be cleaned up and the only way to accomplish this would be to kill every FBI Agent and every IRS Agent. GAIL further stated that the FBI and IRS Agents should not only be killed but also hung from every telephone pole and mutilated.

Source further related that PAUL TODD claimed he was director of a chapter of the National Association to Keep and Bear Arms (NAKBA), and he lives at P. O. Box 147, Madera, California. TODD further claimed that JIM SCOTT had

SC 175-55

connections in many of the MKBA groups. TODD went on to state that his organization had to be very careful with what they did so that they would not be thought of as the "Secret Army Organization" because some of the people in this organization were radical and thought like the SAC.

Source advised that TODD said all of these organizations like SCOTT's, TRC, the MKBA, and the SAO had to stay in an informal connection with each other so that when the big revolt came, they could all unite; but they should not be too closely united yet or they would be caught and thrown in jail.

On 12/5/72, Lieutenant CLOYCE BROOKSHIRE, Tracy Police Department, advised his files reflect that FRANCIS GILLINGS was arrested 12/6/61 by the Marysville Sheriff's Office, Marysville, California, number A18833, for petty theft and received one year probation.

BROCKSHIRE further advised that his records reflect that GILLINGS has purchased four weapons which include a .32 automatic, a .38 revolver, a .22 revolver, and a .22 automatic.

On 12/7/72, Sergeant KENNETH WAGNER, Intelligence Division, San Joaquin County Sheriff's Office (SJSO), advised his files contain no arrest record for subject; however, his department has contacted GILLINGS on several occasions in regards to GILLINGS confronting his customers with a revolver when he thought they were trying to cheat him. WAGNER advised his intelligence records indicate GILLINGS operates an Arco gas station at U. S. 580 and Patterson Pass Road, Tracy, California, and that he moved to Tracy in 1962 from South Dakota. GILLINGS is married, has four sons, who attend local Tracy schools, and he ran for State Assembly on the American Independent Party ticket.

WAGNER advised that his files indicate subject is "ultra-right wing" and they consider him to be potentially dangerous.



SC 175-55

The following is a description of FRANCIS EARL GILLINGS:

Race: Caucasian  
Sex: Male  
Date of birth: 7/27/31  
Place of birth: Academy, South Dakota  
Height: 6' 3"  
Weight: 180 pounds  
Eyes: Brown  
Hair: Brown  
Social Security Number: JFK Act 6 (3)  
Address: 1826 East Street  
Tracy, California  
California driver's license number: H337723

On 12/8/72, ~~INFORMANT~~ advised that it was his understanding that "the movement", as referred to by FRANCIS GILLINGS in his threats against the President and Vice President, was, in fact, the SAO. Source advised that GILLINGS, to date, has not specifically mentioned that he is a member of the SAO. Source further advised that since GILLINGS had just returned from a meeting with JAMES WALTER SCOTT at Fresno, California, he felt the threats against the President were probably a result of GILLINGS discussion with SCOTT.

Source stated that GILLINGS was also very likely trying to impress source and others at the meeting as to his importance in "the movement"; however, in view of the seriousness of the threat, source would continue attempts to learn if this was, in fact, an actual plot against the President.

On 12/9/72, ~~INFORMANT~~ advised that he had met with ~~INDIVIDUALS NAME~~ a reported leader in the ~~PLACE + ORG.~~ and that ~~NAME~~ showed him a copy of a letter he received from the SAO, which is quoted as follows:

~~DELETED TO PROTECT INFORMANTS~~

SC 175-55

"SECRET ARMY ORGANIZATION  
GENERAL HEADQUARTERS

URGENT

"To all members, supporters, and friends of the SAO. Arrests of many of the members in San Diego have caused some changes of strategy.

"All Post Office Boxes, Drops, Cutouts, and Courier Routes have been discontinued. It is imperative that you do not try to contact the organization in any manner.

"For the next few months our members are being directed to join the John Birch Society under assumed name. The purpose is three fold: The JBS needs the help that our professionals can lend; some of our members need the political training that the JBS can offer; the JBS is a fertile recruiting ground for more militant underground activities.

"You will be contacted at a much later date with further instructions.

"Best wishes and keep your powder dry.

"Lt. Col. Calvin E. Dubbins

"SAC General Staff

"CHD:dgt"

Source advised that according to pamphlets he received from WILSON, the NAKBA has its national headquarters at 909 North Central Avenue, Medford, Oregon.

SC 175-55

Previous informant information received from Phoenix 783-E indicates that DAVID L. WILSON has been in communication with the SAO through JAMES KLEIMAN (SC 157-2493).

LEADS:

All offices contact informants and sources in the SAO and TRC and determine if there is a specific plot to assassinate the President and Vice President.

All offices target informants to determine involvement of members of TRC with white extremist activity.

PORTLAND

AT PORTLAND, OREGON. Will conduct preliminary investigation to determine extent of IWKBA membership involvement in white extremist activity.

SAN DIEGO

AT SAN DIEGO, CALIFORNIA. Insure all offices which have SAO chapters are aware of alleged plot to assassinate President and Vice President.

SACRAMENTO

AT FRESNO, CALIFORNIA. Will continue contact with *SAO is dead* INFORMANT and attempt to establish close coverage of the activities of JAMES WALTER SCOTT.

AT MARYSVILLE, CALIFORNIA. Will review subject's arrest and parole record, Sheriff's Office number A18833, for background information.

AT STOCKTON, CALIFORNIA. Will maintain coverage of subject and associates through INFORMANT

SC 175-55

IN VIEW OF GILLINGS' STATEMENTS, HE SHOULD BE  
CONSIDERED ARMED AND DANGEROUS.

FBI

Date: 11/21/72

Transmit the following in \_\_\_\_\_  
(Type in plaintext or code)

Via AIRTEL AIR MAIL  
(Priority)

TO: ACTING DIRECTOR, FBI (157-21670)  
FROM: SAC, SACRAMENTO (157-1947) (P)  
SUBJECT: TAX REBELLION COMMITTEE  
EM - WHG  
OO: Sacramento

*Indicia search  
negative 1/10/73  
EHB*

Enclosed for the Bureau are eight copies of an LHM reflecting information on captioned subject.

Information contained in the LHM provided to Agent HARRY GREEN, Internal Revenue Service, Stockton, California on 11/9/72.

The individual providing information to source mentioned in LHM is JAMES CARLYLE GLENN, SC 157-2493, 315 South Gro, Stockton, California. GLENN is currently under investigation by the Sacramento Division on information received from INFORMANT on 10/29/72 and 11/3/72 which indicates GLENN has applied for membership in the Secret Army Organization (SAO).

An information copy is being provided to Phoenix in view of their informant coverage.

- 2 - Bureau (Enc. 8)
- 1 - Phoenix (Info)
- 6 - Sacramento
  - (1 - 170-304)
  - (1 - 157- ) (Secret Army Organization)
  - (1 - 157-2493) (JAMES CARLYLE GLENN)
  - (1 - 55-21 )

157-2815-33  
SEARCHED \_\_\_\_\_  
SERIALIZED \_\_\_\_\_  
*Petersen*

TRK/dgr

SC 157-1947  
TRK/dgr

Source is *INFORMANT* and located in instant  
LHM.

LEAD

SACRAMENTO

AT STOCKTON, CALIFORNIA: Will continue contact  
with *INFORMANT* for further details on captioned subject  
as well as information on the operation of the SAO.



UNITED STATES DEPARTMENT OF JUSTICE

FEDERAL BUREAU OF INVESTIGATION

Sacramento, California

November 21, 1972

In Reply, Please Refer to  
File No.

TAX REBELLION COMMITTEE

On November 9, 1972, a confidential source with whom contact has been insufficient to determine reliability advised he learned through an individual who claims to be a member of the Tax Rebellion Committee (TRC) that in the near future members of the committee plan to place seizure notices, like those used by the Internal Revenue Service (IRS), on property and automobiles.

Literature handed out by the National Tax Rebellion Committee indicates its national headquarters are located at Box 666, Clovis, California, and the purpose is to oppose the "unlawful graduated income tax and revolt against paying this tax".

Source stated he received numerous handouts from the above-mentioned individual and a copy of items listed below are attached hereto:

1. Instructions on how to order and place "Seizure" notices.
2. Xerox copy of "Seizure" notices, original of which was blue in color and on a 5½ inch by 8½ inch card.
3. Copy of literature commencing Dear Jim and signed by Myron L. Katzenback.
4. Copy of W-4 form (Withholding Exemption Certificate).

This document contains neither recommendations nor conclusions of the FBI. It is the property of the FBI and is loaned to your agency; it and its contents are not to be distributed outside your agency nor duplicated within your agency.

TAX REBELLION COMMITTEE

5. Copy of literature entitled Tax Rebellion Committee and commencing "October 1972, Dear Patriot" and signed "Constitutionally yours, Tax Rebellion Committee".



Tax fighters: enclosed warning notice is more powerful than a stick of dynamite!!

We propose that thousands of these be placed on property and on automobiles. An avalanche of telephone calls will hit IRS offices.irate, apathetic, silent, easy going tax victims will suddenly be shocked into the real knowledge that the IRS agents who parades as a respectable citizen is in fact a thug, gangster armed with tyrannical power.

We propose that you order 100, 200, 300, or more of these at 5 cents each and place them on automobiles and other property. This placement should be done in such a way as not to be detected by anyone. Four or five fast workers dedicated to the movement can scotch tape 100 on property and automobiles within an hour. Placement should be on windshield or on drivers side of car, cars that are parked for the night when dawn break and sleepy citizens arouse themselves to do daily toil for the tax gatherers. They will discover that their car has been seized.

Pandemonium will break loose.

As mentioned above, order the number of seizure notices you desire at 5 cents each. Order from your tax friends in Fresno. You are aware of the exact name of the group and the address. When ordering please use cash instead of checks. As you well know checks create evidence. You will understand. The enemy is all around us as we take the offensive and move to attack.



# WARNING

## UNITED STATES GOVERNMENT SEIZURE

*This property has been seized for nonpayment of internal revenue taxes,  
by virtue of levy issued by the District Director of Internal Revenue.  
All persons are warned not to remove or tamper with this property, in  
any manner, under severe penalty of the law.*

*Lloyd Fries*  
REVENUE OFFICER

PUBLICATION NO. 34 (REV. 6-66)

U.S. TREASURY DEPARTMENT • INTERNAL REVENUE SERVICE

Sept. 22/72  
2640 Birdseye Cr. Rd.  
Gold Hill, Ore. 97525

Dear Jim,

On Sept 20, 1972 at 10 A.M. at my home, 2 I.R.S. Agent's arrived. They came with 18 witnesses, 6 or more tape recorders and many cameras along with 3 visible loaded weapons. To make matters worse we had a prepared list of questions that we insisted be answered first before they could conduct their interview with me. Needless to say we soon put them down and the Special Agent from Portland (Mr. John Keith) even admitted that he was in quite a dilemma. He only managed to present me with a copy of my inflated W-4 form and ask if I indeed did have and claim 21 dependents. At this time I advised him that I would stand on the 5<sup>th</sup> Amendment of the Constitution.

At 4 p.m. the same day at 909 N. Central St. Efford we again assemble in and for the defence of Mrs. Art Holkanell. Again the same results.

My thanks to you Sir, your help to me on the past Memorial Day weekend at your office along with the literature and personal guidance have this day helped this small band of patriots prevail.

Very truly yours  
Myron S. Ketzelsch

Form **W-4E**  
Department of the Treasury  
Internal Revenue Service

# Withholding Exemption Certificate

(For use by employees who anticipate no tax liability for 1972.)

1972

Type or print full name

Social Security Number

Expiration date (see instructions and enter date)

Home address (Number and Street)

City, State, and ZIP Code

Employee.—File this certificate with your employer. Otherwise he must withhold Federal income tax from your wages.

Employer.—Keep this certificate with your records. This certificate may be used instead of Form W-4 by those employees qualified to claim the exemption.

Employee's certification.—Under penalties of perjury, I certify that I incurred no liability for Federal income tax for 1971 and that I anticipate that I will incur no liability for Federal income tax for 1972, under the Laws of the Land and the U.S. Constitution, Art. I, Sections 8 and 10 (Signature) & Amend's. V, IX & X.

(Date)

Form **W-4E**  
Department of the Treasury  
Internal Revenue Service

# Withholding Exemption Certificate

(For use by employees who anticipate no tax liability for 1972.)

1972

Type or print full name

Social Security Number

Expiration date (see instructions and enter date)

Home address (Number and Street)

City, State, and ZIP Code

Employee.—File this certificate with your employer. Otherwise he must withhold Federal income tax from your wages.

Employer.—Keep this certificate with your records. This certificate may be used instead of Form W-4 by those employees qualified to claim the exemption.

Employee's certification.—Under penalties of perjury, I certify that I incurred no liability for Federal income tax for 1971 and that I anticipate that I will incur no liability for Federal income tax for 1972, under the Laws of the Land and the U.S. Constitution, Art. I, Sections 8 and 10 (Signature) & Amend's. V, IX & X.

(Date)

Suggested instructions: Keep one W-4E form; give one to your employer and send one to the I.R.S. Official Notice To Stop Withholding ... to the I.R.S.

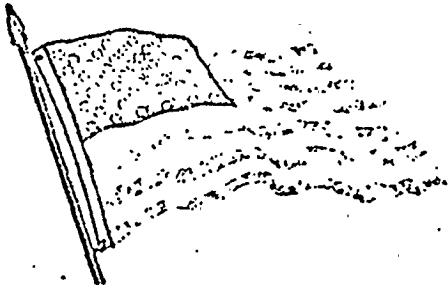

# TAX REBELLION COMMITTEE



Jim Scott  
National Chairman

KILL THE INCOME TAX - THE ROOT OF ALL EVIL

1843 E. BELMONT FRESNO, CA 93701

Either National or International

### ADVISORS:

EDMON KAISER, D.C.  
FREMONT, CA.

DERRELL DAY  
FRESNO, CALIF.

EDWARD DIETZ, DDS  
FRESNO, CALIF.

CLEMENT TAVARES, M.D.  
FRESNO, CALIFORNIA

ANITA KERNS, PUBLISHER  
LOS ANGELES, CALIF.

GORDON L. CRUIKSHANK, ARCH-BISHOP  
ROLLING MEADOWS, ILLINOIS

BILL GARDINER  
OTTER ROCK, ORE.

LAURENCE SMIT  
SOLIKES, MO.

FRANCIS BILLINGS, PROP.  
TRACY, CALIF.

KATHRYN M. DEATS  
ALBUQUERQUE, N.M.

CHURCH E. MURDOCK, JR.  
MOBILE, ALABAMA

JIM FREED  
LANSING, MICH.

OCTOBER 1972

DEAR PATRIOT,

WILL YOU SERIOUSLY CONSIDER INSTALLING A TELEPHONE MESSAGE MACHINE IN YOUR AREA? THIS AMOUNTS TO A MINATURE BROADCASTING STATION WITH A 24 HOUR A DAY TAX REBELLION MESSAGE. SUCH A MACHINE CAN BE PURCHASED FROM A PRIVATE FIRM OR CAN BE RENTED FROM THE TELEPHONE COMPANY FOR A MONTHLY FEE. THE MESSAGE IS APPROXIMATELY 2 MINUTES LONG. PLEASE CALL THE FRESNO NUMBER ON THE ENCLOSED PINK CARD FOR EXAMPLE. IF YOU DESIRE WE COULD FURNISH THE SAME MESSAGE FOR YOUR MACHINE THAT IS NOW ON THE FRESNO MACHINE, WITH YOUR LOCAL ADDRESS ON THE END OF THE MESSAGE. WE WILL FURNISH TO YOU THE CARDS ENCLOSED WITH YOUR LOCAL NUMBER AT THE ROCK BOTTOM COST OF PRINTING. BEST OF ALL AT THE END OF THE MESSAGE WOULD BE YOUR LOCAL ADDRESS AND WHEN YOU RECIEVE ORDERS FOR THE PACKETS AT \$5.00 EACH SEND US \$2.00 AND WE WILL MAIL PROMPTLY TO THE PURCHASER. THIS WILL ALLOW YOU A PROFIT OF \$3.00 PER PACKET TO COVER COST OF THE MACHINE AND THE RELATED EXPENSES. WE MUST USE EVERY AVENUE TO SAVE WHAT IS LEFT OF OUR REPUBLIC. KEITH MCCORMAC INFORMS US THAT 2 MACHINES ARE NOW OPERATING IN BAKERSFIELD WITH 1800 CALLS PER WEEK BEING RECEIVED. LET'S HIT THE ENEMY WITH ALL WE'VE GOT. THE TELEPHONE MESSAGE IS ONE OF THE BEST WAYS TO DO IT.

13

ACTING DIRECTOR, FBI (157-21670)

11/21/72

SAC, SACRAMENTO (157-1947) (P)

JAMES MILLER SCOTT

SI - WNC

OO: SC

Enclosed for the Bureau are seven copies of an LHM regarding subject and one copy each of seizure notice and accompanying letter explaining it.

Enclosed for Los Angeles are two copies of an LHM regarding subject and one copy each of seizure notice and accompanying letter explaining it.

ADMINISTRATIVE:

One extra copy of attached LHM is enclosed to the Bureau for dissemination to IRS.

Confidential source referred to in LHM is **INFORMANT**

On 11/14/72, JIM FLICK, Special Agent, IRS, advised that he received information through a confidential source that unknown subjects were preparing to attach large numbers of Federal Government IRS seizure notices on private property such as automobiles, etc., in an effort to cause citizens to become angered at the IRS.

FLICK provided a copy of the seizure notice and an accompanying letter explaining it. It is assumed that above-captioned subject is responsible for the scheme.

2 - Bureau (Encs. 9)  
2 - Los Angeles (Encs. 4)  
② - Sacramento

JBJ:cca

(6) *a-c-w*

157-2815-33  
SEARCHED \_\_\_\_\_ INDEXED \_\_\_\_\_  
SERIALIZED *4* FILED *MS*

*Peterman* 05

SC 157-1947

AUSA THOMAS COURIS, Fresno, California, advised that the printing, distribution, and attaching of such seizure notices is a possible violation of Title 18, USC, Sections 506, 507, 912, 1017, and 1717.

It is noted that on the letterhead of the Tax Rebellion Committee stationery (of which SCOTT is the national chairman) it lists the Board of advisors for the committee. Among the names listed is ANITA KERN, publisher, Los Angeles, California.

It is also noted that SCOTT puts out, through his Fresno office, a voluminous amount of printed material advocating the nonpayment of taxes.

The possibility exists that this material is being published by ANITA KERN.

LEADS

LOS ANGELES

AT LOS ANGELES, CALIFORNIA

Conduct credit and arrest and indices checks on ANITA KERN and attempt to ascertain if she is the source of printed material for the Tax Rebellion Committee. Particulary, ascertain if she is involved in the printing of copies of Federal Government IRS Seizure Notices.

SACRAMENTO

AT FRESNO, CALIFORNIA

Will, through logical sources, attempt to ascertain if subject is responsible for the distribution and attaching of the seizure notices.

IN VIEW OF SCOTT'S STATEMENTS, HE SHOULD BE CONSIDERED ARMED AND DANGEROUS.

Sacramento, California 95813

November 21, 1972

JAMES WALTER SCOTT

On September 29, 1972, Roger Smith, Intelligence Agent, Internal Revenue Service, U. S. Department of Treasury, Fresno, California, advised that Scott continues to reside at 482 North Poplar, Apartment C, Fresno, California, and that he still maintains his insurance office at 1843 East Belmont, Fresno. Smith advised that on September 25, 1972, Scott was arrested for violation of two counts of Title 26, U. S. Code, Section 7203 (wilful failure to file income tax returns) for the years, 1969 and 1970. Bond was set at \$10,000 and later reduced to \$5,000 corporate surety bond which Scott posted.

Assistant U. S. Attorney, Thomas Couris, Fresno, advised that Scott's trial on above violation was scheduled for April 17, 1973.

On November 3, 1972, a confidential source who is in a position to know advised that Scott is the National Chairman of the Income Tax Rebellion Committee which advocates the nonpayment of taxes as a protest and a means of combat against the Federal Income Tax.

This source further advised that Scott claims to have many unregistered firearms, one of which he keeps in his car and one he keeps in his top right desk drawer. Scott told this source that if anyone came to confiscate his guns or to arrest him, he would shoot them. He further stated that he would not personally hate the officers, but what they represent.

This document contains neither recommendations nor conclusions of the FBI. It is the property of the FBI and is loaned to your agency; it and its contents are not to be distributed outside your agency nor duplicated within your agency.



JAMES WALTER SCOTT

Source further stated that Scott keeps referring to the coming revolution and that "we would have to be so organized that when the revolution comes, all the social science professors and most of the Government bureaucrats could be rounded up and liquidated with as little killing of the populace as possible."

This source further stated that Scott hopes they won't have to kill to save freedom and hopes it can be saved by peaceful means, but is afraid it's too late.

IN VIEW OF SCOTT'S STATEMENTS, HE SHOULD BE CONSIDERED ARMED AND DANGEROUS.

### American Volunteer Groups

Brown wrote to John Zemanek (Huntington Beach, Calif.), Head of the AVG. He asked Zemanek to send him any information that he has on the Secret Army Organization in California. He also asked how the AVG's new front, a foundation, was coming along. He also asked Zemanek's opinion of the N.S.R.P. and its leaders.

### Communist Activities

Donald Walker (Los Angeles, Calif.), a member of the Patric Militia, called Dr. Roy Brown on the evenings of 2nd and 4th of October, 1972 while Dr. Brown was still in Christoval, Texas. He did this to warn Brown that he thought the Cuban Guerrilla Group that he was mixing with was headed by Communists. He stated that he had just mailed a letter but would send another one right away with more details as the first letter had none on the Cubans. He stated that as he had given the Cuban Leader, Juan Araujo, Commanding Officer, Cuban 2505 Brigade, Brown's address and that Brown ought to know it for his own safety.

The first letter from Walker only contained unimportant information and a crazy poem.

The second letter which was written after the phone calls was more lengthly and gave information on the Cuban Group and Walker's reasons for thinking that the leaders are Communists. He also asked for copies of Bill Hanson's (Vero Beach, Florida) book, City Survival-City Resistance as he wanted them for some of his Survival, Anti-Communist converts.

/ni

James "Blackie" Merrell (Houston, Texas), an old timer of the Waterfront section of the Communist Party and a former leader of the Communist Group running the National Maritime Union from its inception in 1937 until 1947, showed up as a Delegate at the Texas State Democratic Party Convention in Houston, Texas that was held in September, 1972. He was still up to his old rattle rousing ways and gave out the old commie line to his fellow Democrat delegates. An interesting note to it is that he flashed a current paid up dues receipt in the Masters, Mates & Pilots Union. This means that he holds a current license as a deck officer issued by the United States Coast Guard. This is strange as ALL Communists were supposed to have had their merchant marine papers taken away from them in the late 1940's. This was as a national security measure to insure that no commies would be on American merchant ships. Merrell evidently still has his in violation of the "Validation for Emergency Service" edict out of Washington.

*Harold H. Hardin*

Date prepared

11/24/72

Date received

11/7/72

Received from (name or symbol number)

INFORMANT

Received by

SA JOHN L. SPURGERS, JR.

Method of delivery (check appropriate blocks)

in person  by telephone  by mail  orally  recording device  written by Informant

If orally furnished and reduced to writing by Agent:

Date

Dictated 11/24/72 to P. EDWARDS

Date of Report

10/31/72

Transcribed N/A

Date(s) of activity

10/2 - 31/72  
14541\*

Authenticated by Informant 10/31/72

Brief description of activity or material

Current activity of NSRP, SAO, AVG and New Minutemen.

File where original is located if not attached

170-61A-48

\* INDIVIDUALS DESIGNATED BY AN ASTERISK (\*) ONLY ATTENDED A MEETING AND DID NOT ACTIVELY PARTICIPATE. VIOLENCE OR REVOLUTIONARY ACTIVITIES WERE NOT DISCUSSED.

Information recorded on a card index by \_\_\_\_\_ on date \_\_\_\_\_

Remarks:

- 2 - Atlanta (Page 1)
- ② - San Diego (Page 1)
- 2 - Baltimore (Page 1)
- 2 - Los Angeles (Page 2)
- 2 - Houston (Page 2)
- 3 - Dallas (1 - 170-61A-48)  
(1 - 157-2213) (BROWN)  
(1 - 157-1592) (MM)

Dissemination to appropriate files being left to the discretion of receiving offices.

*1cc to Special 5  
1 x copy copy to 157-1798  
2 x copy copy to 157-nm (Dublin)*

157-2815-329

SEARCHED  INDEXED   
 SERIALIZED  FILED   
 DEC 3 1972  
 FBI - SAN DIEGO  
 Attach Stamp

Searched.....Indexed....  
 Serialized.....Filed.....  
 DEC 4, 1972  
 FBI - DALLAS

To:  Director, Att.: \_\_\_\_\_  
 SAC,

- Albany
- Albuquerque
- Alexandria
- Anchorage
- Atlanta
- Baltimore
- Birmingham
- Boston
- Buffalo
- Butte
- Charlotte
- Chicago
- Cincinnati
- Cleveland
- Columbia
- Dallas
- Denver
- Detroit
- El Paso
- Honolulu

- Houston
- Indianapolis
- Jackson
- Jacksonville
- Kansas City
- Knoxville
- Las Vegas
- Little Rock
- Los Angeles
- Louisville
- Memphis
- Miami
- Milwaukee
- Minneapolis
- Mobile
- Newark
- New Haven
- New Orleans
- New York City
- Norfolk

- Oklahoma City
- Omaha
- Philadelphia
- Phoenix
- Pittsburgh
- Portland
- Richmond
- Sacramento
- St. Louis
- Salt Lake City
- San Antonio
- San Diego
- San Francisco
- San Juan
- Savannah
- Seattle
- Springfield
- Tampa
- Washington Field

Date 12/8/72

RE:

REMARKS:

157-2815

SEARCHED _____	INDEXED _____
SERIALIZED _____	FILED _____
DEC 11 1972	
FBI - SACRAMENTO	

*Return of*

SAC *John M. ...*

FILE #:

OFFICE Sacramento

Date prepared

12/6/72

Date received

12/4/72

Received from (name or symbol number)

INFORMANT

Received by

SA THOMAS R. KINBERG

Method of delivery (check appropriate blocks)

in person  by telephone  by mail  orally  recording device  written by Informant

If orally furnished and reduced to writing by Agent:

Date

Dictated 12/4/72 to \_\_\_\_\_

Transcribed 12/8/72 by Emily P. Grey

Authenticated by Informant \_\_\_\_\_

Date of Report

12/3/72

Date(s) of activity

12/3/72

Brief description of activity or material

Coverage of Secret Army Organization (SAO), Tax Rebellion Committee, and threat against the President

File where original is located if not attached

170-304A-1

\* INDIVIDUALS DESIGNATED BY AN ASTERISK (\*) ONLY ATTENDED A MEETING AND DID NOT ACTIVELY PARTICIPATE. VIOLENCE OR REVOLUTIONARY ACTIVITIES WERE NOT DISCUSSED.

Information recorded on a card index by \_\_\_\_\_ on date \_\_\_\_\_

Remarks:

Informant furnished information in written statement; however, because of his inexperience, the information was rewritten by SA THOMAS R. KINBERG.

- 1 - Los Angeles (RM)
  - 1- (Tax Rebellion Committee)
- 2 - Phoenix (RM)
  - 1- 170-37
  - 1- 157-1173
- 1 - San Diego (RM)
  - ① 157-2815
- 4 - Sacramento
  - 1- 157-1947
  - 1- 157-2195
  - 1- 157-2493
  - 1- 175-55

TRK:epg  
(8)

157-2915-306

*Petersen*

CAUTION

IF MATERIAL IS DISSEMINATED USE CARE IN PARAPHRASING. Block Stamp

Informant was interviewed on 12/4/72 and could furnish additional information.

Information furnished is confidential and all action taken on this information should be so marked.

All pertinent information should be disseminated to appropriate law enforcement, state or federal agencies.

100-47-1254

SEARCHED _____	INDEXED _____
SERIALIZED _____	FILED _____
DEC 8 1972	
FBI - SACRAMENTO	

Stockton, California  
December 3, 1972

At about 9:30 p.m. on December 3, 1972, a meeting  
of the Tax Rebellion Committee was held at the home of  
Tracy, California.  
Present at the meeting was

*EXCISED BECAUSE INFORMATION  
NOT PERTINENT TO SAA*

EXCISED BECAUSE INFORMATION  
NOT PERTINENT TO SAD

*EXCISED BECAUSE INFORMATION  
NOT PERTINENT TO SAO*

After the meeting, I mentioned that certain Secret Army Organization members had infiltrated certain communist groups and were being assigned target members to be killed off when the time for rebellion was launched.



FBI

Date: 12/4/72

Transmit the following in CODE  
(Type in plaintext or code)

Via TELETYPE NITEL  
(Priority)

TO ACTING DIRECTOR ATTN: D I D  
FROM SACRAMENTO (175-0) (5P)

*175-51X NI*

FRANCIS EARL GILLINGS; EM - THREATS AGAINST THE PRESIDENT.

RESCAIRTEL TO BUREAU ELEVEN TWENTYONE SEVENTYTWO CAPTIONED  
TAX REBELLION COMMITTEE, EM - WHG.

ON TWELVE FOUR INSTANT A CONFIDENTIAL SOURCE WITH WHOM CONTACT  
HAS BEEN INSUFFICIENT TO ESTABLISH RELIABILITY BUT WHO HAS FUR-  
NISHED INFORMATION IN PAST THAT HAS BEEN CORROBORATED BY OTHER  
SOURCES, ADVISED THAT ON EVENING TWELVE THREE SEVENTYTWO THERE  
WAS A MEETING OF TAX REBELLION COMMITTEE AT HOME INDIVIDUAL

ADDRESS

*EXCISED BECAUSE INFORMATION  
NOT PERTINENT TO SAO*

*157-2815-325*

END PAGE ONE  
*SANDIEGO (157-SAC) (AM)*

TRK/LCH

SEARCHED	INDEXED
SERIALIZED	FILED
DEC 7 - 1972	
FBI - SAN DIEGO	

*DeLoe*

FBI

Date:

Transmit the following in \_\_\_\_\_  
(Type in plaintext or code)

Via \_\_\_\_\_  
(Priority)

PAGE TWO

SC 175-3

*EXCISED BECAUSE INFORMATION  
NOT PERTINENT TO SAO*

SOURCE ADVISED THAT AFTER MEETING <sup>INDIVIDUAL</sup> MENTIONED CERTAIN MEMBERS OF SECRET ARMY ORGANIZATION (SAO) HAD INFILTRATED CERTAIN COMMUNIST GROUPS AND WERE BEING ASSIGNED TARGET MEMBERS TO BE KILLED OFF WHEN TIME FOR REBELLION WAS LAUNCHED.  
END PAGE TWO

Approved: \_\_\_\_\_  
Special Agent in Charge

Sent \_\_\_\_\_ M Per \_\_\_\_\_

F B I

Date:

Transmit the following in \_\_\_\_\_  
(Type in plaintext or code)

Via \_\_\_\_\_  
(Priority)

PAGE THREE

SC 175-0

THE SAO IS AN ANTICOMMUNIST, PARAMILITARY ORGANIZATION FORMED IN ONE NINE SEVEN ONE IN SAN DIEGO, CALIF. IT INTENDS TO CONDUCT INTELLIGENCE TYPE OPERATIONS AND TO OFFER TRAINING IN URBAN GUERRILLA WARFARE TO BE USED AGAINST "LEFT WING GROUPS" AND SUSPECTED ENEMIES OF THE UNITED STATES.

*EXCISED BECAUSE INFORMATION  
NOT PERTINENT TO SAO*

Approved: \_\_\_\_\_ Sent \_\_\_\_\_ M Per \_\_\_\_\_  
Special Agent in Charge

\*U.S. Government Printing Office: 1972 - 455-574

FBI

Date:

Transmit the following in \_\_\_\_\_  
(Type in plaintext or code)

Via \_\_\_\_\_  
(Priority)

PAGE FOUR

SC 175-0

*EXCISED BECAUSE INFORMATION  
IS NOT PERTINENT TO SAO*

A THIRD SOURCE WHO HAS PROVIDED RELIABLE INFORMATION IN THE PAST ADVISED ON TEN TWENTYNINE SEVENTYTWO THAT JAMES C. KLEIMAN HAD APPLIED FOR MEMBERSHIP IN SAO.

ADMINISTRATIVE:

FIRST SOURCE IS

*INFORMANT*

SECOND SOURCE IS

*CONFIDENTIAL SOURCE*

THIRD SOURCE IS

*INFORMANT*

ON TWELVE THREE SEVENTYTWO AT THREE THIRTY PM SA LEE SCOTT, SECRET SERVICE ADVISED BY SA THOMAS R. KINBERG, FBI.

SACRAMENTO CONDUCTING INDIVIDUAL INVESTIGATIONS ON INDIVIDUAL

END PAGE FOUR

Approved: \_\_\_\_\_ Sent \_\_\_\_\_ M Per \_\_\_\_\_

Special Agent in Charge

U.S. Government Printing Office: 1972 - 455-574

F B I

Date:

Transmit the following in \_\_\_\_\_  
(Type in plaintext or code)

Via \_\_\_\_\_  
(Priority)

PAGE FIVE

SC 175-0

INDIVIDUALS UNDER APPROPRIATE CAPTION.

AIRMAIL COPIE SENT SAN DIEGO.

E N D

Approved: \_\_\_\_\_ Sent \_\_\_\_\_ M Per \_\_\_\_\_  
Special Agent in Charge

\*U.S. Government Printing Office: 1972 - 455-574

SAC, SAN DIEGO (157-3001)

9/25/72

SUPV. ANTHONY J. MALONEY, JR.

GEORGE MITCHELL HOOVER  
EM - SAO

JERRY LYNN DAVIS  
EM - SAO

The local trials in captioned matters are scheduled as follows:

GEORGE MITCHELL HOOVER	10/25/72
JERRY LYNN DAVIS	11/13/72

As in the YAKOVIC matter, the possibility exists that the defense may demand by subpoena duces tecum the production of all written recordings of information furnished by HOWARD BARRY GODFREY *INFORMANT* to the FBI concerning both these subjects.

If such a demand pursuant to subpoena duces tecum is honored by court, we must be in a position to immediately furnish three copies of such material to the Bureau by airtel on the date such order may be demanded.

Upon receipt, the Bureau will consult with the Department and thereafter return to San Diego the excised portions of such recordings of which the Department may authorize our furnishing the court.

SA HOOPER should therefore cause to be prepared three xerox copies of each authenticated report of GODFREY (exclusive of the FD 306); each memo reflecting oral information furnished by GODFREY that may inadvertently not have been <sup>reduced</sup> produced under an authenticated report and each FD 302 as they relate to HOOVER and DAVIS.

2 - 157-3001  
2 - 157-3017  
① - 157-2315  
AJH:cjt  
(5)

*CCO*  
*Respectfully*  
*Peterson*  
*10/30*

157-2815-291

SEARCHED	INDEXED
SERIALIZED	FILED
SEP 27 1972	
FBI - SAN DIEGO	

*IA*

TO: SAC, PHOENIX  
FROM: SA, CLARENCE L. CRANDALL

Date prepared  
10/31/72

Date received: 10/27/72  
Received from (name or symbol number): **INFORMANT**  
Received by: SA CLARENCE L. CRANDALL

Method of delivery (check appropriate blocks)  
 in person  by telephone  by mail  orally  recording device  written by Informant

If orally furnished and reduced to writing by Agent:  
Date \_\_\_\_\_  
Dictated \_\_\_\_\_ to \_\_\_\_\_  
Transcribed \_\_\_\_\_  
Authenticated by Informant \_\_\_\_\_

Date of Report

Date(s) of activity  
October, 1972

Brief description of activity or material  
Two letters to informant from SAM (Jerry Lynn Davis) indicating that the Secret Army Organization is now defunct. Paraphrased.

File where original is located if not attached  
Orig. copies returned to **INFORMANT**

\* INDIVIDUALS DESIGNATED BY AN ASTERISK (\*) ONLY ATTENDED A MEETING AND DID NOT ACTIVELY PARTICIPATE. VIOLENCE OR REVOLUTIONARY ACTIVITIES WERE NOT DISCUSSED.

Information recorded on a card index by \_\_\_\_\_ on date \_\_\_\_\_

Remarks:

Source advised that some time during the last two weeks in October, 1972, JERRY LYNN DAVIS, leader of the Secret Army Organization in San Diego, advised one of his close confidants in the SAO that he had discontinued the use of two mail drops, namely: Artist Supply, P. O. Box 503, Lemon Grove, California; Survival Supply, P. O. Box 1362, Spring Valley, California. DAVIS lamented that, because of the current court proceedings against certain members of the SAO in the San Diego area, the SAO has become defunct as an organization; that unaffected elements of the SAO may possibly band together, but probably under a different label. DAVIS indicated that a small pocket of SAO members exist in the Los Angeles area, and two members are in the Seattle area. These were not identified by name.

- ② - San Diego (RM)
- 2 - Los Angeles (RM) info.
- 2 - Seattle (RM) info.
- 2 - Phoenix
- 1 cc 157-1173 (SAO)
- 1 cc 170-37-A

(8)  
CLC/

*copy to 100-44297*

Block Stamp

157-2815-276  
SEARCHED \_\_\_\_\_  
SERIALIZED  FILED \_\_\_\_\_  
NOV 13 1972  
FBI - SAN DIEGO  
*[Signature]*

UNITED STATES GOVERNMENT

# Memorandum

TO : SAC (157-2815) (P)

DATE: 11/15/72

FROM : SA EARL M. PETERSEN

SUBJECT: SECRET ARMY ORGANIZATION  
EM

On 11/14/72, HOWARD BARRY GODFREY, **INFORMANT** advised that on about 11/12/72, RICHARD FLEURY had severely beaten his wife GENEVIEVE. She was so severely injured that her cheek bone was pushed up into her eye and her nose was broken in two places. She was taken to the hospital and surgery was necessary, including going into the top of her head to correct nerve damage.

Source stated that Mrs. FLEURY has been fooling around with GEORGE MITCHELL HOOVER and has been visiting him in jail on a weekly basis. HOOVER had requested that she bring him a map of Mexico. Source speculated that Mrs FLEURY and HOOVER might intend to flee to Mexico if he is ever released on bond. Source stated that it is his understanding that the SDCSO intends to arrest FLEURY on charges of felonious assault.

- 1 - 157-3017 (Hoover)
  - 1 - 157-3289 (Genevieve Fleury)
  - 1 - 157-3290 (Richard Fleury)
  - 1 - 170-286A
- EMP:emp  
(5)

157-2815-299

SEARCHED	INDEXED
SERIALIZED <i>MS</i>	FILED <i>116</i>
NOV 16 1972	
FBI - SAN DIEGO	

*Petersen*





TO: SAC, PHOENIX (157-1173)

Date prepared

10/31/72

Date received

10/17/72

Received from (name or symbol number)

INFORMANT

Received by

SA, CLARENCE L. CRANDALL

Method of delivery (check appropriate blocks)

by person  by telephone  by mail  orally  recording device  written by Informant

If orally furnished and reduced to writing by Agent:  
Date

Dictated \_\_\_\_\_ to \_\_\_\_\_

Transcribed \_\_\_\_\_

Authenticated by Informant \_\_\_\_\_

Date of Report

Date(s) of activity

9/6/72

Brief description of activity or material

The original application of one JAMES CARLYLE KLEIMAN, Stockton, California, for membership in the SAO.

File where original is located if not attached  
Original returned to source, INFORMANT

\* INDIVIDUALS DESIGNATED BY AN ASTERISK (\*) ONLY ATTENDED A MEETING AND DID NOT ACTIVELY PARTICIPATE. VIOLENCE OR REVOLUTIONARY ACTIVITIES WERE NOT DISCUSSED.

Information recorded on a card index by \_\_\_\_\_ on date \_\_\_\_\_

Remarks:

Informant advised that on 9/6/72, one JAMES CARLYLE KLEIMAN, 315 S. Oro Ave., Stockton, California, 95205, executed an application for membership in the Secret Army Organization. The application was mailed to the mail drop "Mesa Camping Supplies, P. O. Box 1432, La Mesa, California 92041."

A Xerox copy of the original application is attached hereto.

CLC/

- 2 - San Diego
- 2 - Sacramento
- 2 - Phoenix
- 1 cc 170-37-A
- 1 cc 157-1173 (SAO)

Block Stamp

157-2815-290

SEARCHED	INDEXED
SERIALIZED	FILED
FBI - SAN DIEGO	
Return of	

APPLICATION FOR MEMBERSHIP

NOTICE TO APPLICANT: All information on this form will be kept confidential. All records of members of the Secret Army Organization are stored in a way that they can be swiftly destroyed to keep them from falling into unauthorized hands.

Name James Earl Ray Sex M Age 33

Address 3155 5th Ave Marital Status Single  
(Street)

State GA Wife's Name \_\_\_\_\_

Zip Code \_\_\_\_\_ Telephone 404-2779

Date of Birth 21 (Month) 21 (Day) 57 (Year)

Occupation \_\_\_\_\_ Education \_\_\_\_\_

Special Subjects Studied Public Speaking, Leadership, Religion

Do You Speak or Read Any Foreign Language? None

Veteran No Branch 119th Highest Rank PO

What Service Training Have You Had That You Feel Would Be Beneficial To This Organization? \_\_\_\_\_

Physical Description: Height \_\_\_\_\_ Weight \_\_\_\_\_ Color Eyes \_\_\_\_\_

Color Hair Brown Health: Good  Fair \_\_\_\_\_ Poor \_\_\_\_\_

Any Physical Disabilities or Limitations? None

Any Public Speaking or Organizing Experience? Yes If Yes, Please Explain: \_\_\_\_\_

How Many Hours A Week Could You Devote To Working And Training With the S. A. O. ?

Hours \_\_\_\_\_ Best Time: AM \_\_\_\_\_ PM \_\_\_\_\_ Weekdays \_\_\_\_\_ Weekends \_\_\_\_\_

CERTIFICATION

I am a loyal American Citizen dedicated to the defense and survival of the United States as a Constitutional Republic, free from all socialist and communist policies. Enclosed is my \$5.00 membership fee. I agree to pay \$3.00 each month to the Secret Army Organization as membership dues.

Signature of Applicant James Earl Ray Date 9/1/72

**SUPPORT YOUR  
POLICE  
AND KEEP THEM INDEPENDENT!**

**REGISTER  
NOT IN LINE**

*9/19/72  
1000 1st St  
Wichita, KS 67201*

**Get US out!  
OF THE UNITED NATIONS**

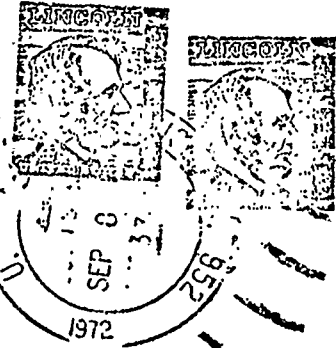

Rob Bible

P.O. Box 172

1017 W. 11th St. S. O.C.C.I.

S. A. C.

P.O. Box 5791

San Diego, Calif. 92105

As you can tell  
the name given is my  
nick-name. I receive  
all mail at my P.O. and  
I am not yet willing to  
give phone number.

Everything else is as is.

I did not sign because  
I don't know that much  
yet to get involved. I am  
one of many who are interested  
and am to be cautious but  
sincere. We all have to be  
slow, but sure at this point.  
Bob

# APPLICATION FOR MEMBERSHIP

NOTICE TO APPLICANT: All information on this form will be kept confidential. All records of members of the Secret Army Organization are stored in a way that they can be swiftly destroyed to keep them from falling into unauthorized hands.

Name: Robby Bible Sex Male Age 33

Address: P.O. Box 171 Jong Beach Marital Status single  
(Street) never married

State: Calif 90801 Wife's Name: \_\_\_\_\_

Zip Code: 90801 Telephone: None

Date of Birth: July 26th 1939  
(Month) (Day) (Year)

Occupation: Warehouseman Education: graduate U.C.L.B.

Special Subjects Studied: mine in math - science - P.E.

Do You Speak or Read Any Foreign Language? No

Veteran: Yes Branch: Army Highest Rank: SP-4

What Service Training Have You Had That You Feel Would Be Beneficial To This Organization? Basic Training U.S. Army, Qualified Tank Commander + gunner.

Physical Description: Height: 5'9" Weight: 150 lbs Color Eyes: GRN.

Color Hair: BRN. Health: Good  Fair \_\_\_\_\_ Poor \_\_\_\_\_

Any Physical Disabilities or Limitations? NONE

Any Public Speaking or Organizing Experience? Yes If Yes, Please Explain: \_\_\_\_\_

I preach the Gospel of our Lord Jesus Christ. we have a Bible study fellowship of which I am the leader-teacher + we are interested

How Many Hours A Week Could You Devote To Working And Training With the S.A.O.?  
in protecting ourselves + our country against communists - atheists

Hours: \_\_\_\_\_ Best Time: AM \_\_\_\_\_ PM \_\_\_\_\_ Weekdays \_\_\_\_\_ Weekends \_\_\_\_\_

I could pray for anything commensurate with my seeing a need, Christian God +

### CERTIFICATION

I am a loyal American citizen dedicated to the defense and survival of the United States as a Constitutional Republic, free from all socialist and communist policies. Enclosed is my \$5.00 membership fee. I agree to pay \$3.00 each month to the Secret Army Organization as members dues

Signature of Applicant: Good Date: \_\_\_\_\_

UNITED STATES GOVERNMENT

## Memorandum

TO : SAC, SAN DIEGO (167-2815) (P)

FROM : SA FRANCISCO L. CASTRO

SUBJECT: INFORMATION CONCERNING  
SECRET ARMY ORGANIZATION  
EXTREMIST MATTERS  
OO: San Diego

DATE: 10/27/72

On 10/26/72, at 10:10 AM, Special Agent John Keefe, United States Secret Service, San Diego, California, advised as follows:

On the morning of 10/26/72, an anonymous caller, described only as a male in his 40's, contacted the McGovern Campaign Headquarters at El Cajon, California and stated that the Secret Army Organization (SAO) had attempted to get him to bomb the McGovern Headquarters in the past. Caller stated that an FBI informant offered him explosives but that he, the caller, had refused to do it. Subsequent to his refusal, his business, a Hertz Rental Franchise, located on the 1900 block of Broadway, El Cajon, California, was blown up, causing him to lose his business.

Unknown caller was referred to the McGovern Headquarters in San Diego where caller spoke to Mrs. Joy Mason, and stated that he was afraid to report this information previously but after listening to McGovern on 10/25/72, he thought it was his duty to make the above information public.

Caller stated that he would contact his attorney for advice and recontact the McGovern Headquarters on 10/27/72, at which time he would possibly reveal his identity.

On 10/26/72, Mrs. Joy Mason, McGovern Headquarters, San Diego, California, was contacted by the writer and advised that she had spoken to unknown caller who furnished the same information given by Secret Service. Mrs. Mason stated that unknown caller had promised to recontact them on 10/27/72, after consulting with his attorney since the above information could not be made public unless caller identified himself.

2-San Diego  
FLC



5010-108

157-2815-287

SEARCHED	INDEXED
SERIALIZED	FILED
OCT 30 1972	
FBI - SAN DIEGO	

*Peterman* | *ef*

Buy U.S. Savings Bonds Regularly on the Payroll Savings Plan

TO: SAC, PHOENIX

Date prepared

10/31/72

Date received

10/27/72

Received from (name or symbol number)

INFORMANT

Received by

SA, CLARENCE L. GRANDALL

Method of delivery (check appropriate blocks)

in person     by telephone     by mail     orally     recording device     written by Informant

If orally furnished and reduced to writing by Agent:

Date

Dictated \_\_\_\_\_ to \_\_\_\_\_

Transcribed \_\_\_\_\_

Authenticated by Informant \_\_\_\_\_

Date of Report

Date(s) of activity

9/12/72

Brief description of activity or material

Letter from DAVID L. WILSON, P. O. Box 2115, Stockton, California 95201, to the SAO.

File where original is located if not attached  
Original returned to source, INFORMANT

\* INDIVIDUALS DESIGNATED BY AN ASTERISK (\*) ONLY ATTENDED A MEETING AND DID NOT ACTIVELY PARTICIPATE. VIOLENCE OR REVOLUTIONARY ACTIVITIES WERE NOT DISCUSSED.

Information recorded on a card index by \_\_\_\_\_ on date \_\_\_\_\_

Remarks:

Informant advised that on 9/12/72, one DAVID L. WILSON, P. O. Box 2115, Stockton, California 95201, sent an unsigned communication to the Secret Army Organization through JERRY LYNN DAVIS, National Coordinator, and made reference to his friend JIM KLIEMAN who had made application to join the SAO.

There is attached hereto a Xerox copy of the original letter referred to above.

CLC/

- ② - San Diego
- 2 - Sacramento
- 2 - Phoenix
- 1 cc 170-37-A
- 1 cc 157-1173 (SAO)

157-2815-288

Block Stamp

SEARCHED *WJ* INDEXED *WJ*

FBI - SAN DIEGO

*W*

Sept. 12, 1972

Dear Sir,

*me* I recently was informed by my friend Jim Klieman, that he sent for and received information on your organization. He tells that you people are interested in the same thing as we are, namely our constitutional right to keep and bear arms. Jim also said he filled out the application form you sent and is awaiting your reply.

I too, would like information on your group. As Jim requested I won't show my return address on the outside of this letter. Thank you for your effort.

Sincerely,

David L. Wilson

P.O. Box 2115

Stockton, Ca. 95201



TO: SAC, PHOENIX (157-1173)

Date prepared

10/30/72

Date received

10/26/72

Received from (name or symbol number)

INFORMANT

Received by

SA, CLARENCE L. CRANDALL

Method of delivery (check appropriate blocks)

in person  by telephone  by mail  orally  recording device  written by Informant

If orally furnished and reduced to writing by Agent:

Date

Dictated \_\_\_\_\_ to \_\_\_\_\_

Transcribed \_\_\_\_\_

Authenticated by Informant \_\_\_\_\_

Date of Report

9/15/72 at Christoval, Texas.

Date(s) of activity

9/15/72 at Christoval, Texas.

Brief description of activity or material

The original letter from Dr. ROY JAMES BROWN, publisher of THE FREE AMERICAN, to the SECRET ARMY ORGANIZATION, San Diego, California.

File where original is located if not attached

170-37-A-144  
157-1173-A

\* INDIVIDUALS DESIGNATED BY AN ASTERISK (\*) ONLY ATTENDED A MEETING AND DID NOT ACTIVELY PARTICIPATE. VIOLENCE OR REVOLUTIONARY ACTIVITIES WERE NOT DISCUSSED.

Information recorded on a card index by \_\_\_\_\_ on date \_\_\_\_\_

Remarks:

There is attached hereto a Xerox copy of a letter dated Sept. 15, 1972, at Christoval, Texas 76935, by one Dr. ROY JAMES BROWN, Publisher of THE FREE AMERICAN, addressed to SECRET ARMY ORGANIZATION, Box 5791, San Diego, California 92105.

Informant advised that he obtained the above letter from JERRY LYNN DAVIS of Lemon Grove, California during the month of October, 1972.

CLC:clq

- 2 - Dallas (RM)
- ① - San Diego (RM)
- 2 - Phoenix
  - 1 cc 157-1173 (SAO)
  - 1 cc 170-37-A

*Block Stamp*

157-2815-286

SEARCHED	INDEXED
SERIALIZED	FILED
NOV - 8 1972	
FBI - SAN DIEGO	

*Harrison*



# The Free American

The Official News Report of The Brown Forum

Dr. Roy James Brown, P.A.E., N.I.A., F.A.S.P.  
Director and Publisher



"Truth Will Prevail Where There Is Pain Taken To Bring It To Light" — George Washington

P.O. BOX 26

CHRISTOVAL, TEXAS 76935

15 SEPTEMBER, 1972

Secret Army Organization  
Box 5791  
San Diego, Calif. 92105

Dear Sirs:

I saw one of your recruiting stickers and am writing to see if you are what I am looking for.

I have been fighting "Communism" in this country since 1947. Several organizations have had my support. I found them and their leaders to be fine dedicated patriots but due to very unfortunate circumstances none have been able to survive as active fighting groups.

I head the Patriot Militia of The Free American Group which has become very inactive for the past three years due to my efforts to amalgamate with larger stronger organizations.

Please send me any information that you might care to. I in return will send you whatever information you desire on me.

In this manner we can look each other over to see if a mutual benefit could be established in the fight to fight for a Free America.

You may know me as I have been very active over the years. I may know you but that remains to be seen when you contact me. I hope that you have "something on the ball" that will be what we need to fight America's enemies from within and otherwise.

I look forward to hearing from you.

For a Free America!

*Roy Brown*

11/1/72

AIRTEL

AIRMAIL - REGISTERED MAIL

TO: ACTING DIRECTOR, FBI (157-26763)

FROM: SAC, SAN DIEGO (157-1820) (P)

WILLIAM FRANCIS YAKOPEC  
EM - SAO  
(OO: San Diego)

Re San Diego teletype to the Bureau dated 10/25/72, and San Diego airtel to the Bureau dated 10/6/72.

Enclosed for the Bureau are five (5) copies of an LHM regarding captioned subject.

A copy of the enclosed LHM has been disseminated locally to the United States Secret Service because the Secret Army Organization (SAO) presents a potential for violence.

Two (2) copies of an FD-376 are attached to the Bureau copies.

San Diego is keeping this case open pending disposition of outstanding charges held against WILLIAM FRANCIS YAKOPEC for violating Sections 12305 and 12303 of the California Health and Safety Code, sections which charge him with Possession of Explosives and Possession Of A Destructive Device.

2-Bureau (Encls-5) (AM-RM)

3-San Diego  
(2-157-1820)  
(1-157-2815)

*JLH:vw*  
(5) *vw*

*W*

*Donnet own* *RD*

157-2815-285

SEARCHED \_\_\_\_\_ INDEXED \_\_\_\_\_  
SERIALIZED *RD* FILED \_\_\_\_\_

SD 157-1820

Subject is not being recommended for ADEX at this time because of his conviction, and sentence of an indeterminate period.

San Diego, California  
November 1, 1972

WILLIAM FRANCIS YAKOPEC

On October 2, 1972, WILLIAM FRANCIS YAKOPEC, an alleged member of the Secret Army Organization (SAO), was found guilty in Superior Court of the County of San Diego on charges of Igniting and Exploding A Destructive Device; Assault With Intent To Commit Murder; Simple Assault; Assault With A Deadly Weapon On A Police Officer; and Possession of Explosives Near A Habitation. The charge of Attempted Murder resulted from the bombing of the Guild Theatre, 3827 Fifth Avenue, San Diego, California, on June 19, 1972.

The Secret Army Organization (SAO) is an anticommunist, paramilitary organization formed in 1971 in San Diego, California. It tends to conduct intelligence-type operations and to offer training in urban guerrilla warfare to be used against "Left-Wing groups" and suspected enemies of the United States.

On October 24, 1972, LARRY WILSON, District Attorney's Office advised that WILLIAM FRANCIS YAKOPEC was sentenced on October 24, 1972, to one year to life and remanded to custody. YAKOPEC has been found guilty of Igniting and Exploding A Destructive Device; Assault With A Deadly Weapon Upon A Police

AJH:vkwy (9)  
*vkwy*

157-2815-285

This document contains neither recommendations nor conclusions of the FBI. It is the property of the FBI and is loaned to your agency; it and its contents are not to be distributed outside your agency nor duplicated within.

WILLIAM FRANCIS YAKOPEC

Officer and Assault To Commit Murder; Simple Assault,  
and Possession of Explosives Near A Habitation.

Before sentencing, WILLIAM FRANCIS YAKOPEC gave an impassioned confession before Judge CONYERS in Superior Court admitting his guilt in the bombing of the Guild Theatre and his having aided the Secret Army Organization.

LARRY WILSON, District Attorney's Office, stated the arrest and conviction of WILLIAM FRANCIS YAKOPEC was directly attributable to the information and testimony of HOWARD BARRY GODFREY.

HOWARD BARRY GODFREY, for a number of years, voluntarily furnished the FBI information regarding the identities and activities of extremist groups in the San Diego area. His information has been reliable and as an interested citizen, he volunteered his knowledge and services to local law enforcement agencies which culminated in his appearance and testimony before the San Diego County Grand Jury in June and July, 1972.

Date prepared

10/20/72

Date received

10/20/72

Received from (name or symbol number)

INFORMANT

Received by

ARTHUR J. COOPER

Method of delivery (check appropriate blocks)

in person  by telephone  by mail  orally  recording device  written by informant

If orally furnished and reduced to writing by Agent:  
Date

Dictated \_\_\_\_\_ to \_\_\_\_\_

Transcribed \_\_\_\_\_

Authenticated by Informant 10/13/72

Date of Report

10/13/72

Date(s) of activity

10/13/72

Brief description of activity or material

INFORMATION VOLUNTARILY PROVIDED NSAPP

PROGAGANDA IN BEHALF OF SAO MEMBERS

File where original is located if not attached

\* INDIVIDUALS DESIGNATED BY AN ASTERISK (\*) ONLY ATTENDED A MEETING AND DID NOT ACTIVELY PARTICIPATE. VIOLENCE OR REVOLUTIONARY ACTIVITIES WERE NOT DISCUSSED.

Information recorded on a card index by \_\_\_\_\_ on date \_\_\_\_\_

Remarks:

1-170-512A-19  
1-157-23 (NSAPP)  
1-157-201 (GERALD LEE SMITH)  
① 157-2815 (SAO)

157-2815-111  
Block Stamp

SEARCHED _____	INDEXED _____
SERIALIZED _____	FILED _____
OCT 20 1972	
FBI - SAN DIEGO	

*Handwritten initials and numbers below stamp*

(The following is an open letter of protest to the SAN DIEGO POLICE DEPT., the EL CAJON POLICE DEPT., the ALCOHOL, TOBACCO, & FIREARMS DIVISION of the U.S. TREASURY DEPT., and the SAN DIEGO COUNTY SHERIFF'S DEPT.)

Dear Sirs:

We, the undersigned, vigorously protest the arrests of William F. Yakopec, George M. Over, Sam Davis, and Mr. & Mrs. Richard J. Fleury—all of whom were arrested in connection with alleged "Secret Army Organization" activity.

Beside from the question of their direct guilt or innocence, there is the matter of the circumstances surrounding their arrests, the importance of which overshadows the question of culpability. We are referring to the gross imbalance of justice exhibited in excessive surveillance, harassment, and penalties for Rightist and White Racialist activists, as contrasted to the almost universal leniency granted the Radical Left.

We hear constantly of riots, Viet Cong flags being raised over U.S. cities and institutions; of lawlessness, murder, violence, conspiracy. In connection with these sordid pieces of news, we typically hear of token arrests (or no arrests), light sentences (if any), dismissals, slaps on the wrist. In short, the Left-wing in this country, as in most countries, flagrantly breaks the law with little or no consequence to themselves.

The salient point is this: the Radical Left consistently breaks the law to advance their ends, and generally gets away with it—constituting a clear and present danger to the internal security of America. It is also apparent that the "authorities" have abdicated from their responsibilities to stop this threat, and have instead stooped to spying on Rightist and Racialist groups and individuals—the overwhelming majority of whom are law-abiding.

In this repressive and threatening atmosphere it is hardly surprising that patriotic Americans are sorely tempted to resort to violent means to preserve their liberties. From this simple observation we can draw the following conclusion: THE ALLEGED INCIDENTS NEED NOT HAVE TAKEN PLACE IF THE LAW-ENFORCEMENT AGENCIES HAD BEEN DOING THEIR JOBS. The fact that the agencies in question did not do their jobs in dealing with the Left meant that for the safety of us all someone else had to do it for them—the best way they knew how. And that "someone else", whoever they may be, should not be held culpable for what ultimately amounts to the "authorities'" dereliction of duty to stop treason, sedition, and subversion.

We consequently demand three things: the dismissal of all charges against the aforementioned "suspects", the end of all surveillance of Rightist and White Racialist groups and individuals, and strict enforcement of the law against ALL Leftist miscreants.

\*\*\*\*\*  
American Patriots! White Racialists! Don't let our FIGHTERS down. They fought for YOU, and now it's up to YOU to help them. When Communists and Radical Leftists are "busted" the entire liberal-Radical community puts itself on the line for them—which is why most go free. We've been letting our activists down, many are still languishing in jails and prisons across the country. Let's let these people know they're not alone. Secure as many signatures for these protest letters as you can, and send them to the agencies involved, or better yet to the newspapers, radio & TV stations. The Reds do the same, and more, for their people. CAN YOU DO ANY LESS?

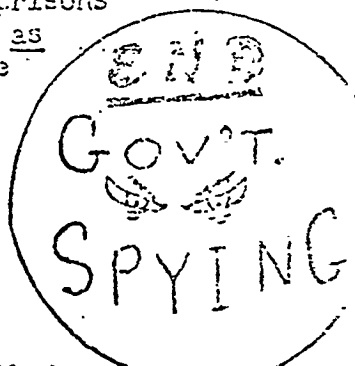



rt by Sandman

October 18, 1972

JECT: NSWPP propaganda in defense of SAO activities.

Enclosed with this report you will find a copy of some literature which demands, among other things, the release of all persons who were arrested in connection with activities of the Secret Army Organization. The author of this literature is Gerald L. Smith of the National Socialist White People's Party. This letter not only defends the actions of the SAO but also condemns most law enforcement agencies for their parts in apprehending SAO members. It also blames the actions of the SAO on the failure of the authorities to stop Leftist lawlessness. The leaflet pretty well speaks for itself so that's all I have to say on that matter.

Date prepared  
10/15/72

Date received  
10/17/72

Received from (name or symbol number)  
**INFORMANT**

Received by  
ARTHUR J. HOOPER

Method of delivery (check appropriate blocks)  
 in person     by telephone     by mail     orally     recording device     written by Informant

If orally furnished and reduced to writing by Agent:  
Date \_\_\_\_\_  
Dictated \_\_\_\_\_ to \_\_\_\_\_  
Transcribed \_\_\_\_\_  
Authenticated by Informant: 10/15/72

Date of Report  
10/15/72

Date(s) of activity  
10/15/72

Brief description of activity or material  
INFORMATION VOLUNTARILY PROVIDED RE: NSWPP  
SAO; GERALD LEE SMITH; GEORGE HOOVER; DENNIS  
LOSO; STANLEY MCDADE; JERRY LYNN DAVIS

File where original is located if not attached

\* INDIVIDUALS DESIGNATED BY AN ASTERISK (\*) ONLY ATTENDED A MEETING AND DID NOT ACTIVELY PARTICIPATE. VIOLENCE OR REVOLUTIONARY ACTIVITIES WERE NOT DISCUSSED.  
 Information recorded on a card index by \_\_\_\_\_ on date \_\_\_\_\_

- Remarks:
- 1-170-512 A-16
  - 1-157-23 (NSWPP)
  - 1-157-200 (GERALD LEE SMITH)
  - ① 1-157-2315 (SECRET ARMY ORGANIZATION)
  - 1-157-3017 (GEORGE HOOVER)
  - 1-157-2933 STANLEY MCDADE (MCDADE)
  - 1-157-3007 (JERRY LYNN DAVIS) 157-3001
  - 1-157-3487 (DENNIS LOSO)
  - 1-157- (WESLEY ROUNDS) (OGA)
  - 1-157- (DEAD) (AL MCDONALD) (MCDONALD)

INDEX TO 157-28 (NSWPP)

~~\_\_\_\_\_~~

~~\_\_\_\_\_~~

*ca*

Block Stamp

157-2815-203

SEARCHED <input checked="" type="checkbox"/>	INDEXED _____
SERIALIZED <input checked="" type="checkbox"/>	FILED _____
OCT 19 1972	
FBI - SAN DIEGO	

*H. J. Hooper*

SUBJECTS: Activities of Dennis Loso--Joint activities of NSWPP & SAO.

Enclosed you will find a newspaper clipping and a photograph which describes the opening of the John Schmitz for President headquarters in Escondido. As described in the clipping, Dennis Loso is the second man from the right. It figured that Loso would be involved in this because he was a great Schmitz supporter long before this presidential race. The other three men I do not know. However, there are some of his hunting and political associates of which I could tell you something. One is Wesley Rounds. This man has been worked on for a long time by Loso. Politically, he has always tended toward the right, but Loso has succeeded in bringing him much farther along toward National Socialism. Rounds is manager of the Californian Motel. It is located in Escondido at the northeast corner of Hwy. 395 and Washington Avenue. Rounds' exact age I do not know but I would guess him to be somewhere in his 40s.--

Sometime back Loso took Rounds to his first William Gale service at Oneira Hall in San Diego. Rounds seemed impressed with Gale. Wes is married.

Another man who periodically visits Loso is Al McDonald. Al is 40 years old and is a friendly, congenial type of person. He is single and spends much of his time in Montana "living the good life." Whenever he runs low on money, he comes down to Escondido and works for Dennis for a while. He claims that he managed to live on just \$3,000 last year. McDonald also spends a fair amount of time living in Montague, California. This town is located in Siskiyou County near the Oregon border. McDonald's parents also live there. They very much disapprove of his Nazi sympathies. On one occasion, his Mother found a large swastika in his cabin while he wasn't there. She threw it in his wood burning stove and would have burned it except that she couldn't find any matches. His most recent visit to Escondido was in July and August at which time he gave the swastika flag to Loso for safe keeping. Loso allowed McDonald to stay rent free in one of his unoccupied apartments.

I learned from Gerald Smith recently that as long as one year ago, there were joint target practice sessions between members of the NSWPP and the SAO. The site of these little excursions was the Gunsmoke Ranch. Gerald says the place is virtually a stronghold of the Minutemen. Participants in the target shooting sessions most frequently were Gerald Smith, Ray Wilson, Mrs. Ray Wilson, Stanley McDade, Jerry Lynn Davis and George M. Hoover. Gerald says Hoover is a crack shot with either a rifle or pistol. Gerald himself qualified as an expert rifle shot in the service.

That's all for now. Take care and see you later. Sincerely,

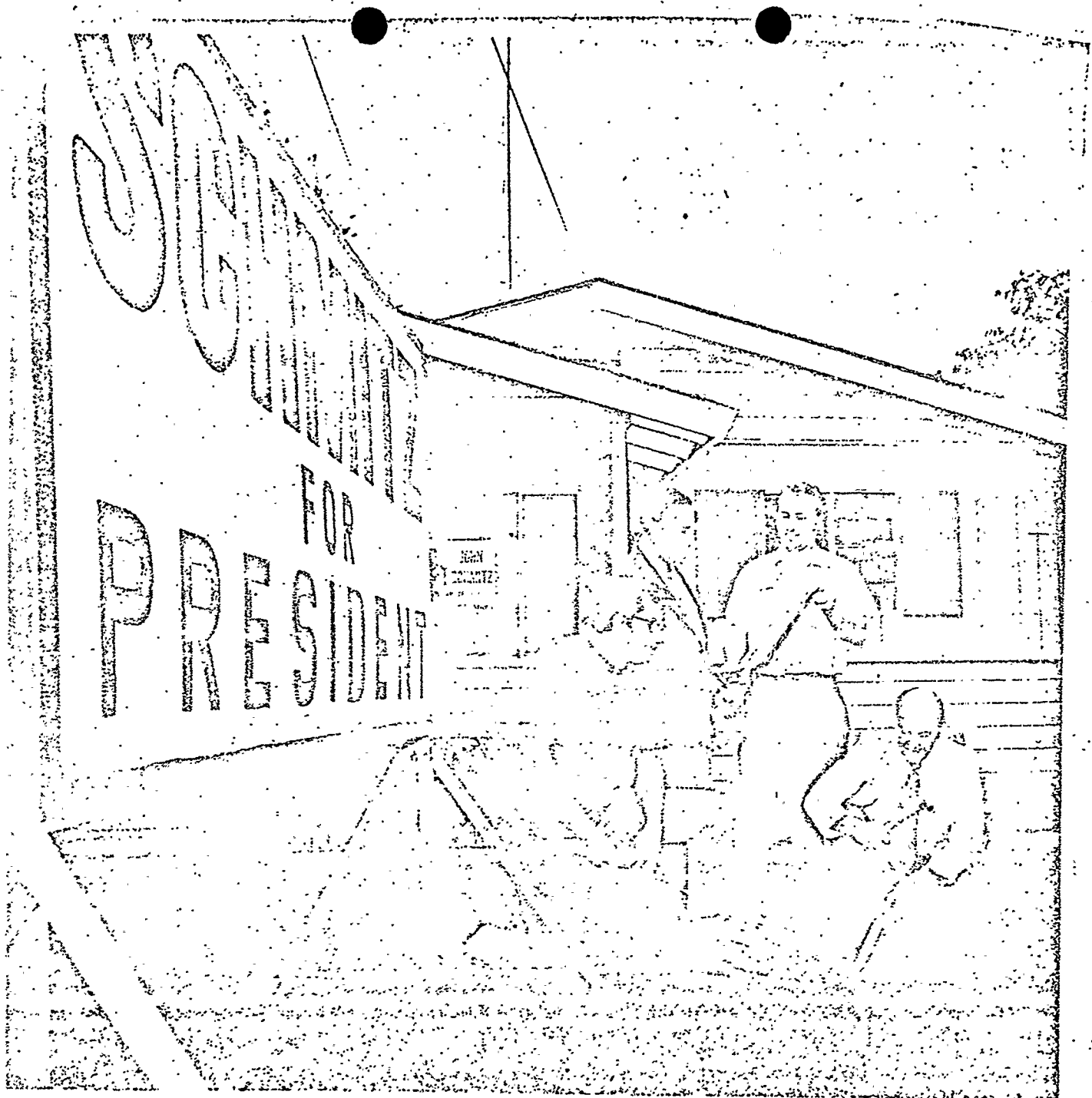

Staff Photo by Dan Rios

10-10-72

T-A, ESCONDIDO

## Office opened by Schmitz backers

Working for the John Schmitz presidential campaign in the Escondido area are (from left) Bob Freeman, Dale Talbot, Dennis Loso and Jack Swigart, as they erect a sign

at local Schmitz headquarters, 137 W. Washington Ave. The office will be open from 10 a.m. to 3 p.m. and 5 p.m. to 8 p.m. Monday through Saturday.



# FBI SUMMARY OF EXTREMIST ACTIVITIES

October 18, 1972

WEEK OF OCTOBER 9 - 15, 1972

## ARMS REPORTED AT NEWTON FACTION PANTHER OFFICE

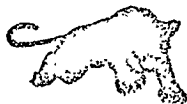

Despite the Black Panther Party Newton Faction current line of *work within the system*, the Winston-Salem, North Carolina, headquarters of this group has rifles and pistols stored there and other weapons are kept in nearby houses. This chapter recently received orders from Panther headquarters in California to defend local headquarters at all costs and the local group was criticized for allowing police to search its office last year. The Winston-Salem Chapter, one of the most active Newton Faction Units, as noted in the October 4 Summary, is also discussing a possible firearms training program. In addition, a member of the group is reported to be planning a surveillance of the local office of the FBI. (C)

## AFRO-AMERICAN LIBERATION ARMY CLAIMS POLICE CAR BOMBING

An unmarked police cruiser was destroyed by a heavy explosive blast October 7 in Los Angeles. Shortly after the bombing a reporter received an anonymous call claiming credit for the bombing for the Afro-American Liberation Army. This is a name used by the military arm of the Cleaver Faction of the Black Panther Party and is the same as the Black Liberation Army. This was the 28th attack on police vehicles and installations; police equipment has been subject to 13 bombings, one attempted bombing, 9 fire bombings, and 5 arsons in the U. S. this year. (U)

## BLACK WORKERS CONGRESS MEETING ATTRACTS MARXISTS

Delegates to the International Black Workers Congress (IBWC) meeting held September 2-3 in Lincoln Heights, Ohio, included Black Panthers, "citizens" of the separatist Republic of *Black*

157-2815-265

SEARCHED	INDEXED
SERIALIZED	FILED
OCT 20 1972	

CLASSIFIED BY ACTING DIRECTOR, FBI  
EXEMPT FROM GENERAL DECLASSIFICATION  
SCHEDULE OF EXECUTIVE ORDER 11652  
EXEMPTION CATEGORY 2  
AUTOMATICALLY DECLASSIFIED ON INDEFINITE

THIS DOCUMENT CONTAINS FEATHERED CLASSIFICATIONS NOR CONCLUSIONS OF THE FBI. IT IS THE PROPERTY OF THE FBI AND IS LOANED TO YOUR AGENCY; IT AND ITS CONTENTS ARE NOT TO BE DISTRIBUTED OUTSIDE YOUR AGENCY NOR DUPLICATED WITHIN YOUR AGENCY.

not pg 2

, members of the Puerto Rican Socialist Party and  
 o Rican Revolutionary Workers Organization (formerly  
 g Lords Party). One speaker was a former member of  
 munist Party, USA, and another, an IBWC leader from  
 ornia, advocated formation of cadres to advance  
 kers' understanding of Marxism-Leninism. The IBWC, which  
 vocates a nationwide work stoppage, did not achieve its  
 goal of 500 to 3,000 persons at this conference (August 23  
 Summary), but did attract 450 delegates from 13 states and  
 the District of Columbia. (U)

#### BOMB FACTORY LOCATED IN CLEVELAND



After the African Peoples Party was evicted from  
 its headquarters for nonpayment of rent, the  
 landlord found bomb-making materials and ammunition  
 in the building. Materials for pipe bombs,  
 practice hand grenades, .45 caliber ammunition,  
 and oxygen breathing apparatus were seized in  
 the office. This group advocates an independent  
 nation for *African captives in America* and demands the  
 territory of 5 southern states. The African Peoples Party  
 branch in Philadelphia claimed long-time revolutionary  
 Max Stanford as its leader. (May 24 Summary) and called  
 its *Black Guard...the most powerful people's liberatio*  
*army.* (C)

#### SECRET ARMY MEMBER CONVICTED, OTHERS CHARGED

A member of the vigilante Secret Army Organization (SAO) was  
 convicted in San Diego October 2 on bombing charges and 2  
 others with SAO connections were indicted for perjury  
 October 10 as a result of the first trial. The bombing was  
 not the first violence attributable to the SAO; the white  
 hate-type group has also been linked to an attack on a  
 "radical" professor. The August 2 summary noted that large  
 amounts of SAO weapons and explosives were seized in July.  
 (U)

#### MUSLIMS BUY SECOND NEWSPAPER

The Nation of Islam (NOI) Muslim group has just purchased a  
 weekly community newspaper published in the Chatham area of  
 Chicago for the past several years. The all-black, separatist  
 group is now printing and publishing *This Is Chatham*, but  
 as yet has not used the newspaper to publicize its teachings.  
 Advertisements of Muslim business enterprises are being  
 carried, however, and NOI members are distributing the newspaper,  
 along with the regular Muslim publication, *Muhammed Speaks.* (U)

UNITED STATES GOVERNMENT

# Memorandum

TO : SAC, SAN DIEGO (157-2815) (P)

DATE: 10/19/72

FROM : SA ARTHUR J. HOOPER

SUBJECT: SECRET ARMY ORGANIZATION  
EM - SAO

On 10/19/72 Special Agent JOHN A. KEEFE, United States Secret Service, San Diego, California, requested information regarding known members of the Secret Army Organization (SAO) in conjunction with the protective responsibilities of the United States Secret Service. In conjunction with Special Agent KEEFE's request for identifying information concerning known Secret Army Organization members, Special Agent ARTHUR J. HOOPER provided all pertinent background information on the following known Secret Army Organization members in the San Diego, California, area.

- ROBERT MAYER, JR.                      JERRY LYNN DAVIS
- THOMAS LEE FORREST                    STANLEY MC DADE
- JAMES EVAN POTO                        GENEVIEVE FLEURY
- PAUL RUPPLINGER                        BETTIE ELLEN CARTER
- HOWARD FRANCIS CLARK
- WILLIAM FRANCIS YAKOPEC
- RICHARD FLEURY
- CALVIN FOX
- GEORGE HOOVER

(2)-157-2815

AJH:vkw  
(2) jfw

157-2815-267

SEARCHED	INDEXED
SERIALIZED	FILED
OCT 19 1972	
FBI - SAN DIEGO	



Date 10/11/72

To:  Director

FILE SD 157-2815  
SD 157-3001

Att.: \_\_\_\_\_

Title \_\_\_\_\_

SAC SAN DIEGO

ASAC \_\_\_\_\_

Supv. \_\_\_\_\_

Agent \_\_\_\_\_

SE \_\_\_\_\_

IC \_\_\_\_\_

CC \_\_\_\_\_

RE: \_\_\_\_\_

Steno \_\_\_\_\_

Clerk \_\_\_\_\_

Rotor #: \_\_\_\_\_

ACTION DESIRED

Acknowledge

Open Case

Assign \_\_\_\_\_ Reassign \_\_\_\_\_

Prepare lead cards

Bring file

Prepare tickler

Call me

Return assignment card

Correct

Return file

Deadline \_\_\_\_\_

Search and return

Deadline passed

See me

Delinquent

Serial # \_\_\_\_\_

Discontinue

Post  Recharge  Return

Expedite

Send to \_\_\_\_\_

File

Submit new charge out

For information

Submit report by \_\_\_\_\_

Handle

Type

Initial & return

Leads need attention

Return with explanation or notation as to action taken.

Enclosed for SD, two ccs FD-306.

(RM) (Enc. 2) SD

SAC PAUL J. MOHR

Office PHOENIX *PJM/PS*

See reverse side



Date prep

10/ 9/ 72

received

Received from (name or symbol number)

Received by

10/9/72

~~XXXXXXXXXX~~ INFORMANT

SA CLARENCE L. CRANDALL

Method of delivery (check appropriate blocks)

in person

by telephone

by mail

orally

recording device

written by Informant

If orally furnished and reduced to writing by Agent:

Date

Date of Report

10/9/72

Dictated \_\_\_\_\_ to \_\_\_\_\_

Transcribed \_\_\_\_\_

Authenticated by Informant \_\_\_\_\_

Date(s) of activity

Brief description of activity or material

~~XXXXXXXXXX~~ INDIVIDUAL

of the SAO visits in

~~XXXXXXXXXX~~ CITY-STATE

File where original is located if not attached

170-37-A

\* INDIVIDUALS DESIGNATED BY AN ASTERISK (\*) ONLY ATTENDED A MEETING AND DID NOT ACTIVELY PARTICIPATE. VIOLENCE OR REVOLUTIONARY ACTIVITIES WERE NOT DISCUSSED.

Information recorded on a card index by \_\_\_\_\_ on date \_\_\_\_\_

Remarks:

STATE Informant <sup>DATE</sup> advised that ~~XXXXXXXXXX~~ <sup>INDIVIDUAL</sup> visited in ~~XXXXXXXXXX~~ <sup>INDIVIDUAL</sup> CITY ~~XXXXXXXXXX~~ on ~~XXXXXXXXXX~~, where he conferred with elements of the SAO relative to the future of the organization. ~~XXXXXXXXXX~~ was of the opinion that the Secret Army Organization is now dead as far as San Diego is concerned, but that a coterie of possibly twenty-five individuals in Los Angeles may carry on under the label of the SAO. ~~XXXXXXXXXX~~ <sup>INDIVIDUAL</sup> was of the opinion that what is left of the SAO, because of court proceedings against the group in San Diego, will retrench in terms of activity. All mail drops of the SAO in San Diego have been discontinued, according to ~~XXXXXXXXXX~~ <sup>INDIVIDUAL</sup>

CAREFUL PARAPHRASING OF THE ABOVE INFORMATION MUST OCCUR, IF UTILIZED IN REPORT FORM, IN ORDER TO PROTECT INFORMANT.

CLC/

- 2 - Phoenix 1 - 170-37-A
- 1 - 157-1173 (SAO)
- ② - San Diego
  - 1 cc 157-2315 ✓
  - 1 cc 157-3001
- 1 - Los Angeles (info)

Block Stamp

157-1173-267

SEARCHED	INDEXED
SERIALIZED	FILED
FBI - SAN DIEGO	

*[Handwritten signature]*



27201001 0010 0110

TO : SAC, SAN DIEGO (7-3224)

DATE: 8/31/72

FROM : SAC, LOS ANGELES (157-6836) (P)

SUBJECT: NATIONAL SOCIALIST AMERICAN  
WORKERS PARTY (NSAWP)  
EM - WHITE HATE GROUP  
OO: LA

Re Phoenix airtel to Bureau, 8/10/72.

Enclosed is one copy of reairtel and one copy of the LHM referred to therein and dated 8/10/72.

As copies of enclosures were not previously furnished to San Diego, copies are enclosed. As noted in the LHM, ~~informant~~ advised on 7/12/72 that according to Scott Winchester, National Commander in July, 1972, he had not talked to Secret Army Organization (SAO) people in over a month.

Above is furnished for your information.

- 2 San Diego (Encl. 2) (RM)
- (1- 157-2815) (SAO)
- 2 Los Angeles
- (1- 157-7318) (SAO)

ANC  
(4)

157-2815-20

*[Handwritten signature]*

SEARCHED	INDEXED
SERIALIZED	FILED
SEP 2 1972	
FBI-SAN DIEGO	
<i>[Initials]</i>	



Buy U.S. Savings Bonds Regularly on the Payroll Savings Plan

# Memorandum

TO : SAC, SAN DIEGO (157-2815)

FROM : SAC, SEATTLE (157-1830) (RUC)

SUBJECT: SECRET ARMY ORGANIZATION  
EXTREMIST MATTERS

DATE: 8/29/72

Re Seattle letter to Bureau, 7/11/72.

The following sources have been contacted, none of whom have been able to furnish any information as to the existence of the above mentioned organization.

<u>Source</u>	<u>Date Contacted</u>	<u>Agent</u>
<div style="border: 1px solid black; padding: 5px; display: inline-block;"> <i>Informants</i>  <i>CONF. SOURCES</i> </div>	6/19/72	SA LOUIS M. HARRIS, JR.
	6/22/72	SA LOUIS M. HARRIS, JR.
	8/4/72	SA SIDNEY E. RUBIN
	8/7/72	SA SIDNEY E. RUBIN
	8/2/72	SA CHARLES R. ST. JOHN

The above sources have been instructed to immediately advise this office upon receipt of any information concerning this organization.

Whereas no pertinent information has been determined concerning the existence of this organization, this case being placed in a RUC status in this division. For the information of San Diego, Seattle continuing investigation on SY ANDERSON to obtain background data as he has been reputed to be leader of this organization in Seattle.

- 2 - San Diego (REG)
- 1 - Seattle
- SER;set
- (3)

157-2815-204

SEARCHED _____	INDEXED _____
SERIALIZED _____	FILED _____
SEP 2 1972 FBI—SAN DIEGO	
<i>Moore HSB</i>	



Buy U.S. Savings Bonds Regularly on the Payroll Savings Plan

File—Serial Charge Out  
FD-5 (Rev. 6-17-70)

GPO : 1970 OF-400-586

File 157-2815 Date \_\_\_\_\_  
Class. Case No. Last Serial

Pending  Closed

Serial No. Description of Serial Date Charged

*Serial # 203*

*Skipped*

Employee \_\_\_\_\_  
**RECHARGE** Date \_\_\_\_\_

To \_\_\_\_\_ From \_\_\_\_\_

Initials of Clerk { \_\_\_\_\_  
\_\_\_\_\_  
\_\_\_\_\_ } Date { \_\_\_\_\_  
\_\_\_\_\_  
\_\_\_\_\_ }

*Do Not Remove* \_\_\_\_\_  
Employee Date Charged

Location \_\_\_\_\_

NR 1 WA CODE

12 3 AM 9-2-72 LMG

MI 9-1-72 LRS

TO SAN DIEGO (157-2815)

FROM ACTING DIRECTOR (157-23577) 2P

SECRET ARMY ORGANIZATION (SAO), EXTREMIST MATTERS.

RESDTL AUGUST TWENTY-NINE LAST.

KEVIN T. MARONEY, DEPUTY ASSISTANT ATTORNEY GENERAL, INTERNAL SECURITY DIVISION, DEPARTMENT OF JUSTICE, ON SEPTEMBER ONE INSTANT ADVISED AUTHORITY GRANTED FOR FORMER SA STEVEN L. CHRISTENSEN TO TESTIFY IN ANSWER TO THE PROSECUTION'S QUESTIONS DURING THE TRIAL OF GEORGE MITCHELL HOOVER, SUPERIOR COURT, SAN DIEGO COUNTY, SAN DIEGO, CALIFORNIA, AS WERE FURNISHED THE BUREAU BY TELECOPIER ON AUGUST TWENTY-NINE LAST. ASSISTANT UNITED STATES ATTORNEY (AUSA) PHILLIP H. FILSINGER, SAN DIEGO, WILL BE ADVISED SEPTEMBER SEVEN NEXT BY MR. MARONEY THAT TESTIMONY OF CHRISTENSEN IS TO BE LIMITED TO ANSWERING ABOVE-MENTIONED QUESTIONS OF WHICH AUSA IS AWARE. A CONFERENCE IS TO BE HELD BY AUSA FILSINGER WITH FORMER SA CHRISTENSEN PRIOR TO HIS APPEARANCE AS A WITNESS TO INSURE HE UNDERSTANDS LIMITATIONS OF HIS TESTIMONY AND THAT IN ACCORDANCE WITH CODE OF

END PAGE ONE

*Druff was furnished telephonically on 9/1 and again on 9/5 to AUSA Filfinger. Filfinger advised that he was not in possession of the game we send answers which the SA had authorized for Christensen. A copy of the SA was personally delivered to the SA by SA [unclear] on 9/5/72*

157-2815-202

SEARCHED	INDEXED
SERIALIZED	FILED
1972	
FBI - SAN DIEGO	
<i>Petersen</i>	

PAGE TWO

FEDERAL REGULATIONS, TITLE EIGHTEEN, SECTION SIXTEEN POINT TWELVE, DATA OBTAINED WHILE IN PERFORMANCE OF DUTIES AS SA CANNOT BE DISCLOSED UNLESS APPROVED BY THE ATTORNEY GENERAL. ADDITIONAL DATA REQUIRED IS TO BE FURNISHED THE DEPARTMENT IN ORDER THAT CONSIDERATION CAN BE GIVEN AS TO WHETHER SUCH IS TO BE DISCLOSED. AUSA IS TO BE PRESENT DURING TESTIMONY BY CHRISTENSEN IN ORDER TO PROTECT GOVERNMENT'S INTEREST.

MR. MARONEY REQUESTED AUSA BE ADVISED BY SAN DIEGO OFFICE OF THE ABOVE AND INDICATED IT WOULD BE DESIRABLE FOR KNOWLEDGEABLE SAS OF SAN DIEGO OFFICE TO BE PRESENT DURING CONFERENCE WITH CHRISTENSEN AND AUSA.

END

HOLD

San Diego, California  
August 30, 1972

Mr. Steven L. Christensen  
Post Office Box Number 2  
Kanosh, Utah

Dear Steve:

In reply to your letter of August 23rd, I can certainly understand your reluctance to testify for the reasons mentioned. However, as you are well aware, there are few willing witnesses in any criminal prosecution and the nature of the subjects involved dictate they be brought to the bar of justice.

I have been advised of your communications with Mr. John A. Hewicker, II, Assistant District Attorney, San Diego County, in this matter, and hope that as a result thereof you will arrive at a mutually agreeable course of action.

I would like to mention that any proposed trial testimony regarding information developed as a result of your official duties as a Special Agent of the FBI must be identified and furnished to the Department of Justice in order that consideration can be given as to whether information is to be disclosed by you. SA Earl M. Petersen will coordinate this matter and will assist you in any way possible.

With hopes that the ends of justice will be served with the minimum of inconvenience to you, and that you and your family are adjusting to your new environment, I am,

Sincerely,



REX I. SHRODER  
Special Agent in Charge

1 - Addressee  
(2) - San Diego (157-2815)  
(1 - 157-3017 HOOVER)  
AJM:ajt  
(3)

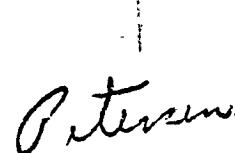
  
157-2815-198

SEARCHED..... INDEXED.....  
SERIALIZED..... FILED.....



San Diego, California  
August 30, 1972

Mr. Steven L. Christensen  
Post Office Box Number 2  
Kanosh, Utah

Dear Steve:

In reply to your letter of August 23rd, I can certainly understand your reluctance to testify for the reasons mentioned. However, as you are well aware, there are few willing witnesses in any criminal prosecution and the nature of the subjects involved dictate they be brought to the bar of justice.

I have been advised of your communications with Mr. John A. Hewicker, II, Assistant District Attorney, San Diego County, in this matter, and hope that as a result thereof you will arrive at a mutually agreeable course of action.

I would like to mention that any proposed trial testimony regarding information developed as a result of your official duties as a Special Agent of the FBI must be identified and furnished to the Department of Justice in order that consideration can be given as to whether information is to be disclosed by you. SA Earl M. Petersen will coordinate this matter and will assist you in any way possible.

With hopes that the ends of justice will be served with the minimum of inconvenience to you, and that you and your family are adjusting to your new environment, I am,

Sincerely,

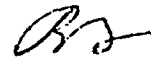

REX I. SHRODER  
Special Agent in Charge

- 1 - Addressee
- 2 - San Diego (157-2815)
- (1 - 157-3017 HOOVER)

AJH:ajt

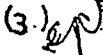
(3) 

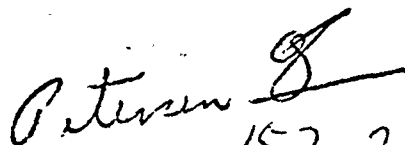

157-2815-197

SEARCHED.....INDEXED.....  
SERIALIZED.....FILED.....

Kanosh, Utah  
August 23, 1972

Rex I. Shroder  
Special Agent in Charge  
Federal Bureau of Investigation  
San Diego, California 92103

Dear Mr. Shroder:

In connection with the investigation and prosecution of the shooting of Paula Tharp, for which Geroge M. Hoover has been indicted, I have received correspondence from Mr. Hewicker of the San Diego County District Attorney's Office asking whether I would be willing to testify in this matter. The purpose of this testimony would be to substantiate the reliability of Howard Godfrey as an informant and to provide information as to the custody of the weapon involved. I have indicated to Mr. Hewicker that I would not be unwilling to furnish such testimony but would be somewhat reluctant due to my present circumstances. It would appear to me that the interests of the Bureau and the District Attorney's Office, as well as myself, would be better served if this information was furnished by someone still connected with the FBI. Godfrey's reliability should be a matter of record to which Earl Petersen could easily testify. Furthermore Mr. Petersen has some first-hand knowlege as to the location of the weapon, and, because of the nature of the incident, I imagine my testimony in this respect would need as much substantiating as Godfrey's.

Another decided disadvantage for me would be the disclosure of my present whereabouts to individuals such as representatives of the "Door", to whom you made reference in your letter of the Fifteenth. I do not desire to be located or contacted by these or similar people. However, if this should occur, I intend to state merely that I left the Bureau on the advice of my personal physician, which would have been an actuality within a period of a few weeks or months anyway.

I would certainly appreciate it if such a course of action as I have mentioned could be made feasible.

Sincerely,

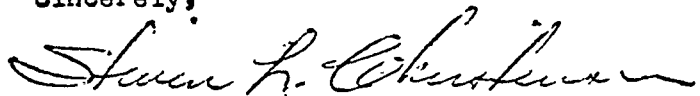

Steven L. Christensen  
P. O. Box #2  
Kanosh, Utah 84637

157-2815-19

SEARCHED	INDEXED
SERIALIZED	FILED
AUG 30 1972	

UNITED STATES GOVERNMENT

# Memorandum

TO : SAC, San Diego (157-2815)

DATE: 8/29/72

FROM : SA EARL M. PETERSEN

SUBJECT: SECRET ARMY ORGANIZATION  
EXTREMIST MATTERS

Attached for the file is a copy of questions to be asked of former SA STEVEN L. CHRISTENSEN at the trial of GEORGE MITCHELL HOOVER on 9/7/72. One copy is being placed in the Hoover file, 157-3017.

The hand written original set of questions received from ~~Assistant~~ Deputy District Attorney John A. Hewicker II, San Diego County has been placed in the 1A file of 157-3017.

A copy of the attached was forwarded to the Bureau by telecopier on 8/29/72.

EMP:emd

(2) *[Handwritten initials]* 1-157-3017

157-2815-191

SEARCHED	INDEXED
SERIALIZED	FILED
AUG 29 1972	
FBI—SAN DIEGO	

*[Handwritten signature]*



Exd-167-167-  
10:15 AM  
8-29-72 jm

On August 28, 1972, JOHN A. HEWICKER, II, Deputy District Attorney, San Diego County, made available to the FBI the following list of questions to be asked of former SA STEVEN L. CHRISTEN on direct examination by the prosecution during the trial of GEORGE MITCHELL HOOVER beginning September 7, 1972:

1. Name?
2. Formerly employed as a Special Agent for the Federal Bureau of Investigation.
3. For how many years?
4. Where was your last duty station?
5. How long were you assigned to the San Diego Office?
6. During the time that you were assigned to the San Diego Office did you become acquainted with an individual known as HOWARD BARRY GODFREY?
7. When approximately did you meet GODFREY?
8. What were the nature of your duties as an FBI Agent at the time you met HOWARD GODFREY?
9. How did you become acquainted with GODFREY?
10. Was there a particular purpose in your becoming acquainted with HOWARD GODFREY?
11. What purpose --?
12. Was there an alternate agent designated as a contact for HOWARD GODFREY?
13. Who?
14. Was GODFREY a paid informant of the FBI?
15. Did the FBI in any way finance the operations of the SAO?
16. How often did GODFREY contact you as an informant?

17. How were these contacts made?
18. During what period of time to your knowledge, did Mr. GODFREY act as an informant for the FBI?
19. What type of information did GODFREY furnish you during the period that he was assigned to you as an informant?
20. Do you recall the reported occurrence of the shooting of PAULA THARP in San Diego in January, 1972, at the home of PETER BOHMER?
21. Did Mr. GODFREY make any contact with you regarding the alleged identity of the person who shot PAULA THARP?
22. When?
23. How was contact made?
24. Did Mr. GODFREY at any time furnish you with a weapon which was allegedly the weapon used in the shooting of PAULA THARP?
25. When?
26. Who present?
27. Where were you when the weapon was presented to you by Mr. GODFREY?
28. What type of weapon was it?
29. What did you do with the weapon at the time it was presented to you by Godfrey?
30. Did you notify any local investigative agency of the information furnished to you by GODFREY, relative to the identity of the person who reportedly shot PAULA THARP?
31. What agency?
32. Who did you confide in at that agency?
33. Did you furnish the San Diego Police Department with the weapon at the time you furnished this information regarding the shooting?
34. Why not?

35. Did you tell anyone at the San Diego Police Department that you had possession of the suspect weapon?

36. How long did you have possession of the suspect weapon?

37. Was the weapon ultimately removed from your possession and turned over to local authorities?

38. Approximately when---

39. Identify if possible this weapon.

UNITED STATES GOVERNMENT

# Memorandum

TO : SAC, San Diego (157-2315)

FROM : SA EARL M. PETEPSEN

SUBJECT: SECRET ARMY ORGANIZATION  
EM

DATE: 8/29/72

Attached for the file is a list of questions and answers for writer's testimony 9/6/72 in the trial of WILLIAM FRANCIS YAKOPEC.

Deputy District Attorney RICHARD HUFFMAN, San Diego County, made available the list of questions.

A copy of the questions is being placed in the YAKOPEC file, 157-1820.

This list of questions and answers were made available to the Bureau by nitel this date for authority for writer to testify.

1 - 157-1820

EMP:emp

(2)

157-2315-19c

SEARCHED	INDEXED
SERIALIZED	FILED
AUG 29 1972	
FBI—SAN DIEGO	

*[Handwritten signature]*



Buy U.S. Savings Bonds Regularly on the Payroll Savings Plan

The following questions will be asked of SA EARL M. PETERSEN on September 6, 1972, by the prosecution as direct testimony in the trial of WILLIAM FRANCIS YAKOPEC:

1. Question: How long have you been assigned as a Special Agent in the San Diego Office of the FBI?

Answer: Since July, 1967.

2. Question: Do you know a person by the name of HOWARD B. GODFREY?

Answer: Yes.

3. Question: How long have you known him?

Answer: About two and one half years.

4. Question: Has he ever performed any services for the FBI?

Answer: Yes.

5. Question: In what capacity?

Answer: He furnished information to the FBI concerning matters of interest to the FBI.

6. Question: For what period of time?

Answer: Since 1967.

7. Question: Was he a paid informant?

Answer: Yes he was.

8. Question: Was he assigned to infiltrate any particular group or groups?

Answer: Yes he was.

9. Question: What particular groups was he assigned to infiltrate?

Answer: The Minutemen and the Secret Army Organization.

10. Question: How long did you work with Mr. GODFREY in his capacity as an informant?

Answer: Mr. Godfrey has contacted me on occasion for about two years.

11. Question: Were you the primary agent responsible for Mr. GODFREY?



Answer: Only since July 10, 1972.

12. Question: Who were the primary agents?

Answer: Special Agent JORDAN NAYLOR and former Special Agent STEVEN CHRISTENSEN.

13. Question: What was your responsibility for Mr. GODFREY?

Answer: I maintained contact with him when CHRISTENSEN was not available.

14. Question: Did Mr. GODFREY report regularly to the FBI concerning the activities of the Secret Army Organization?

Answer: Yes he did.

15. Question: How often did he report?

Answer: On practically a daily basis.

16. Question: Were you present when Mr. GODFREY was first made available as a witness to California Authorities?

Answer: Yes.

17. Question: When did this take place?

Answer: June 26, 1972.

UNITED STATES GOVERNMENT

## Memorandum

TO : SAC, SAN DIEGO (157-2815)

FROM : SA LAWRENCE F. WIRICK

SUBJECT : SECRET ARMY ORGANIZATION (SAO)  
EXTREMIST MATTERS

DATE: 8/23/72

Re San Diego airtel and LHM to Bureau 8/18/72.

Referenced communication has been filed in 157-2815-172. This communication contains information regarding the activities and arrests of the subjects of this case. Due to the volume of the communication, copies were not designated for each individual file but the communication should be consulted when writing subsequent reports or letters.

- ② - 157-2815
- 1 - 157-1820 (WILLIAM FRANCIS YAKOPEC)
- 1 - 157-3017 (GEORGE MITCHELL HOOVER)
- 1 - 157-3290 (RICHARD FLEURY)
- 1 - 157-3289 (GENEVIEVE FLEURY)
- 1 - 157-3001 (JERRY LYNN DAVIS)
- 1 - 157-2931 (ROBERT MAYER, JR.)
- 1 - 157-2546 (HOWARD FRANCIS CLARK)
- 1 - 157-3388 (VAHL BOYLE)
- 1 - 157-2177 (THOMAS LEE FORREST)

LFW:ejt  
(11)

157-2815-175

SEARCHED	INDEXED
SERIALIZED	FILED
AUG 23 1972	
FBI—SAN DIEGO	
<i>W</i>	



5010-104

Buy U.S. Savings Bonds Regularly on the Payroll Savings Plan

3211 Fifth Avenue  
Post Office Box 3636  
San Diego, California 92103  
August 23, 1972

Special Agent In Charge  
18th District  
Office of Special Investigations  
United States Air Force  
4325 Pacific Highway  
San Diego, California 92106

Dear Sir:

This is in reference to your request that information regarding the Secret Army Organization, an anti-Communist paramilitary organization in the San Diego, California, area, be furnished to your office.

An extensive investigation conducted by this office has failed to demonstrate any propensity for violence directed at the Laguna Air Force Station or any other military installation in the San Diego, California, area by the Secret Army Organization. Inasmuch as investigation has failed to disclose any evidence that Office of Special Investigations has an interest in or responsibility for investigating, it is not felt, at this time, that further dissemination regarding this matter would benefit or be of use to your office.

Please be assured that the Federal Bureau of Investigation will continue its investigative efforts in this matter, and will promptly advise and keep your office current of any developments on part of the Secret Army Organization that have a bearing on or relate to your investigative interests.

1-Addressee  
1-San Diego (157-2815)

AJH:vw (2)  
*MW*

Very truly yours,

*RS*  
REX I. SHRODER  
Special Agent In Charge

157-2815-174  
SEARCHED.....INDEXED.....  
SERIALIZED.....FILED.....

TO: SAC, PHOENIX (7-1173)

Date prepared

8/14/72

Date received  
8/14/72

Received from (name or symbol number)

Received by

SA Clarence L. Crandall

Method of delivery (check appropriate blocks)

in person  by telephone  by mail  orally  recording device  written by Informant

If orally furnished and reduced to writing by Agent:

Date

Date of Report

8/14/72

Dictated \_\_\_\_\_ to \_\_\_\_\_

Date(s) of activity

8/6/72

Transcribed \_\_\_\_\_

Authenticated by Informant \_\_\_\_\_

Brief description of activity or material

Re arrest of SAO members in the San

Diego area 6/26/72.

File where original is located if not attached

.170-37-A

\* INDIVIDUALS DESIGNATED BY AN ASTERISK (\*) ONLY ATTENDED A MEETING AND DID NOT ACTIVELY PARTICIPATE. VIOLENCE OR REVOLUTIONARY ACTIVITIES WERE NOT DISCUSSED.

Information recorded on a card index by \_\_\_\_\_ on date \_\_\_\_\_

Remarks:

Source advised that he has learned indirectly that JERRY LYNN DAVIS, who has been in jail in California since July 5, 1972, was released from jail during the first week in August, 1972, and is now living % PAULA HELTON, 3618 Nereis, La Mesa, California, telephone 714-466-5074. Source advised that DAVIS is the leader of the group known in the San Diego area as the SECRET ARMY ORGANIZATION, and that he and three other members of the group were arrested by the San Diego Police Department on or about June 26, 1972. The charges against them were based on the possession of explosives and illegal weapons.

Source advised that the above-mentioned arrest was also based on a shooting wherein the gun of one HOWARD GODFREY was used. The latter is also a member of the SAO and an alleged "double-agent" type informant for the F.B.I. Source stated that it is the intention of the SAO to embarrass the F.B.I. in some unexplained manner when the above-mentioned SAO subjects come to trial.

Block Stamp

- 3 - Phoenix
  - 1 cc 157-1173 (SAO)
  - 1 cc 170-37-A
  - 1 cc 157-620 (NRI)

*1 cc to 170-286A  
1 cc to 157-3001 (Davis)*

157-2815-170

SEARCHED	INDEXED
SERIALIZED	FILED
AUG 16 1972	
FBI - San Diego	
<i>H. C. ...</i>	

- ③ - San Diego (157-2815)

*W. C. ...*

UNITED STATES GOVERNMENT

# Memorandum

TO : SAC (157-2815)

DATE: 8/8/72

FROM : Danny Morris

SUBJECT: SECRET ARMY ORGANIZATION

This date SA ROY REYSA, OSI, San Diego, requested information concerning the Secret Army Organization stating that the Laguna Air Force Base had requested this information.

He was advised that their office would be furnished current data on the SAO as soon as current report is completed.

Furnish OSI with latest report and or copy of LHM when it is available.

1 - San Diego

DM:dm  
(1)

157-2815-165

SEARCHED _____	INDEXED _____
SERIALIZED _____	FILED _____
AUG - 8 1972	
FBI - SAN DIEGO	
<i>[Handwritten Signature]</i> HES	



Buy U.S. Savings Bonds Regularly on the Payroll Savings Plan

UNITED STATES GOVERNMENT

## Memorandum

SAC, SAN DIEGO (157-1820)(P)

DATE: 7/29/72

SA JOE A. WEATHERALL, JR.

SUBJECT: WILLIAM FRANCIS YACOPEC  
EM-SAO  
OO: SDOn 7/20/72, ~~A~~ CONFIDENTIAL SOURCE THROUGHOUT

PAGE

provided information to SA JOE A. WEATHERALL, JR., regarding a 7/17/72, conversation by YACOPEC and YACOPEC. YACOPEC told that he is on the periphery of the SAO and was not allowed to join the group. YACOPEC has heard from "members" of the SAO which he did not mean that they (the SAO members) are planning to kill one or two dozen "long hairs" in San Diego in September or October. YACOPEC stated that he cannot tell authorities of this matter as his wife will be killed within 24 hours.

YACOPEC told source that the Police Department haven't arrested anyone who is significant in the organization.

made further comments not related to his conversation with YACOPEC. He stated that he believed VIC WALTON, Attorney, to be an associate of the SAO. Most of YACOPEC's associates are armed with handguns at all times. commented that HOWARD GODFREY had testified before the Grand Jury, without consulting his attorney and considered this unusual.

stated he provided this information in order to possibly prevent innocent persons from being harmed.

2 - 157-1820 (YACOPEC)

1 - 157-2315 (SECRET ARMY ORGANIZATION)

JAW:mjz

(3) MB

157-2315-145

SEARCHED	INDEXED
SERIALIZED	FILED
JUL 31 1972	
FBI—SAN DIEGO	

M. J. W. J. W.

SD 157-1820

SA EARL M. PETERSEN was advised 7/20/72.

The above information regarding a possible SAO plan was carefully paraphrased to protect the source of dissemination to the following agencies by SA JOE A. WEATHERALL, JR.:

<u>Date</u>	<u>Person Contacted</u>
7/20/72	REUBEN BRANDON Detective, SDPD
7/20/72	NANCY BYRD Deputy Sheriff Intelligence SDSO
7/21/72	JIM BERRIAN Special Agent CBI

Date prepared  
7/6/72

Date received  
7-5-72

Received from (name or symbol number)  
INFORMANT

Received by  
SA CLARENCE L. GRANDALL

Method of delivery (check appropriate blocks)  
 in person     by telephone     by mail     orally     recording device     written by Informant

If orally furnished and reduced to writing by Agent:  
Date \_\_\_\_\_  
Dictated \_\_\_\_\_ to \_\_\_\_\_  
Transcribed \_\_\_\_\_  
Authenticated by Informant \_\_\_\_\_

Date of Report

Date(s) of activity  
JUNE 1972

Brief description of activity or material  
Undated communications from SAM, aka JERRY DAVIS at San Diego, Calif. re SAO.

File where original is located if not attached  
Originals returned to source

\* INDIVIDUALS DESIGNATED BY AN ASTERISK (\*) ONLY ATTENDED A MEETING AND DID NOT ACTIVELY PARTICIPATE. VIOLENCE OR REVOLUTIONARY ACTIVITIES WERE NOT DISCUSSED.  
 Information recorded on a card index by \_\_\_\_\_ on date \_\_\_\_\_

Remarks:  
  
Informant furnished the printed material which is attached hereto in Xerox form.  
  
ANY UTILIZATION OF THIS INFORMATION IN FORM SUITABLE FOR DISSEMINATION MUST BE PARAPHRASED ADEQUATELY to PROTECT THE INFORMANT.  
  
2 - Phoenix  
    (lcc 170-37-A)  
    (lcc 157-1173) SAO  
  
② - San Diego  
    (lcc 157-2815) SAO ✓  
    (lcc 157-3001) DAVIS

157-2815-131

Block Stamp

SEARCHED \_\_\_\_\_ INDEXED \_\_\_\_\_  
SERIALIZED \_\_\_\_\_ FILED \_\_\_\_\_  
FBI - PHOENIX  
*[Signature]*



Identifies

INFORMANT

1 page

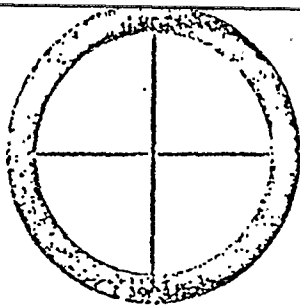

# SECRET ARMY ORGANIZATION

## UNDERGROUND BULLETIN

---

GENERAL HEADQUARTERS

JUNE 1972

---

" The people never give up their liberties but under some delusion ". Edmund Burke

Fellow members,

At a recent meeting of the SAO General Staff a very important problem was discussed and the decision to issue a new Organizational Directive made. The problem is that of new members who join our organization and then immediately become totally inactive.

Typically these new members submit a well qualified application form together with their membership fee. Unfortunately, after being accepted as provisional members they never pay a month's dues or send in any report forms. It would really help us to know why some of these people have acted in this way. Did our organization turn out to be something different than they expected? Did they expect a fancy uniform and rifle to be handed to them on a silver platter? Or did they suddenly become afraid to stick their neck out?

Whatever the reasons, it isn't fair to our good members to waste time and money on those who do nothing to help or support the organization. Therefore, effective immediately, the following rules shall apply to such cases as mentioned above.

1. If, three months after submitting an application to the SAO and being accepted as a provisional member, the new member has not begun the basic correspondence training; submitted monthly report forms, paid monthly dues, or provided a reasonable excuse for not having done the above, their file shall be turned over to our Intelligence Section for special attention.

2. If, after six months, the member in question doesn't respond they shall be dropped from our rolls and their names shall be circulated to all members as a potential security risk.

We don't mean to imply that a member can't resign from the Secret Army Organization. However, we do require that a member notify us of their intent and reasons for doing so. If this new Organizational Directive applies to any member in particular let him take action and govern himself accordingly. GENERAL STAFF - SECRET ARMY ORGANIZATION

## HOW TO PREPARE GUNS FOR STORAGE & BURYING

Although cosmoline can be purchased in many surplus stores, it may be more practical to make your own from the following directions. One advantage to making your own preparation is that it is much easier to apply while it is in a warm state.

Heat non-bleached petrolsum jelly (ember-vaseline) in a small-pan or can. Add 30 or 40 weight motor oil to obtain the proper consistency. Using an inexpensive throw-away paint brush as an applicator, brush the warm solution over the weapon. While the solution is still warm it can also be poured into those hard-to-get-at-areas.

One large jar of petroleum jelly and approximately one-half quart of motor oil is sufficient to prepare several weapons.

When the solution has cooled it will set and form a protective coating over the weapon which should then be wrapped in sheet plastic (available in most hardware or paint stores) or in a G. I. plastic gun case (available in most surplus stores). Wrap well and seal with black electrical or plastic tape. It is also wise to enclose a small sack of silicagel crystals to keep the moisture out. These crystals can be purchased at any industrial chemical house or most appliance stores will give them away as they come with cartons of appliances when shipped and they usually have an abundance on supply.

Long guns which cannot be easily torn down can be stored in surplus rocket type boxes readily available in most surplus stores. Try to obtain aluminum or stainless steel containers since they will not tend to rust when buried. 20mm ammunition cans are adequate and a convenient size container for burying smaller weapons and other items. They should be well sealed. The cans should be wrapped in plastic to prevent rust.

Buried containers should have at least one and a half feet of earth over them. One should be careful also in selecting an area to bury material. Areas that could be flooded during even the most unusual weather conditions should be avoided.

Buried containers should be in such a position that they can be found easily and quickly without the use of maps. This can be done by correlation between two or more specific points that will remain in tact, such as trees, large rocks, etc. To assist your memory, paces should be marked off by using the day, month, and year of your birth or that of some family member which you can easily remember.

Another suggestion would be for burying containers along or near roadways which are marked with numbered signs indicating the footage of road per county. These signs are permanent, but it must be remembered that the state has a 500 foot right away on most roads which means the brush may be cleared or the existing road might be widened.

All material which is buried should be checked within three to six weeks for settling or sinking of the ground.

## GENERAL RULES OF GUERRILLA WARFARE

1. The first rule of guerrilla warfare is to dispense with any rule or set of rules which results in routine or predictable activity. Any time the enemy commander can anticipate what the guerrilla band will do next, he can then lay a trap by which his superiority of numbers and equipment may be brought to bear upon them with devastating effect.

2. Military action by guerrilla bands cannot achieve maximum effect unless intelligence and security capabilities are developed to an equal degree of perfection, principally through the cooperation of friendly non-combatants.

3. Propaganda warfare is one of the guerrillas most effective weapons. It must be waged continuously to demoralize the enemy, enlist support of the civilian population and to justify the existence and actions of the guerrilla bands.

4. Each member of the underground movement must be rendered immune to the enemy's propaganda by continuous counter-propaganda. They must realize that the enemy is certain to spread lies about their leaders, to try and break the bands up by encouraging petty jealousies and dissensions, to make them feel their fight is hopeless, to encourage them to get on the winning side, to offer mercy and rewards to those who voluntarily surrender. Most of all enemy propaganda will be aimed as destroying the individual organization member's faith in the honesty, capability and true motives of other members of the underground movement.

5. Surprise is the main element of successful guerrilla warfare. No matter how vigilant the enemy may be there will be times your band can take him by surprise. Perhaps he is tired, perhaps sleeping, perhaps he is in an area where he feels so completely safe that he lets down his guard-- that's when you hit him.

6. Any guerrilla that wants to keep on living must constantly remind himself that war is not a sporting proposition-- never give the communists an even break.

7. Generally speaking guerrillas must work in small bands. From five to fifteen is usual but even here its best not to get into a rut. If the enemy commander in your area knows you always work in small groups he can then divide his available anti-guerrilla forces into groups of 15 to 25 and thus cover more ground than if he had to maintain groups of two or three hundred to make certain his forces would always out number any guerrilla band they happened upon.

8. The guerrilla leader must always keep his thinking one step ahead of the enemys. Here are some examples:

A staff car filled with enemy officers is travelling along the highway when the driver sees something ahead. As they draw closer they see it is a man, apparently dead, sprawled in the middle of the highway. The car stops and the enemy officers get out to investigate. Suddenly the "corpse" rolls over and cuts them down with a machine gun.

This little trick might work several times but eventually the enemy will figure it out. The driver of a truck full of enemy troops sees a "corpse" lying in the road. Quickly he stops the truck. The troops pile out of the truck and riddle the "corpse" with bullets. Too late they discover its only a dummy made of old clothes and straw. They are caught in a murderous cross-fire between guerrillas hidden along both sides of the road. Most are killed but one lives long enough to tell what happened.

A few days later another truck of troops sees a "corpse" lying in the middle of the highway. The driver has been forewarned so he knows better than to stop. Instead he steps on the gas, runs over the dummy as he speeds on around the next curve in the road-- perhaps into a hidden land-mine. Or perhaps into a chain stretched between two trees. Or perhaps onto a part of the highway that has been covered with fresh oil which sends the truck skidding over an embankment.

What will the next truck full of troops do? What can you figure out so you will still be thinking one step ahead of the enemy?

9. Generally speaking the guerrilla band must avoid superior forces. When attacked by a superior force the guerrillas must quickly retreat or disperse. When the enemy stops, they may return to harass him-- or perhaps they won't. When the enemy is exhausted they may attack-- but again they may not. When the enemy retreats the guerrillas may give chase-- but only if they can be very sure they are not being led into a trap.

10. Guerrillas must always fight at a time and place of their own choosing-- never at a time or place of the enemy's choosing.

11. Before any raid on enemy troops or installations the guerrilla leader must obtain complete and accurate intelligence on the number of the enemy on hand, the number near enough to be called on for assistance, amount and type of enemy armament, location of sentries, scouts or protective patrols and all other information that will effect the planning or conduct of the raid.

12. All raids against the enemy must be exactly planned and carefully rehearsed. It is often desirable to draw a miniature copy of the enemy installation so that all members of the raiding party can play out their respective duties several times to make sure they do not forget or become confused in the heat of battle.

13. Everything that could possibly go wrong must be anticipated and alternate plans made to cope with any eventuality.

14. Guerrillas should strike a violent lightning blow that leaves the enemy stunned at least long enough for them to make a safe retreat.

15. In no case must the guerrillas allow themselves to be drawn into a long pitched battle with enemy troops.

16. So long as friendly forces of the conventional military are able to retain their offensive potential it is expedient for guerrilla forces to coordinate their activities with such friendly troops.

17. Guerrilla bands must always move in secret-- their whereabouts must always be hidden from the civilian population as well as from enemy troops.

18. When possible always attack the enemy at places which are distant from centers of population as this will reduce the possibility of his making reprisals against friendly civilians.

19. If a lone enemy soldier is way-laid in the city or suburbs it is best to carry his body away where it can be buried and the grave camouflaged so his commander will not know whether he has been killed or has deserted. Take his uniform and hide it carefully where it can be later retrieved. It might come in handy.

20. The guerrillas must always operate in their home territory where they have intimate knowledge of their surroundings. If driven from their own territory by a superior enemy force they should return as soon as they safely can, provided that their main hide-out has not been discovered and there is no chance of an enemy ambush.

21. Guerrillas must make every effort to stay friendly with any civilian population in their territory as the civilians may be their best source of food, other supplies, or valuable information about nearby enemy forces.

22. It is almost essential that the guerrilla band have at least one secure hide-out where they can rest up, store their supplies and care for their wounded. This hide-out may be in some large forest or mountainous area but such is not always necessary. During World War II one Russian guerrilla band had their headquarters in a storm sewer. Another band headquartered in the basement of a hospital in one of the smaller towns. Another operated from an abandoned coal mine.

23. The guerrilla band should have one or more alternate hide-outs and be ready to move quickly and quietly to another prepared location in case their main headquarters is discovered. To preserve maximum security the location of these alternate hide-outs should be known to the least possible number of their own band.

24. To operate successfully over long periods of time the guerrilla band must have plenty of space in which to maneuver-- preferably a large enough area that the enemy is incapable of covering all of it with anti-guerrilla forces at one time.

25. Guer. activity is most suitably conducted in mountains, swamp and other types of terrain that are inaccessible to tanks, large guns and mechanized forces but with proper strategy at least some guerrilla activity can be suited to almost any type area-- even large cities. Furthermore, due to the widespread use of light weight weapons such as the bazooka and recoilless rifle it must be expected that mountains will provide somewhat less protection to guerrillas in future wars than they have in the past. Therefore it is essential that underground activity be directed against the enemy under every possible condition and over the widest possible area so as to prevent his concentrating his forces for a complete "mop-up" operation in any one district.

26. Guerrilla forces cannot ordinarily afford to take prisoners. If you are lucky enough to capture a high-ranking officer or party official he may be held for ransom or as a hostage to guarantee against extreme brutality by the enemy or reprisals by the enemy against the civilian population. With extreme caution he may be traded for guerrillas held prisoner by the enemy.

Most commonly any captured enemy must be shot. If prisoners are taken they must be kept in chains and closely guarded day and night. If one were to escape he would certainly lead the enemy back to your hideout.

27. Due to their superior forces, the enemy may make several mistakes and still fight effectively. For the guerrilla band a single mistake may lead to complete annihilation. Therefore every activity must be conducted with extreme caution and complete secrecy.

28. Guerrillas must be extremely tidy housekeepers. Garbage thrown out around camp may attract birds which in turn may alert the enemy. A tin can, carelessly tossed aside may catch the sun just right to be seen by a scouting airplane. While on the march a broken branch or a thoughtlessly dropped match cover may give your presence away to the enemy who could radio ahead to set up an ambush.

29. Each member of the band must be constantly alert that his own action does not give away the guerrilla position to the enemy. In remote areas the smell of smoke may carry for many miles. Even cigarette smoke can give away the sentries position to a quietly approaching enemy scout. On a dark night the glow of a cigarette can be seen for 300 yards. With a good pair of binoculars it can be seen for a mile.

30. A single careless or obstinate member must not be allowed to endanger the lives of the other members of the band.

31. Guerrilla forces cannot afford defeat and are poorly equipped to care for casualties. Therefore, action against the enemy must be taken only under such conditions as insure maximum opportunity for success.

32. Before any action is taken against the enemy one or more clear paths of retreat must be assured.

33. If a guerrilla is killed in action other members of the band should try to take his body with them as they retreat. It will become very demoralizing to the enemy if he is constantly aware of his own casualties but sees no evidence of guerrilla losses.

34. If a member of the guerrilla band is wounded then the other members must carry him away at all costs-- even at the risk of their own lives. This is essential both for the morale of the band but to make certain the fallen guerrilla is not tortured into revealing the identity of his friends and the location of their camp.

35. Guerrilla forces seldom attempt to occupy territory in the usual sense. Instead they seek to dominate the territory by continuous raids, ambushes and harassment of enemy troops to such an extent that continued occupation by enemy forces is no longer worth the price they must pay.

36. Success in guerrilla warfare depends largely on superior mobility.

Transport and movement are therefore of great importance to the guerrilla band. So long as the civilian population is allowed to use their automobiles the guerrillas can (with forged identity cards) do likewise. If the civilian population is rigidly controlled or largely enslaved then the guerrillas must depend on other methods of transportation.

Bands that must move on foot are limited in the distance over which they can operate. Possible targets for sabotage must be within two or three nights march. Even then the guerrillas are apt to be badly fatigued before they go into action and they will have trouble getting away without being discovered.

Suppose that a guerrilla scout reports that a poorly guarded supply column is camped 30 miles away. The guerrilla band may need these supplies desperately but if they must travel by foot the enemy will likely have moved on before they can get there. These are serious problems for which each band must find solutions depending on their own conditions and territory.

37. Close cooperation between different bands is seldom required and may be undesirable. Therefore it is more important that communication between bands be secure than that it be fast.

38. Each guerrilla band is responsible for its own actions and bears the pain of its own mistakes without drawing other bands into any calamity that may befall it.

39. When anti-guerrilla activity becomes very intense, large bands should disperse into a number of small bands that can hide easier, move faster and can filter through enemy lines with less risk of detection.



40. There is a big difference between sabotage and wanton destruction. All guerrilla activities must be conducted so as to cause minimal damage to private property.

41. Hit-or-miss sabotage is not nearly as effective as coordinated sabotage that strikes systematically at some few essential industries of activities vital to the enemy at that particular time.

42. Targets for raids and sabotage must be carefully selected to achieve maximum damage to the enemy with least risk to the guerrilla band. If the enemy has an abundance of guns but is low on ammunition then burning a warehouse full of guns will not count for much whereas burning a warehouse full of ammunition would be a vital blow.

43. Each military action against the enemy must be planned in such a manner that the amount of ammunition and supplies captured are at least enough to replenish the amount expended in that action.

44. Both offensive and defensive guerrilla activity is vitally dependent upon accurate knowledge of the enemy's strength, location, movements and so far as possible his intentions which is usually best obtained first hand by guerrilla scouts.

45. In the event that troops have settled down in the guerrilla area for a long and routine occupation, efforts should be made to determine whether or not they are completely loyal to the foreign ideology before antagonizing a possible potential ally.

46. The guerrilla must be continuously imagining himself in the shoes of his enemy. He must get to know how the enemy is likely to react in any given situation. He must be able to guess what the enemy commander will expect his band to do next. In this way he can often anticipate what the enemy will do. By then acting in some totally unexpected manner he can continuously catch the enemy in a series of embarrassing situations.

47. Guerrilla forces must remain widely dispersed throughout the entire area of enemy occupation. They must never accumulate in large numbers in a given area that the enemy can surround and eventually starve them out or gradually close in on them.

48. Guerrilla forces must be always alert to possible anti-guerrilla action that may be taken against them and constantly prepared to take suitable evasive action.

49. The guerrilla bands most essential function is to guarantee its own continuation. The very existence of the guerrilla band requires the enemy to guard against them and in so doing they are drained of manpower, supplies and equipment which the enemy forces might be needing badly in some other area.

50. Clear-cut victory is seldom possible either with or against guerrilla warfare-- the side that holds out longest will be the ultimate winner.

Please fill out and return to your assigned mail drop as quickly as possible. If you have not yet been assigned a regular mail drop, Mail to: P. O. Box 5791, San Diego, California 92105.

CODE NAME OR IDENTIFICATION NUMBER: \_\_\_\_\_

ADDRESS: \_\_\_\_\_ ZIP CODE: \_\_\_\_\_  
(Only if changed from last month)

BASIC CORRESPONDENCE TRAINING PROGRAM: (Enclose \$3.00 for each program)

- Intelligence       Security       Propaganda       Recruiting

Special Note: Each program must be ordered only upon completion of the prior program. Enclose payment when ordering each program.

SECRET ARMY ORGANIZATION MATERIALS:

- S. A. O. Stickers (50 for \$1.00)       S. A. O. Leaflets (50 for \$1.00)

Other Materials Needed: \_\_\_\_\_  
(Recruiting forms, Histories, Etc.)

S. A. O. DUES FOR \_\_\_\_\_ CONTRIBUTION TO S. A. O. \_\_\_\_\_

S. A. O. DUES FOR \_\_\_\_\_ MATERIALS \_\_\_\_\_

TOTAL ENCLOSED \_\_\_\_\_

DESCRIBE BRIEFLY YOUR ACTIVITIES PERTAINING TO THE ORGANIZATION DURING THE PAST MONTH:

# SECRET RECIPES

HOME-MADE EXPEDIENTS

## CHERRY BOMB

12 powders from cherry bombs  
1 fuse from cherry bomb  
one snuff can 2" high and 1" across  
about 50 bebes

After powder and bebes are in can, put lid on. Take ice pick, punch hole in top of lid. Slip fuse in. Then cover can completely with airplane glue around the base of the fuse to hold in place better when thrown.

## PLASTIC

Potassium Chlorate  
Petroleum Jelly (Vaseline)  
A round wooden stick or rolling pin

Spread the Potassium Chlorate thinly on a hard surface. Roll the round stick (rolling pin) over the crystals to crush them into a very fine powder (until it looks like face powder). Take 9 parts of the powdered Potassium Chlorate and one part of vaseline, and knead them together until a uniform paste is obtained. Detonate with a blasting cap or with a .30 caliber fused blank.

## BLACK POWDER

Potassium Nitrate - 25 parts  
Charcoal - 3 parts  
Sulphur - 2 parts

Dissolve the Potassium Nitrate in an equal amount of water. Pulverize the charcoal and sulphur, and add the Potassium Nitrate solution to obtain a thoroughly wet paste. Allow to dry.

## FAST BURNING FUSE

Twist soft cotten string into three strands. Moisten black powder to form a paste and rub the paste into the twisted string. Burns 30 to 40 inches per minute.

## SLOW BURNING FUSE

Dissolve one part of Potassium Nitrate or Potassium Chlorate and one part of sugar (granulated) in two parts of hot water. Soak the string in this solution. Twist the string into three strands and allow to dry. Burns about 2 inches per minute.

## FUSES

Fuses can be made by soaking course paper in a solution of gun powder and acetone (nail polish remover) overnight, then drying. Cut strips and twist together. Also, by coating a cotton string with a sticky substance, then dipping into gunpowder, coating all surfaces. A time delay fuse that can be used without a match is made as follows: Make a small pile of potassium permanganate and make a small pile of it on the ground, making a hole in the center of it. Next pour in the hole about an equal amount of straight glycerine. A flash will occur in about one minute. This method is best used when gun powder has to be used as a fuse... or for starting fires.

## PACKAGE BOMB

mouse trap  
electrical wire  
box or package

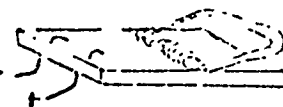
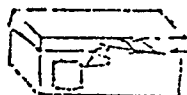

The mouse trap is the trigger. When the box is opened, the trap will close and contact on two electrical wires.

### JELLIED GASOLINE

Pour the contents of one bottle (1 pint 3 oz.) of Dynamo concentrated liquid laundry detergent into a bucket or large mouthed can of about two to five gallon size. Fill the detergent bottle twice, shaking well to rinse it out with gasoline (any grade) and add it to the detergent. You will now have about 3 1/2 pints (57 oz) of material in the bucket. The detergent will be at the bottom and the gasoline on the top. Stir this rapidly with a wooden or wire paddle so as to mix in as much air as possible. Soon the mixture will take on the appearance of soft vasoline.

Now add in a gallon of gasoline and stir again until the mixture thickens. At this point, transfer the mixture to clean containers. No return type beer and soda bottles are ideal. For chemical land mines, use two gallon oil cans. The container should be filled approximately one third full of the mixture. Finish filling the container with gasoline leaving a little air space at the top. Place your finger or hand over the opening and shake well until the gasoline and mixture amalgamate. You can verify this by looking at the finger or hand occasionally to see if a film of jellied gasoline about an eighth of an inch thick clings to it. When proper consistency is reached, the bottles may be capped or corked. Cans should have tight fitting lids screwed on. This may be stored up to two weeks. Tie a rag around the neck of each bottle being careful not to leave the ends of the rag too long or too loose.

If necessary, this mixture can be "cut" 50% with gasoline or other petroleum product. The tendency to "cling" will suffer slightly, but consistency can be maintained by pouring off the excess gasoline whenever the detergent refuses to "take" any more.

To use, saturate the rag with gasoline or the mixture from the bottle. Keep the flammable material off of your person and clothing. Light the rag with match or cigarette lighter and immediately serve. Throw hard against a solid object such as masonry, concrete, or metal. In using the mixture in a chemical land mine, wrap three or four wraps of primacord around a two gallon can and tie the primacord under the can around a pound of explosive. This may be exploded either electrically or by a percussion such as a booby trap device or anti-personnel fuse. Do not contact wires to the blasting machine until after you have carefully removed all traces of your work and camouflaged the position. Never use any plastic article in contact with the above mixture.

### ARMOUR PIERCING BULLETS

Reloaders can drop a 25 caliber steel ball bearing into a .30 caliber bullet mould and thus have an armour piercing bullet. It is also a duplex bullet as the ball bearing will keep going after the lead has stopped.

### SHRAPNEL MINE

Length of stove pipe  
nuts, bolts, buck shot, etc.  
wood  
dynamite  
fuse

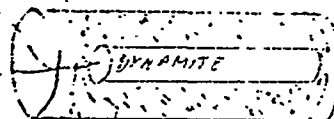

Block both ends of the stove pipe with wood after the stick of dynamite has been placed in the center and the nuts, bolts, and other shrapnel material has been placed around the dynamite. Hang from a tree.

NOTES:

Date prepared

6/21/72

Date received

5/19/72

Received from (name or symbol number)

INFORMANT

Received by

SA Robert Schachner

Method of delivery (check appropriate blocks)

in person

by telephone

by mail

orally

recording device

written by Informant

If orally furnished and reduced to writing by Agent:

Date

Dictated

5/24/72 to IMB

Transcribed

5/29/72

Authenticated by Informant

6/20/72

Date of Report

5/19/72

Date(s) of activity

5/72

Brief description of activity or material

SAD activity

File where original is located if not attached

170-270A-45

\* INDIVIDUALS DESIGNATED BY AN ASTERISK (\*) ONLY ATTENDED A MEETING AND DID NOT ACTIVELY PARTICIPATE. VIOLENCE OR REVOLUTIONARY ACTIVITIES WERE NOT DISCUSSED.

Information recorded on a card index by \_\_\_\_\_ on date \_\_\_\_\_.

Remarks:

1-SAN DIEGO (157-2815) (RM)

Q Am lurb

1-157-1173

1-157-1101

Block Stamp

157-2815-122

SEARCHED \_\_\_\_\_ INDEXED \_\_\_\_\_

SERIALIZED \_\_\_\_\_ FILED \_\_\_\_\_

JUL 2 1972

FBI - SAN DIEGO

Hooper DJ

Phoenix, Arizona  
May 19, 1972

Information was obtained that Captain STAN WILLIAMS' check sent to the Secret Army Organization, San Diego, California, for payment of membership fees and dues, has been cashed and returned. Photostat of the check is attached hereto. It is noted check is endorsed, "Secret Army Organization, Sam Collins".

*INFORMANT*

6123  
GRAND NATIONAL  
SERVICE BANK

SCOTTSDALE OFFICE SCOTTSDALE, ARIZONA	DATE 3-15-72	91-314 122
PAY TO THE ORDER OF General Electric Organizational		
for maintenance		DOLLARS
<i>J. Williams</i>		
⑆1221⑆0314⑆	9263⑆0500⑆	⑆0000004100⑆





Date prepared

6/2/72

Date received

6/2/72

Received from (name or symbol number)

INFORMANT

Received by

SA CLARENCE L. GRANDALL

Method of delivery (check appropriate blocks)

in person     by telephone     by mail     orally     recording device     written by Informant

If orally furnished and reduced to writing by Agent:

Date

Date of Report

Dictated \_\_\_\_\_ to \_\_\_\_\_

Transcribed \_\_\_\_\_

Authenticated  
by Informant \_\_\_\_\_

Date(s) of activity

May 1972

Brief description of activity or material

Undated communications from SAM, namely,

JERRY DAVIS, San Diego, California,

concerning the SECRET ARMY ORGANIZATION

File where original is located if not attached

Originals returned to sou

\* INDIVIDUALS DESIGNATED BY AN ASTERISK (\*) ONLY ATTENDED A MEETING AND DID NOT ACTIVELY PARTICIPATE. VIOLENCE OR REVOLUTIONARY ACTIVITIES WERE NOT DISCUSSED.

Information recorded on a card index by \_\_\_\_\_ on date \_\_\_\_\_

Remarks:

Informant furnished the printed material which is attached hereto in Xerox form.

(ANY UTILIZATION OF THIS INFORMATION IN BUREAU REPORTS OR ITEMS MUST BE PARAPHRASED ADEQUATELY TO PROTECT THE INFORMANT.)

- 2 - Phoenix  
    (lcc 170-37-A)  
    (lcc 157-1173) SAO
- ② - San Diego  
    (lcc 157-2815) SAO  
    (lcc 157-3001) DAVIS

Block Stamp

157-2815-113

SEARCHED _____	INDEXED _____
SERIALIZED _____	FILED _____
JUN 7 1972	
FBI - SAN DIEGO	

*Clarence L. Grandall*

We granted the interview with the newspaper women I wrote you about. It should be out in a week or so, will send you a copy when its printed. We really put on a show for this girl, the secret contact, meeting place, radio communications, etc. The whole secret agent bit. During the interview she told us that the police had been out to see her after the first article. The San Diego Police wanted to know who she had talked too (we mailed the information for the first story to her). Later she had a visit from the feds asking her if she would infiltrate our organization for them. They must be getting hard-up for information when they have to go out and try to recruit people. This girl might be alright, but we are not going to trust her anyway. Its getting where I can count the people I trust on one hand and still have four fingers left.

Enclosed are three more letters for you, two wrong addresses, and one hate letter. Just so you will not think that you are the only one who gets these letters, I have enclosed one we received a few days ago. If the lirtecture we send out gets these types ( religous nuts and love creeps) so upset, then we must be on the right track.

SAM

Sorry about the delay in mailing you the May Bulletins, we just did not have the funds to pay for the printing until now. If nothing go's wrong we will be able to print-up the Security Training Program and your Mail Drop Transfer Letter this coming weekend. Hope to have the funds available for the Special Bulletin the following weekend.

I have enclosed a copy of the first part of the newspaper interview we gave. Will send you the other articles as they are printed. The way we understand it is that it will be a three piece article, The first one is not to bad. We have been receiving articles from other papers in the area too, but they have all been of the smear type.

On the subject of bulletins; when would you be able to write another one, and what subject would you be covering. Also would like for you to write the foremat (one or two pages) for some of the bulletins. We have been trying to keep the bulletins between 10 to 12 pages long. The only original bulletin we have put-out so far is the one you wrote on lock picking. I am fairly good at stealing material and rewriting it, but have trouble writing anything orginal.

Would like to set-up another meeting with you in the near future. There are some things we need to talk over with you that we cannot put in a letter. Let me know when you will have some time off and we will try to make some arrangements.

SAM

The shit hit the fan here this week again. We put out a Special Bulletin containing information about some of the San Diego City officials. The fuzz was out to see me two days after we mailed it out. They told me that the city had assigned two detectives on full time duty to keep an eye on SAO activities. The left fired bombed one of their own cars and tried to blame it on us, plus one of the city councilmen received a threatening phone call. The detectives told me that one high ranking left winger had call the police and demanded they assign him policemen to protect him.

We have been making some real good headway in setting up new groups in California. Some of the new people we are getting are working out real well, others are the hanger-on types. We are having a little trouble with some DePugh types up in Los Angeles. They don't like the idea of us organizing up there. If they start any trouble we will give them more than they are looking for, you can bet on that.

We should have the May Underground Bulletin ready to mail out to you by the first of the month. We are reprinting the Communications Bulletin. Rewrote it to fit our group. If we have the money I will try to print up both of the letters at the same time.

Sorry to here about you being out of work again, no how it is trying to make ends meet. I can only draw eight unemployment checks then I will have to go back to work. Sure wish some fat cat would finance a few of us to work full time on organization activities. Guess there is no danger of that thou.

SAM

Date prepared

3/21/72

Date received

3/21/72

Received from (name or symbol number)

INFORMANT

Received by

SA CLARENCE L. GRANDALL

Method of delivery (check appropriate blocks)

in person     by telephone     by mail     orally     recording device     written by Informant

If orally furnished and reduced to writing by Agent:

Date

Dictated \_\_\_\_\_ to \_\_\_\_\_

Transcribed \_\_\_\_\_

Authenticated by Informant \_\_\_\_\_

Date of Report

Date(s) of activity

current

Brief description of activity or material

See below

File where original is located if not attached

Orig. returned to source

\* INDIVIDUALS DESIGNATED BY AN ASTERISK (\*) ONLY ATTENDED A MEETING AND DID NOT ACTIVELY PARTICIPATE. VIOLENCE OR REVOLUTIONARY ACTIVITIES WERE NOT DISCUSSED.

Information recorded on a card index by \_\_\_\_\_ on date \_\_\_\_\_

Remarks:

Source advised that information has come into his possession in the form of two undated letters in photocopy form addressed to "71501" from "71401". Copies of these letters, which pertain to security measures being taken by an organization known as SECRET ARMY ORGANIZATION, are attached hereto. Source has also determined that the code number 71501 is assigned to one EV MOORE in Phoenix, and that the code number 71401 is assigned to one SAM DAVIS in San Diego by the SAO.

2 - Phoenix

(1 - 170-37-A)

(1 - 157-1173)

② - San Diego

(1 - SAO) 157-2815

(1 - Sam Davis)

157-2815-112

Block Stamp

SEARCHED _____	INDEXED _____
SERIALIZED _____	FILED _____
JUN 15 - 1972	
FBI - SAN DIEGO	
<i>Christensen</i>	

To: 71501

The March Underground Bulletin should be in the mail to you by 14th at the latest. Will send you 25 copies of it, if you need more write. Will send you the Review Questions for the book Guerrilla at the same time. Also will send you a few more copies of the book. I have set up a front to buy books and am trying to order a lot of the Guerrilla book.

Am writing to the printing house that handled War of Wits, to see if maybe they could locate a supply of that book. I know that the hope of finding any is not good, but feel its the best all around book on underground warfare.

When are you going to be able to have the bulletin that you are writing ready? Is it going to be ready to sent to the printer when you let us have it, or are we going to have to retype it and do the lay out work? If you can have it ready to go right to the printer it will be a big help. We also need to know how many pages it is going to run. If its not at least 10 pages long we are going to need time to write up some additional material to fill out the bulletin. Some where between 10 to 14 pages would be ideal.

If you do not have enough material on locks to fill out that many pages fill free to use any other material that deals with underground warfare. You have copies of our other bulletins so you know the many areas that we have not covered.

I kept a copy of the names and addresses of the two members we sent you. Let me know that you received there records and I will destroy the names and addresses. The membership applications I sent you on these two members are copies I made. We always destroy the ones members send in. That way there is no application with a members name signed to it. Are you going to assign these two a mail drop in your area or keep them using the one  here. If you keep them assigned to a mail drop in our area we will assign them a new mail drop that we will use only for members in your state. That way we can send you there letters unopen by us.

If possible drop one of the tables you are keeping for us. We will only need three. One of the guys will not be able to make it. If you can not drop the table we will pay for it any way.

71101

*Er Moore*  
TO: 7I50I

FROM: 7I40I

Sorry about the delay in contacting you, but I have been real busy since getting back. As you will note I have addressed this letter to 7I50I. This will be your number and the 7I40I is mine. Have assigned you this block of numbers to use:

7I502 to 7I550

I suggest that you start with 7I502 and work up when assigning numbers to people you recruit in person or by an agent of yours. When a person from your area writes to us over here to join up we will assign them a number out of another block of numbers and turn them over to you.

As you will note on the Organizational Correspondence To Members (enclosed) that a book "Guerrilla" by Charles W. Thayer is listed. I am enclosing two copies of this book to sent the two members: 7I404 and 7I412 that I am turning over to you at this time. Sent the books to them when they order the Intelligence Training Program. We only have a very small amount of these books on hand at present. I am ordering another bunch and will sent you additional copies when I get them.

If you know of other paperback pocket books of this type we may be able to use in our training programs let me know. I plan to print a set of review questions to go with the Intelligence Training Program that will deal with the book. Similar to the one you wrote on the old training program, I liked yours very much.

Both of the members I am turning over are assigned mail drop 00I; Artist Supply. If you wish to assign them another mail drop in your area feel free to do so. If not they can send in their reports, dues, etc. to 00I and we in return will send them on to you at Mail Drop 005, the number assigned to the address this letter is being mailed to.

We have decided to try this break down on money:

Dues \$3 a month you keep \$2 and send us \$1

Membership Fee you keep \$3 and send us \$2

\*Contributions if sent in with report form you keep half and us half

\*This is only for contributions members send in on report forms. Any additional money you can raise in your area to support the organization is to be kept by you to support your state organization.

If there is any additional information or help we can give you please let us know.

Yours for Freedom

7I40I

*Sam Davis*

SECURITY CLASSIFICATION GUIDELINES - PERSONNEL STATUS RATINGS

- NOVICE - Classification for new members who have not proven themselves or completed any of the Basic Training Programs.
- TRAINEE - Classification for those members who have completed at least one of the Basic Training Programs or performed some other routine operation.
- MEMBER (D) - Classification for personnel who have been members for a period of at least six months but have not completed the Basic Training Programs or taken part in any but routine operations.
- MEMBER (C) - Classification for members who have completed the Basic Training Programs, but have not taken part in "Special Operations".
- MEMBER (B) - Classification for members who have not completed the Basic Training Programs, but have proven themselves by taking part in "Special Operations".
- MEMBER (A) - Classification reserved for members who have completed their Basic Training Programs and taken part in "Special Operations". All members in this classification should automatically rate the rank of Sergeant.
- LEADER (D) - Classification for Team Leaders who have not proven themselves or organized their units to the excepted level. Team Leaders in this classification should be assigned the rank of Second Lieutenant.
- LEADER (C) - Classification for Group Leaders who have proven themselves and organized their units to the proper level. Team Leaders in this classification should be assigned the rank of First Lieutenant.
- LEADER (B) - Classification for Group Leaders who have not proven themselves or organized their units to the proper level. Group Leaders in this classification should be assigned the rank of First Lieutenant.
- LEADER (A) - Classification for Group Leaders who have proven themselves and organized their units to the excepted level. Group Leaders in this classification should be assigned the rank of Captain.
- DIRECTOR - Classification for Network Leaders. All personnel assigned this classification must have proven themselves beyond any doubt. All Network Directors rate a rank of at least Captain.
- COORDINATOR - Classification for Regional or State Leaders. All personnel in this classification must have proven themselves beyond question. Coordinators rate a rank of at least Captain.



SUBJECT: Organizational Correspondence To Members (Outline)

1. Letter To Prospective Member  
History Of The Secret Army Organization  
To Prospective Members Of The Secret Army Organization  
Membership Application Form  
Join The Secret Army Organization Leaflet (one)
2. Identification Number & Mail Drop Letter  
Practical Security Measures  
The Combat Team
3. Training Program Letter  
Preliminary Training Lesson
  - a. Join The Secret Army Organization Leaflets (5)
4. Intelligence Training Program
  - a. Book "Guerrilla" By Charles W. Thayer
5. Security Training Program
  - a. Practical Security Measures
6. Propaganda Training Program
  - a. Join The Secret Army Organization Leaflet
  - b. How To Organize An Underground Army Leaflet
7. Recruiting Training Program
  - a. Prospect Data Forms (5)

Special Instructions:

The above order should be followed in sending out the listed materials. Extra material such as organizational bulletins on Weapons, Personal Equipment, and Booby Traps should be sent to the new members to fill in spaces between the regular correspondence. The member should also be sent each new monthly bulletin. Our main concern during the Correspondence Phase will be in keeping up the interest of the new member until we can contact them personally, or put them in contact with other members. The best way to do this is to keep them busy with printed material.

Date prepared  
5/10/72

Date received: 5/10/72  
Received from (name or symbol number): INFORMANT  
Received by: SA CLARENCE L. GRANDALL

Method of delivery (check appropriate blocks)  
 in person  by telephone  by mail  orally  recording device  written by Informant

If orally furnished and reduced to writing by Agent:  
Date \_\_\_\_\_  
Dictated \_\_\_\_\_ to \_\_\_\_\_  
Transcribed \_\_\_\_\_  
Authenticated by Informant \_\_\_\_\_

Date of Report  
April 1972

Date(s) of activity  
April 1972

Brief description of activity or material  
Source furnished Bulletin material pertaining to the SA<sup>9</sup> for the month of April, 1972.

File where original is located if not attached  
170-37-A

\* INDIVIDUALS DESIGNATED BY AN ASTERISK (\*) ONLY ATTENDED A MEETING AND DID NOT ACTIVELY PARTICIPATE. VIOLENCE OR REVOLUTIONARY ACTIVITIES WERE NOT DISCUSSED.  
 Information recorded on a card index by \_\_\_\_\_ on date \_\_\_\_\_

Remarks:  
Source furnished the April 1972 "Underground Bulletin" of the Secret Army Organization. The subject material in this bulletin, which is attached hereto, is "the forced entry into buildings, as it applies to underground warfare,"---- and "ammonium nitrate as an explosive."  
Source advised that "Coordinators and Network Directors" are to submit a monthly report to SAO headquarters via the regular mail drop or by most secure route. This report tabulates the number of members in an area, number of bulletins received from headquarters, number of bulletins distributed, number of new members recruited,

- 1 - 170-37-A
- 1 - 157-1173

1 - San Diego (info) (157-2815)

Block Stamp

157-1173-105  
SEARCHED \_\_\_\_\_ INDEXED \_\_\_\_\_  
SERIALIZED \_\_\_\_\_ FILED \_\_\_\_\_  
MAY 23 1972  
FBI - SAN DIEGO  
*Christensen*

identification numbers assigned, amount of money collected in dues and contributions, and amount submitted to headquarters in San Diego.

Source advised that the SAO is starting out with the policy of retaining sufficient funds in the hands of the various coordinators whereby they can operate an independent organization, so to speak. The only expenses of SAO at headquarters level involves the printing of bulletins and the renting of Post Office boxes.

The State Coordinator at Phoenix, Arizona is currently under instruction to include the State of New Mexico in his recruiting efforts.

Source advised that some of the bulletin material emanating from SAO headquarters in San Diego is being disseminated over the signature or name "CAPTAIN SAM COLLINS." The latter is regarded as a code name.

UNITED STATES GOVERNMENT

# Memorandum

TO : SAC, SAN DIEGO (157-2815)

DATE: 4/27/72

FROM : SA STEVEN L. CHRISTENSEN

SUBJECT: SECRET ARMY ORGANIZATION  
EM - SAO

The attached bulletin of the SAO was made available by Deputy Sheriff HAL TRIMBLE on 4/27/72. He advised it is a copy of a bulletin received by the Lemon Grove branch of the Southern California First National Bank. He added that many more copies of the bulletin had been received by various groups and individuals around the San Diego area.

1 - SD 15702815  
SLC/slc  
(1)

157-2815-81

SEARCHED _____	INDEXED _____
SERIALIZED <u>  /  </u>	FILED <u>  /  </u>
APR 27 1972	
FBI - SAN DIEGO	
<i>[Signature]</i>	

*(Inlet)*

Buy U.S. Savings Bonds Regularly on the Payroll Savings Plan

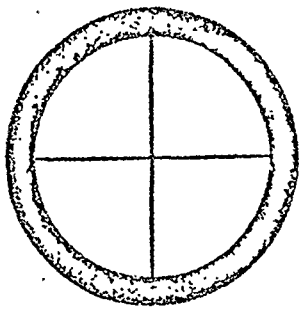

# SECRET ARMY ORGANIZATION

## SPECIAL BULLETIN

---

---

As most of the citizens of San Diego County are no doubt aware many liberals, pinks, reds, and other fuzzy thinking types will be bringing themselves and their gas masks here in August for a "peaceful" protest during the Republican National Convention.

While local left-wing groups are preparing for the "peaceful" protest by stock piling gas masks, flak vests, firearms and ammunition the city of San Diego is rolling out the red carpet ( aptly named ) for these professional revolutionaries. Yes, as strange as it may seem some members of the San Diego City government are going out of their way to make sure these communist revolutionaries are made welcome here.

Mavourneen O'Connor, twin sister of City Councilwoman MAUREEN O'CONNOR (Home address: 5821 Laurretta, San Diego, Telephone: 295-8693), is one of the more prominent members of the community who is engaged in this strange behavior. Miss O'Connor is employed by the Southern California First National Bank as a Community Relations officer, taking time off last year to run the campaign of her sister Maureen.

Her new duties are setting up a central headquarters for the protestors to use during the convention. The Unconventional Center (also aptly named) is to be this headquarters. Located at the corner of Jefferson and Riley Streets just six blocks from the Sports Arena the site of the convention, the 7,800 foot warehouse is being stocked with the expected services that may be needed by the protestors. These include; transportation, facilities for the printing of propaganda, a telephone message center, legal aid services, and a medical aid center. These last two are odd, considering its to be a "peaceful" protest.

The bill for all this is being picked up by the Southern California First National Bank who's chairman is ROBERT OSCAR PETERSON (Home address: 567 Gage Lane, San Diego, Telephone: 222-4835). Mr. Peterson has not always been a supporter of these left-wing type activities, in fact as late as January 1970 he was on the receiving end of a smear article done by the San Diego STREET JOURNAL. The Street Journal for those citizens lucky enough not to have seen an issue is one of many pro-communist underground newspapers that operate in the San Diego area.

The article on Peterson exposed his business dealings with a number of large companies; Foodmaker Corporation (owners of Jack In The Box drive-ins), and the Ralston Purina Corporation among others. At the end of the article the Street Journal made the statement that a covering article would expose other of his business dealings.

Needless to say, the article never appeared. One can only wonder now that Mr. Peterson is supporting these same type of people if some kind of blackmail was not used. Many of the members of the staff of the Street Journal live at a commune supported by the paper at 173 4th Avenue in Chula Vista.

The first news conference of the Unconventional Center was attended by these noted prominent city officials: Councilmen Gil Johnson and Jim Bates, and city manager Kimball Moore. Others not quite so prominent attending were a long haired representative from the Community Congress and Shari Whitehead, 24, a representative from the Convention Coalition. The Convention Coalition is the group that plans to coordinate the activities of protestors expected to arrive for the convention. While Mayor Wilson was not able to attend this meeting in person he later made this comment on Mavourneen O'Connor's pro-demonstration activities " I commend her for her energy and her efforts ".

Of all the organizations preparing to protest at the convention the Convention Coalition is probably the most active. Some of the leaders of the coalition are: Peter Bohmer, the off again, on again, economics professor at San Diego State, seen recently at 4931 Coronado Street, San Diego; Michael Kenneth, address 3777 Fairmont, San Diego; Pam Williams, also seen at the Coronado Street address; and last, but not least, Doug Porter, recently seen at 2445 Albatross, San Diego. Headquarters for the coalition are at 309 6th Street in San Diego.

While the Intelligence Branch of the San Diego Police Department has reported to city officials the militant activities (stock piling weapons and explosives) of these leftist groups the city fathers have annoy all warnings. Instead of spending every dime the city can spare on weapons and equipment to help the police put down a possible riot the powers to be believe the money can better be spent for SENSITIVITY TRAINING.

While the left is planing a full scale battle the public officials of San Diego spend the tax payers money on sensitivity training for the police department. And guess who they pick to teach this garbage, a foreign born (Iran) Professor of Psychology who was kicked off the staff at San Diego State because of his profanity and teaching of left-wing views. JAUAD EMAMI was a Assistant Professor at SDS before having been removed, he and his wife Minou live at 3850 American Avenue in La Mesa. The 5'10", 190 pound, black hair, brown eye professor was educated at UCLA and the University of Arizona. Emami drives a white van (California ZMJ 481) and is payed \$25 an hour to teach our policemen to talk nice to these creeps that will be invading San Diego in August.

Instead of hiring this fuzzy headed professor the SAO believes the City of San Diego should have hired Lieutenant Cally, then at least the police would have received some expert training on how to handled RED TRAITORS.

UNITED STATES GOVERNMENT

# Memorandum

TO : SAC, SAN DIEGO (157-2815)

DATE: 3/31/72

FROM: SAC, LAS VEGAS (157-997) -P-

SUBJECT: SECRET ARMY ORGANIZATION (SAO)  
EM - SAO

OO San Diego

Rereport SA STEVEN L. CHRISTENSEN at San Diego,  
dated 1/21/72.

On 2/8/72, a review of the Las Vegas City Directory disclosed that telephone number 384-2046 is listed as being the number of EDWARD B. JOHNSON, 2400 Sunrise, Apt. 12, Las Vegas, Nevada.

On the same date, a review of the City Directory concerning telephone number 642-4467 was negative. Numerous attempts to contact anyone at this number were met with negative results.

On 2/28/72 **THIRD AGENCY**  
Las Vegas, Nevada, advised that P.O. Box 2191 was originally rented on 9/6/68 by JULIUS STEINER, 2004 Brady, Las Vegas, Nevada. STEINER identified himself by means of California driver's license M-433240.

On 3/10/72, a check of the files of the Las Vegas Police Department was negative concerning EDWARD B. JOHNSON or JULIUS STEINER. Las Vegas indices were also negative concerning these individuals.

On 3/10/72 and 3/22/72, spot checks at 2400 Sunrise and 2004 Brady were negative and no automobiles were observed registered to either STEINER or JOHNSON.

On 3/23/72, the individuals identified below were furnished background information concerning SAO, and all

- 2 - San Diego
- 2 - Sacramento
- 2 - Las Vegas
- (1 - 157-553)

WLK:tlw  
(6)



157-2815-57

SEARCHED.....	INDEXED.....
SERIALIZED.....	FILED.....
APR 2 - 1972	
FBI - SAN DIEGO	
<i>Christensen</i>	

Buy U.S. Savings Bonds Regularly on the Payroll Savings Plan

LV 157-997

advised that no information concerning this organization has come to their attention:

Lt. JOHN CONNOR, Las Vegas Police Department,  
Intelligence Unit.

Detective JOHN HOLLAND, North Las Vegas Police  
Department.

Lt. MARTIN, Clark County Sheriff's Office.

These individuals stated that in the event any information is received by their respective department concerning the SAO or any individuals connected with it, such information would be furnished to the FBI.

LEADS:

SACRAMENTO DIVISION

At Sacramento, California:

Will review records of Department of Motor Vehicles concerning JULIUS STEINER, DL #M-433240, for background and descriptive data.

LAS VEGAS DIVISION

At Las Vegas, Nevada:

1. Will continue efforts to identify ED (LNU) and attempt to determine if he is identical to EDWARD B. JOHNSON, 2400 Sunrise, Apt. 12.

2. Will attempt to further identify JULIUS STEINER, 2004 Brady, the holder of P. O. Box 2191.

3. Will, following receipt of the results of subpoena to Central Telephone Company, Las Vegas, report the identity of the subscriber to telephone number 642-4467 and determine if this person is identical to JACK DOYLE or JACK CONAN DOYLE, JR.



J. H. THOMPSON  
ES. E. BUNKER  
ERT. G. SULLIVAN  
ALD. McGRATH 2

THOMPSON, BUNKER, SULLIVAN & McGRATH  
ATTORNEYS AT LAW  
814 SAN DIEGO TRUST & SAVINGS BUILDING  
SAN DIEGO, CALIFORNIA 92101  
TELEPHONE 234-6781

March 22, 1972

Special Agent Gibson  
Federal Bureau of Investigation  
3211 Fifth Avenue  
San Diego, California 92103

Dear Mr. Gibson:

As I am a former FBI Agent, one of my friends forwarded to me information which she received through the mail from a "Secret Army Organization." You probably have this background information, but if not, I felt that it deserves your consideration and attention.

Mrs. Lusk does not know why the literature was forwarded to her. She is employed by the Pacific Telephone Company and several weeks ago she wrote a Letter to the Editor which was published in the Union Tribune on the subject of amnesty for the draft dodgers.

If you desire any further information concerning this matter, please give me a call.

Very truly yours,

*James E. Bunker*  
James E. Bunker

JEB/hi  
Encs:

157-2815-54

SEARCHED	INDEXED
SERIALIZED	FILED
MAR 28 1972	
FBI - SAN DIEGO	
<i>Christina</i>	

**SECRET ARMY ORGANIZATION**  
**GENERAL HEADQUARTERS**



Dear Fellow American,

At the request of a mutual friend we are sending you this invitation to join the Secret Army Organization. Those of us who have been members for some time sincerely believe that our organization can be of real value in preserving for future generations the land of freedom and opportunity which our forefathers handed down to us.

It is the belief of our organization that the communist-socialist conspiracy has infiltrated the United States Government to such an extent that the American people cannot rely on this country's elected leaders to protect them from communist domination and slavery.

We believe that the time will come when the American people will have to fight for their lives and their liberty. In this belief, we have formed in advance a secret underground army with but one objective, to defend our constitutional republic and to help our fellow Americans to do the same.

We do not want lukewarm members. We are an organization of people willing to make any sacrifice necessary for our country. If you feel the same way, we invite you to join us.

**SECRET ARMY ORGANIZATION**

157-2815-53

SEARCHED _____	INDEXED _____
SERIALIZED _____	FILED _____
MAR 28 1972	
FBI—SAN DIEGO	
<i>Christensen</i>	<i>me</i>

# JOIN THE SECRET ARMY ORGANIZATION

An organization of loyal Americans  
dedicated to the preservation of both  
national and individual freedom.

1. To prepare the means of personal defense and survival in case of enemy attack.
2. To resist and expose the spread of communist influence and propaganda within our own national boundaries.
3. To investigate by means of our own secret memberships the infiltration of communist sympathizers into American organizations of government, business, labor, religion and education.
4. To resist by any and all means the passage of laws which regulate the private ownership of firearms or which detract from the individual's ability to defend his own family and personal property.
5. To promote knowledge and skill in the use of arms by our own members and by the general public.
6. To form in advance of actual need a secret underground organization equipped to spy upon, harass and destroy troops of any States territory.
7. To lend assistance and support wherever possible to other resistance organizations, domestic or foreign, opposing communist expansion or subversion.
8. To pursue these programs as private citizens motivated only by patriotism and to remain entirely free of government subsidies or control.

# History of the Secret Army Organization

One early morning in February, 1970, a group of six Minutemen leaders from four states met secretly in Northern Arizona to discuss the crisis that the arrest and imprisonment of two top Minutemen leaders and the assassination of a third had brought on the organization. Although some of these men had met before in their roles as Minutemen group leaders, others were meeting for the first time.

After much discussion, two principal points were agreed upon. First, that the Minutemen as a national coordination organization of militant right-wing groups had effectively been destroyed by the pro-communist elements inside the Justice Department. While individual units still existed throughout the country, few had the financial support or leadership to be really effective. Second, that the need for such a coordinating organization was greater than ever in view of the increased revolutionary activity by communists in the United States.

With these two points in mind, suggestions were put forward on a course of action to be followed. After a meeting that lasted all that day and far into the next morning, an overall plan of action was finally agreed upon. All present agreed to merge their individual units together and form a new organization under the command of one leader elected from among themselves, with the other five to be members of a General Staff that would advise and assist the new leader.

While retaining the basic programs and policies of the Minutemen, it was decided that not only should this new organization have a different name, but also a completely new chain of command and organizational structure. If the new organization was going to survive the attacks that befell the old one, a whole new approach would be needed. Never again could the arrest or death of a few leaders be allowed to cripple the entire organization.

For this reason it was decided that only a highly disciplined military type organization with a definite chain of command would have any chance of success. This then, was the beginning of the Secret Army Organization. Beginning with an original force of hard core patriots that numbered fewer than two hundred, the Secret Army Organization began the job of picking up the pieces and continuing to fight for national and individual freedom. Using this cadre of dedicated personnel as a nucleus, the S. A. O. has been recruiting and training new members in the skills they will need as the freedom fighters of tomorrow.

The leaders of the S. A. O. have no idea of fighting a last ditch stand. We have no desire to commit suicide ourselves or to let our members do so. We have a strategy which we believe will ultimately lead to victory. Only one thing is essential. We must start preparing and training NOW! We of the S. A. O. believe that our country is worthy of any sacrifice. If you feel the same way, we invite you to join us.

# APPLICATION FOR MEMBERSHIP

NOTICE TO APPLICANT: All information on this form will be kept confidential. All records of members of the Secret Army Organization are stored in a way that they can be swiftly destroyed to keep them from falling into unauthorized hands.

Name \_\_\_\_\_ Sex \_\_\_\_\_ Age \_\_\_\_\_

Address \_\_\_\_\_ Marital Status \_\_\_\_\_  
(Street)

State \_\_\_\_\_ Wife's Name \_\_\_\_\_

Zip Code \_\_\_\_\_ Telephone \_\_\_\_\_

Date of Birth \_\_\_\_\_  
(Month) (Day) (Year)

Occupation \_\_\_\_\_ Education \_\_\_\_\_

Special Subjects Studied \_\_\_\_\_

Do You Speak or Read Any Foreign Language? \_\_\_\_\_

Veteran \_\_\_\_\_ Branch \_\_\_\_\_ Highest Rank \_\_\_\_\_

What Service Training Have You Had That You Feel Would Be Beneficial To This Organization? \_\_\_\_\_

Physical Description: Height \_\_\_\_\_ Weight \_\_\_\_\_ Color Eyes \_\_\_\_\_

Color Hair \_\_\_\_\_ Health: Good \_\_\_\_\_ Fair \_\_\_\_\_ Poor \_\_\_\_\_

Any Physical Disabilities or Limitations? \_\_\_\_\_

Any Public Speaking or Organizing Experience? \_\_\_\_\_ If Yes, Please Explain: \_\_\_\_\_

How Many Hours A Week Could You Devote To Working And Training With the S. A. O. ?

Hours \_\_\_\_\_ Best Time: AM \_\_\_\_\_ PM \_\_\_\_\_ Weekdays \_\_\_\_\_ Weekends \_\_\_\_\_

## CERTIFICATION

I am a loyal American Citizen dedicated to the defense and survival of the United States as a Constitutional Republic, free from all socialist and communist policies. Enclosed is my \$5.00 membership fee. I agree to pay \$3.00 each month to the Secret Army Organization as membership dues.

## To Prospective Members Of The SECRET ARMY ORGANIZATION

The Secret Army Organization is the most active, most completely dedicated and most selective in its membership of all the many patriotic organizations in America. We are willing to make any sacrifice for our country and we fully expect that some of us will have to make the ultimate sacrifice before victory is achieved. Our very lives depend on each other. There is no place in this organization for bunglers, playboys or lukewarm conservatives. If you join the Secret Army Organization, there might easily come a time that your life would depend on how competently some other member had learned his job.

Unless you are especially well informed on the domestic and world political situation, it is probable that you have a lot to learn about the present threat our nation faces. Unless you have had many years experience in actual underground warfare, there is undoubtedly a lot you can learn from the experts in our organization who have developed and supervised our training program.

### OUR NATION IS IN IMMEDIATE DANGER

It is possible that within a very few years, perhaps even within months, our nation could be conquered and enslaved by the communists. To prevent this we must know as much as possible about our enemies. Unless we know who they are and what they are doing we will not succeed in our efforts to maintain a free America.

### THE RESISTANCE MOVEMENT

In driving an invader from your land the resistance involved goes through three stages of development.

- 1) The Underground Network
- 2) Active Guerrilla Warfare
- 3) Open or Conventional Warfare

The conventional warfare stage uses everything in the way of weapons that the enemy does but must also have active guerrillas and underground agents working against the enemy, too. In the present state of military tactics conventional warfare cannot succeed unless these other two ingredients are used simultaneously.

The first step is to form an underground network. An active guerrilla system must have the support of an underground network of approximately three times its own size. This underground must supply the active guerrilla fighter with supplies, concealment, information, etc. An underground network starts with departments of intelligence, security and propaganda in that order.

Sabotage, espionage, subversion, infiltration, escape and evasion, training, clandestine fabrication of supplies, counterfeiting enemy documents, recruiting, communications and propaganda are other phases of underground activity. Each member of the Secret Army Organization, to be effective, must have a working knowledge of all these tactics as well as the military tactics more commonly associated with guerrilla activities.

## ASSIGNMENT TO UNITS

Many people that inquire about membership in the Secret Army Organization seem to have an idea that they will be immediately accepted into an active unit. Look at it this way. Suppose you had spent a year or more carefully recruiting and training until you had a hard hitting team where every individual was reliable, dedicated, and had confidence in his fellow unit members. Wouldn't it make you mad to have the national or regional organization assign some rank amateur to your unit that you you knew little or nothing about?

Before any new member is assigned to an active unit or to an important underground project, he must undergo a period of training. During this training he will be directed through the mails by an experienced member and some of his activities may be observed by other members without his knowledge. Only when a new member proves himself to be conscientious, trustworthy, self-disciplined and able to operate effectively alone will he be accepted as a "secure member" and invited to participate with other unit members in a teamwork operation.

## EXPENSES

Unfortunately, most good things don't come cheap. Although we make every effort to keep down the expense of membership in the Secret Army Organization, you must expect to pay your own way.

Dues to the Secret Army Organization are \$3.00 per month. This money is absolutely necessary for use to maintain our central files and headquarters, for postage and printing, to finance our extensive intelligence network, and to maintain training areas.

Each member will have other expenses depending on the type of activity he is engaged in. Every member will be expected to buy his own gun, ammunition and other basic combat equipment. During training the new member may be expected to buy certain books or subscribe to certain magazines that his work requires. During this time the new member will also be supplied with reading material on the strategy and tactics of guerrilla warfare. This home work will make it possible for him to fit in quickly to an active unit and participate effectively in actual maneuvers, marksmanship training, etc.

Following this preliminary training a member may be either assigned to an existing unit, assisted in organizing his own unit if he has shown sufficient leadership qualities or become part of an underground network.

Upon your acceptance into the Secret Army Organization you will be given a definite series of projects described in writing so you will know exactly what will be expected of you.

We hope that you can succeed in this effort because your country desperately needs patriots at this time.

ALWAYS USE  
ZIP CODE

U.S. POST OFFICE, CA 920  
F.M.  
11 MAR  
1972

LEADS COMPANY  
5105 EL CAJON BLDG.  
SAN DIEGO 15, CALIF.

Mrs. E.M. LISK  
1450 Cleveland  
San Diego, California

FOR PLEASURE & PROFIT



3211 Fifth Avenue  
Post Office Box 3636  
San Diego, California 92103  
March 23, 1972

Mr. James E. Bunker  
Attorney at Law  
814 San Diego Trust & Savings Building  
San Diego, California 92101

Dear Mr. Bunker:

I wish to express my appreciation for your letter of March 22, 1972, enclosing material relating to the Secret Army Organization, which had been received by an acquaintance of yours, Mrs. E. M. Lusk.

If it is believed further information in this matter is necessary, you will be contacted by a Special Agent of this office.

Sincerely yours,

ROBERT W. EVANS  
Special Agent in Charge

1 - Addressee  
① - San Diego (157-2815)

ACG:mt  
(2)

*mt*

157-2815-52  
SEARCHED.....INDEXED.....  
SERIALIZED.....FILED.....

UNITED STATES GOVERNMENT

# Memorandum

TO : SAC, SAN DIEGO (157-2815)

DATE: 3/17/72

FROM : ~~THE~~ SAC, BALTIMORE (157-6675) RUC

SUBJECT: SECRET ARMY ORGANIZATION (SAO)  
EM-SAO  
OO: San Diego

Re San Diego report of SA STEVEN L. CHRISTENSEN dated 1/21/72.

Enclosed for San Diego is one copy of Baltimore report of SA JOHN J. GROGAN titled EM-MINUTEMEN.

Enclosed report should provide sufficient information regarding the Minutemen Organization operated by JESSIE CLAYBURN STEVENS of Brentwood, Maryland. Baltimore has a separate case on JESSIE CLAYBURN STEVENS and it should be noted that STEVENS is carried as ARMED & DANGEROUS.

The most current information supplied by <sup>INFORMANT</sup> in enclosed report indicates that JESSIE STEVENS has continued to lose popularity in the Maryland area. This loss of popularity and support can be attributed to constant accusations that STEVENS is an informant. Statements made by ROBERT DE PUGH concerning STEVENS' character have also considerably weakened his support since the writing of enclosed report.

Contacts with the following sources who are familiar with White Extremist activities in Maryland, and specifically, Minutemen operations conducted by STEVENS, failed to indicate that STEVENS has formed an alliance with SAO. Sources indicate that STEVENS may have formed an alliance but has not made this information generally known:

BALTIMORE

INFORMANT	3/13/72
INFORMANT	2/16/72
INFORMANT	3/13/72

② - San Diego (RM) (Encl. 1)  
1 - Baltimore  
WVD:lmk  
(3) *wac*

*157-2815-51*

SEARCHED	INDEXED
SERIALIZED	FILED
FBI - SAN DIEGO	

*Chandler*



Buy U.S. Savings Bonds Regularly on the Payroll Savings Plan

BA 157-6675

SAC, SAN DIEGO (157-2315)

DATE: 3/17/72

ANNAPOLIS

INFORMANT

2/28/72

Detective CHARLES TENNY of the Baltimore County PD, Intelligence Division, conducts White Extremist investigations in the county. TENNY has advised he is aware of SAO activity on the west coast. He has, in fact, corresponded with this organization. Detective TENNY, after canvassing his White Extremist sources in Baltimore County, corroborated the information that STEVENS has not formed a working alliance with SAO.

On 3/14/72, Baltimore Division received a copy of a Dallas Informant Report. Dallas informant INFORMANT advised on 2/14/72 that a Minuteman supporter named ROY BROWN, from Christoval, Texas, had been in contact with JESSIE STEVENS. In an exchange of letters between BROWN and STEVENS, it was learned that STEVENS is going to travel to Texas and on into Mexico in the last half of March, 1972. Baltimore has no information re specifics of this trip, but San Diego might contact Dallas to see if STEVENS attempts to contact any SAO supporters in Texas.

In view of the above information, Baltimore is no longer conducting any further investigation regarding SAO and the proposed alliance with JESSIE STEVENS' organization. If office of origin determines by west coast investigation that such an alliance exists, Baltimore should be notified and they will reactivate investigation.

that STEVENS has formed an alliance with SAO. Sources indicate that STEVENS may have formed an alliance but has not made this information generally known:

BALTIMORE

- SA [Name] (Info) 3/13/72
- SA [Name] (Info) 3/16/72
- SA [Name] (Info) 3/13/72

(2) - San Diego (Info) (Encl. 1)

1 - Baltimore

(3)

**GENERAL INSURANCE AGENCY**

OF SAN DIEGO

2020 EL CAJON BOULEVARD  
SAN DIEGO, CALIFORNIA 92104

PHONE 297-4754

EDWARD A. FURBUSH

ATT. OF \_\_\_\_\_

TO F. P. T.

SAN DIEGO, Feb. 22, 1972.

RE: \_\_\_\_\_

The enclosed was inserted in the mail slot of our door during the night of Feb. 21, 1972.

Having worked for the F.B.I. myself, I hesitate sending in this type of material but it makes me furious to think someone would pass this type of thing out.

Mildred Furbush

*Mildred Furbush*

*Acknowledged  
Very honorably 2/23/72  
AR*

*Christina  
Per our conversation  
forward copy to  
Bureau  
offer  
AR  
423*

157-2215-49

SEARCHED	INDEXED
SERIALIZED	FILED
FEB 23 1972	
FBI - SAN DIEGO	
<i>[Signature]</i>	
FBI	

# WANTED

for TREASON

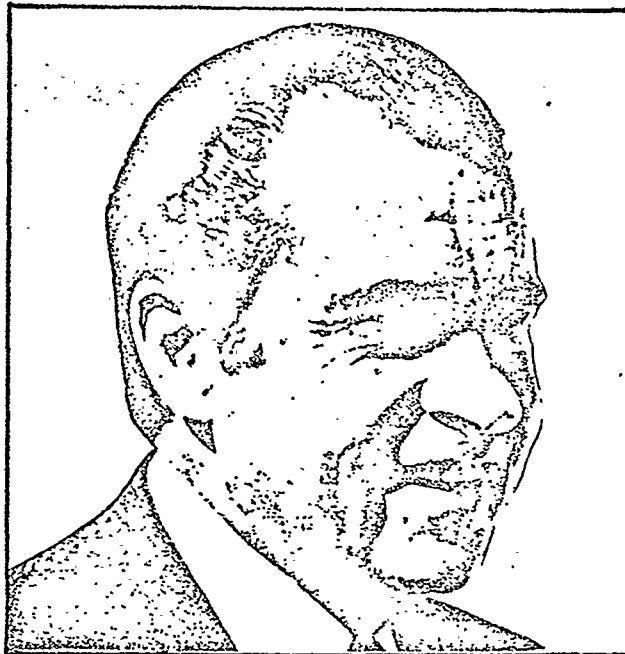

## NIXON

DESCRIPTION

RECEIVED 2 2 18



# NIXON

## DESCRIPTION

FULL NAME: Richard Milhous Nixon. DATE OF BIRTH: January 9, 1913 at Yorba Linda, California. FORMER OCCUPATIONS: Used car salesman, law clerk, second rate congressman, and mediocre Vice President. PRESENT OCCUPATION: Professional liar and double crosser (part time employment as United States President). WEIGHT: 170 pounds. EYES: brown. HAIR: black. HEIGHT: 5' 11". RACE: White. NATIONALITY: Claims American citizenship but actions prove this unlikely. LAST KNOWN ADDRESS: 1600 Pennsylvania Avenue, Washington, D. C. (Rumored to have a California hideout.)

## CRIMINAL RECORD

RICHARD NIXON (alias Cry-Baby Nixon, alicas Tricky Dicky) is an expert in disguises and has successfully passed himself off as an anti-communist in the past. He may again try using this disguise if pressed for votes in 1972. Saying one thing, then doing the opposite is Nixon's MOA. While he campaigned in 1968 on a platform of curtailing socialism he has in fact done more to establish a socialistic dictatorship than either of the last two Democrat administrations. His economic policies have continued to enrich Big Industrialists while rising prices and higher taxes have all but reduced the average worker to a state of financial slavery. This criminal has even made vicious attacks on small children (forced busing to acheive "racial balance") and has caused the destruction of local school systems. WARNING: Nixon suffers from an EMPEROR COMPLEX and becomes extremely dangerous when criticized.

## CAUTION

Trickery and deceit are Nixon's trade-marks. At the present time Nixon and his chief henchman HENRY (CZAR) KISSINGER are engaged in forming an alliance with another gang of criminals, the Red Chinese. The RED CHINA GANG have slaughtered an estimated fifty million of their own people since coming to power. This Godless horde of barbarians killed thousands of Americans in the Korean War (shooting captured soldiers and starving and torturing prisoners of war). The RED CHINA GANG have been supplying the NORTH VIETNAMESE BANDITS with weapons and bullets to kill American soldiers in another no-win war in Vietnam. The very fact that Nixon is dealing with these ARCH ENEMIES OF FREEDOM is enough to convict him of treason. DO NOT LET THIS CRIMINAL STEAL YOUR FREEDOM. DEMAND HIS ARREST BY PROPER AUTHORITIES AND HIS TRIAL FOR THE CRIME OF HIGH TREASON.



Secret Army Orga

106-16200-Sub 4-9P2  
"Calup"  
(2/72 106-16200-Sub 10-2P2)

SEARCHED  INDEXED   
FEB 2 1972  
FBI - SAN DIEGO

# Memorandum

TO : SAC, SAN DIEGO (157-2815) (P)

DATE: 3/9/72

FROM : SA DONALD R. BELMONT

SUBJECT: SECRET ARMY ORGANIZATION (SAO)  
EM

Attached letter re captioned organization was received this date by mail at the Escondido RA from DONNA LEE HARTLEY, 615 N. Melrose Drive, Calif.

No action being recommended, and it is suggested no acknowledgement be made of receipt of letter, since any acknowledgement results in another flood of letters from her.

(1)  
DRB

*Christina* 157-2815-38

SEARCHED _____	INDEXED _____
SERIALIZED _____	FILED _____
MAR 13 1972	
FBI—SAN DIEGO	
<i>DRB</i>	

Buy U.S. Savings Bonds Regularly on the Payroll Savings Plan



CONFIDENTIAL!

Donna Lee Hartley  
615 N. Melrose Drive  
Vista, California 92083

February 29, 1972

Mr. Belmont  
FBI  
659 Escondido Blvd.  
Escondido, California

Dear Mr. Belmont:

Since reading about the FBI files and records being stolen by Radicals, I implore you to either destroy my last letter about the Secret Army Organization or send it back to me, and not to keep it in your regular files, if this is what is done with all correspondence. Also, it's hard to say who will be the next director of the FBI, or whether he, or the people he appoints will be able to be trusted--as J. Edgar Hoover and his men. There will never be a man as good or competent as J. Edgar Hoover. And I fear for the safety of our Country, if and when he retires! (I do not trust Nixon, I don't even respect him, and he is not, what many people used to think he was!)

If the SAO, are truly dedicated Counter-Revolutionary's, then they are your only hope, and mine, and it would seem that every loyal Police Officer and FBI agent in the U.S.A., would have to join in the battle with us, should we be taken over--or Civil War break out. Therefore, it would be in your best interests to either destroy the letter I sent inquiring about the SAO, (after talking to Nancy Byrd, of the Sheriff's Dept. Deputy Byrd) I feel more confident, that they are all I hoped they would be, and also, out to help the Police and to protect them.

Because of Govt' interference I'm sure the SAO wouldn't have wanted me writing to you, not because they don't trust FBI agents or J. Edgar Hoover (I'm sure) but because they know there are Red's high up in the Govt. and they don't trust ANY Attorney General's anymore, for which I don't blame them!! (Any Attorney General who would quit to try to get Nixon elected, has to be very left of center--to put it mildly! Except for J. Edgar Hoover and you FBI agents, and the Conservatives--Washington D.C. is rotten to the core!!!

---

I would never betray the SAO, and I guess I shouldn't have written to you about them, in case the FBI records get into the WRONG HANDS, but I just wanted to find out your professional opinion on them, and also find out, if I actually walked into a Red trap.



March 7, 1972

I sincerely hope you can indeed, have my previous letter in regard to the SAO destroyed. If it ever got into enemy hands, which it surely would if a leftist were to be appointed as director of the FBI, I would be assassinated, and perhaps my children killed too.

Much to my shock the Reds already know about the SAO, (but HOW, I don't know, as they maintain the utmost in secrecy and security.) and if the Communists hate them, (or us) as much as they say they do, they they must be wonderful people!

If the SAO are true patriots, with high principles and standards, and if they have faith in God to deliver us from our brutal deadly enemies, then I would do all I could to help them--within the Law.

The only reason I revealed all this information to you, and to my friends in the San Diego County Sheriff's Dept., is because, as I said to Sgt. Paul Franklin, I know I can trust you, and we are on the same side. I never would have given this information to the Sheriff's Dept, if I didn't know him, and many of his men personally, and in fact I worked on his campaign to elect him Sheriff, as did many a John Birch Society member, who knew for sure he was a loyal American, and a man for LAW AND ORDER, and an Anti-Communist. (By him, I mean Sheriff John Duffy.)

I asked Sgt. Franklin, to keep the SAO material out of the regular files. All we can do is HOPE, that the Sheriff's Dept., and other Law Enforcement agencies aren't infiltrated with Reds!

After much studying and serious reflecting, I can see no hope for America, unless we ALL band together in a highly organized Counter-Attack, in a strong purposeful underground group and fight for our liberty and our lives--or else be reduced to a satellite slave nation.

Who could know the inside story better, than the top military men, who are leading the Counter-Revolutionary's? They were not allowed to win the Korean or Vietnam wars, and had to watch our fine young men die--in vain. (50,000 they tell me, in the Vietnam war, alone, not to mention the Korean fiasco.) The blood from these men--cries out for justice, and for recompense, from the criminals who ordered them to die--for nothing--or for the Viet Cong, or Soviet KGB!

Surely God will grant eventual justice for these men--as well as all the murdered American Policemen, and those of the rest of the free world also. The traitors should not go free.

MAY GOD HELP US--

Very Respectfully,

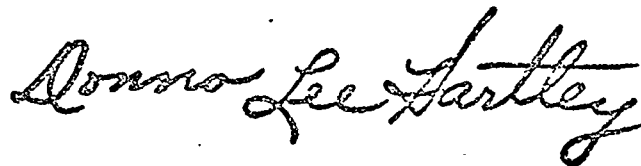
A handwritten signature in cursive script that reads "Donna Lee Hartley". The signature is written in dark ink and is positioned above the typed name.

Donna Lee Hartley

Rec'd 3/9/72  
0887

Organization was  
HO RA from DONNA

and it is suggested  
letter, since any  
of letters from

CONFIDENTIAL!

BX 1779

MR. BELMONT  
FBI  
659 ESCONDIDO BLVD.  
ESCONDIDO, CALIFORNIA

AM  
6 MAR  
1972

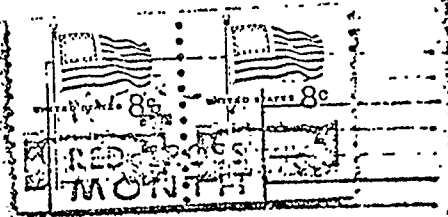

157-2215-  
SEARCHED INDEXED  
SERIALIZED FILED  
MAR 13 1972  
FBI-SAN DIEGO

Payroll Savings Plan.

# Memorandum

TO: SAC, SAN DIEGO (157-2815) (P)

DATE: 3/6/72

FROM: SA DONALD R. BELMONT

SUBJECT: SECRET ARMY ORGANIZATION (SAO)  
IS - SAO

Attached hereto is a letter received at the Escondido RA from DONNA LEE HARTLEY, 615 E. Melrose, Drive, Vista, California, in which she advises she has joined the SAO because of her concern over the Communist threat.

On 3/6/72, Mrs. DONNA HARTLEY was telephonically contacted by SA BELMONT for the purpose of acknowledging her letter. She was informed that the FBI could not furnish her any information concerning the SAO or advise her as to whether she should or should not join this organization. She stated she became interested in the SAO after she read an article in the San Diego Union concerning the shooting incident involving PETE BOHMER, in which "the communists were blaming the shooting on the SAO." She thereafter wrote a letter to SAO and she received some literature on the history of SAO and also received an application for membership in SAO, which she filled out and sent in.

She stated since making application with SAO she has realized that this organization condones violence, which she does not. However, she plans to remain in the organization, for the time being at least, for the sole purpose of obtaining information concerning its activities and furnishing it to the San Diego County Sheriff's Office. She has written to Sgt. PAUL FRANKLYN, Intelligence Unit, SDSO, and a ~~xxxx~~ Deputy NANCY BYRD of the SDSO has come to see her and has indicated she will be contacting her in the future about SAO. She stated the SDSO has indicated they will pay her dues in the SAO.

It should be noted that DONNA LEE HARTLEY is a prolific letter-writer, not only to the Bureau but to the newspapers, particularly the Daily Times-Advocate, Escondido. She is very pro-Bureau and pro-law enforcement. She appears to be obsessed with the idea of becoming an informant; however, it is not recommended that she be utilized as such.

(2)  
DRB

*2 agree  
DRB*

157-2815-370

SEARCHED _____	INDEXED _____
SERIALIZED _____	FILED _____
MAR - 7 1972	
FBI - SAN DIEGO	

*Christensen*

Buy U.S. Savings Bonds Regularly on the Payroll Savings Plan



3/3/72  
0863

una Lee Hartley  
N. Melrose Drive  
sta, California 92083

bruary 25, 1972

**CONFIDENTIAL!**

as to the SECRET ARMY ORGANIZATION,  
in the Law. It is a Counter-Revolutionary  
ed becoming active in it, if they are  
, indêed they ARE on the side of the  
wondering--could they be a Red trap?

electronic surveillance, counter-  
infiltration tactics, etc.  
he side of the Police and FBI I would  
efore sent me an application. (Which  
on the side of the Police and FBI.  
the thought dawned on me, that maybe  
frustrated, how do I know?

It seems so tragic to me, that  
on, because of the permissive  
no death penalty even.  
ing in freedom, the "Pursuit  
ppiness"--supposed to do?  
the seeming inevitable  
sworn to resist a takeover to  
being strangled, in a pincers  
sympathizers at the very top  
es at the bottom--the Revolutionaries!

**SOMEBODY DO SOMETHING!!.**

**AGENTS???? To the POLICE?**

ded American blame those of us, who  
r-Revolutionary Army--since our own  
d infiltrated? The Police can no  
have been rendered helpless and useless  
Supreme court have destroyed America.

FBI  
Mr. Belmont  
659 N. Esccondido Blvd.  
Esccondido, California

BX1779

U.S. PC  
26 FEB  
1972

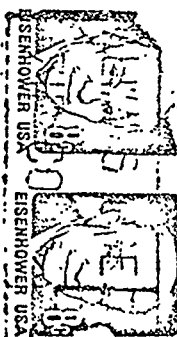

I don't intend to break any laws--but some laws were made by Communist  
Sympathizers. Those of us who have the Spirit of 76 in us, simply  
cannot sit back and passively wait to be engulfed in the most hideous  
tyranny and slavery and evil, that the world has ever known.

**DO YOU BLAME US?**

Donna Lee Hartley  
615 N. Melrose Drive  
Vista, California 92083

February 25, 1972

FBI  
Mr. Belmont  
Escondido, California

Dear Honorable Sir:

I am seeking your expert advice, as to the SECRET ARMY ORGANIZATION, and to whether or not it is within the Law. It is a Counter-Revolutionary militant group. I have considered becoming active in it, if they are truly what they claim to be. If, indeed they ARE on the side of the Police, and the F.B.I. Or, I am wondering--could they be a Red trap?

They have sent me literature on electronic surveillance, counter-revolutionary combat training, infiltration tactics, etc. I told them, if they "were on the side of the Police and FBI I would be glad to join them, they therefore sent me an application. (Which at once verified that they were on the side of the Police and FBI. After I sent the application in, the thought dawned on me, that maybe it's a trap. Maybe they are infiltrated, how do I know?

Mr. Belmont, we at war with Communism. It seems so tragic to me, that we no longer have any Federal protection, because of the permissive courts, and traitorous judges, and now, no death penalty even. What are those of us, who insist on living in freedom, the "Pursuit of Life, Liberty, and the Pursuit of Happiness"--supposed to do? Are we supposed to sit back and wait for the seeming inevitable death warrant for those of us who have sworn to resist a takeover to our last breath? We, the people, are being strangled, in a pincers strategy--the big Communists and their sympathizers at the very top of our Government, and the little ones at the bottom--the Revolutionaries

In the name of Heaven, why doesn't SOMEBODY DO SOMETHING!!.

WHAT IS GOING TO HAPPEN TO YOU FBI AGENTS???? To the POLICE?

Really now, can any true red-blooded American blame those of us, who want to join an effective Counter-Revolutionary Army--since our own armed forces are so mutinous and infiltrated? The Police can no longer protect us, because they have been rendered helpless and useless by the courts. The Reds in the Supreme court have destroyed America.

I don't intend to break any laws--but some laws were made by Communist Sympathizers. Those of us who have the Spirit of 76 in us, simply cannot sit back and passively wait to be engulfed in the most hideous tyranny and slavery and evil, that the world has ever known.

DO YOU BLAME US?

In my profound grief and heartache, and frustration over our National situation, I have joined this Pro-American militant group.

The SECRET ARMY ORGANIZATION.

But, I repeat--are they really Pro-American, or have I walked into a TRAP? The Communists have succeeded in causing unprecedented SUSPICION and FEAR, in our once great and glorious Nation. Now we are reduced to suspicious and wary warring factions--a CIVIL WAR!

As I have said before--I would rather that we (my children and I) die, than to live under Communism. (The next world, with God, will be better than this one anyway!)

If Red China is going to take us over (and it looks like soon) then I'd rather work in an underground Resistance movement--and die like a true American with Red blood in my veins, instead of a yellow stripe down my back. (Though I'm not saying I'm not scared--or maybe even paranoid--by now!)

I never thought such a disgusting thing would happen to our beloved America. Truly, it looks like the days of the Vigilantes--has been forced upon us--(probably deliberately!)

Many people I know, are confused, terror stricken, and "their hearts failing them for fear."

In my present economic situation I suppose I have no right to complain about "big Government", but--the rights of the people, the freedom's and the liberty are slipping away from us. Should we let it all go down the drain--without a fight to the death? Conservatives who are patriotic and love America have been silenced and even persecuted for their beliefs.

(I realize you know all this.)

Religion, God, and the Bible is now being attacked, as is the sanctity of the home.

I joined this group(S.A.O.) in the belief, that they are Pro-American, Pro-Police, and Pro-FBI.

May I please hear from you (I also wrote to Sgt. Paul Franklin, of Vice & Intelligence.) as since doing some reflecting and pondering over the literature they sent me, I am wondering if I did the right thing, or if I did walk into a TRAP.

It is my profound desire not do anything that would be frowned upon by the true American FBI or truly dedicated Police. (I'm sure MOST of them can be trusted--but I am now beginning to wonder if the SAO believes this.)

Nothing nor nobody, will ever diminish my great respect and gratefulness for the FBI. If the SAO does not feel this way about the FBI, then there has to be something wrong with them, and in that case, I want nothing to do with them, and will tell them so. (In which case, I may find myself being aimed at from two directions.

They may be okay, but I desperately, need your advice and opinion, in this matter. I don't want to do anything illegal, and I want to help my Country, not hurt it, in any way. Frankly, I'm not sure what I've gotten myself into--the intrigue and suspense is unbearable.

In yesterdays secret mailing of literature to me, I was told I will be sent training instructions in two weeks. (Counter-Revolutionary Guerrilla Warfare, actual Combat, and underground resistance tactics. Most of the literature yesterday was on electronic surveillance, and the various weapons needed, plus other equipment needed. Plus the stickers shown below.)

**FIGHT COMMUNISM**

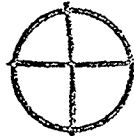

join the

**SECRET ARMY  
ORGANIZATION**

write

SAO Box 5791, San Diego, Calif. 92105

It seems logical, that if our Government is taken over completely by the Red's--then you FBI agents, plus the loyal Police and all true American Law Enforcement people, will be forced to join something like this. Right? I don't see what choice you will have. Otherwise they will kill all of you. Please don't let that happen.

No matter what our status in life, or economic bracket, everyone of us, will have to pull together, unite and put everything we have into this fight for survival. The lines have already been drawn--there is no middle road! With the Pro-Communist feeling now being fostered by certain traitors in our Govt. and ALL the main news media--what choice we have--but to join an organization that trains us to fight the enemy, with the resolve to overthrow him. The true Americans will be HATED with a Satanic passion--because of this massive brainwashing of the general public going on right now. This masochistic mania to embrace bloody Red China--is the ultimate of insanity and criminality!!!! It seems like an unreal, hellish nightmare to so many of us.

If the SAO is really what they say they are--and are not frowned upon by the Police--then I will give them every ounce of my energy and devotion and dedication.

If I don't hear from you, I will take it to mean that they are okay.

(You people are so busy, this letter probably won't get read, but at least I got it off my chest.)

LET ME REPEAT: I WOULD NEVER DO ANYTHING THAT THE FBI OR J. EDGAR HOOVE DIDN'T SANCTION.



But--if the leftists in the Govt. put a Communist at the head of the FBI--that of course, would be an entirely differant story.

Well--please forgive this long letter. But this whole Satanic mess, makes many of us fear for our sanity--(which is what the Red's want--to break our will to win!!)

All I know, is that I will die fighting rather than meekly and passively submit to the most brutal tyrants the world has ever known.

(If I'm wrong in joining the SAC--I IMPLORE YOU TO LET ME KNOW, you, or the Sheriff's Dept., would be the only ones who could tell me what I've gotten myself into.)

If they ask me to break any laws--I'm afraid I will have to say no--then who's to say--they wouldn't have me marked as a traitor?

They, (the SAO) call themselves the "last line of defense against Communism." I thought it sounded good--since our Government is not allowed to protect us anymore--nor is the Police. All I'm trying to do is defend my family--myself, and all good loyal American's, including you of the FBI., in my small humble way.

Right now--I am under surveillance by the SAO, as they said I would be, for security reasons, if I joined. (Maybe I am also under surveillance by the Communists. Some mysterious guy, with sun glasses and sneaky look, has walked by here real slow periodically, with a scrutiny that is unmistakable, for months now!)

They may be perfectly okay, and my imagination and suspicion may well be working overtime. But I'm somewhat confused by this literature they sent me yesterday.

The way I see it, as I said, it's now impossible for anyone to walk a middle road, for those of us who want to make sure that "Freedom does not perish from the earth."--and indeed survive, but, alas, I'm repeating myself! What I am trying to say, in my round about way, (or explain) is my reason for going so far as to join this militant Counter-Revolution group. (I don't understand why Americans by the thousands--arn't doing the same thing!!!!)

If the Red's take over, I don't want to live anyway--so what have I got to lose????

GOD BLESS YOU,  
WITH MUCH RESPECT AND GRATITUDE!

*Donna Lee Hartley*  
Donna Lee Hartley

P.S.

Please let me know if I'm wrong by joining the SAO. ARE THEY ON YOUR SIDE????

(Later) Please excuse the grammatical errors -- I was upset & not  
with my mind to type

this letter. (If indeed, I remain with the SAO - I will undergo strict discipline training - & will no doubt have to learn to cool my passionate emotions - [for the good of the Country] But - how can one not show high emotion & passion - when one loves, so much their glorious Native Land - and sees it being defiled, desecrated, & destroyed??!!

GOD HAVE MERCY ON AMERICA, & SAVE US

It certainly, in my estimation, takes passion & emotion to willingly offer ones life - endeavoring to WIN a war.

Whether or not - I become actually actively involved in SAO - depends on some kind of answer either by you - or Sgt. Franklin [Vice + Intelligence - Sheriff's Dept.] (Came to this conclusion - after receiving this last packet of literature)

SAC, SAN DIEGO (4-00)

2/18/72

SUPERVISOR ANTHONY J. MALONEY, JR.

FIREARMS ACTS

Special Agents handling extremist matters should be particularly alert to reacquainting themselves with all of the criminal statutes involving gun law violations so as to be in a position to recognize and pursue such possible violations when they come to your attention during extremist matter investigations.

The review should include Bulets to Albany (all offices) dated 3/18/71 and 5/17/71 captioned "Firearms Acts" (located in 4-00-Serials 29 and 31), as well as Manual of Instructions, Volume III, Section 74, and the FBI Handbook, Part III, Section 55.

1 - 4-00  
① - 157-2815  
1 - 157-2928  
1 - 157-00

AJM:mt  
(4)

157-2815-25

SEARCHED	INDEXED
SERIALIZED	FILED
FBI - SAN DIEGO	

*Christman* *ME*

1294X  
1294X

9  
X encls.  
80

9-5-78  
12/17/78

The Attorney General

SSC

Special Agent

Ref made to 1/20/78 SSC let [unclear] DOJ by  
let dtd 1/21/78, containing [unclear] for [unclear]  
Enc for ur approval & forwarding to Comm-ori of  
same which is responsive to some of the req. Copy  
of memo beg furn for ur records along w/set of  
materials to which SSC access is to be considered  
by DOJ.

Documents enclosed.

SSC Request 1/20/76  
Item 2 (Re: Howard Berry Godfrey)  
Volume III

Access





Listed below is information which was allegedly obtained by the Minutemen Organization from the files of the underground newspaper known as the "San Diego Free Door to Liberation".

Names and Addresses from a small telephone number and address directory:

APCOPrinting, Inc.  
2141 Bixby Road  
Lakewood, California 90712  
Telephone 213-426-7123

ROBERT J. BERTON  
1355 Front Street  
Suite 200  
San Diego, California 92101  
Telephone 239-3331

BOLAND, BERNIE And GAY  
790 North Yucca  
Rialto, California 92376  
Telephone 714-TR5-3447

Mrs. J. G. BINGHAM  
25615 Norbonne Avenue  
Apartment Number 10  
Lomita, California 90717  
Telephone 213-326-8017

BEVERLY EDWARDS (March 28, 1969)  
Lakeside  
Telephone 443-3496

DEAN MITTEN  
398 4th Street  
S.B.  
telephone 885-1514  
320 Laurel (JERRY SIRSEN)  
San Diego  
Telephone 234-3161

BALDIVA DAVILA  
995 Broadway  
El Cajon  
Telephone 442-4066

*Jerome*

BETTY and JOE DOWNS  
4929 North Wolcott-3A  
Chicago, Illinois, 60640

Fast Print Company (Close Saturday)  
5520 University  
Telephone 583-9591

LON GUILD  
5192 La Dorna  
San Diego 92115  
Telephone 583-2511

Mrs. L. C. HERSCHLER  
445 Argyle Drive  
Alexandria, Virginia 22305  
telephone 703-548-9673

SARA HERSCHLER  
1862 Woodland Avenue  
Columbus, Ohio 43219  
Telephone 614-253-5751

HILDA  
Telephone 443-2072

LOUIS HERSCHLER  
94-923 Makaloha Street  
Waitahu, Hawaii 96797

CAROL HERSCHLER  
236 Porter Hall  
Miami University  
Oxford, Ohio 45056  
Telephone 513-529-7197

JIM HAYDEN  
3760 Adams Avenue  
San Diego 92116  
Telephone 222-8609

SAMUEL HECSH  
Residence telephone 224-8297  
Business Telephone 234-3441

J

2



Private MAX HERSCHLER  
RA 11708980  
CMRX5  
Box 18079  
Ft. Rucker, Alabama 36360  
3990 South Hwy,  
85-87 Lot 40  
Colorado Springs, Colorado 80909  
Telephone 303-392-5036

SUEY JAY (BILL JAY)  
3137 National Avenue  
Number 10  
San Diego 92113  
Telephone 235-0142

JUDY (typist)  
4432 Campus

VIRGINIA BRIGGES  
S.P. Valley  
Telephone 469-0357

MIKE MILLIGAN  
Telephone 460-2515

BENTE MEYERS  
P.O. Box 1676  
Vista  
Telephone 724-5703

YVONNE MITSINGAS  
1949 31st  
Telephone 233-0725

ELEANOR MARTIN  
1028 Redwood Avenue  
Apartment 28  
El Cajon, California 92021  
Telephone 442-5092

PENNY BATES  
Telephone 448-7189

AL RICKEL  
1056 Grand Avenue  
P.B.  
Telephone 488-1879

PWJC-IRVIN FALK  
1145 4th Avenue  
92101  
Telephone 232-4311

Pacific Distributors  
232-3284

Paine, Mable, Jackson  
and Curtis  
1145 4th Avenue  
San Diego 92101  
Telephone 232-4311

Forward; LYNN RANICO  
CAROLYN RANY  
8007 Eastern Drive  
Number 302  
Silver Springs, Maryland

LAMBERT Optical Company  
143 North High  
Columbus 15, Ohio

LOIS O'NEAL  
(worker for THATCHER)  
North on 69th from University (South)  
2nd house on right past Donn Way  
Telephone 286-8297

LUCY EDWARDS  
2776 54th right on Nutmeg, kind of u-turn,  
right again to dirt road to left,  
house sets back  
Telephone 263-3831

ABBIE  
Telephone 442-6658

ELEANOR MARTIN  
8288 Orchard Avenue  
Apartment G  
La Mesa, California  
Telephone 465-7470  
4940 Comanche  
Apartment Number 1

WILLIAM RICHARDSON, Landlord  
3630 Fir  
San Diego 92104  
Telephone 234-1492

Mrs. BONITA RAMSEY  
3349 43rd  
San Diego  
Telephone 281-0527

RHODA RISDELL  
637 Forward Street  
459-7995

JEN T. TRADER (Nut)  
(Met at Nexus Open House)  
6869 Park Ridge Boulevard  
San Diego  
Telephone 465-5243

STEPHANY SALKELA  
(Museum of Man)  
304 West Ivy  
Apartment 204  
LaMonda Apartments  
Telephone 232-2554

THERESA THOMPSON  
5715 Androse Place  
Apartment Number 4  
San Diego  
Telephone 286-4819

SYNANON (new)  
3955 Fourth Avenue  
San Diego 92103  
Telephone 297-1171

Teaspoon  
3493 University  
92104  
Telephone 282-8431

JOCELYN THOMAS  
(Lady at Nexus)  
5015 Cliff Place  
Telephone 283-1452

GARY THATCHER  
Telephone 442-6668

VPI (Closed Saturday)  
2113 El Cajon Boulevard  
Telephone 297-4223

Vanderpool  
P.O. Box 531  
Del Mar  
Telephone 755-3845  
Telephone 755-3111

The following names and addresses and other information were contained in a mechanical telephone number and address directory:

Abortion Counseling Service  
1369 B Street  
92101  
233-4515

Academy Theater  
284-1000

A.B.L.E.  
520 E Street  
Room 502  
San Diego  
234-3158  
232-6621

AA  
239-1365

ACLU  
Post Office Box 6233  
San Diego 92106  
223-3863

APCO Publishing Corporation  
2141 Bixby Road  
Lakewood, California 90712  
Attention: WILLIAM B. ANDREWS  
426-7123

Arlington Times (Riverside County Publishing Company)  
1094 Hale Avenue  
Riverside, California  
689-1122  
(PETE PARSONS)

ROBERT JAMES BERTON  
1355 Front Street  
Suite 200  
San Diego 92101  
Business phone: 239-3331  
Residence phone: 463-6380

Boland.  
790 Yucca  
Rialto, California 92376  
875-3447

Crisis  
3004 Imperial  
239-0325

Citizens Interracial Committee  
5th floor of the Robinson Building  
5th and E  
239-0871

The Candy Company  
7711 El Cajon Boulevard  
469-9376

Coast Dispatch at Encinitas  
(JIM BARROTT)  
459-1213  
459-6543

GARY WAYNE CRANE  
3965 Paula Street  
La Mesa, California  
460-6924  
465-9891

Cosmic Center - Greig  
488-5551

Butch Cornelius  
2727 De Anza Road  
San Diego 92109  
274-0670

LON CURTIS  
291-1786

JEANETTE DUFTON  
Dean's Photo  
Lemon Grove  
239-5450  
459-3707  
460-7675

DARE (BRUCE)  
2968 Nutmeg  
232-1159  
283-5186

DEAN WITTER  
JERRY SIRSEN  
320 Laurel  
San Diego  
234-3161

YVONNE DA TORRE  
3536 Fairmount  
282-4777

Draft Counseling  
J. STUART INNERST  
5840 Camino De La Costa  
La Jolla 92037  
459-3174

Draft  
FRED GORDON  
755-4654

San Diego Draft College  
DEBBIE  
276-8866

ELLIE  
465-7470

DENNIS EWALD  
4675 $\frac{1}{2}$  Voltaire  
222-6196  
home: 1858 Chatsworth  
224-4633

IRWIN FALK  
1145 4th Avenue  
232-4311

Fast Print  
5520 University  
583-9591

Folk Arts  
291-1786

SAMUEL HECSH  
234-3441  
224-8297

JIM HAYDEN  
4560 Wilson  
San Diego 92116  
284-5565

HERB JOSEPH  
4904 Clairemont  
273-8772

SUEY JAY (BILL JAY)  
3137 National Avenue #10  
San Diego 92113  
235-0142

KPRI  
645 Ash Street  
San Diego, California 92101  
239-1385

~~Kairos~~  
624 Upas  
295-1569

~~M. LEVENS~~  
4258 Middlesex Drive  
San Diego 16

~~ETTA LINTON~~  
264-5134

PATTIE LYONS  
7447 Cayhill Drive  
San Diego  
262-2562

STEVE MONTIJO  
469-7631

BERNARD MARCUS  
291-2363

Message Information Center  
232-6621



YVONNE MITSINGAS  
1649 West Clinton Avenue  
Fresno 93705

CLEM MARKS  
239-2941

MIKE MILLIGAN  
583-3251

ELEANORE MARTIN  
460-0596

WILLIAM MAGUIRE  
9523 Abbeywood  
Santee  
448-0675

Reverend RICHARD MCKENNA  
1924 Island  
232-6621

MIKE MC HUGH  
9247 Carlton Circle  
Spring Valley, California 92077  
466-3149

WALTER MC CLURE  
5002 Santa Fe  
272-3170

New Adult Community  
232-6621

Nexus  
340 South 3rd  
El Cajon 92021

AM Generation  
Lakeside  
443-3519

Plebian  
La Jolla  
454-1888

Paisley Pelican  
Newport Avenue  
223-6901

Planned Parenthood Association  
House of Hospitality  
B.P. 234-7593

Peace and Freedom contact  
ALTA BERTRAM  
465-2838

PAGNI  
3605 30th Street  
291-3020

AE RICKEL  
1056 Grand Avenue  
488-1879

Pacific Distribution  
Mr. LEVISH  
621 4th  
San Diego  
232-3284

RICK PHELPS  
1844 Washington Place  
232-1743  
466-6061

Riverside Co. Fbl. Co.  
Post Office Box 8368  
OV9-1122

WILLIAM RICHARDSON  
3630 Fir  
San Diego 92104  
234-1492

BOB RINEHART  
443-1539

HARRY RIDER  
460-9423

Revolution  
JOAN JENSEN  
1787 Titus Street  
San Diego 92110  
296-4625

DICK RUSSELL  
459-4439  
454-7658

STOVOLD  
753-8709

Experimental College  
286-6575

Stock Quotation  
239-6181

STAN SOHLER  
35061 Beach Road  
Capistrano Beach, California 92624

SFL  
Post Office Box 0105  
College Grove Center  
San Diego 92115

RAY SCHWARTZ  
4382 Roselind  
La Mesa  
465-6544

GENE SPARKMAN  
488-4077

Street Journal  
3605 5th Avenue  
233-4454

T M  
1806 Erie  
276-2217

GARY THATCHER  
411 South Magnolia  
El Cajon 92022  
442-6668

The Indicator  
UCSD  
453-1077

VOY (RONNIE WEINS)  
235-8945

Vanderpool  
Karmacy  
3825 5th Avenue  
291-1798

~~ROBERT WORMAN~~  
D.W. 398 West 4th Street  
S.B. 92041  
889-0741  
885-1515

HOWARD WRAY  
~~460-4400~~

~~STEVE ZARK~~  
4288 Harlinson  
La Mesa 92041  
461-1185

Youth Lifeline  
233-1333

/ The following names, addresses, and other information contained in a small cardboard file box with headings as used in the filing system:

People

MIKE MC HUGH  
nudist (knows RINEHARTs)  
9247 Carthay Circle  
Spring Valley 92077  
466-3149

JERRY A. HEATH

6484 Thornywood

San Diego

278-1602

(interested in putting out own magazine to express self. Can pay writer or (?) to help him. Said he would help us in any way he can. Would deliver paste up to Los Angeles.)

PETER DEEMER

Publicity Representative from Kairos

Rancho Santa Fe

Wishing Well Hotel

756-1123

DICK TARQUINIO

7250 Artillery

San Diego 92111

(Journalism instructor at Mesa College)

JOHNNIE and MARIE

Poway

1-748-3368

TOM HEPP

Grossmont College Librarian

(likes people, has worked with Synanon)

8800 Grossmont College Drive

El Cajon

H. VANDERPOOL

Underground Publications

Post Office Box 531

Del Mar, California

755-3845

JAMES PAGNI

291-3020

(puts on dances at the Concourse)

DICK MC KENNA

239-5766

239-2119

JOHN WATANABE

President, SDS

283-0994

JACK FORREY,  
274-4677

GLOVER DAVIS  
SDS, teacher, poet  
residence: 447-0024

Outlets

BARON ROLAND  
Peace of Creation  
209 West Indian School Road  
Scottsdale, Arizona

Head 'n Soul  
4040 Mission Boulevard

BEVERLY GEARHART  
2219 East 1st Street  
N. C.

Jim's Books  
508 Mission  
Oceanside, California 92054  
722-5662

Surfboard Hugo  
3076 Carlsbad Boulevard  
Carlsbad

Larry's (?) Liquor  
(on Grant between Broadway and Escondido Boulevard)  
Escondido, California

JIM MURPHY  
SDS  
UCSD  
755-1900

Mr. MARE  
UCSD Book Store  
La Jolla 92037

Printers

BILL MC CUTCHEON Printers

Encinitas

753-6543

459-4158

Trade Printing Company

3122 Reynard Way

San Diego

AAA Printers

Second Street

San Bernardino, California

LV8-0708

BOB BONAJO

Organizations

Planned Parenthood

295-2223

Council for Social Action

San Diego

Peace and Freedom Party

5728 El Cajon

583-8943

Citizens Interracial Committee

239-0871

Message Information Center at Episcopal Community Services

555 19th Street

Catholic Cardijn Center

Mexican-American Youth Association

Tuesday the Ninth Committee

UCSD

Underground Press

The Teaspoon  
4465 Arizona Street  
San Diego 92116  
298-2195;  
3493 University  
282-8431

JERRY SHEATH  
(to publish San Diego underground, new)

KEN COWAN  
494-5286  
(Laguna)

823-5548  
(UC Irvine)

836-6689  
(Peace Center)

Fluxus West  
KEN FRIEDMAN  
1600 Holloway Avenue  
San Francisco 94132  
(do not give out San Francisco address);  
6361 Elmhurst Drive  
San Diego 92120

Middle Eye  
3550 Duffy  
Muscoy (also north side of King Street,  
west of Mt. Vernon)

The Underground Press

MIKE MILLIGAN, Managing Editor.

Editorial Board:

MARLIN AYOTTE

DOUG KITT

SCOTT JOHNSON

General Coordinator:

ELAIN AYOTTE

Distribution:

KENNY LEVENSON

DON TRAXLER

Photo Work:

Hidrotic Productions.



Staff

CHRIS ENGLISH - SDS  
1144 Marline  
El Cajon  
444-0836

SYLVIA SHAPIRO  
CSA  
Gadfly  
6953 Eldridge  
San Diego 92120  
583-1626

GAYLE INGLORIAN M.  
427-3969

SUNNY ENDONIA D.  
422-6221

ROGER STOVOLD, Photographer  
1420 Neptune  
Leucadia 92024

BOB GAINES, SDS  
4673 Wilson Avenue  
San Diego 92116  
283-9435  
(interested in reporting, interviewing, etc.)

LOU CURTIS  
Folk Arts  
Krome Kazoo  
3753 India Street  
San Diego 92103

MIKE SCHEEL  
4466 49th Street  
San Diego  
(art and write-up on local rock groups)

PATRICIA TVEDT, typist  
465-7470

JILL ZARNOWITZ  
276-2782

SHIRLEY WESTON  
276-4320

BETTY BUCK  
~~273-4335~~

LOUISE OFFINGER  
~~277-6446~~

SUE RADCLIFFE  
~~298-3433~~

STEVE MITCHELL  
~~453-4732~~

DON TONGUEWIEL  
~~(art) 296-3848~~

PEGGY WILSON  
~~283-0994~~

JEANETTE DUTTON  
1330 31st  
239-5450

DARLENE FUJINA  
~~CURT BOUTERSE (really fine lettering)~~  
298-8641

DONNA DAVIS  
706 Nantasket Court  
488-0806

JO ELLEN (DOUG TUTHILL's friend)

BECKY GALDEANO  
(does the hippidrome posters)

DAN LONGUEUEIL  
1737 Fort Stockton  
296-3448

GEORGE ELGIN  
photographer  
3802 58th Street  
San Diego 92115  
286-9257

ELEANOR MARTIN  
8288 Orchard  
La Mesa 92041  
465-7470  
(not good for anything, but love)

TOM HEEKIN  
5951 Eldergardens  
San Diego 92120  
583-9372  
(reporting, writing, record review)

SIDNEY ELLIOTT (SDS art work)  
9265 Virginian Lane  
La Mesa  
465-1778

BLAIR ALLEN  
5056 Woodyard  
La Mesa  
466-1730

STEVE ZARK  
4288 Harbinson  
La Mesa 92041  
463-1920

BUD SONKA  
5061 63rd  
582-6534  
(reporter, etc., or whatever)

STEVEN HICKS  
4724 Austin Drive  
San Diego 92115  
582-0133  
(to write Army experience)

MARV HUMPHREY  
1435 B Street  
San Diego  
233-3705

RICHARD GONSALVES  
1938 Erie Street  
San Diego 92110  
(attends City College - journalism)

STEVE FERREIRA  
50 Monte Vista, Apartment F-6  
Chula Vista, California  
426-0473

VAHN SHAMOTH  
262-9674  
(Foreign journalist, experienced)

JIM SCHEETZ  
(journalism graduate, editorials on local scenes)

STAN OLIVER  
761 Sawtelle Street  
San Diego, California  
465-8784

MIKAEL STEEGER

JIM BAUMANN  
2043 1/2 Grand Avenue  
Pacific Beach 92109  
274-8289  
(interested in writing, history editor)

LEONARD DAVID  
5048 Mt. Frissell Drive  
San Diego, California 92117  
278-0427  
(Social Science major - some photography)

GLORIA TIERNEY  
525 8th Street  
Coronado, California 92118  
1-435-3531  
(attends Southwestern College)

LEE KELLISON (RAYMOND SCOTT)

MIKE LAHEY, SDS  
6222 Madeline, Apt, 192  
San Diego  
286-4746  
(art and writing)

JANA MENESEE

8461 Hudson Drive  
San Diego, California 92119  
469-5481  
(ads, selling)

JERRY MURRAY

4262 Cleveland Avenue  
San Diego 92103  
295-0480  
(writing)

AL PICKEL

1056 Grand Avenue  
Pacific Beach  
488-1879  
(interested in circulation)

RAY HALLER

4534 30th Street  
(art, also illustrations to order)

DIANE REED

223-6482  
(calendar)

BOB RINEHART

9906 River Street  
Lakeside, California 92040  
443-1539  
(cartoonist)

EVELINA PONCE

5376 Penny Place  
San Diego, California 92115  
286-2465  
(writing, music review)

ROBERT E. STRAIN

8058 University Place  
La Mesa, California 92041  
463-4065

JOE FERRARESE

3742 7th Avenue  
San Diego, California 92103  
296-1250  
(writing, theater review)

PAUL J. ROSS  
2608 Shelter Island Drive  
#1 Beggar's Row

STEVE GIFFORD  
(rock review)

JOE CARUSO  
1010 16th Street  
San Diego  
298-4051

STEPHEN W. CAREY, IV  
c/o Pacific Air Lines  
1805 West Fifth Street  
Oxnard, California 93030  
(Haight-Ashbury contact)

LEA BRAMER  
San Carlos  
469-9149  
(writing, copywriting, reporting)

HARRY RYMER, JR.  
4735 Newport Avenue  
Ocean Beach 92107  
(illustrate stores, etc.)

HAL B. OGUSS  
6029 Adams Avenue  
582-6999

GREG MASON  
6141 Dalhart  
La Mesa 92041  
469-6333  
(artist and carrier)

VAUGHN LOUTHEN  
7033 Boulevard Drive, #2  
La Mesa  
460-5640  
(art work)

ALLISON ALLFREY  
San Diego 92103  
297-0155  
(photography, "opinion type" reporting)

ERIC BAECHT  
582-7916  
(movie review)

MARY PRIGMORE  
3104 Freeman Street  
Point Loma, San Diego, 92106  
222-3492  
(reporting, record review)

JIM HAYDEN  
Ocean Beach  
3670 Adams Avenue  
San Diego 92116  
284-5565  
(photography)

JAMIE  
(artist, ads, etc.)

MICHAEL THOMPSON  
4122 Nabal Drive  
La Mesa, California  
469-3985  
(photographer)

DONALD KAY  
2125 Reed Avenue  
San Diego (Pacific Beach)  
235-2322  
(artist - psychedelic)

MARCOS FRYE  
1846 Island Avenue  
#31  
232-9652  
(writing, reporter)

DWIGHT SMITH  
1676 Vann Court  
El Cajon  
442-5427  
(circulation)

JON WOKULUK  
5525 Hardy Avenue  
San Diego 92115  
286-3187  
(artist, cartoonist)

ROY SHORT  
Box 3785  
San Diego 92103  
296-1709  
(writes legal column)

MARK ROEDER  
4888 Jessie  
La Mesa  
(art work, circulation)

STEBANI HORTON  
"Iron Horsemen"  
3838 49th Street  
San Diego 92105

BUTCH CORNELIUS  
912 Beryl Street  
San Diego, California 92109  
(cartoonist)

BRIAN D. SMITH  
3377 Central  
Spring Valley  
460-9998

RICH PHELPS  
1844 Washington Place  
San Diego 92103  
232-1743  
466-6061  
(advertising)



JIM BAUMANN  
2043 1/2 Grand  
Pacific Beach  
274-8289

JAN ECKLER  
8452 Mt. Vernon  
Lemon Grove  
466-3409  
(SDS art major)

MANUEL MARTINEZ  
4915 Jumbo  
San Diego  
(reporting, Mesa College)

MICHAEL FLANIGAN  
2608 Shelter Island Drive

HORST GATZ  
1043 Loring Street  
San Diego  
(SDS senior)  
(writes humorous, satirical, political column)

DREW ALTSTATT  
1372 Opal  
Pacific Beach  
1-488-3570

JACK GARVER  
3641 Birdie Drive  
La Mesa  
469-1732  
(story on Judge Crawford and haircut)

DAVE FLANAGAN  
(reporter)

STEVE MONTIJO  
8539 Chevy Chase  
La Mesa  
469-7631  
291-3160

SUE WILSON  
2102 Balboa  
Apartment #1  
Jahoda (landlady) 273-3340

Paid Subscribers

Hollygate Ranch  
8835 Harbison Canyon  
El Cajon, California 92021

SUSAN HOLMES  
311 Sawtelle Avenue  
San Diego, California 92114

FRED HORN  
4330 Witherby Street  
San Diego, California 92103

GUY IRWIN  
4320 Yale  
San Diego, California

KEM IRWIN  
4938 Bogart  
Baldwin Park, California 91706

E. P. JAFFARIAN  
Route 3, Box 600  
Escondido, California 92025

JIM and JOAN  
PO Box 575  
San Diego, California 92112

E. J. JOHNSON  
PO Box 10521  
San Diego, California 92110

KIRBY JOHNSON  
1319 Missouri Street  
San Diego, California 92109

RICHARD JOKO  
1781 South Valentine Way  
Denver, Colorado 80228

JON JORGESON  
PO Box 10079  
San Diego, California 92110

BILL JUSTICE  
6945 Saranac Street  
San Diego, California 92115

BARBARA KAHN  
3710 Yosemite  
San Diego, California 92109

Dr. ROBERT G. KAPLAN  
104 Quince Street  
San Diego, California 92103

CHARLES KASSLER  
4916 Del Mar Avenue  
San Diego, California 92107

LOUIS S. KATZ  
c/o Gostin & Katz  
1540 6th Avenue  
San Diego, California 92101

F. A. KASTELIC  
7787 Jamacha  
San Diego, California 92114

ARNOLD KAUFMAN  
1809 Linwood Street  
San Diego, California 92110

DALE KIRKENDALL  
Route 3, Box 552E  
Escondido, California 92025

MIKE KIRKHORN  
Milwaukee Journal  
333 West State Street  
Milwaukee, Wisconsin 53201

BRUCE KIRWAN  
3762 $\frac{1}{2}$  Villa Terrace  
San Diego, California 92104

KARL C. KOHL  
6641 Kelly  
San Diego, California 92111

JOSEPH W. KRAATZ  
PO Box 1286  
Vista, California 92083

MIKE JUTTNAUER  
6536 Cascade Street  
San Diego, California 92122

JOSEPH KWOCK  
2506 Puana Place  
Honolulu, Hawaii 96822

JUNE LA FLEUR  
1214 South 14th Street  
Escanaba, Michigan 49829

JACK LAMONICA  
PO Box 165  
Santee, California 92071

J. W. LEASURE  
1112 Bush Street  
San Diego, California 92103

CLINTON LE JEUNE  
5010 Niagara  
San Diego, California 92107

CHRISSY LESIK  
3963 Alicia Drive  
San Diego, California 92107

JUDY LEVENTHAL  
1455 North Los Ruges  
Pasadena, California 91104

Library, Serials  
Wisconsin State University  
River Falls, Wisconsin 54022

BRITTA LIEN  
2315 Presidio  
San Diego, California 92103

PAUL H. LINDBERG  
4734 Hamilton Street  
San Diego, California 92116

RUSS LINTON  
~~2524~~ 44th Street  
San Diego, California 92105

The Local Swinger  
4186 Elm Avenue  
Suite 2  
Long Beach, California 90807

JENNY LONERGAN  
3675 Roselawn Avenue  
San Diego, California 92105

Luce Press Clippings  
PO Box 1903  
Mesa, Arizona 85201

GIDGET MADSEN  
~~4391~~ Mentone Street  
San Diego, California 92107

DONALD E. MAKOSKY  
~~PO Box 642~~  
San Diego, California 92112

JERRY MALUGEON  
8311 Keokuk Avenue  
Canoga Park, California 91306

ED L. MANGELSEN  
5153 Mission Boulevard  
San Diego, California 92109

LEO MANUEL  
~~Mesa~~ College  
San Diego, California 92111

R. & N. MARIANI  
1108 Concord  
Apartment A  
El Cajon, California 92021

JANET MATTES  
212 Shumway Street  
Lena, Illinois 61048

R. C. MAVING, JR.  
3036 Nile Street  
San Diego, California 92104

JOHN D. MAYBEE  
4695 Bancroft  
Apartment #5  
San Diego, California 92116

C. MC AULIFFE  
Mesa College  
San Diego, California 92111

Mr. and Mrs. W. MC CLURE  
PO BOX 6116  
San Diego, California 92106

WAYNE MC CRACKEN  
3663 Hondo Street  
San Diego, California 92105

D. C. MC DONALD  
9011 Garland Avenue  
Silver Springs, Maryland 20901

T. R. MC GINLEY  
Route 1, Box 779  
Escondido, California 92025

LEE MC GOUGH  
13604 Los Olivos  
Poway, California 92064

BOB MELUCCI  
4330 Austin Drive  
San Diego, California 92115

ERMA MILLER  
2038 Reed Avenue  
San Diego, California 92109

EVE MILLER  
1360 Dale Street  
San Diego, California 92102

Mrs. WAYNE MONSEES  
7785 East Roseland Drive  
La Jolla, California 92037

JOHN D. MOORE  
2740 Roosevelt Street  
Carlsbad, California 92008

JEAN MORICK  
3537 Ocean Front Walk  
San Diego, California 92109

RAYMOND MOSS  
~~4438~~ Ohio Street  
#9  
San Diego, California 92116

A. J. MUNKER  
PO Box 161  
Boulder City, Nevada 89005

Mrs. NELSON T. MURRAY  
4847 Hart Drive  
San Diego, California 92116

New Adult Community  
1924 Island Avenue  
San Diego, California 92102

R. E. NICHOLS  
Box 2385  
San Diego, California 92112

ED NOEL  
612 I Avenue  
San Diego, California 92118

Northeast Ad. Service  
1230 Arch Street  
Philadelphia, Pennsylvania 19107

Dr. and JOYCE NOWER  
4110 Gateside Road  
La Mesa, California 92041

Oklahoma Department of Libraries  
109 State Capitol  
Oklahoma City, Oklahoma 73105

VERNON K. OLIVER  
PO Box 12022  
San Diego, California 92112

JOYCE OBESMAN  
618 South Lehigh Drive  
Tucson, Arizona 85710

RICHARD PARCEL  
4301 70th Street  
La Mesa, California 92041

EMILY PARK  
1012 Lincoln Avenue  
San Diego, California 92103

MIKE PARKER  
402 63rd  
San Diego, California 92102

TED PHILLIPS  
4502 Maryland, Apt. #3  
San Diego, California 92116

GRACIA PICK  
5483 Redding Road  
San Diego, California 92115

BILL POULSON  
1604 Enfield Street  
Spring Valley, California 92077

R. PRICE  
PO Box 1511  
La Jolla, California 92037

BRUCE QUIGLEY  
5805 La Jolla Boulevard  
La Jolla, California 92037

Ravenhurst Enterprises  
709 Milo Terrace  
Los Angeles, California 90042

LYLE A. REISCHE  
PO Box 678  
Alpine, California 92001

H. D. REPLEY  
2398 Highview Lane  
Spring Valley, California 92077



Residet  
538 Oaklawn  
Chula Vista, California 92010

R. RICHARDSON  
Holla #32

Richelmann  
6278 Acorn  
San Diego, California . 92115

FORREST ROBERTSON  
1318 West 227th, #D  
Torrance, California 90501

TRUDY ROBIDEAU  
1317 Walnut Street  
Berkeley, California 94709

JACK ROBISON  
3475 Stillar Drive  
San Diego, California 92111

J. E. RUSSELL  
PO Box 981  
El Cajon, California 92022

RICHARD RUSSELL  
PO Box 1759  
La Jolla, California 92037

FRANK SAIZ  
7478 Hyatt Street  
San Diego, California 92111

GEORGE B. SCHICK  
607 North Cedros  
Solana Beach, California 92705

ROBERT N. SCHIAUG  
3705 Sioux Avenue  
San Diego, California 92117

E. J. SCHOENHALLE  
PO Box 6936  
Burbank, California 91505

WAYNE SCHUPP  
8010 Anders Circle  
La Mesa, California 92041

J. R. SCHWARTZ  
51921 Deborah Lane  
Newport Beach, California 92660

RAY SCHWARTZ  
4921 Muir Avenue  
San Diego, California 92107

R. B. SCHWITZGEBEL  
3721 Nassau Drive  
San Diego, California 92115

DUANE V. SCOTT  
120 Willow Road  
San Ysidro, California 92073

F. W. SEIDLE  
38209 Channel Drive  
Cathedral City, California 92234

CONRAD SELLE  
Box 36  
Cutler, Illinois 62238

Serials Department  
Kent State University Library  
Kent, Ohio 44240

JUNE SERMONS  
4558 North Avenue  
San Diego, California 92116

SANDEE SEVERE  
Bob 414  
Spanaway, Washington

SFL, Inc.  
PO Box 7856  
Long Beach, California 90807

RICHARD SHANNOR  
6919 Maury Drive  
San Diego, California 92119

J

Mrs. ANGELA SHEFCIK  
7030 Arilb Street  
San Diego, California 92111

Sherman's  
PO Box 23122  
San Diego, California 92123

R. E. SINNEN  
739 Island Court  
San Diego, California 92109

A. P. SMITH  
4309 Hamilton  
Hyattsville, Maryland 20781

D. L. SMITH  
PO Box 951  
La Jolla, California 92038

J. I. SMITH  
10321 Happy Lane  
Santee, California 92071

STAN SOHLER  
Box 2187  
Idyllwild, California 92349

RICHARD M. STALL  
1558 West 2nd Street  
Los Angeles, California 90028

PAUL STEIN  
Box 3321  
San Diego, California 92103

BOB STOREY  
4444 68th Street  
San Diego, California 92115

ERIC SVENSON  
PO Box 288  
Alpine, California 92001

LEONARD SHENKAN  
846 Missouri (P.B.)  
San Diego, California 92109

CHARLES SHIMEK  
1401 Mariposa  
San Diego, California 92114

HERMAN SLATER  
118 Court Street  
Brooklyn, New York 11201

DONALD H. SMITH  
3341 India  
San Diego, California 92103

GERALD SMITH  
7975 Canton Drive  
Lemon Grove, California 92045

MICHAEL G. SMITH  
4771 -68th Street  
San Diego, California 92115

W. SOLLE  
2750 Figueroa  
San Diego, California 92109

CAROL STANTON  
6455 La Jolla Boulevard, #216  
La Jolla, California 92037

JAMES STEVENSON  
5238 Imperial  
San Diego, California 92114

Suffolk Coop. Library System  
Box 187  
Bellport, New York 11713

CAROLYN SYMONDS  
3939 Newmark Avenue  
San Bernardino, California 92405

Mrs. A. TAYLOR  
301 East 29th Street  
National City, California 92050

~~DIMITRI TCHELISTCHEFF~~  
~~PO Box 1082~~  
Ensenada, B.C., Mexico

JEAN TRADER  
6869 Park Ridge Blvd.  
San Diego, California 92120

Unusual Sales Company  
Rt. 2, Box 582  
Thermal, California 92274

~~JACK VOPE~~  
945 20th Street  
San Diego, California 92102

~~Mr. WALSH~~  
Board of Supervisors  
214 Co. Admin. Cntr.  
San Diego, California 92101

~~JAMES A. WARD~~  
1511 Minden Drive  
San Diego, California 92111

~~NORMAN WATSON~~  
7957 Cornell  
Taylor, Michigan 48180

~~ANNA E. WEBBER~~  
3412 Fairmont  
San Diego, California 92105

~~VICTOR WEINER~~  
1830 Upas, Apartment #11  
San Diego, California 92103

~~JOHN H. TAYLOR~~  
1229 Via Barranca  
La Jolla, California 92037

Town House Coiffures  
8043 La Mesa Boulevard  
La Mesa, California 92041

EDWARD F. TUBBS  
5033 South 12th Street  
Arlington, Virginia 22204

~~KURT K. URBASCHEK~~  
3222 Vancouver Avenue  
San Diego, California 92104

~~DONALD L. WALLER~~  
2821 North Arroyo Drive  
San Diego, California 92103

~~KAISER C. WANSIK~~  
PO Box 223  
Chula Vista, California 92012

~~KATHERINE WARD~~  
4444 Long Branch Avenue  
San Diego, California 92107

~~CHARLES WATTS~~  
PO Box 2101  
San Diego, California 92101

~~WILLIAM P. WEEKS~~  
605 South Nardos Avenue  
Solana Beach, California 92075

~~G. WEISS~~  
I.Q. Trends  
PO Box 12160  
San Diego, California 92112

S. WEISSMAN  
7516 Parkway Drive  
La Mesa, California 92041

MELANIE WILLIS  
10386 Rancho Road  
La Mesa, California 92041

WILLIAM F. WITHROW  
212 South 2nd Avenue  
SP 15  
El Cajon, California 92021

GREG VETTER  
8859 Gardena Road  
Lakeside, California 92080

ELIZABETH P. YOUNG  
4229 5th Avenue  
San Diego, California 92103

DENNIS ZEMINSKY  
2451 1st Avenue  
San Diego, California 92101

M. WILLIAMSON  
8690 Mulvaney Drive  
San Diego, California 92119

HIRAM WINTER  
Dot Records  
1507 North Vine  
Hollywood, California 90028

RAY B. WOODMANSEE  
1324 Gregory  
San Diego, California 92102

EDWIN YOUNG  
PO Box 23402  
San Diego, California 92123

TERRY YULE  
733 Verona Court  
San Diego, California 92109

Subscribers' "Dead" File

Peninsula Observer  
180 University Avenue  
Palo Alto, California 94301

KARL C. KOHL  
222 East Quintard  
Chula Vista, California 92010

BOB BEECHER  
Box 1351  
Oceanside, California 92054

New Adult Community  
520 E Street  
San Diego, California 92101

LOU HICKEY  
2825 A Street  
San Diego, California 92101

SIMS  
7460 Girard, Suite 16  
San Diego, La Jolla, California

Poppy Records  
212 East 30th Street  
New York, New York

BRITTA LIEN  
4202 Quapaw  
San Diego, California 92117

LONNIE WIENS  
4069-1/2 Texas  
San Diego, California 92104

J. M. WARD  
825 A Avenue  
Coronado, California 92118

SUSAN TIDEMAN  
1351 Ocean Avenue  
Del Mar, California 92014

ANALEE STEWARD  
5002 Longbranch Avenue  
San Diego, California 92107

ROBERT L. SHEEHAN  
900 West Broadway  
Plainview, New York 55964

TAMSIN S. SCHULTE  
1240 Melba Road  
Encinitas, California 92024

RONNIE PAYNE  
81940 Camelot Way  
Indio, California 92201

MILTON W. NODACKER  
641 Lincoln Street  
Calexico, California 92231

ROBERT MITTEER  
Vallecito Stage Station  
Julian, California 92036

JON JORGESON  
PO Box 10079  
San Diego, California 92110

CAROLYN SYMONDS  
3939 Newmark Avenue  
San Bernardino, California 92405

Mrs. A. WHITE  
5068 35th Street  
San Diego, California 92116

MITCHELL E. TIMIN  
2344 Curlew Street  
San Diego, California 92101

E. L. SUMRALL  
940 Monserate Avenue  
Chula Vista, California 92011

PIERRE STEPHENSON  
8284 La Mesa Boulevard  
La Mesa, California 92041

TIM SCOTT  
5120 Orcutt  
San Diego, California 92120

DOUG RUBINO  
6565 Glenroy Street  
San Diego, California 92120

BARBARA PAINE  
738 Balboa Court  
San Diego, California 92109

TOM NICKEL  
730 Silvergate Avenue  
San Diego, California 92106

JOE MILLER  
9243 Shadow Hill Road  
Santee, California 92071

STEVE MC DANIEL  
2409 56th Street  
San Diego, California 92105

STEWART MARKHAM  
5484 55th, Apt. 1  
San Diego, California 92115

ROBERT A. JURAN  
501 North Rossmore  
Los Angeles, California 90004

JULIUS JOHNSON  
3148 1/2 40th Street  
San Diego, California 92105

DENNIS HILL  
3979 Alabama  
San Diego, California 92104

FANTASIA  
3022 Cedar Street  
San Diego, California 92102

GEORGE C. CHILVERS  
3667 Mississippi Street  
San Diego, California 92104

RICHARD BRUNS  
1229 De Haro Street  
San Francisco, California 94107

Dr. D. R. ARCHER  
411 Thorn Street  
San Diego, California 92103

WALLACE MAUCH  
4525 70th Street  
La Mesa, California 92041

JAMES A. KANE  
PO Box 336  
Alpine, California 92001

DONALD E. JORDAN  
1611 Highland Avenue  
National City, California 92050

MIKE IRWIN  
660 South Fairview Avenue  
Goleta, California 93926

Mr. and Mrs. W. HANSEN  
8925 Lamar Street  
Spring Valley, California 92077

R. J. ENTRINGER  
3040 Browning Street  
San Diego, California 92106

CIC  
1501 6th Avenue  
San Diego, California 92101

L. P. BROWN  
4375 Ampudia  
San Diego, California 92103

PAULETTE AMBERSON  
207 South Johnson  
Charles City, Iowa 50616

PAPERS GIVEN FREE TO INDIVIDUALS

Lowell Blankfort  
429 Third Ave.  
Chula Vista, CA 92010

Mrs. Joseph Cole  
4155 50th  
San Diego, CA 92105

Butch Cornelius  
912 Beryl St.  
San Diego, CA 92109

Gail Cornyn  
2511-1/2 Speedway  
Venice, CA 90291

Betty Downs  
4929 Wolcott  
Chicago, IL 60640

Max Herschler  
3990 S. Hwy. 85-87  
Lot #40  
Colorado Springs, CO 80909

Herschler  
1862 Woodland Ave.  
Columbus, OH 43219

Don Jackson  
325 Jeffrey St.  
Bakersfield, CA 93305

Karen, KPRI  
645 Ash St.  
San Diego, CA 92101

Bert Lazerow  
School of Law  
University of San Diego  
San Diego, CA 92110

Lyle Marsh  
325-54th St., SP. 23  
San Diego, CA 92114

Harriet Painter  
P.O. Box 508  
Little River, CA 95456

Bob Rinehart  
P.O. Box 194  
Lakeside, CA 92040

Eugene Schoenfeld  
P.O. Box 680  
Tiburon, CA 94920

Richard Stoneman  
76 Riverside Drive  
New York, NY

Ernest Twiss  
8800 Grossmont College  
El Cajon, CA 92020

B. F. Allison  
P.O. Box 369  
Santee, CA 92071

Tony Anderson  
P.O. Box 17152  
San Diego, CA 92117

Antioch College  
Yellow Springs, OH 45387

R. G. Barron  
P.O. Box 17432  
San Diego, CA 92117

Richard Bass  
612 Brooklyn  
Oakland, CA 94606

Mrs. Allen Bassett  
10565 Fuerte Dr.  
La Mesa, CA 92041

Westey Beckman  
1800 Madrid Rd.  
Las Cruces, NM 88001



R. E. Beecher  
P.O.Box 421  
Fallbrook, CA 92028

Mike Beldon  
P.O.Box 17262  
San Diego, CA 92117

Karu Beltran  
219 C  
Coronado, CA 92118

Kay Bergman  
5082 San Aquario Drive  
San Diego, CA 92109

L. Boileau  
P.O.Box 1294  
Escondido, CA 92025

Helen Bolotin  
2063 E. Lincoln Ave.  
Escondido, CA 92025

Jud Bowers  
6230 Federal  
San Diego, CA 92114

Mildred Brewer  
975 Bush, Apt. 506  
San Francisco, CA 94109

E. F. Brighty  
1009 Olive Ave.  
Vista, CA 92083

Robert Brown  
3068 Adams  
San Diego, CA 92116

Larry Brown  
3187 Ashford  
San Diego, CA 92111

Lloyd Brown  
3319 Gopher Canyon  
Vista, CA 92083

Stephan Budau  
4508 Terrace Dr. Apt. 7  
San Diego, CA 92116

Jesse Burke  
4345 Middlesex Dr.  
San Diego, CA 92116

Chris Burnam  
1141 Balour Drive  
Encinitas, CA 92025

Joseph S. Burns  
1328 Ynez Pl.  
Coronado, CA 92118

J. Burns  
5650 Hardy Ave.  
San Diego, CA 92115

Lou Byerly  
606 E. Washington  
Ann Arbor, MI 46108

Ray Byron  
2323 Elm  
Imperial Beach, CA 92032

Stephen W. Carey, 4th  
% Hotel Lyric  
140 Jones St.  
San Francisco, CA 94102

Jan Carlson  
3832-47th  
San Diego, CA 92105

Norman Casserly  
P.O.Box 8182  
Washington Station  
San Diego, CA 92102

Estelle Chacon  
914 Candlelight Place  
La Jolla, CA 92037

Dan Chevan, Jr.  
4575 Georgia  
San Diego, CA 92116

43

J

Sam Cohen  
19211 Tracey  
Detroit, MI 48235

Preston Coleman  
645 West Street  
San Diego, CA 92113

Mike Collier  
2616 Camulos St.  
San Diego, CA 92107

Wm. F. Copeland  
1217 Washington Ave.  
Burlington, WA 98233

Gwen Cook \*  
Box 578  
Ellsworth, WI 54011

D. H. Couwenberg  
Box 9544  
San Diego, CA 92109

David R. Craig, Jr.  
8800 Gardena Rd.  
Lakeside, CA 92040

Charlene Cyders  
2241 Holly Ave.  
Escondido, CA 92025

Israel David  
5113 Raleigh St.  
Hollywood, CA 90004  
Dec. 23, 1969,  
Kibbutz Ashot  
Yaacov Mevchap  
Israel

Valida Davila  
995 Broadway  
El Cajon, CA 92021

Dave Davis  
706 Nantasket Court  
San Diego, CA 92109

George Dayton  
2840 E. Tyler  
Long Beach, CA 90810

Lloyd E. Dellinger  
235 Mt. View Rd.  
El Cajon, CA 92021

Rev. Michael E. DeVore  
2770 Glebe Rd.  
Lemon Grove, CA 92045

Mike Difani  
4821 A St.  
San Diego, CA 92102

Dr. D. D. Dorfman  
309 Melrose Ave.  
Iowa City, IA 52240  
Dec. 23,  
314 Magowan  
Iowa City, IA 52240

Margaret Dudley  
2515 Sweetwater Rd. Sp.  
Space 48  
Spring Valley, CA 92077

Richard M. Dutton  
6612 Avenida de la Reina  
La Jolla, CA 92037

James D. Easton  
Box 1819  
La Jolla, CA 92037

James Edmunds  
3407 Cowley Way #3  
San Diego, CA 92117

Gary J. Emblem  
6499 Montezuma  
San Diego, CA 92115

Jere Erickson  
Box 3071  
La Mesa, CA 92041

3  
44

J

Evening Tribune-Saldana  
P.O.Box 191  
San Diego, CA 92041

John M. Feagans  
410 L Street  
Chula Vista, CA 92011

Albert F. Fertig  
5083 Conrad Ave.  
San Diego, CA 92117

Mike Fry  
2320 Palermo Drive  
San Diego, CA 92106

Harvy Furgatch  
3247 Mission Village Dr.  
San Diego, CA 92123

F. C. Gates  
525 Seabright Lane  
Solana Beach, CA 92075

M. Gizoni  
4230=42nd St.  
San Diego, CA 92105

Robert Glenn  
3901 Ocean Front Walk  
San Diego, CA 92109

D/W. Gondeck  
4201 Hamilton  
San Diego, CA 92104

Elizabeth Greenlee  
3477 Ruffin Rd., 2-F  
San Diego, CA 92123

Jean Gregg  
3640 Sepulveda Blvd.  
Los Angeles, CA 90034

Bob Greve  
22800 Republic Ave. Apt. B  
Riverside, CA 92508

Jon Gullede  
~~1835 Guy St.~~  
San Diego, CA 92110

Bob Guthrie  
~~4636 Baxter Ct.~~  
San Diego, CA 92117

Mr. & Mrs. J. Halpin  
13975 Humo Drive  
Poway, CA 92064

Hamill  
1059 University  
San Diego, CA 92103

Herbieaug Hammer  
Box 34845  
Los Angeles, CA 90034

Dick Hammes  
1520 Cliffdale Rd.  
El Cajon, CA 92020

James E. Harmon  
720 Heber Ave.  
Calexico, CA 92231

Vernon L. Harris  
1713 Evergreen St.  
San Diego, CA 92106

Sharon Harrison  
626 Maria Ave.  
Spring Valley, CA 92077

Samuel P. Hays  
1421 Wightman St.  
Pittsburgh, PA 15217

Charles J. Heim  
Box 326  
Oceanside, CA 92054

Russell Hethrington  
7735 Mission Gorge Rd.  
Santee, CA 92071

Warren Heyer  
1255 Wren  
San Diego, CA 92114

Lou Hickey  
1119 Madison St., Apt. 4  
Hollywood, CA 90029

C. Hills  
Box 483  
San Marcos, CA 92069

Ronald F. Hinz  
Box 443  
Del Mar, CA 92014

Phil Hobbes  
8815 Kenwood Dr.  
Spring Valley, CA 92077

Robert W. Holden  
6995 Galewood St.  
San Diego, CA 92120

46  
~~5~~

J

PAPERS GIVEN FREE TO ORGANIZATIONS AND BUSINESSES

~~Academy Theater~~  
3721 University Ave.,  
San Diego, CA 92105

Berkeley Tribe  
P.O. Box 9043  
Berkeley, CA 94709

ACLU  
323 W. 5th  
Los Angeles, CA 90013

The Bond  
Rm 633, 156 5th Ave.  
New York, NY 10010

~~Abortion Counseling~~  
P. O. Box 9199  
San Diego, CA 92109

Broadside  
P.O. Box 65  
Cambridge, MA 02139

~~Actors' Quarter Theater~~  
480 Elm St.  
San Diego, CA 92101

Burning River News  
% The Outpost  
13037 Euclid Ave.  
E. Cleveland, OH 44112

Roger Ahrens  
Grey Advertising  
777 Third Ave.  
New York, NY 10017

~~California Theater~~  
4th & C  
San Diego, CA 92101

Argo  
Box 11965, UCSB  
Santa Barbara, CA 93107

Campus Media, Inc.  
165 W. 46th St.  
New York, NY 10036

Ann Arbor Argus  
725 N. Univ. #7  
Ann Arbor, MI 48104

~~Capri Theatre~~  
3812 Park Blvd.  
San Diego, CA 92103

Armstrong  
P. O. Box 1186  
Torrance, CA 90505

CBS Records  
51 W. 52nd St.  
New York, NY 10019

SDSC AZTEC  
San Diego State College  
5401 College Ave.  
San Diego, CA 92115

Cinerama Theater  
5889 University Ave.  
San Diego, CA 92115

Bell Records  
1776 Broadway  
New York, NY 10019

~~Cinema 21~~  
1440 Hotel Circle  
San Diego, CA 92110

Berkeley Barb  
Box 5017  
Berkeley, CA 94715

Cinema Theater  
5500 Grossmont Center  
LaMesa, CA 92041

Ed & Sue Cobbs  
1631 Harbison Cyn. Rd.  
El Cajon, CA 92021

Loren Coleman  
Chess Records  
320 E. 21st St.  
Chicago, IL 60616

College Theater  
63rd & El Cajon Blvd.  
San Diego, CA 92115

Columbia Records  
51 W. 52nd St.  
New York, NY 10019

NMA & M Conscience  
Box 3BS  
Las Cruces, NM 88001

Cooperman, etc., Inc.  
421 5th Ave.  
Pelham, NY 10803

Stan Cornyn  
Warner Reprise  
4000 Warner Blvd.  
Burbank, CA 91505

CPR  
9124 Sunset Blvd.  
Los Angeles, CA 90069

Dallas Notes  
Box 7140  
Dallas, TX 75209

Distant Drummer  
420 South Street  
Philadelphia, PA 19147

Dot Records  
1507 N. Vine St.  
Hollywood, CA 90028

Doubleday & Co.  
277 Park Ave.  
New York, NY 10017

Druid Free Press  
2345 E. Speedway  
Tucson, AZ 85719

Kevin Eggars  
RCA/Poppy  
1133 Ave. of the Americas  
New York, NY 10036

Elektra Records  
1855 Broadway  
New York, NY 10023

Epic Records  
51 West 52 Street  
New York, NY 10019

EXTRA  
Box 2426  
Providence, RI 02906

The Fifth Estate  
1107 West Warren  
Detroit, MI 48201

Fine Arts  
1818 Garnet Street  
San Diego, CA 92109

Fontana Records  
35 E. Wacker Drive  
Chicago, IL 60601

Fox Loma Theatre  
5130 Rosécrans  
San Diego, CA 92106

Joe Gannon  
Bizarre Records  
5455 Wilshire Blvd.  
Los Angeles, CA 90036

Bob Garcia  
A & M Records  
1416 La Brea  
Los Angeles, CA 90028

48

J

Jon Gordon  
Tetragrammaton Records  
359 N. Canyon Drive  
Beverly Hills, CA 90210

Don Graham  
Blue Thumb  
427 N. Canon Drive  
Beverly Hills, CA 90210

Great Speckled Bird  
Box 7946, Sta. C  
Atlanta, GA 30309  
Jan 11, 1970:  
P.O.Box 54495  
Atlanta, GA 30308

Grossmont Col. GRIFFIN  
Grossmont College  
8800 Grossmont Col. Dr.  
El Cajon, CA 92020

Grove Press, Inc.  
80 University Place  
New York, NY 10003

Hartford's Other Voice  
Box 2424  
Bishops Plaza Sta.  
W. Hartford, CT 06117

Bill Harvey  
Elektra  
1855 Broadway  
New York, NY 10023

Heathcote School of  
Living Center  
Freeland, MD 21053

Helix  
3128 Harvard  
Seattle, Wash. 98102

Mr. Hendler  
Liberty  
6920 Sunset Lane  
Los Angeles, CA 90028

Heterodoxical Voice  
Newark Free Comm., Inc.  
P.O.Box 24  
Newark, DE 19711

The Image  
4514 Fountain  
Hollywood, CA 90029

Indianapolis Free Press  
Box 88253  
Indianapolis, IN

UCSD INDICATOR  
UCSD  
Gilman & Miramar  
La Jolla, CA 92037

Kaleidoscope  
1876 N. Sheffield  
Chicago, IL 60614

KPRI  
645 Ash St.  
San Diego, CA 92101

Barry Kramer  
Creem  
3729 Cass Ave.  
Detroit, MI 48201

KSTT, Inc.  
1111 East River Dr.  
Davenport, IA 52803

Kudzu  
P.O.Box 22502  
Jackson, MS 39205

La Jolla Library  
1006 Wall  
La Jolla, CA 92037

La Mesa County Library  
8055 University Ave.  
La Mesa, CA 92041

Stu Langer  
Dot Records  
1507 N. Vine St.  
Los Angeles, CA 90028

La' Raza  
P.O.Box 31004  
Los Angeles, CA 90031

Dennis Lavinthal  
ABC/Dunhill  
449 S. Beverly Drive.  
Beverly Hills, CA 90212

Left Speak Out  
Box 3510, Glen Sta.  
Peoria, IL 61614

Lemon Grove County Library  
7735 Pacific  
Lemon Grove, CA 92041

LNS  
160 Claremont Ave.  
New York, NY 10027

Liberation  
339 Lafayette St.  
New York, NY 10012

Light & Flower Co.  
Box 238, Village Sta.  
New York, NY 10014

In Arcane Logos  
Box 2433  
New Orleans, LA 70116

Love  
P.O.Box 5057  
Reno, NV 89502

Wm. Lucas--RCA  
1133 Ave. of the Americas  
New York, NY

Miami Free Press  
3305 Grand Ave.  
Coconut Grove, FL 33139

Mercury Records  
35 E. Wacker Dr.  
Chicago, IL 60601

Evotner of Voices  
Box 429  
Amherst, MA 01002

Nickel Review  
Box 65 University Sta.  
Syracuse, NY 13210

New Left Notes  
1608 W. Madison  
Chicago, IL 60612

News From Nowhere  
Box 501  
DeKalb, IL 60115

Moia Express  
Box 2342  
New Orleans, LA 70116

North Carolina Anvil  
P.O.Box 1148  
Durham, NC 27702

Northwest Passage  
2129 Yew St. Rd.  
Bellingham, WA 98225

NT & B  
Suite 1713  
5455 Wilshire Blvd.  
Los Angeles, CA 90036

Ode Records  
51 W. 52nd St.  
New York, NY 10019

Other Scenes  
P.O.Box 8, Village Sta.  
New York, NY 10014

Open Forum  
323 W. 5th St.  
Los Angeles, CA 90013



James C. Pagni Co.  
3605 30th St.  
San Diego, CA 92104

P. & F News  
619 S. Bonnie Brae  
Los Angeles, CA 90057

Peace & Freedom Party  
1727 W. Washington Blvd.  
Venice, CA 90291

Phillips Records  
35 E. Wacker Drive  
Chicago, IL 60601

Poppy Records  
1133 Ave. of the Americas  
New York, NY 10036

PROBE  
Box 12629, UCSB  
Santa Barbara, CA 93107

Pterodactyl  
Box 81, Grinnell College  
Grinnell, IA 50112

Pussycat Theatres  
5445 Sunset Blvd.  
Hollywood, CA 90024

Radical Research Center  
Carleton College  
Northfield, MN 55057

Rancho Drive-In  
Federal & Euclid  
San Diego, CA 92102

Rat  
201 East 4th St.  
New York, NY 10009

RCA Victor Record  
6363 Sunset Blvd.  
Hollywood, CA 90028

Rebirth  
P.O.Box 729  
Phoenix, AZ 85002

Renaissance  
Box 11668, UCSB  
Santa Barbara, CA 93107

Resistance Press  
P.O.Box 592  
Chicago, IL 60690

Richard Gersh Ass. Inc.  
200 West 57th Street  
New York, NY 10019

Riverside Library  
Corner 7th & Orange  
Riverside, CA 92501

Sawyer Press  
P.O.Box 46-653  
Los Angeles, CA 90046

Schism  
1109 W. Vine  
Mt. Vernon, OH 43050

Jack Schnyder  
1416 La Brea  
Los Angeles, CA 90028

SCN  
2700 Bancroft Way  
Berkeley, CA 94704

The Seed  
245 W. North Ave.  
Chicago, IL 60610

Bennett Sims  
Grove Press  
80 University Place  
New York, NY

SIMS  
1261 Torrey Pines Rd.  
La Jolla, CA 92037

Spokane Natural  
P.O.Box 1276  
Spokane, WA 99210

Howard Stark  
ABC/DUNHILL  
449 S. Beverly Drive  
Beverly Hills, CA 90212

Win  
339 Lafayette St.  
New York, NY 10012

S. D. Street Journal  
360 Fifth Ave.  
San Diego, CA 92101

World Publishing Co.  
119 W. 57th Street  
New York, NY 10019

Technocracy  
13761 Euclid Ave.  
Cleveland, OH 44112

Managing Editor  
Triton Times, MC250  
UCSD  
La Jolla, CA 92037

Unicorn Theater  
Box 868  
La Jolla, CA 92037

Modern Utopian  
Starr King Ctr.  
2441 Le Conte  
Berkeley, CA 94709

Valley Circle Theatre  
Mission Valley Center W.  
San Diego, CA 92110

View From Here  
2809 N. Calvert St.  
Baltimore, MD 21208

Vocations for  
Social Change  
Canyon, CA 94516

Washington Free Press  
1522 Connecticut Dr.  
Washington, DC 20005

Water Tunnel  
Box 136  
State College, PA 16801

Willamette Bridge  
522 W. Burnside  
Portland, OR 97204

52

J

Date dictated

Date received

2/6/70

Received from (name or symbol number)

[Redacted]

Received by

SA Steven L. Christensen

Method of delivery (check appropriate blocks)

in person  by telephone  by mail  orally  recording device  written by Informant

If orally furnished and reduced to writing by Agent:

Date

Dictated

2/13/70 to

Transcribed

2/16/70

Authenticated by Informant

2/17/70

Date of Report

2/6/70

Date(s) of activity

2/5/70

Brief description of activity or material

Activities of William Clay

File where original is located if not attached

770-286A

\* INDIVIDUALS DESIGNATED BY AN ASTERISK (\*) ONLY ATTENDED A MEETING AND DID NOT ACTIVELY PARTICIPATE. VIOLENCE OR REVOLUTIONARY ACTIVITIES WERE NOT DISCUSSED.

100-14293 (Clay)

770-286A - (A)

100-F2461 (MM)

157-71146

Block Stamp

SEARCHED \_\_\_\_\_ INDEXED \_\_\_\_\_  
SERIALIZED 1 FILED \_\_\_\_\_

JUN - 8 1970

FBI - SAN DIEGO

Christensen [Signature]

REPORT OF JEROME  
February 6, 1970

I talked to BILL CLAY last night. He has been out of touch since last Friday night, and could not be reached by telephone and was never at home when I went by.

Apparently some member of the Minutemen Organization or another right winger is being watched or surveilled and CLAY is quite excited about it. He thinks the FBI is doing the watching and he wants to place a surveillance on the San Diego FBI Office for the purpose of determining the times of arrival and departure of the employees and obtaining the descriptions and license plate number of FBI automobiles. He is going to try to get several people together who will be able to spend time watching the FBI Office.

*Jerome*

Date prepared

Date received

3/11/70

Received from (name or symbol number)

~~XXXXXXXXXX~~ INFORMANT

Received by

SA Steven L. Christensen

Method of delivery (check appropriate blocks)

in person  by telephone  by mail  orally  recording device  written by Informant

If orally furnished and reduced to writing by Agent:

Date

Date of Report

Dictated

3/10/70

to

3/11/70

Transcribed

3/18/70

Date(s) of activity

Authenticated by Informant

3/20/70

3/10/70

Brief description of activity or material

Names + addresses from MDM phone book obtained by MDM members, 3/10/70, at MDM office

File where original is located if not attached

170-286A

\* INDIVIDUALS DESIGNATED BY AN ASTERISK (\*) ONLY ATTENDED A MEETING AND DID NOT ACTIVELY PARTICIPATE. VIOLENCE OR REVOLUTIONARY ACTIVITIES WERE NOT DISCUSSED.

100-14892 (MDM)

Index names underlined

170-286A-3

14-91 (Resistance)

170-286A-3

Block Stamp

SEARCHED _____	INDEXED _____
SERIALIZED _____	FILED _____
JUN - 8 1970	
FBI - SAN DIEGO	

*[Handwritten signature]*

3/20/70

Following names, addresses and other information were obtained from a green canvas covered book with the inscription "Duck Power" and MDM Phone Book:

Prisoner Information Support Service  
Mark Twain Column  
P.O. Box 387  
Boston University Station  
Boston, Mass. 02215

The Realist Win Magazine Liberation  
Leuiathan

Anarchist Revolutionary Calendar  
Solidarity  
1703 Vine  
Chicago, Ill. 60614

Anti-War Groups

Black Referendum  
c/o National Comm. of Black Churchman  
110 East 125th St. Rm. 503  
New York, N.Y. 10035  
Telephone 212-862-9628

People to Call for Demonstrations

Students for a Democratic Society -  
Patti -  
Byron King 453-5754  
Veronique 459-7509

Women for Peace and Freedom  
Jane 459-2719

Social Workers -  
234-8871

Comm. to Defend Bill of Rights  
Rhetta Alexander - 262-

New Adult Community 239-2119  
Judy Brown  
Mike De Vore  
Tom Hyde

Grossmont College  
Rich Adelman 283-8358

*Jerome*

Demonstrations

ACLU -

SDSC - Keith Harrison  
Steve Barber 224-7859

San Diego State College

A.S. Pres. RON BREEN 286-6571,72  
Stud. Mob. Comm. 286-6577  
Experimental Coll. 286-6576  
Women's Lib. 286-6575  
Stan Pincetl 281-9910  
Stan Weisman

American Federation of Teachers

Bill Hulsey 420-0843

Peace and Freedom Party

Bert Halsema 422-9092

Welfare Rights Organization

Univ. of Calif. San Diego -

Bill Coates 459-0165, 453-2000 Ext. 1943

J. Stuart Innerst 459-3174

S.D.S.

Law Students

Alex Landon 282-2610

Jack Jacobson 234-2068

David Rico 222-9914

Dan Marlowe "

Bob Cowan "

Leonard Ramey 244-9202

Mothers for Peace

Sylvia Shapiro 583-1626

Dorothy Cleary 454-5637

Women's Internatl League for P. & E.

Florence Stevens 755-4283

GRAPE BOYCOTT

Carlos Le Grette 295-4200

LA RAZA

Salvador Roberto Torres 234-6008

Richard Gonsalves MIC Leave message

Individuals

DEREK CASADY

BOB and PAM MANG  
Telephone 459-7212

ERNIE MASON  
Telephone 488-7686

MARSHA and MONTE MAHAN  
Telephone 278-6546

DICK PENCE  
Telephone 282-1871

WES PAUL  
Telephone 488-1310

NANCY ROTTKE  
Telephone 277-1393

PAUL STEIN  
Telephone 281-8108  
Telephone 295-5632

MARIBETH SPEARMAN  
Telephone 281-0323

DON SCHLABACH  
Telephone 233-5045

RON SNOWDEN  
Telephone 233-7936

RON TRUJILLO  
Telephone 233-3218

DON THOMPSON  
Telephone 283-1290

Advertising

Stone Front



Dr. GEORGE ABBOTT  
Home 488-4421  
Office 291-3330

American Serviceman's Union  
ANDREW STAPP  
156 Fifth Ave. Rm. 538  
N.Y., N.Y., 10010  
Telephone 212-675-6780

RHETTA ALEXANDER  
Telephone 463-4725  
Telephone 235-9265

ACLU  
PETER CLARK

ARTISTS - helpful  
MARIE BRUMUND  
1874 Ocean Front  
Del Mar, Cal. 92014

BLASE BONPANE  
213-661-2751

ROBERT O. BLAND  
756 Bluebirth Canyon Dr.  
Telephone 494-7609

RON BREEN  
Telephone 286-6571, 2

JEFF BENJAMIN  
Telephone 453-2000 Ext AS Pres. Office

TED BUMER  
Telephone 223-8556  
Telephone 223-6313 Home

DEE BAER  
Civilian Supporter  
Teacher UCSD

BERKELEY BARB  
Box 5017  
Berkeley, Calif. 94705

STEVE BARBER  
SD STATE ACLU  
Telephone 224-7859

Los Angeles  
Black Panther Party  
(Central Communications)  
2043 E. Stockwell Ave.  
Compton, Cal.  
Telephone 635-8991  
Telephone 635-2536  
TOMMY, STEVE, ROBERT (Community Center)

KEN CLOKE  
421 Maine St. #A, Santa Monica  
Telephone 396-9801 1711 Pacific Ave., Venice 392-4177

City Transit  
Telephone 239-8161  
Mr. Garland (P.R.) 239-1251

Comm. of Small Mag. Editors and Publishers  
P.O. Box 703  
San Francisco, Cal. 94101

Prof. MICHAEL J. CAMELLA (SDSC)

Peter CLARK  
lawyer  
Telephone 234-8577

/  
BILL COATES  
Telephone 459-0165  
Telephone 453-2000 Ext 1943

TOM CSEKEY  
1136 E. Guerrero St.  
San Fran. Cal.  
Telephone 415-282-7740

ROGER CROWBRAGER  
Defenders Inc.  
Telephone 488-3026

Community of Liaison with Families of  
Servicemen Detained in North Vietnam  
365 West 42nd St.  
N.Y. City, N.Y. 10036

Coffee Houses

U.F.O. Coffee House (Ft. Jackson)  
1732 Main St.  
Columbia, South Carolina 29202  
Telephone 803-256-9438

The Oleo Strut (Ft. Hood)  
101 Avenue "D"  
Killeen, Texas • 76541

The Shelter Half (Ft. Lewis)  
5437 S. Tacoma Way  
Tacoma, Wash. 98409  
Telephone 206-GR-5-9875  
Ft. Ord

Construction

Wess Paul (Elec. Engineer)  
telephone 488-1310

Bob Eisela (Electrician)  
Telephone 283-7779 After 6:00 PM

Crash Pads for G.I.s  
Cliff and Sherry Connover  
Telephone 295-8979  
(Room for people to crash)

/  
Chula Vista Star News  
(LOWELL BLANKFORT)  
Telephone 427-3000

Concerned Students Union  
Riverside City College  
3650 Fairfax Avenue  
Riverside, Calif.

Churches for activities

Calvary Presbetyrian  
Rev. Schwitzgebel

Unitarian

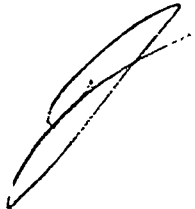

Chollas View Methodist  
Ed Hansen 264  
47th and Hilltop

YMCA

GEORGE DILLINGER, M.D.  
Psychiatrist 459-2693  
7255 Girord, La Jolla

DONALD DUNCAN  
213-783-7669  
15461 Del Gado  
Sherman Oaks, California  
91403

RON DREY  
233-2806  
Co. 25

DRAFT RESISTANCE  
DEBBIE BURTON 232-3671

BARBARA DANE  
43 Strong Rd.  
Brooklyn, N.Y. 11231  
212-855-5563

KEN DUPRE  
American Serviceman's Union  
1434 Maaloa St. Room 9  
Honolulu, Hawaii 96814

REGINA Comm. of American Deserters  
1326 Hamilton St.  
Regina, Saskat.  
Telephone 527-2787

Defenders

Alex Landon (law student)  
telephone 282-2610

Skip Miliron (student at Cal West)  
Telephone 469-4920

Dick Pence  
3003 46th St.  
San Diego, Cal  
Telephone 282-1871

LENOARD RAMEY  
(Law Student Radical)  
Telephone 244-9202

DON SCHLABACH  
Telephone 233-5045

STANELY WEISMAN  
Telephone 465-5919

DAILY AZTEC  
Telephone 286-5000

JUDY DIGGENARO  
Committee Against Fascism  
Telephone 488-5403

Entertainment

Soul Music Band  
Play at Aloha 11:30 AM  
Jesus Carranga Valdez  
Calle La B Juarez 1549  
Call Telephone 5-75-37  
Tijuana, B.C., ask for Louis

STEVE KING (SINGER)  
YWCA 233-1333  
Lifeline 233-5233  
4321 Riolto  
Ocean Beach 92110

BARBARA DANE

Band "Of the People" 213-455-2151

CHARLES GALVIN  
20800 E. Hillside Dr.  
Topanga Canyon, Cal. 90290

KEN BLOOM  
Folk singer guitarist  
(blues)

QUIN ELLIS  
"D" Company  
C & E Battalion  
MCRD

Education  
People to Wirte to for literature

New England Free Press  
791 Tremont St.,  
Boston, Mass. 02118

Radical Education Project

Young Socialist Alliance - LA

Chicago Area Draft Resistance

Fred 281-8468

Dr. WILLIAM R. FRAZER  
UCSD Biology

Fund Raising

Tom Dotty 755-7267  
1442 Camino Del Mar  
Del Mar, Cal. 92014

SYLVIA SHAPIRO  
Telephone 583-1626

PAUL STEIN  
Telephone 281-8108  
Telephone 295-5632

DON THOMPSON  
Telephone 283-4290  
4328 $\frac{1}{2}$  46th Street  
San Diego, Cal. 92115

CARL GILMAN  
4901 Marborough Drive  
San Diego, Calif.  
92116  
Telephone 283-9431

NANCY GARNER

Telephone 298-6746

G.I. Civil Liberties Def. Comm.

Box 355 Old Chelsea Station

New York, N.Y. 1011

Tel. 212-243-4775

JIM GALLOWAY SMC

Telephone 453-2000 Ext. 1943

G.I. Student Union

Joe Woodard

2214 Grove St.

Berkeley, Cal. 94704

Green Machine

P.O. Box 1356

Vista, Calif. 92083

Telephone 724-1563

MILTON IRA GREEN

23090 Parklawn

Oak Park Michigan 48237

Area Code 313-541-2147

GROCR FAWTC

222-6311 Ex. 1120 768

Good Times (undgrd, newsp.)

DANNY MONDSCHIEN

c/o Brian Kean

1666 Broadway

San Fran. Cal 94109

House of Africa

Telephone 239-5729

RON HARRIS

Telephone 225-6836

MARH HARVEY

ACLU

(Lawyer)

JIM HAWLEY

S.O.S.  
843-8209

Hawaii Resistance  
1035 University Avenue  
Room 203  
Honolulu, Hawaii 96814  
Phone 955-1026

J. Stuart Innerst  
(author and lecturer)  
Telephone 459-3174

Independent  
(Neil Good or Chet Dunnell)  
Telephone 232-3841

JIM JANUARY  
4066 234d St.  
San Francisco, Calif

ALEX JORDAN  
Telephone 437-5917  
Room 411  
(Tower 781)

KFMB (channel 8) Newsroom  
CARL GILMAN  
Telephone 232-2114  
Telephone 232-2118

KPRI  
Telephone 239-1385  
Mr. BARNARD - Station Manager

JUDY KATZ 583-4184

JOE KELLY (home) 282-8819)

WALTER H. KOPPELMAN  
8565 Duailson Dr.  
Telephone 465-5669

HAROLD KEEN  
232-2118

KCBQ  
Telephone 583-1100



Oscar Anderson  
10:00 PM  
Telephone 448-4525

JAY KING  
Telephone 465-6410

Long Beach Moratorium Comm.  
JERRY SEEDBURG  
Telephone 434-3744  
2818 E. Anahiem  
Long Beach 90804

London Ltd.  
Telephone 438-8566

Little Mexico  
Telephone 582-0139

Prof. Herbert L. Lozerow  
School of Law USD  
Telephone 291-6480

Long Beach - MDM  
JOHN FRANZONE  
2605 E. 15th  
Long Beach, Cal  
Telephone 438-0092

Liberation News Service  
160 Clairemont Ave.  
New York, N.Y. 10027

Leviathan  
2700 Broadway  
N.Y., N.Y. 10025

LINK  
1029 Vermont Ave. N.W. Room 200  
Washington, D.C. 20005

Legal  
ACLU

TED BUMIER  
223-8556  
223-6313 Home

PETE SAVITS  
Telephone 488-2828  
Telephone 454-5895 Home

JACK JACOBSON  
Telephone 234-2068 (Law Student)

DAVID RICO  
Telephone 222-9914 (Law Student)

DAN MARLOWE  
Telephone 222-9914 (Law Student)

BOB COWAN  
Telephone 222-9914 (Law Student)

S.D. STATE ACLU  
STEVE BARBER  
Telephone 224-7859

G.I. Defense Organization  
431 S. Dearborn, Suite 813  
Chicago, ILL. 60605  
Tel. 312-922-0065

G.I. Civil Liberties Def. Comm.  
Box 355 Old Chelsea Station  
New York, N.Y. 10011  
Phone 212-243-4775

Legal

Peter Clark  
Charles Curry  
Phone 234-8577

Worker's Defense  
112 East 19th St. Rm. 405  
New York, N.Y. 1003

JOHN F. MANFREDONIA  
G.I.  
Telephone 447-4386

MIRAMAR CONTACTS  
PRICE 271-3526



MAYNARD'S  
Mr. Polous  
Telephone 488-9393

DONNA MICKELSON (SDS)  
373 Green St.  
San Francisco

DUNCAN MC CARTY, M.D.  
Telephone 274-1734

Dr. MYNAM MALINOVICH,  
Telephone 459-7193

MELVON MURPHY  
Telephone 583-4641

Military Counseling  
520 E Street Room 512  
S.D. 92101 FRANK RAU  
Office 234-1305 Home 282-2302

New Mobilization Comm. To End War  
1029 Vermont Ave. N.W.  
Wash. D.C. 20005

Alphonso Macy  
Telephone 298-6618

JIM MAHONAY  
Telephone 295-9873

MDM Support Comm. L.A.  
SUSIE PACKER  
Telephone 472-2755  
Telephone 825-1394, 95  
396 N. Kenter Ave.  
Los Angeles, Cal. 90049

Frank Hagler  
Telephone 213-655-4750  
Telephone 213-936-7632

The Movement  
345 Franklin Street  
San Francisco, Cal. 94102

San Francisco Mime Troupe  
450 Alabama St.  
San Fran 94110  
Telephone 415-431-1984

Ministers

ED HANSEN  
Chollas View Methodist Church  
JIM NESSHIEM

BRUCE NEWBURGER  
1726 Lincoln Street  
Berkeley (Marxist)

Newsreel - Jonathan Aurthur  
1431 W. Washington Blvd.  
Venice, California 90291  
Office 233-9739  
Home 396-1206  
PETER 396-1206

NEWSREEL - S.F.  
541 Courtland Dr.  
San Francisco

DAVID W. NEPTUNE, Quaker  
College YMCA and YWCA  
Telephone 469-4853

DAVE NORTON  
Telephone 459-2763

North Island  
Enlisted Men's Club  
Telephone 437-7046

In event of a bust

News Media - Helpful  
PETER LARNES  
Newsweek, Fox Place Suite  
1008 San Francisco, Cal 94102

HAROLD KEEN  
Telephone 232-2118

Independent  
Neil GOOD

Channel 15  
PETER KAY 755-2209

KCBQ  
Oscar Anderson  
Telephone 583-1100

KGB  
Ted TAYLOR  
Telephone 297-2205

UPI  
Telephone 234-7111  
A.P.  
Telephone 234-7111  
Los Angeles Times  
Telephone 281-5354  
Telephone 296-0776

Chula Vista Star News  
Telephone 487-3002  
ALICE BLANKFORT  
Telephone 427-0760

Dr. PETER O'REILLY  
5757 College Ave. (Apt YY)  
San Diego, California 92120  
Telephone 286-7475

O.B. TRILOGY

(Landlord)  
I.J. OLSHER  
Telephone 232-0829  
953 8th Avenue  
Telephone 281-6078  
San Diego, Cal. 92101

JERRY POPKIN  
c/o Daily Calif.  
Berkeley, Cal.

Prof. RICHARD H. POPKIN  
Telephone 453-2797

PRINTER  
Telephone 213-330-1601  
Alfred's Newspaper Printing Co.  
14921 Proctor Ave.  
City of Industry, Cal. 91744

Photographers that want to help

11th Naval Dist.  
(P.A.) Telephone 235-3534

People's Defense Committee  
Chris KENYON 488-9917

PATRIOT PARTY  
Telephone 415-569-6370  
2812 73rd Ave.  
Oakland, Cal.

GEORGE ELGIN  
Telephone 286-9257

DOUGLAS J. PFEIL  
Telephone 748-1165

CAMERA DEFENSE - Busts etc.  
City College  
Publications Office  
JOE CHAPMAN  
PETER TUCKER  
CHUCK HUNTS

RICHARD JOSEPH ANTHONY PEIJAK  
8RI Bayridge Blvd.  
Willowick, Ohio 44094

JOCUM RICHARD ROSE  
Public Affairs Office  
Com Phib Pac  
San Diego, Calif  
92155

RUZA  
469-4887

Ramparts Magazine  
495 Beach St.  
San Francisco, Cal.

Jack RIPPER  
People's Office  
1925 Grove St.  
Berkeley, Cal 549-3977

Shore Patrol Headquarters  
Telephone 239-5158

Stone Front  
(Head)  
4820 Voltaire  
Ocean Beach, S.D.  
Telephone 223-9524

Synthetic Trips  
Telephone 282-1445

Peter Savitz  
Lawyer  
Telephone 488-2828

SYLVIA and ALEX SHAPIRO  
6952 Eldridge  
Telephone 583-1626

Rev. Richard B. Salwitzzel  
Telephone 479-2725

Mrs. Merillee Segade  
Telephone 286-3723

MARTY SCHNOEPPER  
Co 25  
Barracks 239-9760

TOM-SKI  
Telephone 271-2597

L. A. Moratorium  
Telephone 380-4085  
3848 Ingraham  
Los Angeles, Cal. 90005

Support O.S.  
P.O. Box 3061  
Oakland, Cal. 94609  
JIM HAWLEY's 843-8209  
ANDY EPSTEIN 824-1986

SDS at UCSD  
BYRONNE KING 453-5754  
BRUCE COSTON 755-3793 or 453-2000 X-2049

SPEAKERS

JOYCE NOWER

Prof. At State  
Racism Class Oppression  
Black Power, Lit.  
Telephone 463-4725

PRESCOTT NICHOLS.

Prof. at State.  
Black Lit.  
Telephone 291-1158

BOB RUSSELL

Teacher at S.D. High  
Black History  
Telephone 264-7764

AL CRISTA.

Chicano Cultural Revolution  
Chicano, Lit. and History  
Telephone 281-4838

GUS SEGADE

Chicano History, Mexican History  
Telephone 286-3723

CARLOS LE GRETTE

2422 Congress St.  
San Diego, Cal.  
(Grape Boycott Organizer)  
Telephone 262-2950

GRACIA DE PICK

Chicano Lit. (FIERY)

BILL HULSEY (AFT)

Collective Bargaining, revolution  
Telephone 420-0843

BERT HALSEMA

P & E Party, old radical  
Economy control in U.S., class nature of  
society, ecology, imperialism, revolutionary view of  
U.S. history

Ecology Action Comm



Young Socialist Alliance

Transportation

JOHN MEISTER

San Diego

Has no phone will call periodically  
has 9 people station wagon

DICK LE BRUN

telephone 239-8994

RON TRUJILLO

JANET WOOD

DEREK CASSIDY

MIC

DON EITER

USSF

United States Serviceman's Fund

(See Donald DUNCAN)

Prof HERMIT VAUDERBILT

Telephone 465-3706

Rev. NEIL VOIGHT

Telephone TU4-8508

USSF (U.S. Servicemen's Fund

430 W. 250th

Riverdale, N.Y. 10471

(212-884-3600)

P.O. Box 3061

(415-653-5820)

Oakland, California 94609

USSF

SUE SCHNALL

CORNIA FALES

Greenwich Village Peace Center

135 West Fourth Street

N.Y., N.Y.

Telephone 533-5120

Vietnam G.I.  
P.O. Box 9273  
Chicago, Ill. 60690

White Whale  
Telephone 454-6580

JARY WOODLE  
4424-51st  
Telephone 287-0269

Dr. STANLEY WEISSMAN  
7516 Parkway Dr.  
La Mesa 92041  
Telephone 465-5919

~~KINGSLEY WIDMER (AFT)  
Telephone 286-5172~~

Date prepared

Date received

Received from (name or symbol number)

Received by

3/20/70

INFORMANT

SA Steven L. Christensen

Method of delivery (check appropriate blocks)

in person  by telephone  by mail  orally  recording device  written by Informant

If orally furnished and reduced to writing by Agent:

Date of Report

Date

Dictated

4/1/70

to

3/20/70

Transcribed

4/6/70

Authenticated by Informant

4/9/70

Date(s) of activity

3/10/70

Brief description of activity or material

Names & addresses from MDM phone book obtained by MDM members at MDM office 3/10/70

File where original is located if not attached

170-286A

\* INDIVIDUALS DESIGNATED BY AN ASTERISK (\*) ONLY ATTENDED A MEETING AND DID NOT ACTIVELY PARTICIPATE. VIOLENCE OR REVOLUTIONARY ACTIVITIES WERE NOT DISCUSSED.

100-14892 (MDM)

170-286A-4

Index names underlined

170-286A-4  
Block Stamp

SEARCHED	INDEXED
SERIALIZED	FILED
JUN - 5 1970	
FBI - SAN DIEGO	

5/20/70

The following names, addresses and other information were obtained from a book with the inscription "The Book:"

Phone Numbers

Lawyers:

SAVITZ  
PETE SAIRTZ

ACLU

Office phone 488-2828

Home phone 454-5895

San Diego County Bail Fund  
(Dr. Nower)

ACLU

San Diego Committee for  
Defense of Const. Rights

ACLU, S.D. State

KEITH HANISON, Pres. 583-1026

(Might know lawyer)

MARY HARVEY, ACLU 233-0149  
(Immed. Leg. Aid for blocking  
sidewalk, etc.)

RODGER CROBARGE

State Office, Defenders Inc.

Telephone 724-1563

KEN CLOAKE

(L.A.)

CHARLES K. HOUREY

ACLU

Phone 239-8424

BRAD HETTER

Telephone 291-6970

TED BUMER

Telephone 223-8556 Office

Telephone 223-6313 Home

LON CATZ



Organizations which are friendly

YSA

ALAN STANCLIEE

Telephone 296-4029

SMC

SHERRY SMITH

JESS SMITH

Telephone 583-2762

CMC

BILL COATS

Telephone 453-2000, Ex. 1943

Telephone 459-0165

HENAC, UCLA Suzie Parcker

Telephone 825-1394

Urban Coalition League

BIL SAUNDERS

SDS DON DUNCAN

Telephone 783-7669

V.V.A.W.

Telephone 380-3611 (L.A.)

ACLU (State)

Telephone 298-6547

WALT KENNEDY (RACOP)

KEITH HARRISON, Pres.

Telephone 583-1026

The Conspiracy

Svs. H. ACHWAY

Area 361224

482471471471471436

SDS

W. C. OPLEMAN

48612510510612

612918

Conspiracy Def. Fund

28 E. Jackson

Chicago, Ill.

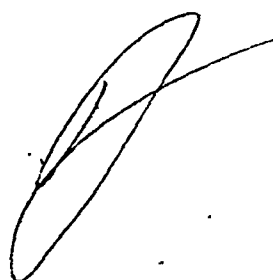

Aztec (State)  
Pol. Reporter Jim Evans  
Editor  
Bob Melton

Open City (Detroit)  
4425 2nd Ave.  
Detroit, Mich.

JOHN MARTIN, co-ordinator  
(what's happening in Detroit; good need for  
MDM in that area.)

JUDY D. IGGENNARO  
48816816510480036  
Committee Against Fascism  
Will cal Monday  
Rich radicals??

West Coast Councelling  
234-1305

Friends

Dr. and C. Olleen  
(aa/bb) (a2b2)  
229254849878916

LODGE and SHERY C. ORNOVER  
229254849878916  
(aa/bb) (a2b2)

J. LIGHTERBLACK  
24714816128164800  
(2xx)

MICHAEL D. OWNING  
bbgcfhe

BOB S. LUBLE  
egiidfi

GARY GAUBLEY  
dgaefie

BONNIE ZELL  
228264348878616  
A2b2

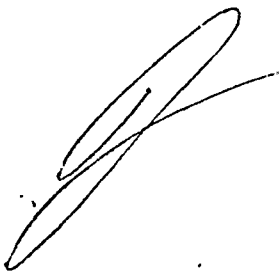

BRAD HOPHTIZER  
1232445498Happyrock  
Sylmar, Cal.  
3661271436510816612  
(x xx x) wants to start paper

JON BALKIND  
7149186121236 E 4th LA  
Wants asst. lit. on nationwide FP's

DONALD D. UNCHAN  
71481636714612  
61298  
12S104861212 Delg.

LEE ON  
4851036487142410

MICHAEL D. OWNER  
48488161271491824  
(Advertising for film)

BOB STUBLE  
2481661261251071412  
ditto

PAM WILLIAM  
248161714120071424

MIKE HEUMANN  
24816129182471412

ALAN LANE  
4871491836480048

PIGS  
Detective Division (nark)  
L.B. Watson #940 232-6981 Ex 298  
Known to have tried to get undercover agents  
Big, black, well dressed dude

Earth Child  
542 6th (Near Market)  
Apt. 24

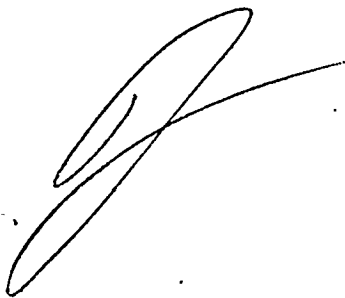

JANE B. ROWN  
24714816128164800  
Hwy. 36918510 to x

BARB HOWARTH  
4871491848714510816

DOUG RECHARD

MIKE H. EUMANN  
24816129182471412

Poli. Sci. Class

BRUCE COSTON (SDS)  
~~755-3793~~  
or 453-2000 x 2049

SUSY WEINSTEIN  
Keri Krust  
State Coll.  
24816363671400918

JOHN HANAHER  
24369K2451081600  
1245 16th Ave.  
MCRD

Violence must result only as a direct result of aggression in order to prevent false images of riotous tendencies.

We are not, and will not be, a leftist "minutemen" organization.

PP 157 C15 #1 1938

Publisicty

Free Presses National  
and Good papers and local  
HAROLD KEEN  
KGB Radio

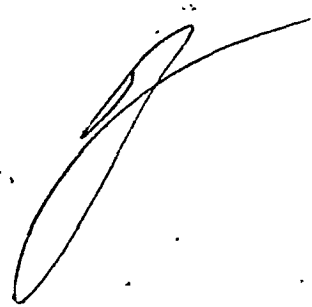



SHERWOOD GORDON  
KSDO Radio

UCLA BRIAN "TODD" 825-2020  
308 Westwood Pky.  
90024 c/o Brian  
RICK HEIR letters to Editor

Good Times  
2377 Bush St.  
S. Fran.

234-7111, ext. 350  
Friendly Reporter

People's Bread 145.00 balance  
Feb 13 expenses 2.50 gas  
1.82 groceries

A large, stylized handwritten signature in black ink, located in the lower right quadrant of the page. The signature is cursive and appears to be a name, possibly 'R. Gordon' or similar, though it is difficult to decipher due to its fluidity.

Date prepared

Date received: 3/17, 3/20, 3/23/70

Received from (name or symbol number) ~~XXXXXXXXXX~~ INFORMANT

Received by SA Steven L. Christensen

Method of delivery (check appropriate blocks)
 in person  by telephone  by mail  orally  recording device  written by Informant

If orally furnished and reduced to writing by Agent:

Date of Report 3/17, 3/20 + 3/23/70
Date(s) of activity

Dictated 4/1/70 to

Transcribed 4/6/70

Authenticated by Informant 4/9/70

3/14-20/70

Brief description of activity or material
Pro. CP material at Scripps Oceanography
Contact with Jerry Tartaglio, Santa Ana
Activities from 11/2/69

File where original is located if not attached
170-286A

\* INDIVIDUALS DESIGNATED BY AN ASTERISK (\*) ONLY ATTENDED A MEETING AND DID NOT ACTIVELY PARTICIPATE. VIOLENCE OR REVOLUTIONARY ACTIVITIES WERE NOT DISCUSSED.

- 100-12151 (MM) 157-1748
100-286A-5
100- (Jerry Tartaglio)
100-14661 (Frank Yacopac)
100- (CP)
157-800 (Herschler)

170-286A-5 Block Stamp

SEARCHED - INDEXED -
SERIALIZED - FILED -
JUN 2 1971
FBI - SAN DIEGO

to be prepared

March 17, 1970

BY JEROME

*SD 112-578*

I was at Scripps Institute of Oceanography a couple of days ago on business and toured a considerable part of the facilities. I had occasion to observe a large amount of pro-Communist literature and references on the bulletin boards. In a number of classrooms I observed the slogan "The only true freedom is true Communism, Communism, Communism," written on the blackboards.

March 20, 1970

By JEROME

*3/20/70*

I am going to be spending Friday evening and all day Saturday at Los Angeles, California. On the way, I intend to stop in Santa Ana and contact JERRY TARTAGLIO and make his acquaintance.

March 23, 1970

By JEROME

*151-0148*

I got in touch with JERRY TARTAGLIO last Friday evening at his home at *1721 Gunther, Str. Ave, tel. 531-610*. He appears to have many contacts in both the right and left wing elements in the Orange County and Los Angeles, California, area. In particular, he has a contact with a young Jewish fellow who belongs to the SDS somewhere in the Los Angeles area. This person, whose name I did not learn, sells weapons and explosives to anyone who has the money to pay for them. I was told he has hand grenades for sale at about \$5.00 apiece, which is half what they are selling for in San Diego. In large quantities of 100 or more he will reduce the price to \$2.50 to \$3.00. I learned that FRANK YACOPL was at the San Diego County Recorder's Office today and determined that DALE HERSCHLER owns the building where he published the San Diego Free Door. However, HERSCHLER's place of residence for tax purposes was shown as 7053 University, La Mesa, California.

*Jerome*

Date prepared

Date received

Received from (name or symbol number)

Received by

3/25, 3/26/70

INFORMANT

SA Steven L. Christensen

Method of delivery (check appropriate blocks)

in person  by telephone  by mail  orally  recording device  written by Informant

If orally furnished and reduced to writing by Agent:

Date of Report

Date

Dictated

4/1/70

to

3/25 + 3/26/70

Date(s) of activity

Transcribed

4/6/70

Authenticated by Informant

4/9/70

3/24 - 25/70

Brief description of activity or material

Info re Bill Clay + Frank Yacopac  
Ted Wolfe.

File where original is located if not attached

170 - 286A

\* INDIVIDUALS DESIGNATED BY AN ASTERISK (\*) ONLY ATTENDED A MEETING AND DID NOT ACTIVELY PARTICIPATE. VIOLENCE OR REVOLUTIONARY ACTIVITIES WERE NOT DISCUSSED.

100-14293 (Clay)

170-286A-6

100- (Jerry Tartaglio) (1) per [unclear]

100-14661 (Yacopac)

100- (Ted Wolfe) (1) per [unclear]

170-286A-6  
Block Stamp

SEARCHED INDEXED  
SERIALIZED FILED  
JUN 5 1970  
FBI - SAN DIEGO

March 25, 1970

By JEROME

I was talking with BILL CLAY last night and he is highly interested in JERRY TARTAGLIO and believes he would be an excellent contact. CLAY intends to be in Los Angeles, California, over Easter weekend; Friday, Saturday, Sunday and Monday and he wants me to arrange a meeting with TARTAGLIO at the west end of the bridge over Interstate 5 at Knott's Berry Farm at 9:00 a.m., Saturday morning, March 23, 1970.

*3/24-25/70*

March 26, 1970

By JEROME

I have learned that FRANK YACC<sup>ec</sup> was at TED WOLFE's gun shop (Lyle Manning's Hanging Tree Swap Shop) yesterday and WOLFE showed him a new M-14 rifle which he would sell for \$125. WOLFE does not have the rifle at his store but drove away in his camper pickup truck and obtained the rifle and returned after a short time. He then showed the rifle to YACC in the back of the camper after which he apparently returned it to the place where he had obtained it.

*(Curry (Manning))*  
*(Ted Wolfe)*

*Jerome*

SEARCHED \_\_\_\_\_  
SERIALIZED \_\_\_\_\_  
INDEXED \_\_\_\_\_  
MAR 28 1970  
FBI - LOS ANGELES

Date prepared

Date received

3/31/70

Received from (name or symbol number)

INFORMANT

Received by

SA Steven L. Christensen

Method of delivery (check appropriate blocks)

in person  by telephone  by mail  orally  recording device  written by Informant

If orally furnished and reduced to writing by Agent:

Date

Dictated 4/1/70 to \_\_\_\_\_

Transcribed 4/6/70

Authenticated by Informant 4/9/70

Date of Report

3/31/70

Date(s) of activity

3/10/70

Brief description of activity or material

Names & addresses from MDM phone  
Book obtained by MDM members at  
MDM office 3/10/70

File where original is located if not attached

170-286A

\* INDIVIDUALS DESIGNATED BY AN ASTERISK (\*) ONLY ATTENDED A MEETING AND DID NOT ACTIVELY PARTICIPATE. VIOLENCE OR REVOLUTIONARY ACTIVITIES WERE NOT DISCUSSED.

100-14892 (MDM)

170-286A-7

Index names underlined

Block Stamp

170-286A-7

SEARCHED	INDEXED
SERIALIZED	FILED
JUN - 3 1970	
FBI - SAN DIEGO	

*[Signature]*

3/31/70

The following names, addresses, and other information were obtained from a small white book bearing the inscription Phone Book of Civilian Helpers with MDM:

ACLU  
Perry Langford  
telephone 223-3863  
Telephone 233-5409

RHETTA ALEXANDER  
(Women's Lib)  
telephone 262-8422

RICH ADELMAN  
Prof. at Gros'smont College  
Telephone 283-8358

JANE ELLIOTT  
755 Loma Valley  
San Diego, Cal. 92106  
Telephone 223-9898

JACK BREMNER  
(minis.)  
Christ the King Church (Catholic)  
32nd and Imperial  
Telephone 233-0700

MARIE BRUMUND  
Artist (wants to help)  
1847 Oceanfront  
Del Mar, Cal. 92014  
Telephone 755-7262

NICK and WANN BOYLAN  
3833 Costa Bella  
Lemon Grove, Cal. 92045  
Telephone 469-4920

JANET BROWN  
Telephone 278-1840  
Wants to Help

PETER BARNES  
News Media  
Newsweek, Fox Plaza Suite 1008  
San Francisco, Cal. 94102

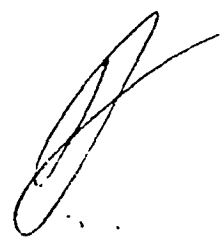

RON BREEN

AS Pres. San Diego State  
Telephone 286-6571

DOZEN'S HOUSE

MIKE DEVORE

(Electricity)  
Telephone 235-9265

BONNIE DONOVAN

609 Fern Glenn  
La Jolla, Cal. 92037

DONALD DUNCAN

15461 Delgado Dr.  
Sherman Oaks, Cal. 91403  
Telephone 783-7669

TOM DOTY

1442 Camino Del Mar  
Del Mar, Cal. 92014  
Draft Counseling  
UGSD stu. Fund raising  
Telephone 1-755-7267

BILL COATS

Chaplain UCSD  
CMC  
Telephone 459-0165  
Telephone 453-2000  
Ext. 1943

DOROTHY CLEARY

Helpful lady  
Telephone 454-5637

DEREK CASADY

Will Help  
Telephone 488-9712

MARY LYNN CLEMENT

8180 Vincetta Dr.  
La Mesa, 92041  
Women's Lib.  
Telephone 463-6968

Citizen's United For Racial Equality

Mrs. Margolis  
Telephone 279-8809



CRISIS CENTER  
FREE CLINIC MWF - 6 - 10  
Telephone 239-0325

ANGELA DAVIS  
213-737-6932

DEFENDERS INC.

DREY, RON.  
c/o Evan Evans 2915 Rutland  
Des Moines, Iowa 50311

GEORGE ELGIN  
(Photographer)  
Telephone 286-9257

DON EITER  
Trans. Typewriter  
Telephone 233-9453

JARRY FARBER  
Non-Violent Action  
Author of "Student as Nigger"  
Telephone 465-1178

HARVEY FURGATCH

JACKY FRIEDLAND  
Days Free  
Wants to help  
Telephone 283-9100

SYDNEY GLASS

FRANK HAGLER  
MDM Support Comm  
650 South Detroit Apt. 207  
Los Angeles  
Telephone 213-655-4750  
Telephone 936-7632

ED HANSEN (Minister)  
Chollas View Methodist Church



BILL HULSEY  
835 Halecrest, Chula Vista  
AFT, radical, P&E Party

BERT HALSEMA  
P.O. Box 104, Nesten, Cal.  
Radical, D & F Party  
Telephone 422-9092

TOM HYDE  
New Adolf Comm, radical

JIM HAWLEY  
P.O. Box 3061, Oakland, Cal.  
Support our Soldiers in S.F.  
Telephone 415-843-8209

J. STUART INNERST  
(Quaker)  
5840 Camino De La Costa  
La Jolla, Cal. 92037  
Telephone 459-3174

HEENAC  
Telephone 213-825-1394, 95

RON KEY  
(Construc.)  
Telephone 488-6179

STEVE KING  
(Entertainment)  
(Singer)  
YWCA  
Lifeline  
4321 Riolto  
Ocean Beach, 92110  
Telephone 233-1333  
Telephone 233-5233

CHRIS KENYON  
Telephone 488-9917

JAY KING  
Telephone 465-6410

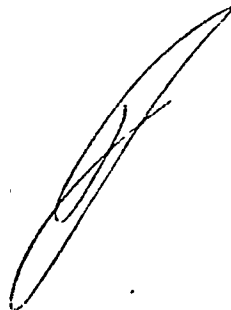

ALEX ALNDON

(Law Student)

Defenders

Telephone 282-2610

PHYLLIS LA GRANGE

DICK LE BRUN

(Trans.)

(Will help take G.I.s to functions and take them out when pig gets heavy)

Telephone 239-8994

DONNA MICKELSON

373 Green St.

San Francisco, Cal.

Telephone 415-434-1619

GEORGE MERCER

La Jolla, Cal.

DAWN MC CURIO

6342 Imperial Ave. S.D. 92115

Telephone 264-5835

PAM MANG

Fund Raising

Telephone 459-7212

EARNEST MASON

(Fund Raising Possibility?)

Telephone 488-7686

SKIP MILLIRON

(Student at Cal West.)

Defender

Telephone 469-4920

JACK RIPPER

People's Office 1925 Grove St.  
Berkeley, Cal.

MONTE MAHAN

3435 Dorchester Dr.

SD

Friends

Telephone 278-6546

MICHA MAGUIRE  
10712 Wilshire Blvd.  
Los Angeles, Cal  
Messages 473-0059  
Prisoners Hght.  
Telephone 213-474-4300

JIM NESSHIEM.  
Lutheran Campus Center  
5863 Hardy Dr 92115  
Telephone 583-3972  
Telephone 286-1945

New Adult Comm.  
Exposure Education  
1924 Island Ave S.D. 92102  
Telephone 238-2119

Prescott Nichols  
1787 Neale St., San Diego  
Rad. Prof. at State (Black Literature)  
Telephone 291-1158

LEON NOWER  
Prof. at State - Radical  
Telephone 463-4725

WALT PARKMAN  
Telephone 448-5093

DICK PENCE  
Defender  
3003 46th Street  
San Diego, Cal.  
Telephone 282-1871

STAN PINCETL  
Prof.  
Telephone 281-9910

WES PAUL  
Elec Engineer  
Telephone 488-1310



DOUGLAS J. PFEIL  
Photographer  
Telephone 748-1165

SUSIE PACKER  
396 N. Kenter Ave.  
LA., Cal. 90049  
Telephone 478-8929  
Telephone 472-2755  
Telephone 825-1394  
Telephone 825-1395

GRACIA DE PICK  
Articulate on Chicano Lit.

PATTI PARMELEE  
Massachusetts  
Telephone 213-938-9347

JERRY PETERSON  
280 K St.  
Chula Vista, Cal.  
Telephone 427-7248

JOAN ROTTER  
1151 14th St.  
Imperial Beach 92032  
Telephone 424-7470

NANCY ROTTKE  
6750 Beadnell Way Apt. 49  
San Diego 92117  
Telephone 277-1393

LEONARD RAMEY  
Law Student Radical  
Defender  
Telephone 244-9202

ROGER RUFFIN  
Judge - get O.R.s from  
telephone 459-6374

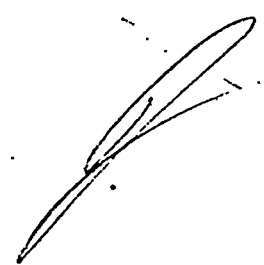

SYLVIA SHAPIRO  
Fund-raising  
Telephone 583-1626

PAUL STEIN  
Fund-raising  
Telephone 281-8108  
Telephone 295-5632

MARIBETH SPEARMAN  
4273 Highland Ave.  
Apt #2  
San Diego, Cal. 92115  
Telephone 281-0323

FLORENCE STEVENS  
Women's International League for P & E  
Telephone 755-4283

DON SCHLABACH  
Defender  
Telephone 233-5045

ALAN STANCLIFF  
YSA  
Telephone 296-4029

Support Our Soldiers  
373 Green St.  
San Francisco, Cal.,

RON SNOWDEN  
(plumber)  
Telephone 233-7936

Students for a Democratic Society  
1608 W. Madison  
Chicago, Ill 60612

RON TRUJILLO  
2674 Island Ave.  
San Diego, Cal. 92102  
Telephone 233-3218

LINDA TYLER  
6288 Stanley Ave.  
San Diego, Cal. 92115  
Telephone 286-9651

DON THOMPSON

(Fund raising)  
4328½ 46th Street  
San Diego, Cal. 92115  
Telephone 283-4290

JOHN WELDON

Telephone 488-9468

WESLEY Foundation  
5225 Campinile, S.D.  
Radical Center at State  
Telephone 582-0772

STANLEY WEISMAN

Prof Defense  
Telephone 465-5919

GLEN WORSTELL

12340 Oak Knoll Rd.  
Poway, Cal 92064  
Stud. at State  
Telephone 748-2714

NANCY and PETER WEILER

1431 Inspiration Dr.  
La Jolla, 92037  
Telephone 459-7632

JIM WALDECK (typewriter) (Learner by GRANT).

Telephone 286-3836

RON WARREN

JUDI SHAYNE

Liberation Union MDM Support

Place to crash in L.A.

13107 Margate  
Van Nuys, Cal. 91401  
Telephone 783-3861

MILT ZAZLOW

3824 Evans St., Los Angeles 90027  
C.P. In Los Angeles  
Telephone 213-662-7269



High School Students

JOAN ROTTER  
1151 14th Street,  
Imperial Beach, 92032  
Telephone 424-7470

REBECCA BURNETT  
3232 Elliott  
San Diego, 92106  
Telephone 222-3330

NANCY ROTTKE  
6750 Beadnell Way Apt. 49  
San Diego, Cal. 92117

IRV ALPERT  
Telephone 287-0264

WALT PARKMAN  
11675 Oak Creek Dr.  
Lakeside, California 92040  
Telephone 448-5093

LISA KATZ  
5640 Dorothy Way  
San Diego, Cal. 92115  
Telephone 583-4184

JIM GRIPP  
4441 Carmén Dr.  
La Mesa, Cal. 92041  
Telephone 442-3532



Date prepared

Date received

2/5/70

Received from (name or symbol number)

INFORMANT

Received by

SA Steven L. Christensen

Method of delivery (check appropriate blocks)

in person  by telephone  by mail  orally  recording device  written by Informant

If orally furnished and reduced to writing by Agent:

Date

Dictated

2/13/70

to

Date of Report

2/5/70

Transcribed

2/16/70

Authenticated by Informant

2/17/70

Date(s) of activity

2/5/70

Brief description of activity or material

Activities of Frank Yacofec, Paul Ruplinger & Peter Ruplinger

File where original is located if not attached

170-286A-5  
~~170-286A-5~~

\* INDIVIDUALS DESIGNATED BY AN ASTERISK (\*) ONLY ATTENDED A MEETING AND DID NOT ACTIVELY PARTICIPATE. VIOLENCE OR REVOLUTIONARY ACTIVITIES WERE NOT DISCUSSED.

105-14661 (Yacofec)

770-286A-5

100-14301 (Ruplinger)

100-14356 (Peter Ruplinger)

100-14911 (Peoples Commune)

170-286A-8

SEARCHED <input checked="" type="checkbox"/>	INDEXED <input checked="" type="checkbox"/>
SERIALIZED <input checked="" type="checkbox"/>	FILED <input checked="" type="checkbox"/>
JUN - 8 1970	
FBI - SAN DIEGO	

REPORT OF JEROME  
February 5, 1970

I learned today that FRANK YAKOPEC found a dead skunk on the road yesterday which he picked up, placed in a cardboard box, which he then wrapped in a plastic bag, and born paper on the outside. He mailed this package from the Del Mar Post Office yesterday addressed to JAN DIEPERSLOOT at the Peoples Commune.

He was told that the Minutemen are going to try to begin printing a news leaflet that publicizes names and activities of interest among the left wingers.

I talked to PAUL RUPLINGER this morning who said he would like to get some kind of harassment going again against Professor MARCUSE at UCSD. RUPLINGER also said that his son PETER RUPLINGER has a close personal friend who he knows has been informing on both left and right wingers for the FBI, for about a year. RUPLINGER said he intends to make this person's name known to a number of people so as to destroy his activities as an informant.

*Jerome*

Date prepared

Date received  
3/6/70

Received from (name or symbol number)  
INFORMANT

Received by  
SA Steven L. Christensen

Method of delivery (check appropriate blocks)

in person  by telephone  by mail  orally  recording device  written by Informant

If orally furnished and reduced to writing by Agent: Date

Date of Report  
3/6/70

Dictated \_\_\_\_\_ to \_\_\_\_\_

Transcribed \_\_\_\_\_

Authenticated by Informant \_\_\_\_\_

Date(s) of activity  
3/5/70

Brief description of activity or material  
CMC planning meeting  
3/5/70

File where original is located if not attached  
170-286A

\* INDIVIDUALS DESIGNATED BY AN ASTERISK (\*) ONLY ATTENDED A MEETING AND DID NOT ACTIVELY PARTICIPATE. VIOLENCE OR REVOLUTIONARY ACTIVITIES WERE NOT DISCUSSED.

100-14922 (CMC)  
170-286A-9

~~index~~: Freitjof Thygeson  
100-150630

- 100-14862 (Coats)
- 100-14495 (Stancliff)
- 100-13697 (Shapiro)
- 100-14527 (Seuter)
- 100-14075 (Bergman)
- 100-14376 (St. Journal)
- 100-14892 (MDM)
- 100-13378 (William Milson)

Block Stamp

170-286A-9

SEARCHED	INDEXED
SERIALIZED	FILED
JUN 5 1970	

Christensen

MARCH 6, 1970

BY JEROME

I attended the CMC planning meeting in Balboa Park last night. I got there at about 7:10 but the meeting did not get going til 7:35. There were approximately 50 to 60 people present. The meeting was chaired by the Reverend BILL COATS. I saw FREITJOF THYGESON there, however, he left early, in disgust.

I also recognized ALAN STANCLIFF, SYLVIA SHAPIRO and BERNIE SENTER in the crowd. Also present was a young white individual in his early 20s with long dark brown hair. He was wearing a fatigue jacket with red stars on the collar. I heard him refer to as "LLOYD" and he said he was a representative of the San Diego Street Journal.

(Lowell  
Bergman)

Two other persons who spoke at the meeting claimed to be representatives of MDM. One was a clean cut white male with a military look, medium build, about 5'9" tall. He has light colored hair and wearing a Mao-tse-tung style quilted cap. The other was also about 5'9" tall, medium build, long blond hair who wore gold rimmed glasses; a red jacket and camouflage pants.

It was decided there would be city wide peace activity during the week of April 13 to 18, 1970. However, there was a lot of arguments and backbiting as to whether the actual peace march should take place on April 15 or April 18, 1970. It was agreed the march should probably start at noon and that it would be a flop if less than 8,000 people showed up.

The MDM representative with the Mao tse-tung cap was screaming that people from the military and people with jobs could not come of the rally was held on the 15th, a Wednesday, and finally the MDM and Street Journal people walked out of the meeting. After they left, there was some discussion about a possible compromise where the rally would be held on Wednesday evening and servicemen would be bussed to it.

Before they left, the people from the Street Journal announced that they had moved into new offices but were evicted the same day after the police department talked to their new landlord. They said that they had an offset place which they would use to make posters for the April demonstration.

Jerome

(Lowell Bergman)

"LLOYD" from the Street Journal predicted there would be a breakup in San Diego in the near future due to police department harassment.

During the meeting, it was announced that there would be efforts made to organize a city wide student strike at high schools on April 15, 1970.

It was also announced that MDM would have a mock trial of the military on April 1, 1970, which will be composed of active duty GIs and with MARK LANE as prosecutor.

It was eventually decided that the April demonstration would again consist of a march from downtown San Diego to a rally in Balboa Park.

People were asked to volunteer to work on the various planning committee.

One interesting thing that occurred was a speech by a man from the audience who claimed that the November 15, 1969, demonstration in San Diego was nothing more than a disorganized mob. He said the planning for the peace demonstration was all wrong and that the demonstration should be held on a weekend so workers could join in. He said the people at the meeting should do as had been done where, he said, groups of 30,000 to 40,000 workers had been organized to march down the streets chanting.

This individual seemed to be well known, was a white male, about 60 years old, gray hair, 5'7", and stocky built. He had a flat, round face and spoke with a heavy European accent.

There were no colored people at the meeting.

*Jerome*

Date prepared

Date received

Received from (name or symbol number)

Received by

3/11/70

INFORMANT

SA Steven L. Christensen

Method of delivery (check appropriate blocks)

in person  by telephone  by mail  orally  recording device  written by Informant

If orally furnished and reduced to writing by Agent:

Date of Report

Date

3/9 + 3/11/70

Dictated \_\_\_\_\_ to \_\_\_\_\_

Date(s) of activity

Transcribed \_\_\_\_\_

Authenticated by Informant \_\_\_\_\_

3/9 + 10/70

Brief description of activity or material

Info re Frank Yacopiec;  
MDM & SMC

File where original is located if not attached

170-286A

\* INDIVIDUALS DESIGNATED BY AN ASTERISK (\*) ONLY ATTENDED A MEETING AND DID NOT ACTIVELY PARTICIPATE. VIOLENCE OR REVOLUTIONARY ACTIVITIES WERE NOT DISCUSSED.

100-157-1527 (Frank Yacopiec)  
170-286A-10  
100-14892 (MDM)  
100-13847 (SMC)

Block Stamp

170-286A-10

SEARCHED <input checked="" type="checkbox"/>	INDEXED <input checked="" type="checkbox"/>
SERIALIZED <input checked="" type="checkbox"/>	<input checked="" type="checkbox"/>
JUN 5 1970	

*Christensen*

MARCH 9, 1970

BY JEROME

I have learned that FRANK YACOPEC is getting back together with his family and is planning to move into a rental house on Graves Street in El Cajon. He is supposed to be getting a full time employment and may settle down a little bit.

MARCH 11, 1970

BY JEROME

I stopped by the MDM Office at 429 J Street last night at about 6:45.PM. The place was in mass confusion as there was a camera and some CBS TV Channel 2 people. I learned that they were filming coverage of MDM for a nation wide broadcast to be aired on CBS in the near future.

I also learned that SMC may be planning some kind of anti-draft activity for the middle of this month.

*Jerome*

Date prepared

Date received  
3/12; 3/16;  
3/18/70

Received from (name or symbol number)

INFORMANT

Received by

SA Steven L. Christensen

Method of delivery (check appropriate blocks)

in person  by telephone  by mail  orally  recording device  written by Informant

If orally furnished and reduced to writing by Agent:  
Date

Date of Report

Dictated \_\_\_\_\_ to \_\_\_\_\_

3/12; 3/16; 3/18/70  
Date(s) of activity

Transcribed \_\_\_\_\_

Authenticated by Informant \_\_\_\_\_

3/12 - 17/70

Brief description of activity or material

Demonstration at SDSC  
3/12/70

File where original is located if not attached

170-286A

\* INDIVIDUALS DESIGNATED BY AN ASTERISK (\*) ONLY ATTENDED A MEETING AND DID NOT ACTIVELY PARTICIPATE IN VIOLENCE OR REVOLUTIONARY ACTIVITIES WERE NOT DISCUSSED.

100-14998	(Demo. SDSC, 3/12/70)	Index:
170-286A - 11		Steve Nystrom
100 -	(Karl Keller) <sup>speech</sup> <sub>100-15063</sub>	Freitjof Thygeson
157-890	(Rhett Alexander)	Bernard Streif
157-891	(Ron Green)	
100-14527	(Bernie Jansen)	
100-14495	(Alan Stancliff)	
157-699	(Sukumo)	

Block Stamp

170-286A 11

SEARCHED	INDEXED
SERIALIZED	FILED
JUN 5 1970	

Christensen [initials]



3/12/70  
JEROME

A demonstration began today at San Diego State College and students from the school took over part of the administration building and at one time there were close to 700 students there with more expected to arrive after 4:00 p.m., when classes were out. It has the earmarks of lasting for a long time.

The demonstration was touched off at about noon by a speech given by KARL KELLER at a rally on the library loan. The students are protesting administrative action taken by the school against four professors there.

Food including apples, oranges, carrots, punch and loaves of bread is being passed around in the building and is apparently being prepared at the Wesleyan Foundation Building. Signs have been put up in the building indicating that the restrooms have been "liberated" and are now co-educational. Some marijuana was seen being passed out free. About 100 students have elected to stay over night and are going home in shifts to obtain sleeping bags and other items.

The demonstration appeared to be well planned and some organizers, including RHETTA ALEXANDER for one, were seen communicating with walkie-talkies. Other persons observed taking part in the demonstration were RON BREEN, STEVE NYSTROM, BERNIE SENTER, ALAN STANCLIFF, SUKUMO and FRIETJOF THYGESON.

3/16/70  
JEROME

I stopped by State College about 11:00 p.m. last night. There were about 75 students in the halls of the administration building who were painting 30' long banners and placing them on the walls of the administration building. They were also printing leaflets announcing a rally at noon today on campus. LEON NOWER was observed there holding hands with a young girl. BERNARD STREIFF, the french student who claims to have participated in the french student revolt, was also there.

*Jerome*

3/18/70  
JEROME

It has been learned the demonstration at State College has been terminated after students and administration officials reached a compromise on a future course of action to be taken regarding hiring and firing of faculty members.

*Jerome*



APRIL 15, 1970

BY JEROME

I met an interesting individual at BILL CLAY's house last night. He is called "The Judge" and his first name is JERRY. He is about 5'10", to 5'11" tall, 230 pounds, has heavy built, ruddy complexion and is 35-45 years old. He has black hair which is receding, a pug nose, round face and heavy jowels. He carries a brown and .32 automatic pistol and is apparently an excellent shot.

He said he spent 8 years in military intelligence following which he worked for the CIA and then for the FBI at San Diego as an informant. He claimed he was a paid assassin for the CIA. He seemed to be highly intelligent and I was told he was good at make-up and voice imitations. He said he had worked at Hollywood as a bit player.

He claimed that when he worked for the FBI at San Diego, he was assigned to watch TROY HOUGHTON and that he quit at about the time of the Watts riot in Los Angeles. He said he was never a close acquaintance of HOUGHTON but he had followed HOUGHTON a lot and came to the personal conclusion HOUGHTON was a Communist. He seems almost to have convicted CLAY of this also.

As CLAY stated, he had verified that HOUGHTON had been meeting some known members of the Communist Party. BUSH and CLAY were thinking DE PUGH may have become aware of this and had HOUGHTON eliminated. If this is so, CLAY said he was thinking about contacting DE PUGH and humbly apologize for ~~was~~ trying to break away from the national MM organization.

"The Judge" is supposed to be from Virginia, although he has no accent, and apparently hates colored people. He speaks fluent German and Spanish.

CLAY stated he believes one of the leading Leftists in the area is MORRIS KOMINSKY who lives at 400 East Franklin Street, Elsinore, California. He has written a book which is being advertised in papers like the Free Door and the Street Journal. KOMINSKY allegedly moved in high circles in the Federal and local Governments at one time and has supposedly been visited on numerous occasions, high placed Government people, including Congressmen, Senators, and Presidents such as TRUMAN, EISENHOWER, and KENNEDY.

CLAY said he wants some local Right Wing people to visit KOMINSKY and somehow get his signature.

*Jerome*



MAY 1, 1970

BY JEROME

Today, I went with "The Judge" to see MORRIS KOMINSKY. KOMINSKY is an order man, 60-70 years of age, about 5'9" tall, curly black hair which has a lot of gray in it, blue eyes. He weights 160-170 pounds, has poor posture, as he slouches and has a pot belly. From his statements, I gathered that he is very much in favor of what the San Diego Street Journal is doing. He said he gave all his records to the Street Journal and claimed that it took 5 Street Journal staff members 8 hours to copy his notes of the San Diego area alone. He claimed he had much more information on Right Wing activities in America and claimed he has spent five years researching information for his new book which will be called "Count Down, USA." He said the first volume of this book which will be an expose on fascism in the United States, will be 800 pages long and the second volume will be 1300 pages long. He seemed to be pleased to talk about his work and as we reported ourselves to be fans of the Street Journal, opposed to fascism, he talked quite freely.

He told us of contacts he has in the San Diego Police Department, of the San Diego District Attorney's Office, and also claimed to have a source of information in the San Diego FBI Office.

KOMINSKY said he formerly had high placed friends in Government and claimed he had been visited at his home in Elsinore by Presidents of the United States such as TRUMAN, EISENHOWER, and KENNEDY.

*Jerome*

Date prepared

Date received

Received from (name or symbol number)

Received by

5/11/70

~~XXXXXXXXXXXXXXXXXXXX~~ Informant

SA Steven L. Christensen

Method of delivery (check appropriate blocks)

in person    by telephone    by mail    orally    recording device    written by Informant

If orally furnished and reduced to writing by Agent:

Date

Date of Report

5/3/70

Dictated \_\_\_\_\_ to \_\_\_\_\_

Date(s) of activity

Transcribed \_\_\_\_\_

Authenticated by Informant \_\_\_\_\_

5/3/70

Brief description of activity or material

File where original is located if not attached

Activities of Bill Clay \*  
Benny Godfrey

170-286A

\* INDIVIDUALS DESIGNATED BY AN ASTERISK (\*) ONLY ATTENDED A MEETING AND DID NOT ACTIVELY PARTICIPATE. VIOLENCE OR REVOLUTIONARY ACTIVITIES WERE NOT DISCUSSED.

100-14293 (Clay)  
170-286A-14  
100-14819 (Godfrey)

Block Stamp

170-286A-14

SEARCHED \_\_\_\_\_ INDEXED \_\_\_\_\_  
SERIALIZED \_\_\_\_\_  
JUN 9 1970

Christensen

MAY 3, 1970

BY JEROME

Tonight, I learned that ~~FRANK YACOBUS~~<sup>BILL CLAY</sup>  
and BARRY GODFREY were on the UCSD campus and  
put up some phoney leaflets about Demonstrator's,  
Incorporated ( a copy of which is attached), and  
some red dye was supposedly dumped on the fountain  
on Revelle College.

*Jerome*





MAY 7, 1970

BY JEROME

I have learned that BILL CLAY, BARRY GODFREY, FRANK YAKOPEC, and BONNIE NORMAN went to a rally in UCSD last night. Some Peace and Freedom Party petitions were being circulated, (attached). I learned there was an individual there, who is an Assistant District Attorney named WALLACE or WOLCOTT who was legal adviser to those present.

WARREN NEILSEN was in attendance. They had bonfire going and were smoking pot and were passing the wine and beer around. There were approximately 500-600 people present at the start, and only about 100 left at midnight, all of whom were very drunk.

*Jerome*

Date prepared

Date received

Received from (name or symbol number)

Received by

5/11/70

[REDACTED] *INFORMANT*

SA Steven L. Christensen

Method of delivery (check appropriate blocks)

in person  by telephone  by mail  orally  recording device  written by Informant

If orally furnished and reduced to writing by Agent:

Date of Report

Date

5/8/70

Dictated \_\_\_\_\_ to \_\_\_\_\_

Date(s) of activity

Transcribed \_\_\_\_\_

Authenticated by Informant \_\_\_\_\_

5/8/70

Brief description of activity or material

Info re Demonstrations  
May, 1970

File where original is located if not attached

170-286A

\* INDIVIDUALS DESIGNATED BY AN ASTERISK (\*) ONLY ATTENDED A MEETING AND DID NOT ACTIVELY PARTICIPATE. VIOLENCE OR REVOLUTIONARY ACTIVITIES WERE NOT DISCUSSED.

100-15071 - (Demonstrations (leaflets to this file on May, 1970))  
170-286A-16

~~Index~~: Freitjof Thyge  
100-15063-

- 100-13847 (SMC)
- 100-14922 (CMC)
- 100-14862 (Coats)
- 100-14995 (Stancliff)
- 100-14733 (Galley)
- 100-14660 (Tauberg)
- 100-14293 (Clay)
- ~~100~~-157-1820 (Frank Yacopiec)
- 100-14911 (People's Commune)

Block Stamp

170-286A-16

SEARCHED	INDEXED
SERIALIZED	FILED
JUN 9 1970	

*[Handwritten initials]*

ON MAY 8, 1970,

BY JEROME

Today, I went to a meeting at the Greek Bowl at State College to find out about the march route for the anti-war demonstration to be held tomorrow. There were about 60 people in attendance at the meeting which started about 3:00 PM. These included BILL COATS, ALAN STANCLIFF, FREITJOF, THYGESON, GARY GULLEY, JACKQUELYNE TUMBURG, and a reverend from the Wesleyan Foundation.

There was a big hassle about the choice of the march route; the CMC wanted to march from Horton Plaza in downtown San Diego, along Broadway to the 11th Naval District Headquarters for some speeches and then to the old ferry landing for a rally.

SMS and the other students voted this down and CMC almost walked out. A long debate followed resulting considerable uneasiness between CMC and SMC. ALAN STANCLIFF was selected as monitor captain.

Afterwards, I went with BILL CLAY to Grossmont College where another anti-war rally was taking place and picked up some leaflets, which are attached.

We noted that they were passing out free food. BILL CLAY went and got some syringes and FRANK YACOPEC bought some pickles which were injected with rubbing alcohol and castor oil and were passed out to the students who were seen eating them. It is not noted if any of them became ill.

FRANK YACOPEC set fire to a trash can in a rest-room to cause a little extra excitement. After this, we drove by the People's Commune and saw three male individuals wearing Army helmets.

*Jerome*



5/9/70  
by Jerome

Today, approximately 5,000 people, mostly long hairs and hippies participated in an anti-war march and demonstration in San Diego. They marched from the downtown area to Balboa Park where a rally was held. It was noted that MDM marched as a separate unit in the demonstration and was trying to cause trouble.

BILL CLAY, who was present recognized two "long hair" Minutemen in the middle of the MDM group trying to rabble rouse. CLAY had mobilized between 100 and 200 right wing individuals and there appeared to be a lot of right wing agitation. There also appeared to be about the same number of Marines out waiting for a fight and several were seen in front of the Federal Building holding coke bottles and waiting for the hippies to come along.

I was told that the demonstration march was stopped at the 5th Avenue Bridge over Interstate Highway 5 and that BILL CLAY and his friends were the ones who stopped it.

BILL CLAY got into a discussion with FREITJOF THYGESON, who appeared to be very disgusted with the repetitive nature of the demonstration and the location of the march.

Persons observed present at the demonstration included HERBERT MARCUSE, BILL MILSON, WARREN NIELSEN, PETER CARTWRIGHT, BILL COATS and ALAN STANCLIFF.

SYLVIA SHAPIRO was the Master of Ceremonies and STUART INNERST was the main speaker. JAN DIEPERSLOOT and RON BREEN also spoke. Dr. GEORGE ABBOTT was also there and had organized an emergency medical corps using walkie-talkies and with ambulances available.

Sergeant BILL COOK of the La Mesa Police Department, and the Captain of the Security Guards at Convair (NFI) were there and were taking good photographs of the demonstration. It was learned that BILL CLAY "liberated" two rolls

*Jerome*

of exposed film from, someone participating in the demonstration.

It was noticed that apples and oranges were being passed out and afterwards the Minutemen made plans to load up some oranges with anti-freeze and donate them to the upcoming MDM rally at Oceanside.

*perome*





MAY 22, 1970

BY JEROME

There is a new gun shop in El Cajon named the Arms Locker. It is located near the intersection of Main Street and 2nd Avenue. Both CLAY and some of the other Minutemen (MM) have been watching the place and say that a number of the leading Left Wing militants from the State College and other places around town frequent this gun shop. I was also told that JOHN BUSH is a good friend of the owner of the Arms Locker. BUSH is known to be selling guns, ammunitions and other items to Leftis and colored militants and was a leading figure in a recent student demonstration at Grossmont College, although he is not a student there.

The Arms Locker is specializing in products of the Liberty Arms Company which are mostly small automatic pistols which sell for less than \$50.

*Jerome*

Date prepared

Date received

Received from (name or symbol number)

Received by

5/27/70

INFORMANT

SA Steven L. Christensen

Method of delivery (check appropriate blocks)

in person  by telephone  by mail  orally  recording device  written by Informant

If orally furnished and reduced to writing by Agent:

Date of Report

Date

5/27/70

Dictated \_\_\_\_\_ to \_\_\_\_\_

Date(s) of activity

Transcribed \_\_\_\_\_

Authenticated by Informant \_\_\_\_\_

5/23/70

Brief description of activity or material

File where original is located if not attached

Conversation with Bill Clay - new telephone information center at UCSD

170-286A

\* INDIVIDUALS DESIGNATED BY AN ASTERISK (\*) ONLY ATTENDED A MEETING AND DID NOT ACTIVELY PARTICIPATE. VIOLENCE OR REVOLUTIONARY ACTIVITIES WERE NOT DISCUSSED.

100-14293 (Clay)

Index: American Resistance Movement; EDNA to 170-286A

~~170-286A-19~~

100-14015 (Houghton)

100-14819 (Barry Godfrey)

100-14297 (Sam Davis)

100- (George Hoover) - Open Lead

100-157-142? (Frank Yacopac)

100-157-142? (Jerry Busch)

100-14556 (Peter Ruplinger)

Block Stamp

170-286A-19

SEARCHED	INDEXED
SERIALIZED	FILED
JUN 15 1970	

*[Handwritten signature]*

MAY 27, 1970

BY JEROME

I was talking to BILL CLAY last Saturday. He seemed agitated and said he had needed to use a lot of caution. He said however, he wanted his name used and known as the local Minutemen (MM) leader and that he wanted this done to attract Federal attention in order to protect someone else in the background.

He is still talking about a new Right Wing organization and claimed to have contacts with groups in 11 western states and said these people are trying to establish a communications network and said the name American Resistance Movement (ARM) had been selected for this organization.

CLAY got to talking about DE PUGH and said he had been aware of DE PUGH's whereabouts when he was in hiding. He said he now has reason to believe TROY HOUGHTON may still be alive and probably connected with ARM. He said he believes HOUGHTON may have wanted out of the MM organization, for some reason, and had to disappear to do so.

CLAY also talked about setting up a meeting with the Leftist student group at University of California at San Diego during the regular week and he would like himself, BARRY GODFREY, SAM DAVIS, and GEORGE HOOVER to meet with four students from that group.

I have learned that HOOVER always carries a savage .380 pistol when he is away from home. DAVIS usually carries a .380 or .32 automatic pistol, CLAY usually has a .22 automatic pistol, FRANK YACOPEC always has a .32 MAB, "The Judge" (JERRY BUSH) usually has a .380 automatic pistol, and PETER RUPLINGER carries a .22 MAP.

ON MAY 26, 1970

BY JEROME

I have learned there is a new information center at UCSD, similar to Messenger Information Center. It has been in operation about two months and you reach it by dialing 453-EDNA. This information center is simply called EDNA.

*Jerome*

		Date prepared
Date received 6/3/70	Received from (name or symbol number) [Redacted] In Forthright	Received by SA Steven L. Christensen
Method of delivery (check appropriate blocks)		
<input type="checkbox"/> in person <input type="checkbox"/> by telephone <input type="checkbox"/> by mail <input checked="" type="checkbox"/> orally <input type="checkbox"/> recording device <input type="checkbox"/> written by Informant		
If orally furnished and reduced to writing by Agent: *		Date of Report
Date		6/3/70
Dictated _____ to _____		Date(s) of activity
Transcribed _____		6/3/70
Authenticated by Informant _____		File where original is located if not attached
Brief description of activity or material		170-286A
Activities of Bill Clay, Barry Godfrey & George Hoover		

\* INDIVIDUALS DESIGNATED BY AN ASTERISK (\*) ONLY ATTENDED A MEETING AND DID NOT ACTIVELY PARTICIPATE. VIOLENCE OR REVOLUTIONARY ACTIVITIES WERE NOT DISCUSSED.

- 100-14293 (Clay)
- 170-286A-20
- 100-14819 (Godfrey)
- 100- (George Hoover)
- 100-157-1938 (Alden Edward Willis)
- 100-157-1835 (Frank Yacopac)

Block Stamp

170-286A-20

SEARCHED <input checked="" type="checkbox"/>	INDEXED <input checked="" type="checkbox"/>
SERIALIZED <input checked="" type="checkbox"/>	FILED <input checked="" type="checkbox"/>
JUN 24 1970	
FBI - [Redacted]	

Christensen

6/3/70

Jerome

It has been learned that BARRY GODFREY and FRANK YACOPEC are going to see BILL CLAY this morning at about 11:00 a.m. to listen to a right wing speaker at UCSD.

This Friday GODFREY is supposed to help CLAY move to his new apartment in Pacific Beach.

The photograph of ALDEN EDWARD WILLIS is not familiar, but the one of GEORGE HOOVER is. HOOVER previously had a goatee beard, but has now shaved it off. In person he looks much meaner and heavier than he appears in the photograph. He always has the same wide-eyed expression on his face.

It has been learned that BARRY GODFREY has been picked by the San Diego Fire Department to go to a school on bombs and explosives and he will probably be on the new fire department bomb disposal squad.

*Jerome*

Date prepared

Date received

Received from (name or symbol number)

Received by

6/8/70

~~CONFIDENTIAL~~ SA Steven L. Christensen

Method of delivery (check appropriate blocks)

in person

by telephone

by mail

orally

recording device

written by Informant

If orally furnished and reduced to writing by Agent:

Date

Date of Report

Dictated \_\_\_\_\_ to \_\_\_\_\_

6/8/70

Transcribed \_\_\_\_\_

Date(s) of activity

Authenticated by Informant \_\_\_\_\_

6/5/70

Brief description of activity or material

Clay moved to new apt. - conversation w/ George Hoover.

File where original is located if not attached

170-286A

\* INDIVIDUALS DESIGNATED BY AN ASTERISK (\*) ONLY ATTENDED A MEETING AND DID NOT ACTIVELY PARTICIPATE. VIOLENCE OR REVOLUTIONARY ACTIVITIES WERE NOT DISCUSSED.

100-14293 (Bill Clay)

Index: Jerry Tartaglio;

170-286A-21

Peter Cartwright, For

100-14819 (Godfrey)

County True Press

100- (George Hoover)

to 157-1796

100-14297 (Davis)

Paper filed in 170-286A

100-157-1935 (Alden Edward Willis)

100-157-1870 (Frank Yacopac)

100-72461 (MAM)

157-1796

Block Stamp

170-286A-21

SEARCHED	INDEXED
SERIALIZED	FILED
JUN 24 1970	
[Signature]	

6/8/70  
Jerome

It has been learned that with the help of BARRY GODFREY, BILL CLAY moved last Friday, June 5, to his new apartment at 4113 Ingraham, San Diego. This is supposed to be Ingraham Villa. No one is supposed to know about this address. CLAY had a large quantity of personal belongings and junk to move and has rented a garage near Second and Ivy (between Ivy and Juniper on the east side of Second there is a row of four garages and CLAY has the second from the left) where he is storing some of this stuff.

<sup>old</sup> It was also learned that GEORGE HOOVER was at BILL CALY's ~~new~~ apartment Friday evening and was in a talkative mood as he was dead drunk. HOOVER apparently works at the same place as SAM DAVIS. HOOVER said DAVIS was recently in Texas on vacation and coming back his automobile broke down at Gila Bend, Arizona, and HOOVER had to go out there to assist him. Their boss at the fence-company, is also supposed to be a Minutemen and HOOVER and DAVIS are probably getting some of their explosives from the fence company.

HOOVER now uses a .45 Automatic Pistol which he even takes to bed with him. He claimed his boss recently put up \$400 to get him out of some legal trouble.

HOOVER Said he had been living with a girl (NFI) who in the recent past, had walked out on him and had said she was going to contact the FBI. HOOVER seemed to be worried about this.

HOOVER was getting more drunk all the time and began rambling about "the ranch" where he lives. He said he had just moved out of the hotel into one of the smaller houses on the ranch. He kept talking about his horse and asked CLAY to call "WILLIE" at the ranch and ask him to feed the horse.

*Jerome*

HOOVER uses the nickname "Mick" and usually hangs out at the "341 Club" on Second Street in El Cajon. He also kept talking about a ROGER who went with him to get SAM DAVIS. This ROGER may live or work with HOOVER.

During the evening CLAY approached HOOVER about doing something to PETER CARTWRIGHT for spilling the beans on the undercover police officer named JOHN MURRAY.

It was also learned that many Minutemen, knowing that law enforcement officers are prone to handcuff people behind their backs, are now carrying handcuff keys attached to the inside rear waist band of their pants where they can avoid being detected in a frisk.

Attached is a copy of the May issue of a new newspaper named "The Orange County True Press" which is being printed by right wingers in the Santa Ana and Anaheim area. The names of these people appear in the newspaper. The paper was acquired from JERRY TARTAGLIO through FRANK YACOPEC.

*Jerome*



Date received

Date received

6/12/70

Received from (name or symbol number)

[Redacted] Informant

Received by

SA Susan L. Christensen

Method of delivery (check appropriate blocks)

in person  by telephone  by mail  orally  recording device  written by Informant

If orally furnished and reduced to writing by Agent:

Date

Dictated \_\_\_\_\_ to \_\_\_\_\_

Transcribed \_\_\_\_\_

Authenticated by Informant \_\_\_\_\_

Date of Report

6/12/70

Date(s) of activity

6/12/70

Brief description of activity or material

Info on Bill Clay

File where original is located if not attached

170-286A

\* INDIVIDUALS DESIGNATED BY AN ASTERISK (\*) ONLY ATTENDED A MEETING AND DID NOT ACTIVELY PARTICIPATE. VIOLENCE OR REVOLUTIONARY ACTIVITIES WERE NOT DISCUSSED.

100-14293 (Clay)

170-286A-22

170-286A-22  
Block Stamp

SEARCHED \_\_\_\_\_ INDEXED \_\_\_\_\_  
SERIALIZED \_\_\_\_\_ FILED \_\_\_\_\_  
JUN 24 1970  
[Signature]

6/12/70  
JEROME

I have learned that BILL CLAY has been approached by a group of leftist students at University of California at San Diego who are allegedly fed up with the left wing tactics which have been used at University of California at San Diego and are supposed to want to form an alliance with right wing groups and individuals to deal with the Government. BILL CLAY seems to be enthusiastic about such an alliance as he feels there is a considerable amount of agreement between right and left wing groups as to the goals they would like to achieve and their general disillusionment with the Government and the established order. CLAY is giving the matter careful thought and may recontact this group of students at a future time.

*Jerome*

Date prepared

Date received: 6/19/70  
Received from (name or symbol number): ~~XXXXXXXXXXXX~~ INF 00111  
Received by: SA Steven L. Christensen

Method of delivery (check appropriate blocks)  
 in person  by telephone  by mail  orally  recording device  written by Informant

If orally furnished and reduced to writing by Agent: \*  
Date \_\_\_\_\_  
Dictated \_\_\_\_\_ to \_\_\_\_\_  
Transcribed \_\_\_\_\_  
Authenticated by Informant \_\_\_\_\_

Date of Report: 6/19/70

Date(s) of activity: 6/19/70

Brief description of activity or material  
Yippie Invasion of La Jolla

File where original is located if not attached  
170-286A

\* INDIVIDUALS DESIGNATED BY AN ASTERISK (\*) ONLY ATTENDED A MEETING AND DID NOT ACTIVELY PARTICIPATE. VIOLENCE OR REVOLUTIONARY ACTIVITIES WERE NOT DISCUSSED.

100-0-14365 (Yippie Invasion of La Jolla)  
170-286A-23

Block Stamp

170-286A-23  
SEARCHED [initials] INDEXED [initials]  
SERIALIZED [initials] FILED [initials]  
JUN 24 1970  
Christensen [initials]

6/19/70  
JEROME

An acquaintance, ARTHUR HANSEN, told me today there is a house at 711 Fern Glen, La Jolla, about two houses from HANSEN's home which is occupied by "three weirdo men" who live there together. They have many stop signs, apparently stolen from intersections around town which they have nailed to the fence in their back yard. HANSEN said he recently observed one of these men in the back yard at 711 Fern Glen wearing a housecoat and a red wig.

HANSEN also told me that the night before the "pig invasion" of La Jolla, his sleep was disturbed by loud noises at approximately 3:00 a.m. and looking out his bedroom window he saw many cars arriving in front of the house at 711 Fern Glen to the point that the street was filled up with cars. He said each car carried two to five male individuals and he estimated a total of 50 to 60 people entered the house at 711 Fern Glen. HANSEN said he watched this incident until approximately 5:00 a.m. when he went back to bed and as yet none of the individuals had left the house. He said, however, when he awoke the next day the cars appeared to be gone. HANSEN thought this incident might have had some connection with the yippie invasion of La Jolla the following day.

*Handwritten scribble*



7/2/70  
JEROME

Attached are three letters and envelopes which recently came to my attention. These letters are allegedly responses to an ad that appeared in the Free Door To Liberation for anyone interested in forming a local Weatherman group. These letters were supposedly obtained from the Free Door by the Minutemen and will have to be returned.

*Jerome*

I've been an SDS organizer  
in Washington state and am  
interested in finding a real  
SDS chapter here. If you guys  
are a bunch dogmatic Leninists  
don't bother to write back.  
What colleges are you from?  
What are your political  
goals? No revolutionary class  
"street fighting". Only when it  
is necessary - why do you  
advertise for it? Do you  
really go which way the wind  
blowing? Like I said if  
you're really an SDS  
give me a reply.  
Jerome

SDS  
704 11 7  
2121 11 7  
S.D. 11 7

2221 Abbott St.  
San Diego, 92107

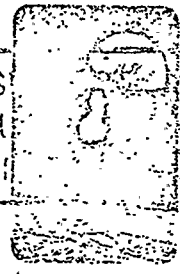

8c  
U.S. AIR MAIL  
8c  
U.S. AIR MAIL  
8c  
U.S. AIR MAIL

SDS  
Free-Down Box 504  
6389 Imperial Ave.  
San Diego, CA  
92114



To Whom It May Concern

I saw your article in the Free Door  
and I am writing to inquire about  
more information. Please send it to  
3959 Texax, San Diego, Calif, any information  
you can give me will be greatly appreciated.

Thank You  
Maurice F. Cleary Jr.

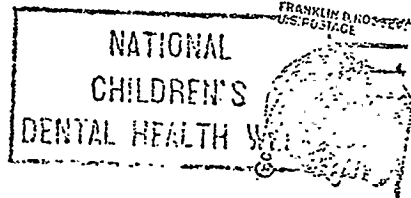

Free Door  
Box 504  
San Diego, Calif

92114

Jerome

To whom it may concern  
I just came down to San Diego  
after being sent to Patton State  
Hospital for 9 months on false  
charges concocted by certain people  
from the establishment.

I would like you to send me  
some information on SDS.

Here's my address:

Robert J Sullivan  
Apt. 29  
7930 El Cajon Blvd.  
La Mesa, Calif. 92041

AFTER 5 DAYS RETURN TO

Robert Sullivan  
7930 El Cajon Blvd.  
La Mesa, Calif. 92041  
ZIP CODE

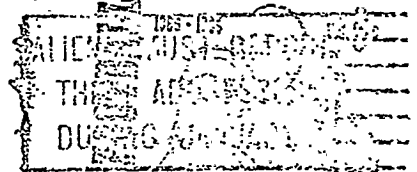

Weathermen SDS  
Tree Door  
P.O. Box 504  
San Diego, Calif.

12/14

Jerome

Date prepared

7/13/70

Date received

7/8/70

Received from (name or symbol number)

[redacted] INFORMANT

Received by

SA Steven L. Christensen

Method of delivery (check appropriate blocks)

in person  by telephone  by mail  orally  recording device  written by Informant

If orally furnished and reduced to writing by Agent: \*

Date

Date of Report

7/8/70

Dictated \_\_\_\_\_ to \_\_\_\_\_

Date(s) of activity

7/6/70

Transcribed \_\_\_\_\_

Authenticated by Informant \_\_\_\_\_

Brief description of activity or material

Info re Jerry Geyer & Sandra Davis

File where original is located if not attached

170-286A

\* INDIVIDUALS DESIGNATED BY AN ASTERISK (\*) ONLY ATTENDED A MEETING AND DID NOT ACTIVELY PARTICIPATE. VIOLENCE OR REVOLUTIONARY ACTIVITIES WERE NOT DISCUSSED.

100- (Jerry Geyer)  
170-286A - Davis  
100-14297 (Davis)

Block Stamp

170-286A-25

SEARCHED INDEXED  
SERIALIZED FILED  
JUL 17 1970

REPORT BY JEROME  
On July 8, 1970.

I was at JERRY GEYER's house on the evening of July 6, 1970. GEYER said he was given some gun parts by a person named "DOC" who is an ex-serviceman and a friend of LYLE MANNING. GEYER said according to DOC, these parts belonged to SAM DAVIS and SAM was suppose to get in touch with him later about the parts. The parts are for a World War II German automatic assault rifle and are illegal to own. GEYER said following this a person who gave his name as SAM WILLIAMS called on the telephone and asked about some other gun parts. GEYER recognized the voice, however as being that of SAM DAVIS and GEYER is now suspicious of DAVIS because he does not know what he is up to. He said DAVIS was looking around for 50 M-2 Trip Levers.

It has been rumored DAVIS is paying high prices for guns and gun parts but is selling low to TOM FORREST. FORREST is the biggest gun dealer in town.

*Jerome*

Date prepared

8/13/70

Date received

8/7/70

Received from (name or symbol number)

~~XXXXXXXXXXXXXXXXXXXX~~ INFORMANT

Received by

SA Steven L. Christensen

Method of delivery (check appropriate blocks)

in person  by telephone  by mail  orally  recording device  written by Informant

If orally furnished and reduced to writing by Agent:

Date

Date of Report

8/8/70

Dictated \_\_\_\_\_ to \_\_\_\_\_

Date(s) of activity

Transcribed \_\_\_\_\_

8/6/70

Authenticated by Informant \_\_\_\_\_

Brief description of activity or material

National Gippie Day at  
Disneyland

File where original is located if not attached

170-286A

\* INDIVIDUALS DESIGNATED BY AN ASTERISK (\*) ONLY ATTENDED A MEETING AND DID NOT ACTIVELY PARTICIPATE. VIOLENCE OR REVOLUTIONARY ACTIVITIES WERE NOT DISCUSSED.

100-1522-1 (National Gippie Day at  
Disneyland, 8/6/70)

170-286A - info

100-152 (1962) (Frank Vaccaro)

Block Stamp

170-286A-26

SEARCHED  INDEXED   
SERIALIZED   
AUG 14 1970  
FBI

REPORT BY JEROME  
On August 7, 1970

Yesterday, August 6, 1970, I went to watch the National Yippie Day at Disneyland. Many long hairs and hippie type people were at the gate and parking lot all day long but there were never enough there at one time to make a big crowd and most left after milling around for a while. It appeared that they just did not have enough money to get in.

FRANK YACOPEC, JERRY TARTAGLIO and others got in using Press Cards from the Anaheim Bulletin. Also there was EUGENE BROWN from the Orange County True Press, STEVE FRANKS from VIVA and many other right wingers from the Orange County area. The group took several hundred photographs and shot two rolls of movie films.

The only serious incident occurred at about 6:30 p.m., when 300 or 400 yippies got together and started marching from place to place in Disneyland. There were several scuffles with the police who were called in at about 7:00 p.m., and one girl was yelling "Kill the Pig, Kill the Pig."

The yippies made an attempt to tear down the flag in the fort but JERRY TARTAGLIO and "CHUCK" stood against the flag pole and stopped them.

One of the apparent leaders of the yippies was about 45 years old with long hair and beads. He got into a scuffle with the police and a cop grabbed him by the hair, which came right off showing him to be very bald.

It looked to me as if there would have been serious trouble if the yippies had been able to get a few more people in there. However, they backed right down when they were confronted by the police. A lot of threats were made and obscenity used.

During the day I noted about six yippies in front of the gate with 15 - 20 ticket books passing out tickets to other yippies to get in. Someone put out a lot of money for a lot of yippies to get in.

*Jerome*

After the yippies were thrown out, there was some rock throwing at the gate and an attempted march on the Disneyland Hotel which the police broke up. It was later announced that people with long hair would no longer be allowed admittance into Disneyland.

*Jerome*

Date prepared

8/10/70

Date received

8/10/70

Received from (name or symbol number)

INFORMANT

Received by

SA Steven H. Christensen

Method of delivery (check appropriate blocks)

in person  by telephone  by mail  orally  recording device  written by Informant

Orally furnished and reduced to writing by Agent:

Date

Dictated \_\_\_\_\_ to \_\_\_\_\_

Transcribed \_\_\_\_\_

Authenticated by Informant \_\_\_\_\_

Brief description of activity or material

Info re. Peter Ruppinger, Leon Nover  
MM Org. Bill Clay

Date of Report

8/10/70

Date(s) of activity

8/9/70

File where original is located if not attached

170-286A

INDIVIDUALS DESIGNATED BY AN ASTERISK (\*) ONLY ATTENDED A MEETING AND DID NOT ACTIVELY PARTICIPATE. VIOLENCE OR REVOLUTIONARY ACTIVITIES WERE NOT DISCUSSED.

- 100-14551 (Peter Ruppinger)
- 100-286A-21
- 157-594 (Nover)
- 100-14541 (American Volunteer Group)
- 100-157-1521 (Frank Yacopiec)
- 100-14293 (Bill Clay)
- 100-14819 (Barry Godfrey)
- 100-13674 (John Westwood)
- 100-15133 (Jerry Tarringer)

- Index: (To AVG) <sup>Laurence Horton</sup> Orange County  
True Press; John Zennaro  
Lloyd Pullen; STAFF  
Glen Jackson; <sup>STAFF</sup>  
Fantagio; Eugene  
Branch; VIVA  
(To Peter Ruppinger)  
Fred Akers - <sup>INFORMANT</sup>

Block Stamp

170-286A-27

SEARCHED	INDEXED
SERIALIZED	FILED
AUG 14 1970	

(Signature)



REPORT BY JEROME  
On August 10, 1970

Would identify ANOTHER INFORMANT

There is much antagonism between the right wing group in San Diego and Los Angeles. The Orange County True Press has ~~disintegrated~~ <sup>disintegrated</sup>. Some of the Los Angeles groups are trying to dis-credit FRANK YACOPEC, who was working on the paper and have made JERRY TARTAGLIO mad at him. It looks like JOHN ZEMANEC of AVG and LLOYD PULLEN of SEAF are trying to move in on the Orange County True Press. Those two and GLEN JACKSON of the National Patriotic Party and LAWRENCE NORTON connected with the Minute-men and AVG were at a meeting with JERRY TARTAGLIO at two o'clock in the morning last week and apparently want to stop all right wing activity in San Diego.

I was told that EUGENE BROWN, editor of the Orange County True Press and TARTAGLIO have been trying to get FRANK YACOPEC and BARRY GODFREY's address in San Diego.

VIVA is a front group for ED BUTLER who puts out the Orange County True Press. Attached are copies of the June and July 1970 issues of the paper.

I was talking to BILL CLAY this morning about the situation and he suggested trying to push the San Diego Minute-men organization in Orange County. He was talking about setting up a mail drop in Yuma or Phoenix, Arizona.

*Jerome*

PETER RUPLINGER is presently living with Professor FRED AKERS at 5137 Rincon Street, San Diego, California. He has made contact with an organization of right wing professors at San Diego State College who have gotten together to try and do something about the situation on college campuses. He thinks there may be a similar group at the University of California at San Diego.

*Jerome*



REPORT BY JEROME  
On August 17, 1970

I stopped and watched the White Whale for about a half of an hour last night at 9:00 p.m. The benefit for the San Diego Street Journal was in full swing and I saw 30 ± 40' long hair hippie types outside. Someone apparently turned in a false fire alarm at the White Whale as three fire trucks and several police cars came screaming up. After that there were a lot of people milling around the White Whale and I had to leave. FRANK YACOPEC was also there watching.

— Would Identify Possible Source

Date prepared

9/1/70

Date received

8/25/70

Received from (name or symbol number)

[REDACTED] INFORMANT

Received by

SA Steven H. Christensen

Method of delivery (check appropriate blocks)

in person

by telephone

by mail

orally

recording device

written by Informant

If orally-furnished and reduced to writing by Agent:  
Date

Dictated \_\_\_\_\_ to \_\_\_\_\_

Transcribed \_\_\_\_\_

Authenticated by Informant \_\_\_\_\_

Date of Report

8/25/70

Date(s) of activity

8/25/70

Brief description of activity or material

Info re Region of Justice

File where original is located if not attached

170-286A

\* INDIVIDUALS DESIGNATED BY AN ASTERISK (\*) ONLY ATTENDED A MEETING AND DID NOT ACTIVELY PARTICIPATE. VIOLENCE OR REVOLUTIONARY ACTIVITIES WERE NOT DISCUSSED.

Information recorded on a card index by \_\_\_\_\_ on date \_\_\_\_\_

Remarks:

~~100~~ 176-1-5 (Region of Justice) 176-655

170-286A-29

100-14293 (Clay)

170-286A-29  
Block Stamp

SEARCHED  INDEXED   
SERIALIZED   
SEP 3 1970

REPORT BY JEROME  
August 25, 1970

The name Legion of Justice is not familiar to me and neither are the names of BUCKMAN, STEWART, or ARTHUR who are suppose to be connected with it. BILL CLAY does have a Post Office Box in his name at La Mesa and he may possibly be BUCKMAN. CLAY said at one time that some strange mail might show up in the La Mesa Post Office Box and if so to save it for him.

To the best of my knowledge, Mr. BUCKMAN who runs Buckman's Gun Shop on University is a nice old fellow but may have some right wing leanings. He has a son who runs an appliance store near the Gun Shop who is definitely right wing and very wild.

*Jerome*



REPORT BY JEROME  
August 24, 1970

Worlds Identity Another Informant

The Minute-men at San Diego have put out a bunch of new stickers (one is attached). The La Mesa Post Office Box number on the sticker is listed to BILL CLAY, with whom I talked on Friday. He said that he does not want to be contacted by right wingers in the San Diego area, except in an emergency because he does not want to be connected with the new stickers. He thinks the FBI will be around to see him about the stickers anyway.

I do not know what CLAY is up to. It may be he is trying to separate himself from local right wing activities or possibly he is trying to decoy attention away from people involved in local Minute-men activities. I still get the feeling CLAY is involved in something big and is trying to get some organization going in several states.

I also stopped off at JERRY GEYER's house Friday evening and saw a big tripod mounted World War II German machine gun. He also had all of the grease gun parts laying around and had a case of a dozen timing devices for artillery shells.

*Jerome*





"MINUTEMEN"

WRITE AFC  
P. O. 3366  
LA MESA CALIF.

Date prepared

8/13/70

Date received

8/10/70

Received from (name or symbol number)

INFORMANT

Received by

SA Steven L. Christensen

Method of delivery (check appropriate blocks)

in person  by telephone  by mail  orally  recording device  written by Informant

If orally furnished and reduced to writing by Agent: Date

Dictated \_\_\_\_\_ to \_\_\_\_\_

Transcribed \_\_\_\_\_

Authenticated by Informant \_\_\_\_\_

Date of Report

8/10/70

Date(s) of activity

8/9/70

Brief description of activity or material

Info re Peter Ruppinger, Leon Newer  
MM Org., Bill Clay

File where original is located if not attached

170-286A

\* INDIVIDUALS DESIGNATED BY AN ASTERISK (\*) ONLY ATTENDED A MEETING AND DID NOT ACTIVELY PARTICIPATE. VIOLENCE OR REVOLUTIONARY ACTIVITIES WERE NOT DISCUSSED.

- 100-14351 (Peter Ruppinger)
- 170-286A-21
- 157-594 (Newer)
- 100-14541 (American Volunteer Group)
- 100-157-1520 (Frank Vaccoppe)
- 100-14293 (Bill Clay)
- 100-14819 (Barry Godfrey)
- 100-13674 (John Westwood)
- 100-15133 (Jerry Taylor)

- Index: (To AVG) Lawrence Horton
- Orange County True Press; John Zernack
- Lloyd Pullen; STAFF
- Glen Jackson; Jerry
- Fantagio; Eugene
- Brown; VIVA
- (To Peter Ruppinger)
- Fred Akers - INFORMANT

Block Stamp

170-286A-27

SEARCHED	INDEXED
SERIALIZED	FILED
AUG 14 1970	

Christensen

REPORT BY JEROME  
On August 10, 1970

WOULD IDENTIFY ANOTHER INTERMANT

There is much antagonism between the right wing group in San Diego and Los Angeles. The Orange County True Press has ~~disintegrated~~ <sup>disintegrated</sup>. Some of the Los Angeles groups are trying to dis-credit FRANK YACOPEC, who was working on the paper and have made JERRY TARTAGLIO mad at him. It looks like JOHN ZEMANEC of AVG and LLOYD PULLEN of STAFF are trying to move in on the Orange County True Press. Those two and GLEN JACKSON of the National Patriotic Party and LAWRENCE NORTON connected with the Minute-men and AVG were at a meeting with JERRY TARTAGLIO at two o'clock in the morning last week and apparently want to stop all right wing activity in San Diego.

I was told that EUGENE BROWN, editor of the Orange County True Press and TARTAGLIO have been trying to get FRANK YACOPEC and BARRY GODFREY's address in San Diego.

VIVA is a front group for ED BUTLER who puts out the Orange County True Press. Attached are copies of the June and July 1970 issues of the paper.

I was talking to BILL CLAY this morning about the situation and he suggested trying to push the San Diego Minute-men organization in Orange County. He was talking about setting up a mail drop in Yuma or Phoenix, Arizona.

*Jerome*

PETER RUPLINGER is presently living with Professor FRED AKERS at 5137 Rincon Street, San Diego, California. He has made contact with an organization of right wing professors at San Diego State College who have gotten together to try and do something about the situation on college campuses. He thinks there may be a similar group at the University of California at San Diego.

*Jerome*

UNITED STATES GOVERNMENT

# Memorandum

TO : SAC, SAN DIEGO

DATE: 9/3/70

FROM : SA C. JORDAN NAYLOR (170-286)

SUBJECT: ~~CONFIDENTIAL~~ **INFORMANT**

At 8:30 a.m. on 9/3/70, informant advised he had received the following information relative to President NIXON's visit to Coronado on this date:

LILA BUCK and a group of approximately 50 "right-wingers" have organized themselves and plan to meet on the corner of 12th Street and Orange Street, Coronado, between 9:00 and 10:00 a.m., 9/3/70, to attract attention regarding their protest because President NIXON has refused to see Reverend MC INTYRE (phonetic). Specific plans of the group are unknown except for the fact they plan to attract the President's attention to the Reverend MC INTYRE matter. Further details unknown.

The Message Information Center, telephone number 232-6621, has been encouraging all "left wingers" to meet in front of the Del Coronado Hotel between 9:00 and 11:00 a.m. on 9/3/70. A cadre has been organized to walk through the crowd to attempt to stir up trouble. This is to occur in connection with the "yippie dope-in," which is to occur during the day.

Informant said he will be attending activities at Coronado during the day and will immediately contact Agent NAYLOR or Agent CHRISTENSEN to furnish details of any demonstrations which come to his attention.

- ① - 170-286 A
- 1 - 100-15317
- 1 - 105-7373

CJN:mt  
(3)

*Agent Christensen  
9/3/70*

31

170-286A-~~31~~

SEARCHED	INDEXED
SERIALIZED	FILED
FBI - SAN DIEGO	

*5/6*

Date prepared

9/2/70

Date received

8/27/70

Received from (name or symbol number)

~~CONFIDENTIAL~~ INF

Received by

SA Stuart Christensen

Method of delivery (check appropriate blocks)

in person  by telephone  by mail  orally  recording device  written by Informant

If orally furnished and reduced to writing by Agent:

Date

Date of Report

8/27/70

Dictated \_\_\_\_\_ to \_\_\_\_\_

Transcribed \_\_\_\_\_

Authenticated by Informant \_\_\_\_\_

Date(s) of activity

8/27/70

Brief description of activity or material

Info re AVG

File where original is located if not attached

170-286A

\* INDIVIDUALS DESIGNATED BY AN ASTERISK (\*) ONLY ATTENDED A MEETING AND DID NOT ACTIVELY PARTICIPATE. VIOLENCE OR REVOLUTIONARY ACTIVITIES WERE NOT DISCUSSED.

Information recorded on a card index by \_\_\_\_\_ on date \_\_\_\_\_

Remarks:

100-14541 (American Volunteer Group)

170-286A-32

100-14301 (Paul Ruplinger)

100-14293 (Clay)

~~100-142167~~ (AM)

157-1798

Index: William Lemke  
Medric "Bud" Johnson  
John Zemanec  
Helen Grant  
Frank Capelo  
to AVG

Block Stamp

170-286A-32  
SEARCHED [ ] INDEXED [ ]  
SERIALIZED [ ]  
SEP 3 1970  
FBI - [ ]  
Chick [ ]

REPORT BY JEROME  
August 27, 1970

This morning I was talking to General WILLIAM LEMLY who lives at 1536 Glorietta Place, Coronado. He claimed to have been part of a Military underground organization since 1927, which was strong because of fears in the Military of Communist takeover in this country.

He told me that AVG actually stands for American Volunteer Government. He explained that later on the organization felt a need for an above-ground front organization and so established the American Volunteer Group, with MEDRIC "BUD" JOHNSON as the leader and with an Advisory Council of 13 Military officers. These included Commander BALDORF who refused to go to Vietnam because the Government would not fight to win, General "CHESTY" PULLER, General CUSTIS LE MAY, and others.

According to LEMLY, membership in American Volunteer Groups was to be opened to civilians but - restricted only to those referred to the organization by the Military Council and those who were already members.

When "BUD" JOHNSON died, under mysterious circumstances, JOHN ZEMANEC and his secretary, HELEN GRANT, took over. ZEMANEC and GRANT then threw the membership open to the general public upon which the Military Council dropped out, and as far as the Military is concerned, that part of AVG is now defunct.

LEMLY told me that the name A. DUNN which appears on old AVG bulletins and letterhead stationery is a pseudonym for a woman from Seattle. He said she is an agent for a private investigative group which has its headquarters on the east coast. This investigative group is run by a former FBI Agent named FRANK CAPELO (phonetic) and investigates left wing activities.

CAPELO is suppose to be in the San Diego area in the near future, and LEMLY said he would refer me to him for possible employment as an Agent on the west coast.

*Jerome*

LEMPLY claimed that he and ROBERT WELSH, leader of the John Birch Society are good friends and communicate frequently. LEMPLY claimed that he is Vice-President of the National Liberty Amendment Committee, which is a front group for the John Birch Society. The Liberty Amendment represents the elimination of income tax and LEMPLY claimed he was testifying last week before a California State Senate Group about the amendment.

I saw LEMPLY on PAUL RUPLINGER's recommendation. LEMPLY claimed he and PAUL RUPLINGER are also good friends. LEMPLY again talked about the American Volunteer Government and said the purpose of the organization is to bring about a Military coup in this country if it becomes necessary. He said the organization's headquarters are located in or near Washington, D.C.

LEMPLY said that JOHN ZEMANEC was formerly Chief of Security of the above ground organization under JOHNSON and his secretary, HELEN GRANT, was suppose to be a teacher but LEMPLY's group was never able to verify this. LEMPLY said that because of the peculiar circumstances surrounding JOHNSON's death, his group did a little investigating and found that ZEMANEC was a Long Shorman and belonged to HARRY BRIDGES Long Shorman Union. LEMPLY said that ZEMANEC might actually have been a left wing infiltrator.

LEMPLY appeared to be very Military, anti-left and pro-minute-men and may form an alliance with the Minute-men in this area.

LEMPLY who was in ONI for several years, also claimed to have access to Canadian and British Intelligence Reports from all over the world, through a friend who is still in Washington, D.C.

After talking to LEMPLY, I saw BILL CLAY who told me that he is now working in some big national movement and can no longer spare the time to be deeply involved in local Minute-men activities.

*Jerome*



CLAY passed on to me all of the stuff he had been using including blank Birth and Marriage Certificates, Selective Service Registration cards, Social Security Application forms, Letterhead Stationery from many companies around the country, FBI Letterhead Stationery, forms to fill out showing receipt of Marine Corps Good Conduct Medals. He also gave me a plate burner for making stencils for an off set press.

CLAY said he would continue to give local Minute-men any help and support necessary both here and in other places and said he would set up a Post Office Box in Las Vegas for the local Minute-Men group.

*Jerome*

Date prepared

9/8/70

Date received

8/31/70

Received from (name or symbol number)

~~XXXXXXXXXX~~ INFORMANT

Received by

SA Steven L. Christensen

Method of delivery (check appropriate blocks)

in person  by telephone  by mail  orally  recording device  written by Informant

If orally furnished and reduced to writing by Agent:  
Date

Date of Report

8/31/70

Dictated \_\_\_\_\_ to \_\_\_\_\_

Date(s) of activity

8/31/70

Transcribed \_\_\_\_\_

Authenticated by Informant \_\_\_\_\_

Brief description of activity or material

Info re Free Door, Sunrise + AVG

File where original is located if not attached

170-286 A

\* INDIVIDUALS DESIGNATED BY AN ASTERISK (\*) ONLY ATTENDED A MEETING AND DID NOT ACTIVELY PARTICIPATE. VIOLENCE OR REVOLUTIONARY ACTIVITIES WERE NOT DISCUSSED.

Information recorded on a card index by \_\_\_\_\_ on date \_\_\_\_\_

Remarks:

100-14948 (Free Door)

170-286A-33

100-15712 (Sunrise)

100-14541 (AVG)

~~100-12401~~ (MM)

157-1798

Index: (To AVG) General William Lemley; John Ozemanec

Block Stamp

170-286A-33

SEARCHED	INDEXED
SERIALIZED	
SEP 14 1970	
FBI - [unclear]	

*[Signature]*

REPORT BY JEROME  
August 31, 1970

I found out this morning in talking with DALE HERSCHLER that the manager of Les Girls who was supporting the Free Door financially backed out two weeks ago and the paper is now in trouble. For the first time the Door is planning to charge for the newspaper, they still may not have enough money to print it. They have decided to stop carrying sex oriented adds in the paper.

I also learned that the Sunrise newspaper lost at least \$8,000 on the rock concert it sponsored and does not have enough money to go on printing.

I talked to General LEMLY of AVG again who told me that "BUD" JOHNSON, former leader of AVG, was in the process of putting together a big expose on the Communist Party in the United States at the time of his death. LEMLY said JOHNSON was getting his information from a former Military Intelligence Officer who was also connected with AVG. LEMLY said he and other officers in the Military part of AVG suspect JOHN ZEMANEC may have had JOHNSON done in and the Military part of AVG is out to get ZEMANEC and the civilian AVG organization if they can.

LEMLY claimed he and some right wing friends were responsible for putting together and passing out the leaflets announcing the Yippie Pig National Invasion of La Jolla early in the summer. LEMLY said although they did not think anything would actually happen, it turned out better than expected as many La Jollans were turned against the left and have indicated support for right wing activities.

The new Minute-men stickers were printed at Alex Rapid Print in La Mesa, California.

*Jerome*

Date prepared

9/8/70

Date received

9/2/70

Received from (name or symbol number)

~~XXXXXXXXXX~~ / I, Informant

Received by

SA Steven L. Christensen

Method of delivery (check appropriate blocks)

in person  by telephone  by mail  orally  recording device  written by Informant

If orally furnished and reduced to writing by Agent:

Date

Dictated \_\_\_\_\_ to \_\_\_\_\_

Transcribed \_\_\_\_\_

Authenticated by Informant \_\_\_\_\_

Date of Report

9/2/70

Date(s) of activity

9/2/70

Brief description of activity or material

Info re MIC & President  
Nixon visit 9/3/70

File where original is located if not attached

170-286A

\* INDIVIDUALS DESIGNATED BY AN ASTERISK (\*) ONLY ATTENDED A MEETING AND DID NOT ACTIVELY PARTICIPATE. VIOLENCE OR REVOLUTIONARY ACTIVITIES WERE NOT DISCUSSED.

Information recorded on a card index by \_\_\_\_\_ on date \_\_\_\_\_

Remarks:

100-14427 (MIC)  
170-286A-34  
100-15317 (Nixon Visit)  
100-17079 (John Birch Society)

Block Stamp

170-286A-34

SEARCHED	INDEXED
SERIALIZED	FILED
SEP 14 1970	
FBI - MEMPHIS	

Christensen

REPORT BY JEROME  
September 2, 1970

I learned this afternoon from Message Information Center that an unidentified group of individuals in the San Diego area is preparing for a large scale anti-Vietnam war demonstration tomorrow during the festivities surrounding the visit and State dinner of Presidents NIXON and ORDAZ. Apparently this demonstration is separate and apart from the previously announced "Yippie Dope-In" at Coronado, California, tomorrow.

According to MIC plans for the demonstration call for participants to gather in the Hotel Del Coronado parking lot for a rally and march beginning at 9:00 A.M.

I have also learned that a large number of right wing oriented individuals mostly older female members of the John Birch Society will also be present in Coronado tomorrow to carry signs and protest against left wing groups.

Date prepared

9/14/70

Date received

9/4/70

Received from (name or symbol number)

~~XXXXXXXXXX~~ ] INFORMANT

Received by

SA Steven L. Christensen

Method of delivery (check appropriate blocks)

in person  by telephone  by mail  orally  recording device  written by Informant

If orally furnished and reduced to writing by Agent:

Date

Date of Report

9/4/70

Dictated \_\_\_\_\_ to \_\_\_\_\_

Date(s) of activity

Transcribed \_\_\_\_\_

9/3/70

Authenticated by Informant \_\_\_\_\_

Brief description of activity or material

info re visit of Pres. Nixon to Colorado

File where original is located if not attached

190-286A

\* INDIVIDUALS DESIGNATED BY AN ASTERISK (\*) ONLY ATTENDED A MEETING AND DID NOT ACTIVELY PARTICIPATE. VIOLENCE OR REVOLUTIONARY ACTIVITIES WERE NOT DISCUSSED.

Information recorded on a card index by \_\_\_\_\_ on date \_\_\_\_\_

Remarks:

100-15317 (Nixon Visit) Index: Cal. Lib. KMY 364,  
170-286A-35 Bonnie Anderson  
100-14356 (Peter Kaufinger)  
100-14075 (Lowell Bergman)  
157-800 (Dale Henschler)  
100-14376 (St. Journal)

170-286A-35 Block Stamp

SEARCHED 12 INDEXED  
SERIALIZED 13  
SEP 15 1970  
FBI - MEMPHIS  
[Signature]

REPORT BY JEROME  
On September 4, 1970

I went over to Coronado yesterday to watch the parade in honor of President NIXON and President ORDAZ and while there I noticed six suspicious male individuals, three colored, two white and one Mexican. They were roaming through the crowds trying to agitate and stir people up. I followed them to the Del Coronado Hotel. They finally got into a Pontiac with California license KMY 364 and I saw one or two rifles in the car. I immediately contacted a California Highway Patrol Officer who put this information out on his car radio.

According to PETER RUPLINGER, who was with me, he previously observed one of these Negro males acting as Master of Ceremonies when ABBY HOFFMAN appeared at San Diego State College to speak several months ago.

I observed the following persons at the parade:

BONNIE ANDERSON, a white girl who is believed to be connected with the Progressive Labor Party.

Several unidentified leaders of the Chicano Moratorium March at Los Angeles who were asking for contributions for bail for the Chicanos arrested in Los Angeles.

DALE HERSCHLER, former editor of the Door.

LOWELL BERGMAN of the San Diego Street Journal.

The orange bus which the Street Journal used last year was also there.

A number of right wingers, 19 - 20, mostly older women carrying signs which said "March for victory at Washington, C.D., on October 3, 1970".

*Jerome*

Date prepared

9/14/70

Date received

9/8/70

Received from (name or symbol number)

~~CONFIDENTIAL~~ [redacted]

Received by

SA Steven L. Christensen

Method of delivery (check appropriate blocks)

in person  by telephone  by mail  orally  recording device  written by Informant

If orally furnished and reduced to writing by Agent:

Date

Dictated \_\_\_\_\_ to \_\_\_\_\_

Date of Report

9/8/70

Date(s) of activity

9/8/70

Transcribed \_\_\_\_\_

Authenticated by Informant 10/

Brief description of activity or material

Info re activities of Peter & Paul Ruppinger

File where original is located if not attached

170-286A

\* INDIVIDUALS DESIGNATED BY AN ASTERISK (\*) ONLY ATTENDED A MEETING AND DID NOT ACTIVELY PARTICIPATE. VIOLENCE OR REVOLUTIONARY ACTIVITIES WERE NOT DISCUSSED.

Information recorded on a card index by \_\_\_\_\_ on date \_\_\_\_\_

Remarks:

100-14350 (Peter Ruppinger)  
170-286A - 36  
~~100-151 1870~~ (Frank Yacofec)  
100-14819 (Barry Godfrey)  
100-14301 (Paul Ruppinger)  
100-11836 (YSA)

Index: Don Freedman  
Travis Jackson  
R. J. Work

Block Stamp

170-286A-36  
SEARCHED [initials] INDEXED [initials]  
SERIALIZED [initials]  
SEP 15 1970  
Christensen



REPORT BY JEROME  
On September 8, 1970

I was talking to PETER RUPLINGER this morning and he told me about DEPUGH holding some of the people in cages when he was captured by the FBI.

PETER is no longer living with Professor FRED AKERS and has temporarily rented an apartment in El Cajon using the name DON FREEDMAN. He is going to try to rent one or two Post Office Boxes using that name.

PETER is suppose to get married October 23, 1970, and will then rent an apartment in his own name.

PETER told me that he, FRANK YACOPEC and BARRY GODFREY had a meeting to make out future right wing strategy. It was decided that they would continue to harassing left wing individual and organizations but would avoid hurting anyone or getting involved in any real violence. PETER said that he made contact with a person named "TRAVIS" who he said is a lefty but who he is converting. PETER said TRAVIS told him on September 3, 1970, about a person named R. J. WORK, who lives on Lincoln Avenue who had infiltrated activities for the left.

He also told me about an individual at the University of California at San Diego where a construction worker dropped a five gallon bucket of tar from the fifth floor of the new hospital building into a group of hippies. Apparently the bucket of tar broke and sprayed all over the hippies.

PAUL

~~PETER~~ RUPLINGER, posing as a prospective buyer, went to the house at 1362 Union Street, San Diego, California, on September 2, 1970. He said he found the place was divided into four apartments, some of which he did not see. He said he observed nothing which might possibly have been connected with YSA and added that the landlady told him she had just told the tenants to get out of one of the apartments and had re-rented it.

TRAVIS IS TRAVIS JACKSON

Jerome



REPORT BY JEROME  
September 9, 1970

I saw BILL CLAY this morning and received from him negatives and other material for making phony draft cards, Selective Service Cards, California State Birth Certificates, Missouri and California Drivers Licenses and many other papers for making phony identifications.

CLAY again said he is trying to do some work on a nation wide movement.

The Minutemen are very interested in finding out if Mecha-Maya and the black students council at San Diego State College are still to get the proceeds from the first to home football games which San Diego State College plays.

CLAY also asked me to get a new Post Office Box for him which I agreed to do and I will furnish the combination and number as soon as I get it.

*Jerome*

Date recorded

9/23/70

Date received

9/17/70

Received from (name or symbol number)

[REDACTED] INFORMANT

Received by

SA Steven L. Christensen

Method of delivery (check appropriate blocks)

in person  by telephone  by mail  orally  recording device  written by Informant

If orally furnished and reduced to writing by Agent:

Date

Dictated \_\_\_\_\_ to \_\_\_\_\_

Transcribed \_\_\_\_\_

Authenticated by Informant 10/9/70

Date of Report

9/17/70

Date(s) of activity

9/17/70

Brief description of activity or material

Info re MIC

File where original is located if not attached

170-286A

\* INDIVIDUALS DESIGNATED BY AN ASTERISK (\*) ONLY ATTENDED A MEETING AND DID NOT ACTIVELY PARTICIPATE. VIOLENCE OR REVOLUTIONARY ACTIVITIES WERE NOT DISCUSSED.

Information recorded on a card index by \_\_\_\_\_ on date \_\_\_\_\_

Remarks:

100-14427 (MIC)

170-286A-38

157-594 (Nover)

100-14892 (MDM)

100 - dead (Phil Plymate)

100 - (New Adult Community) m.a.s. info  
- dead if no file

Block Stamp 170-286A-38

SEARCHED 7 INDEXED  
SERIALIZED 7  
SEP 25 1970  
Steven L. Christensen

REPORT BY JEROME  
September 17, 1970

I have learned that Message Information Center has a comline or telephone extension to New ~~Educational~~ *Adult* Community at 1924 Island. MIC has a three digit rotary switch board and gets an extremely large number of calls every day.

The head operator and the person who apparently runs MIC is named PHIL PLYMATE. However, it looks to me as though MIC is completely controled and directed by New Educational Community.

I have learned that the keys to the MIC Office are kept at 1924 Island. MIC is in operation every day from 9:00 A.M., till midnight.

Last night I tried to call LEON NOWER at his home at about 11:00 P.M.; a babysitter answered the phone and said he was not home, but in an emergency could be reached at 443-5869, or at 442-2163.

While I was at MIC today I learned that MDM had a new telephone installed today which is 234-1190, and which is supposed to be kept confidential

*Jerome*

Date prepared

9/23/70

Date received

9/18/70

Received from (name or symbol number)

~~INFORMANT~~

Received by

SA Steven L. Christensen

Method of delivery (check appropriate blocks)

in person  by telephone  by mail  orally  recording device  written by Informant

If orally furnished and reduced to writing by Agent:

Date

Date of Report

9/18/70

Dictated \_\_\_\_\_ to \_\_\_\_\_

Transcribed \_\_\_\_\_

Authenticated by Informant \_\_\_\_\_

Date(s) of activity

9/18/70

Brief description of activity or material

Info re MIC

File where original is located if not attached

170-286A

\* INDIVIDUALS DESIGNATED BY AN ASTERISK (\*) ONLY ATTENDED A MEETING AND DID NOT ACTIVELY PARTICIPATE. VIOLENCE OR REVOLUTIONARY ACTIVITIES WERE NOT DISCUSSED.

Information recorded on a card index by \_\_\_\_\_ on date \_\_\_\_\_

Remarks:

- 100-14427 (MIC)
- 170-286A-39
- 100-14483 (Tom Hyde)
- 100- (Phil Plymate)
- 100-14376 (St. Journal)
- 100-15112 (Sunrise)
- 100-14373 (Phelps)

Block Stamp

170-286A 39

SEARCHED <input checked="" type="checkbox"/>	INDEXED <input checked="" type="checkbox"/>
SERIALIZED <input checked="" type="checkbox"/>	FILED <input checked="" type="checkbox"/>
SEP 25 1970	

*Christensen*

REPORT BY JEROME  
September 18, 1970

This morning I went to Message Information Center, arriving there at about 10:30 AM. Already there were TOM HYDE and a young high school kid named STEVE (LNU) who was learning how to be a MIC operator.

I shot the breeze with HYDE for about an hour. He told me he is now Acting Co-ordinator for MIC. He said there will be a change in MIC leadership as he, HYDE, will be leaving in about a month. He did not say where he is going.

The former MIC co-ordinator, PHIL PLYMATE, is supposed to be going to work full time with the San Diego Street Journal. According to HYDE, both the Street Journal and Sunrise are supposed to be out again in a few weeks. HYDE said there will be mostly new people on the Street Journal staff.

HYDE also talked about MIC's "Fugitive File". This file contains information on how to help deserters and draft dodgers get out of San Diego. He said the file had been taken out of MIC and hidden because many of the people connected with this work had been questioned about it recently by the law.

*Jerome*

He said that when things cooled down, the file will be improved and put back into MIC. He said one of the things they planned to do is to ask anyone who calls for help if he is a Federal Agent, thus hoping to trap him. He also said that apparently some of the servicemen who were helped in the past spilled the whole story about MIC and other people when they got back to their Base.

I stayed at MIC until about one o'clock. After awhile HYDE left, and I spent the rest of the time showing STEVE how to do the work. I received and gave out a lot of weird messages. I was able to obtain the following interesting information:

HYDE's telephone number is 582-8203. PLYMATE's telephone number is 232-8657. New Adult Communities new telephone number is 239-2119, and RICK PHELPS' new address and emergency only telephone number are 2810 31st Street, telephone number 283-1934.

I agreed to pull another shift at MIC this Thursday from 1:00 to 5:00 PM.

*Jerome*



Date prepared  
9/30/70

Date received: 9/21/70  
Received from (name or symbol number): ~~INF~~ \*  
Received by: SA Steven L. Christensen

Method of delivery (check appropriate blocks)  
 in person  by telephone  by mail  orally  recording device  written by Informant

If orally furnished and reduced to writing by Agent:  
Date \_\_\_\_\_  
Dictated \_\_\_\_\_ to \_\_\_\_\_  
Transcribed \_\_\_\_\_  
Authenticated by Informant \_\_\_\_\_

Date of Report  
9/21/70

Date(s) of activity  
9/20/70

Brief description of activity or material  
Info re \*MM activities &  
Bill Clay

File where original is located if not attached  
170-286A

\* INDIVIDUALS DESIGNATED BY AN ASTERISK (\*) ONLY ATTENDED A MEETING AND DID NOT ACTIVELY PARTICIPATE. VIOLENCE OR REVOLUTIONARY ACTIVITIES WERE NOT DISCUSSED.  
 Information recorded on a card index by \_\_\_\_\_ on date \_\_\_\_\_

Remarks:  
~~152-1795~~  
~~100-177461~~ (MM)  
170-286A-40  
100-141293 (Clay)  
100-134174 (SDS)

Index: Wyndham Arthur  
Henshaw; Dr.  
100-12375 Fred Schwartz

Block Stamp

170-286A-40  
SEARCHED INDEXED  
SERIALIZED FILED  
OCT - 8 1970  
FBI - SAN DIEGO

REPORT BY JEROME  
On September 21, 1970

BARRY GODFREY told me that he contacted BILL CLAY yesterday who gave him three boxes of papers belonging to the SDS Group at the University of California at San Diego. CLAY apparently got them from one of the janitors out there.

CLAY has almost completed his pilots training and will get a pilot's license next month. After that he intends to use his license to fly various places to carry on right wing activities.

A possible new Minute-man member is WYNHAM or WYNDMAN ARTHUR HENSHAW who lives at 1902 Guy Street, in the Mission Hills area of San Diego, with telephone number 298-4480. He and several other people including a woman named LYLIA BUCK, a group from Scott Memorial Baptist Church and a group from the Christin Anti-Communist Crusade the leader of which is Dr. FRED SCHWARTZ, are planning to go to the Victory march in Washington, D.C., on October 3, 1970. The group from the Baptist Church is chartering an airplane to fly there.

When I talked to BILL CLAY yesterday I told him what I was doing at Message Information Center and he suggested putting some kind of listening device on the telephone there. He said he would start experimenting around at work today to see what he could come up with.

He told me he has gotten ahold of some new three strand wire which is transparent to the eye and can only be seen under certain lighting conditions. He said this wire is being used in some experiments at the University of California at San Diego.

*Jerome*

Date prepared

9/30/70

Date received

9/24/70

Received from (name or symbol number)

[Redacted] \*

Received by

SA Steven L. Christensen

Method of delivery (check appropriate blocks)

in person  by telephone  by mail  orally  recording device  written by Informant

If orally furnished and reduced to writing by Agent:

Date

Dictated

to

Transcribed

Authenticated by Informant

10/9/70

Brief description of activity or material

MM activities

Date of Report

9/24/70

Date(s) of activity

9/23/70

File where original is located if not attached

170-286A

\* INDIVIDUALS DESIGNATED BY AN ASTERISK (\*) ONLY ATTENDED A MEETING AND DID NOT ACTIVELY PARTICIPATE. VIOLENCE OR REVOLUTIONARY ACTIVITIES WERE NOT DISCUSSED.

Information recorded on a card index by \_\_\_\_\_ on date \_\_\_\_\_

Remarks:

157-1798  
~~100-72461~~ (CUM)

170-286A-41

100-14356 (Peter Ruplinger)

100-14869 (Barry Godfrey)

100-14293 (Clay)

100-15356 (George Hoover)

~~100-157-1810~~ (Frank Yacopac)

100-15381 (STR Rally)

100-14911 (People's Commune)

Index : Mike McGarr  
Gerald Moran  
Charles Throp

Block Stamp

170-286A-41  
SEARCHED [ ] INDEXED [ ]  
SERIALIZED [ ] FILED [ ]  
OCT - 5 1970  
FBI - SAN DIEGO  
[Signature]

REPORT BY JEROME  
September 24, 1970

Yesterday PETER RUPLINGER told me that the Minutemen now have obtained the following Post Office Boxes:

- 1) Post Office Box 3064  
La Mesa, California  
In the name of HOWARD GODFREY or MIKE MC GAN
- 2) Post Office Box 76  
Spring Valley, California  
In the name of GERALD MORAN
- 3) Post Office Box 2351  
La Mesa, California  
In the name of CHARLES THROP

Some right wing people are excited about the STP rally on October 3, 1970, and may attempt to create a little excitement. One of the suggestions made was to place black powder or primacord in the cracks along the railroad tracks over which the marchers will pass and ignite it as they go by.

I learned that approximately one month ago FRANK YACOPEC shot a large size steal nut through a window of the Commune at 2nd and Thorn striking a hippie inside squarely on the side of the head. The hippie dropped as if shot but nothing has been heard about it since.

GEORGE HOOVER has been very quiet lately and no one, including BILL CLAY seems to know where he is or what he is doing.

I learned this afternoon that STP is going to hold a meeting at the 2nd and Thorn Commune at 3:00 P.M., today which I will attend if I can.

*Jerome*

SAC, SAN DIEGO (100-14376)

9/22/70

SA ARNOLD W. O'BRIEN

SAN DIEGO STREET JOURNAL  
SM - ANA

~~\_\_\_\_\_~~ telephonically advised SA O'BRIEN as follows: on 9/26/70:

Information has come to sources attention that the San Diego Street Journal intends to re-instate the paper and will attempt to get out an issue of the Street Journal within the next two weeks.

According to source, the Street Journal intends on devoting a great deal of its journalistic efforts towards women's liberation.

Source stated that information has come to his attention that the Street Journal has an unlisted telephone number 235-4478. According to source, individuals desiring to contact the Street Journal telephonically contact the Message Information Center (MIC) at 531 19th Street, San Diego, California. The MIC will not give out the unlisted telephone number of the Street Journal, but will forward any information desired.

- 1 - 100-14376
- ① - 170-286 X
- 1 - 100-14720 (Women's Liberation)
- 1 - 100-14427 (MIC)

AWO:vlh  
(4)

~~\_\_\_\_\_~~ advised that he received the information contained in this memo from JIM STEWART, who is connected with MIC.

Source further advised that he believes he has the opportunity of getting into the MIC organization and can be placed on a tour of duty with MIC in the near future. *100-14376-42*

*vlh*

SEARCHED _____	INDEXED _____
SERIALIZED _____	FILED _____
OCT - 7 1970	
FBI - SAN DIEGO	

*[Signature]*

Date prepared  
10/6/70

Date received 9/25/70  
Received from (name or symbol number) [redacted] \*  
Received by SA Stewart L. Christensen

Method of delivery (check appropriate blocks)  
 in person  by telephone  by mail  orally  recording device  written by Informant

If orally furnished and reduced to writing by Agent:  
Date Dictated 10/6/70 to Linda Etelegido  
Transcribed 10/6/70  
Authenticated by Informant 10/9/70  
Date of Report 9/25/70  
Date(s) of activity 9/24/70

Brief description of activity or material  
Info re MIC, STP Rally  
Exploring Family School  
File where original is located if not attached  
170-286A

\* INDIVIDUALS DESIGNATED BY AN ASTERISK (\*) ONLY ATTENDED A MEETING AND DID NOT ACTIVELY PARTICIPATE. VIOLENCE OR REVOLUTIONARY ACTIVITIES WERE NOT DISCUSSED.  
 Information recorded on a card index by \_\_\_\_\_ on date \_\_\_\_\_

Remarks:  
100-14427 (MIC)  
170-286A-43  
100-15381 (STP)  
100-14376 (St. Journal)  
100-14737 (Family School)

Block Stamp

170-286A-43  
SEARCHED INDEXED  
SERIALIZED FILED  
OCT - 8 1970  
FBI - SAN DIEGO  
[Signature]

SEPTEMBER 25 1970

Yesterday, I spent four hours at Message Information Center, working the switchboard from 1:00 PM to 5:00 PM. I spent most of my time there copying about 300 names and addresses from the MIC files which I will furnish in the near future.

Last night, there was an STP organizing meeting at the Street Journal building at Second and Thorn. Apparently, that was the only STP meeting which will be held before the STP demonstration on 10/3/70.

Exploring Family school has apparently moved to El Cajon and has a new telephone number which I will also furnish soon.

JEROME

*Jerome*

Date prepared

10/6/70

Date received

10/2/70

Received from (name or symbol number)

~~XXXXXXXXXX~~ \*

Received by

SA Steven L. Christensen

Method of delivery (check appropriate blocks)

in person  by telephone  by mail  orally  recording device  written by Informant

Orally furnished and reduced to writing by Agent:

Date

Dictated 10/2/70 to Linda Elegido

Date of Report

10/2/70

Transcribed 10/6/70

Authenticated by Informant 10/9/70

Date(s) of activity

10/1/70

Brief description of activity or material

Info re MIC

File where original is located if not attached

INDIVIDUALS DESIGNATED BY AN ASTERISK (\*) ONLY ATTENDED A MEETING AND DID NOT ACTIVELY PARTICIPATE. VIOLENCE OR REVOLUTIONARY ACTIVITIES WERE NOT DISCUSSED.

Information recorded on a card index by \_\_\_\_\_ on date \_\_\_\_\_

Remarks:

00-14427 (MIC)

70-286A-44

00-13847 (SMC)

00- (Mike Milligan) (dead if no file)

157-781 (Burt Halsetma)

00-14737 (Family School)

~~00-12461~~ (MM)

157-1798

Index: Orange County True  
Press to 100-12461  
157-1798

Block Stamp

170-286A-44

SEARCHED	INDEXED
SERIALIZED	FILED
OCT - 8 1970	
FBI - SAN DIEGO	

Christensen



OCTOBER 2, 1970

Attached are some lists of names, addresses and telephone numbers which I got at MIC. The one page list with telephone numbers only is the Student Mobilization Committee (SMC) contact list which includes some high school students. The second page list with both addresses and telephone numbers is a list of MIC operators and contacts.

I also learned that MIKE MILLIGAN lives at 7080 Saranac, San Diego, but has telephone numbers 460-2515, 460-6100 and 469-3080.

Exploring Family school has telephone number 442-5287.

BURT HALSEMA has P. O. Box 15602, Andrew Jackson Station, San Diego, California, and telephone number 442-9092.

Attached is the latest copy of the Orange County True Press which was received in one of the Minutemen mail boxes.

JEROME

*Jerome*

McKenna 2395706 in Diego High  
 Brown 582-9433  
 Ki Houghton 583-9003 Crawford  
 Jan Kato 583-1104 Crawford  
 Tommy Palmer 295-9231 Mesa  
 Joley Gaulton 221-2795 Kappa Hall Cal. Western  
 Tom Meyers 273-5795 Mesa?  
 Bud Seika 502-6304  
 Judge Gonzalez 281-4138  
 Bob Peterson 208-2293  
 Earl Fleming 262-5719 Spencil note  
 Herb Hunter 262-6360 " "  
 Petra Glenn 258-2790 " "  
 Unitarian Church 295-9778  
 Rhett Alexander 239-9506  
 Issy Flann 482-1067  
 Tony Ferrara 235-7291  
 Caryl Allen BSU 263-1251  
 Charles Roberts 231-5629  
 Dale Brown 278-1640  
 Carl Choshir 582-0355  
 Byron King SDS 234-1535  
 John Mortinoro " "  
 Art I Ladd 461-2436  
 Keith Harrison 583-1026  
 Tony Holjos USDB 431-0621  
 Gena Crislen no phone P.O. Box 3411 S.D. 92103  
 Kent & Pat Wilson 2133 N. Santa Fe Vista, Ca. 92083 724-7563  
 James Sawyer  
 Tom Hyde 531 19th St. S.D. M.I.C. 232-6621  
 Charles Richmond S.I.C. Grosmont 444-4513  
 Gary DiCarlo ? Grosmont ? ask above might be from International U.  
 Jack Canine ? " " "  
 Ed Davis 7404 Alvarado Rd. #114 no phone  
 Marty Wilson 583-4566 Patrick Henry \*  
 Arne Bonowia (Bonnie's sister) no phone  
 Terry Anderson 277-1176 Indison  
 Robbie Tucker 222-9732 \* Point Loma  
 Brian Whitfield 274-0227 Indison  
 Bert Brown 229-8351 Point Loma  
 Eric Lindloff 465-6949 P.H.  
 Barbara Segal 582-1978 P.H.  
 Kelly Franklin 583-5247 P.H.  
 Kyle Connors 465-4531 P.H.  
 Sue K Kovacs Mesa ? ask Alan 583-5476

- 1) We need more H.S. contacts, someone should concentrate on this.
- 2) All the colleges in our area need more work, with the exception of Grosmont
- 3) We should discuss how to talk to people, how to follow up leads, etc.
- 4) We should keep a centralized list of all new anti-war contacts

STUC U M I I 465 3069

*Jerome*

583-2100

ra Adelman	3611 31st St., 92104	283-8358
Benson		
and Bleu	6208 Tarragona Dr. 92115	286-9971
eg Brown	5139 Clairemont Mesa Blvd., 92117	-
die Brown	2545 "J" St., 92102	232-3538
laine Budzinski	3009 1/2 Beech, 92102	583-3088
Frank & Donna Buhrman	173 Cedaridge Dr., 92114	479-7151
Angel Chesebro	2627 "C" St. 92102	MIC
Mary Clark	2627 "C" St., 92102	MIC
Colby Crotzer	2529 Island Ave. 92102	MIC
Danny Davis	7719 Orien St., La Mesa 92041	-
David Doan	4374 Lograno Dr. 92115	286-4888
Sharon Dunn	1232 W. Redwood, Apt. D,	-
Tom Dunn,	4520 Olney St., 92109	-
Gini Fenley	2545 "J" St., 92102	232-3538
Ozzie Gontang	3323 Boundary St., 92104	-
Linda Greenwell	173 Cedaridge, 92114	479-7151
Sandy Horner	410 26th St., 92102	233-4529
Bill Hulsey	835 Halecrest Dr., Chula Vista	420-0843
Tom Hyde	2529 Island, 92102	235-9231
Eil�en Jackson	2565 "J" St., 92102	233-5501
Bill King	2069 Abbott, #3, 92107	-
Don Knight	6262 1/2 Stanley Ave., 92115	286-8784
Jan Labao	1639 Guy St., 92103	295-4201
Dan MacDonald	1300 Dale St., 92102	232-6200
Susan, Gerre, Dick McKenna	1535 29th Street, 92102	239-5766
Viola McKern	3023 Washington, Lemon Grove 92045	469-3777
Beth Marley	4263 Lamont St, 92109	-
Larry Meyer	3705 Mission Blvd., 92109	488-3475
Jane Mills	615 Circle Dr., Solana Beach 92075	755-1251
Egor & Sandy Parker	3830 44 St., #8, S.D.	283-9644
Jack Rice	1008 Edgemont Pl., S.D.	-
Doyce Ross	1408 Ebbs St., 92114	-
Robin Russell	173 Cedaridge, 92114	479-7151
Bob Sanders	4260 Narragansett, 92107	223-3675
Paul Schoulmann		463-3735
Mari Ruth Seamna	807 Redondo Ct., 92109	488-8706
Sheryl Semans	2545 "J" St., 92102	232-3538
Ann Spangler	5162 Pirotte, 92105	262-0661
June Stanley	803 Redondo Ct., 92109	-
Betty Strickler	814 Diamond, S.D.	-
Chris Strydesky	1352 Dale, 92102	-
Sean Sweeney	106 "B" St., Imperial Beach,	-
Robbie Tucker	3644 Liggett Dr., S.D.	222-9734
Lisa Urso	2545 "J", 92102	232-3538
Wayne Wilson	556 61st St., 92102	-
Mike DeVore	2588 "J" St., 92102	2340-9052
Sherri McDonald	4674 Isleta Ave., 92117	273-6850
Ron & Shirley Snowden	417 27th St., 92102	233-7936
Betsy Beloff		

*Jerome*

ADAM RICE  
PRINTED

Direct  
California 9210

ADDITIONS - MIC OPERATOR LIST  
(for home use)

Arton	8745 Hartzel Dr. Spring Valley	460-5246
Sherton	8745 Hartzel Dr. Spring Valley	460-5246
Lecht	4916 Nevada Pl.	281-7163
own	2412 J. St. S.D. 92102	235-9265
Cascio	4266 Lamont St. S.D. 92109	274-8939
Le Davidson	3004 Greyling Dr. S.D.	274-2962
ay Dempster	743 Ensenada Court S.D. 92109	488-3560
ic Doan	4374 Logrono Dr. S.D. 92115	286-4888
Wne A. Dugan	2529 Island, S.D.	235-9231
ome Lunn	4266 Lamont St. S.D.	274-8939
Pat Fero	2176 Julian St. S.D. 92113	234-7518
Margo Gallagher	3201 Mobley St., S.D.	277-3683
Sheri Macdonald	4674 Isleta Ave. S.D. 92117	273-6850
Jim McDonald	4874 Isleta Ave. S.D. 92117	273-6850
John A. Richardson	2529 Island Ave. S.D.	235-9231
Bill Sanger	4266 Lamont	274-8939
Herman Shoemaker Jr.	1542 Gowin St. Spring Valley, 92077	469-4748
dawn Leilani Smith	2881 Murray Ridge Rd	278-8709
Steven C. Spencer	2122 Ocean View S.D.	232-2680
Carol Tozer	5019 Williams Ave. La Mesa, 92041	460-7686
Carol Winkler	4052 Casita Way	583-2415

*Jerome*

Date prepared  
10/6/70

Date received: 10/5/70  
Received from (name or symbol number): ~~XXXXXXXXXX~~ \*  
Received by: SA Steven L. Christensen

Method of delivery (check appropriate blocks)  
 in person  by telephone  by mail  orally  recording device  written by Informant

If orally furnished and reduced to writing by Agent:  
Date  
Dictated: 10/6/70 to Linda Elegido  
Transcribed: 10/6/70  
Authenticated by Informant: 10/9/70

Date of Report: 10/5/70  
Date(s) of activity:

Brief description of activity or material  
Info re STP Rally 10/3/70

10/3/70

File where original is located if not attached  
170-286A

\* INDIVIDUALS DESIGNATED BY AN ASTERISK (\*) ONLY ATTENDED A MEETING AND DID NOT ACTIVELY PARTICIPATE. VIOLENCE OR REVOLUTIONARY ACTIVITIES WERE NOT DISCUSSED.  
 Information recorded on a card index by \_\_\_\_\_ on date \_\_\_\_\_

Remarks:  
100-15381 (STP) ~~Letter~~: Committee to Free the Soledad Brothers ~~to the~~  
170-286A-45 ~~157 new~~  
100-14372 (Progressive Labor Party) 157-2185  
105-7212 (Nibbe)  
105-7221 (Calderon)  
157 ~~100~~-new (Soledad Brothers Trial)  
RM  
100-157-1482 (Frank Yacopac)  
100-14770 (Women's Liberation)  
100-14622 (Experimental College)

Block Stamp

170-286A-45  
SEARCHED  INDEXED   
SERIALIZED  FILED   
OCT 10 1970  
FBI - SAN DIEGO

OCTOBER 5, 1970

I discretely observed the STP demonstration last Saturday. The march and rally looked like a failure to me because they only had 200 people participating when they had announced that they expected 4,000 or 5,000 to join in.

I was really surprised at the hostility of the bystanders and onlookers toward the marchers. Many of them were yelling "Communist", "Pigs", and "Go to Russia" at the marchers. The sailors and Marines along Broadway were very menacing and several times I thought there were going to be fist fights.

The demonstrators did not stop at the 11th Naval District Headquarters building or at the Police Department headquarters but just walked by chanting and shouting obscenities.

There were three speakers for the rally at Newtown Park. The first was RON NIBBE, who apparently had just been arrested by the police and talked about his arrest and how it was unjustified. He said everyone should be good Communist comrades and buy guns. He said that the people should oppose and defeat the police and completely eliminate them. He said it was unwise to seek community control of the police and by having them live in the communities because then they would know what was going on all the time.

The next speaker was a young male Negro individual who said he was a representative of the Committee to Free the Soledad Brothers. He said the Soledad brothers trial is going to be moved to San Diego and that as much of the committee as possible would also be moved to San Diego. He said however, that many people who belonged to and worked with the committee up north won't be able to come to San Diego and that the committee needs volunteers from the San Diego area to carry on its work. I didn't know what this person's name was.

The last speaker was CARLOS CALDERON who said he wanted to organize the Chicano movement and truth about the great heritage of the Latinos and gave several examples such as CHE GUEVARRA with whom he apparently was very impressed.

*Jerome*

It was announced that Experimental College at San Diego State College is going to have a workshop course on Communism this fall.

At the rally, there was a guy going around selling a copy of "Challenge" saying that it was a Communist newspaper. I believe I heard someone call him by the name of MIKE. He was about 6'1" tall, 220 pounds, brown hair, receding at the forehead, 28 years old. He was accompanied by a girl name KATHY, who is apparently connected with Women's Liberation and PLP. KATHY was about 5'5", in her early 20's, curly brown hair, very slim build. These people said that there is a new discussion meeting each Sunday on "Challenge" and PLP and wrote down the address and phone number down for me, 3993 Broadway, San Diego, telephone 263-1465.

FRANK YACOPEC was also at the rally wearing an old felt hat full of holes, a phoney FU MANCHU mustache and a fatigue jacket. No one paid any attention to him.

Leaving the rally, I almost got into a fight with three people who were very uptight and thought I must have been a Lefty.

*Jerome*

Date prepared

10/19/70

Date received

10/7/70

Received from (name or symbol number)

[Redacted]

Received by

SA Steven L. Christensen

Method of delivery (check appropriate blocks)

in person  by telephone  by mail  orally  recording device  written by Informant

If orally furnished and reduced to writing by Agent:

Date

Date of Report

10/7/70

Dictated

10/12/70 to Glen Fuller

Date(s) of activity

Transcribed

10/15/70

10/7/70

Authenticated by Informant

Brief description of activity or material

Info re Jim Stewart; M.A. O'Connell  
Anti-War Rally 10/31/70

File where original is located if not attached

170-286A

\* INDIVIDUALS DESIGNATED BY AN ASTERISK (\*) ONLY ATTENDED A MEETING AND DID NOT ACTIVELY PARTICIPATE. VIOLENCE OR REVOLUTIONARY ACTIVITIES WERE NOT DISCUSSED.

Information recorded on a card index by \_\_\_\_\_ on date \_\_\_\_\_

Remarks:

100-15475 (Jim Stewart) Index: Glen Moore to  
170-286A-46  
100-13697 (Shapiro)  
100-14922 (CMC)  
~~157-1796~~  
~~100-12461~~ (MM)  
157-1568 (Margaret L. McNichols)  
100-14319 (Barry Godfrey)  
100-15414 (10/31/70 Rally)

Block Stamp

170-286A-46

SEARCHED	INDEXED
SERIALIZED	FILED
OCT 20 1970	
FBI - SAN DIEGO	



10/7/70  
by Jerome

JIM STEWART, the fellow who has in his possession SYLVIA SHAPIRO's CMC mailing list, is about 19 years old, clean cut, short hair, seems to be very intelligent and I believe he is a student. He lives near the beach and it looks like he is a person who is mainly responsible for organizing the anti-war demonstration in San Diego on 10/31/70.

I heard some very interesting information about a store at Julian named the Mountain Market Grocery. Apparently the people at the store are openly advising for the Minutemen organization and are selling minutemen and other right-wing literature over the counter at the store. I was also told that collections for DE PUGH's legal defense are also being taken at the store. I will probably go up there soon and see what's going on.

I learned from BARRY GODFREY that GLENN MOORE picked up a hippie female hitchhiker earlier in the week. She was apparently very radical, but MOORE got friendly with her and she told him that the recent fires in the mountains were mostly set by leftists and were part of a leftist plot.

I also learned that there is going to be a showing of a film and a fund raising event at the Kent Theater on 10/15/70 to raise money and to make plans for the anti-war demonstration on 10/31/70.



# City Wide ANTI-WAR Meeting

The National STUDENT MOBILIZATION COMMITTEE has called for nation-wide mass demonstrations for OCTOBER 31st. The SMC here in San Diego, in line with this national day of protest to the war in Vietnam, is calling for a city-wide organizational meeting to make OCTOBER 31st in San Diego the biggest ever !!!!! If you are opposed to the war . . . . . COME AND HELP !!!!!!!

OCTOBER 10 — SATURDAY — 11:00 — MONTEZUMA HALL, AZTEC CENTER SDSC

## ON TO OCT. 31ST !!

Information recorded on a card index by \_\_\_\_\_ on date \_\_\_\_\_

Remarks:

100-15475 (Jim Stewart)

Index: Glen Moore to

170-286A-46

100-13697 (Shapiro)

100-14922 (CMC)

~~151-4746~~  
~~100-1246~~ (MM)

157-1518 (Margaret L. McNichols)

100-14819 (Barry Godfrey)

160-15414 (10/31/70 Rally)

Block Stamp

170-286A-46

SEARCHED	INDEXED
SERIALIZED	FILED
OCT 10 1970	
FBI - SAN DIEGO	

Date prepared

10/19/70

Date received

10/8/70

Received from (name or symbol number)

[Redacted] \*

Received by

SA Steven L. Christensen

Method of delivery (check appropriate blocks)

in person

by telephone

by mail

orally

recording device

written by Informant

If orally furnished and reduced to writing by Agent:

Date

Dictated

10/12/70 to Glen Fuller

Transcribed

10/15/70

Authenticated by Informant

Date of Report

10/8/70

Date(s) of activity

10/8/70

Brief description of activity or material

Info re MIC + Phil Plymate

File where original is located if not attached

170-286A

\* INDIVIDUALS DESIGNATED BY AN ASTERISK (\*) ONLY ATTENDED A MEETING AND DID NOT ACTIVELY PARTICIPATE. VIOLENCE OR REVOLUTIONARY ACTIVITIES WERE NOT DISCUSSED.

Information recorded on a card index by \_\_\_\_\_ on date \_\_\_\_\_

Remarks:

100-14427 (MIC)

170-286A-47

100-15399 (Phil Plymate aka Plymate)

Block Stamp

170-286A-47

SEARCHED <input checked="" type="checkbox"/>	INDEXED <input checked="" type="checkbox"/>
SERIALIZED <input checked="" type="checkbox"/>	FILED <input checked="" type="checkbox"/>
OCT 20 1970	
FBI - SAN DIEGO	

*[Signature]*

10/8/70  
Jerome

While I was at MIC today I learned about an individual who is believed to be an undercover police officer by the leftists. This individual is 40 to 50 years old, has dark greying hair, is unshaven and goes by the name BODINE or BOLIVAR or some such similar name. Apparently he showed up several weeks ago looking for a ride to the east coast. He claimed to have been connected with a free school somewhere in California and also at Santa Barbara. He always carries a sleeping bag with him and "crashes" wherever he can. The people here have been checking on him and contacted the free schools at Santa Barbara and in Colorado and found out that he wasn't known there. This plus the fact that he is still around after having looked for a ride to the east coast makes him believe he is with the police.

I also saw and met PHIL PLYMALE. He is extremely weird looking and has a very strange beard and hair-do even for the people at Message Information Center. He impresses me as being very paranoid and is highly suspicious of everyone.

Date prepared

10/19/70

Date received

10/12/70

Received from (name or symbol number)

[Redacted] X

Received by

SA Steven L. Christensen

Method of delivery (check appropriate blocks)

in person  by telephone  by mail  orally  recording device  written by Informant

If orally furnished and reduced to writing by Agent:

Date

Dictated

10/12/70 to Glen Fuller

Transcribed

10/15/70

Authenticated by Informant

Date of Report

10/12/70

Date(s) of activity

10/9 - 11/70

Brief description of activity or material

Info re Marg McNichols, PAM Org, AVG, Robert DePugh, Sunrise Bill Clay

File where original is located if not attached

170-286A

\* INDIVIDUALS DESIGNATED BY AN ASTERISK (\*) ONLY ATTENDED A MEETING AND DID NOT ACTIVELY PARTICIPATE. VIOLENCE OR REVOLUTIONARY ACTIVITIES WERE NOT DISCUSSED.

Information recorded on a card index by \_\_\_\_\_ on date \_\_\_\_\_

Remarks:

157-1515 (Margaret L. McNichols) Index: Patriotic Action Legion to 157- John Ozemanec to AVG. Glenn Jackson to 100-13832. Non-violent Action Center to Jim Stewart.

170-286A-45

100-12461 (MM)

100-13832 (Patriotic Party)

100-100-14541 (AVG)

100- (Julian Commune - open 100 dead)

100-15712 (Sunrise)

100-157-1820 (Frank Yacofec)

100-15428 (Jim Stewart)

100-~~14376~~ 14376 (St. Journal)

100-14293 (Bill Clay)

Block Stamp

170-286A-45

SEARCHED _____	INDEXED _____
SERIALIZED _____	FILED _____
OCT 20 1970	
FBI - SAN DIEGO	

*[Handwritten signature]*

10/12/70

Jerome

Last Friday, I went up to Julian to the Mountain Market Grocery Store and met the owner, whose name is MARGIE MC NICKLES. MC NICKLES sells Minutemen, Ku Klux Klan and other similar literature and material across the counter at her store.

She is also working with the Patriotic Party in San Diego and told me that she is going to try to form a chapter of the Patriotic Action Legion in San Diego.

Her son is supposed to be President of the Young Republicans Organization at Grossmont College.

She told me that ROBERT DE PUGH has been on trial for all the Federal charges against him at Albuquerque, New Mexico, and has been held in the City Jail there. She said DE PUGH was to have been sentenced on 10/9/70 and said that he was asking for a total of ten years each on nine separate counts.

MC NICKLES said that the jailors at the Albuquerque City Jail are taking very good care of DE PUGH as most of them are very sympathetic to him. MC NICKLES also made a statement to the effect that if DE PUGH is sent to Leavenworth he will never get there which I took to mean that there may be an escape attempt.

MC NICKLES also said that she knows JOHN ZEMANEC of AVG and GLENN JACKSON of the Patriotic Party at Los Angeles. She showed me an open letter which DE PUGH wrote to ZEMANEC telling him to get completely out of right-wing activities. She also had some other stuff which she claimed to have just recently received from DE PUGH.

MC NICKLES also told me there is a commune at Julian not far from her place. She said these people are long hairs, but clean and drive nice cars. She said they moved in several months ago paying \$32,000 cash money for the house. She said

that although the former owner of the house told her he sold the house to a woman she has seen only male individuals at the house. She said there are only a few individuals who stay at the house during the week, but that several carloads of male individuals arrive each Friday evening and stay over until Monday morning. She said she and her husband feel that some kind of training is going on at the commune as they have been able to hear radio Morse Code signals from the house in the evenings when the wind is right..

She said the person who is always at the house, which is located on Whispering Pines Drive, drives a Car with California License TXL 136 which also has a Yale sticker on it. She said cars with the following license plates have shown up there on the weekends:

VGL 342  
OKU 316  
RGD 465  
WTH 134

I have learned that SUNRISE now has a bookstore at 4855 El Cajon Boulevard. FRANK YACOPEC has been talking about breaking the windows of the store.

JIM STEWART, address 5854 Ithaca Place, telephone 453-4867, has apparently been connected with a group called the Non-violent Action Center.

"The San Diego Street Journal" has a brand new telephone number which is 235-4478.

BILL CLAY went out of town Friday night and did not get back until late Sunday night. He now has his pilot's license and is certified to fly solo and wherever he went he flew.

CLAY told me that the Minutemen lost some stuff during the recent fires in the back country. He said included in the losses were a Lewis Machine Gun and several other small machine guns and some ammunition and explosives which

weren't buried deep enough. He said the losses weren't serious and that most of the stuff weren't hurt. He was talking about running a survey to locate all the buildings and warehouses and other places in the county where ammunition and explosives are stored so that these places could be cleaned out or blown up in the event it looked like the left was serious about starting the revolution.

He was also talking about unburying 500 pounds of explosives to have ready to use in the event of an emergency. He also said the Minutemen in the area have acquired a new 20mm Caliber Lahti anti-tank rifle.



UNITED STATES GOVERNMENT

# Memorandum

TO : SAC, SAN DIEGO (157-1793)

DATE: 1/8/71

FROM : SA STEVEN L. CHRISTENSEN

SUBJECT: MINUTEMAN ORGANIZATION (MM)  
RM - MM

On this date ~~\_\_\_\_\_~~ advised of the following information.

In his contacts with members of the MM organization and other Right Wing activists and sympathisers, it has become apparent that some of these individuals are ~~making~~ making efforts to establish a list of targets which would be subject to sabotage or would be taken out of commission in the event these individuals deemed that a communist or other totalitarian takeover of the federal government appeared imminent.

In this regard source advised he had recently been in contact with JERRY LYNN DAVIS and GEORGE HOOVER. They told source of having made a trip to Ramona, California, for the express purpose of observing the FBI radio station there as a possible target of sabotage as described above. Source said these individuals expressed surprise at finding no armed guards posted at the radio station. They also said they had found no other protective devices such as observation or alarm systems or fences.

Source did not know the exact date DAVIS and HOOVER were at Ramona, and apparently neither he nor the other two are aware of the existence of two FBI radio installations at Ramona. This fact was not disclosed to source.

- 1 - SD 157-1793 (MM)
- 1 - SD 100-14297 (JERRY LYNN DAVIS)
- 1 - SD 100-15356 (GEORGE HOOVER)
- ① - SD 170-236A

SLC/slc  
(4)

170-236A-49

SEARCHED _____	INDEXED _____
SERIALIZED <u>F</u>	FILED <u>F</u>
JAN 8 1971	
FBI - SAN DIEGO	

Date prepared  
1/27/71

Date received  
10/12/70

Received from (name or symbol/number)  
~~XXXXXXXXXX~~ X

Received by  
SA Steven L. Christensen

Method of delivery (check appropriate blocks)  
 in person  by telephone  by mail  orally  recording device  written by Informant

If orally furnished and reduced to writing by Agent:  
Date  
Dictated \_\_\_\_\_ to \_\_\_\_\_  
Transcribed \_\_\_\_\_  
Authenticated by Informant \_\_\_\_\_

Date of Report  
10/12/70  
Date(s) of activity  
Week ending 10/12/70

Brief description of activity or material  
Info re Sam Davis, Barry Godfrey,  
Geo. Hoover + MM activities

File where original is located if not attached  
170-286A

\* INDIVIDUALS DESIGNATED BY AN ASTERISK (\*) ONLY ATTENDED A MEETING AND DID NOT ACTIVELY PARTICIPATE. VIOLENCE OR REVOLUTIONARY ACTIVITIES WERE NOT DISCUSSED.

Information recorded on a card index by \_\_\_\_\_ on date \_\_\_\_\_

Remarks:

- 100-14819 (Barry Godfrey)
- 170-286A-50
- 100-14297 (Sam Davis)
- 100-15356 (George Hoover)
- 100-9857 (Harry Raja)
- 157-1798 (MM)
- 100-15112 (Sunrise)

170-286A-50  
Block Stamp

SEARCHED  INDEXED   
SERIALIZED  FILED   
JAN 27 1971  
FBI - SAN DIEGO  
Christensen

On 10/12/70  
By Jerome

It has been learned that BERRY GODFREY was in contact with SAM DAVIS last Saturday. Apparently he and GEORGE HOOVER and several other people are planning to change their names, occupations and so on and try to disappear. They are supposed to be going "north", however the exact location is not known. Their purpose in doing this is to start a Minutemen Commune as a base of operations against the Left. They have photographs which they claim were taken of people at Communes in the Northern California area wearing fatigues and practicing with rifles. They will try to locate these communes and conduct terrorist activities against them.

It was also learned that DAVIS attended a recent gun show at El Paso, Texas. He reportedly said he would put GODFREY in touch with his suppliers, who can get anything in the way of weapons, ammunition and explosives and other articles when he leaves.

Apparently DAVIS and HOOVER will put this plan into effect during the first part of 1971.

It is known that HARRY RUJA, Professor at San Diego State College, has been more active lately. He has been involved in trying to organize some sit-ins and some protests against the arrest of LEON NOWER. He looks as though he may be trying to take NOWER's place as the radical faculty leader at San Diego State College.

It was also learned that a Datsun pickup truck which RUJA drives to work was burned up on his driveway last Saturday night. It is suspected that some of the local Minutemen may have been responsible.

It was also learned that over the last weekend the windows at the Sunrise Book Store were broken.

*Jerome*

BETTIE HOUGHTON has not been seen for several months. She is not reported to be doing anything and it looks as though everyone is more or less staying away from her. It is believed however she is still being contacted by DENNIS MOWER from Los Angeles.

*Jerome*

Date prepared  
1/27/71

Date received  
10/15/70

Received from (name or symbol number)  
[Redacted] \*

Received by  
SA Steven L. Christensen

Method of delivery (check appropriate blocks)

in person  by telephone  by mail  orally  recording device  written by Informant

If orally furnished and reduced to writing by Agent:  
Date

Date of Report  
10/15/70

Dictated \_\_\_\_\_ to \_\_\_\_\_

Date(s) of activity  
10/14/70

Transcribed \_\_\_\_\_

Authenticated by Informant \_\_\_\_\_

Brief description of activity or material

Weapons in possession of  
Jerry Geyer

File where original is located if not attached  
170-286A

\* INDIVIDUALS DESIGNATED BY AN ASTERISK (\*) ONLY ATTENDED A MEETING AND DID NOT ACTIVELY PARTICIPATE. VIOLENCE OR REVOLUTIONARY ACTIVITIES WERE NOT DISCUSSED.

Information recorded on a card index by \_\_\_\_\_ on date \_\_\_\_\_

Remarks:

100-15400 (Jerry Geyer)  
170-286A-51

170-286A-51  
Block Stamp

SEARCHED \_\_\_\_\_ INDEXED \_\_\_\_\_  
SERIALIZED \_\_\_\_\_ FILED \_\_\_\_\_  
JAN 20 1971  
FBI - SAN DIEGO  
[Signature]

On 10/15/70  
By Jerome

It has been learned that JERRY GEYER had the following weapons at his house last night:

Two fully automatic .30 caliber M-2 carbines;

Three .45 caliber grease guns;

One Thompson Sub-Machine Gun;

One Swedish K ( 9mm grease gun style weapon);

A Colt Commando Carbine (A new experimental automatic weapon in .223 caliber which Colt hopes will replace the M-16.)

These weapons were all supposedly in good condition and were fully operational. They apparently belonged to a friend of GEYERS. It may be that the weapons are going to a gun show to be held at Yuma, Arizona next weekend. However GEYER is offering any and all the weapons for sale now.

*Jerome*

Date prepared

1/27/71

Date received

11/3/70

Received from (name or symbol number)

~~XXXXXXXXXX~~ \*

Received by

SA Steven L. Christensen

Method of delivery (check appropriate blocks)

in person  by telephone  by mail  orally  recording device  written by Informant

Orally furnished and reduced to writing by Agent:

Date

Date of Report

11/3/70

Dictated \_\_\_\_\_ to \_\_\_\_\_

Date(s) of activity

Week ending  
11/3/70

Transcribed \_\_\_\_\_

Authenticated by Informant \_\_\_\_\_

Brief description of activity or material

Activities of Geo. Hoover, Sam Davis, etc.

File where original is located if not attached

170-286A

INDIVIDUALS DESIGNATED BY AN ASTERISK (\*) ONLY ATTENDED A MEETING AND DID NOT ACTIVELY PARTICIPATE. ABSENCE OR REVOLUTIONARY ACTIVITIES WERE NOT DISCUSSED.

Information recorded on a card index by \_\_\_\_\_ on date \_\_\_\_\_

Remarks:

- 57-1798 (MM)
- 70-286A-52
- 100-14297 (Davis)
- 100-15356 (George Hoover)
- 100-14819 (Godfrey)
- 100-157-2224 (Isaac Cantrell)
- 100-14356 (Peter Ruppinger)
- 100-13847 (SMC)
- 100-157-820 (Frank Yacopac)

Info relating to SA Arnold W. O'Brien was properly handled at time of receipt.

Index Mississippi license F/6192030 to 100-14297.

Block Stamp

170-286A-52

SEARCHED <input checked="" type="checkbox"/>	INDEXED <input checked="" type="checkbox"/>
SERIALIZED <input checked="" type="checkbox"/>	FILED <input checked="" type="checkbox"/>
JAN 27 1971 FBI - SAN DIEGO	

*[Signature]*

11/3/70  
By Jerome

Attached is an SMC leaflet which I recently picked up at SDSC.

It appears that GEORGE HOOVER and SAM DAVIS are bosom buddies. They invited me to go to the Gunsmoke Ranch in Harbison Canyon last Sunday. They were both there and I also met ROGER WILLIS. In addition there were three women and two other males at the ranch whose names I did not learn.

DAVIS was in Mississippi recently and at the ranch he was driving a green Chevrolet van with Mississippi license F/6192030. He apparently broke down somewhere in Texas on the way back and HOOVER went to rescue him.

On the ranch there is a pistol range and a range with ~~photos~~ up and running targets but that part was burned down in a recent fire. The range is being rebuilt. There are also two muzzle loading cannons on the ranch and there is a bunker or open mine shaft type of thing in the side of a hill. I could see shoring and supports inside but was not allowed to get close enough to see what it was.

HOOVER and DAVIS were practicing quick-draw shooting and hip shooting and are supposedly good shots with a .45 caliber automatic pistol. They are always armed at least with .22 caliber derringer pistol.

SAM DAVIS has many M-2 carbine parts which he will sell at a good price. He gets a lot of his stuff from a place in Los Angeles, and he has approached BERRY GODFREY asking him to stop at that place the next time he is in Los Angeles and obtain some hand grenade casings. The casings are apparently being sold for \$1.00 a piece.

I learned that the house HOOVER lived in on the ranch was burned in the fire. I also learned that there are two fellows named STAN (LNU) and DAVE (LNU) who live on the ranch.

While I was there SAM was thinking about staging a punitive raid on the SDPD in retaliation for the arrest of ISSAC CANTRELL. He said however he did not know CANTRELL.

*Jerome*



DAVIS said he feels that the FBI and SDPD are communist controlled and he wants to neutralize them. In particular DAVIS has a special hate for Agent O'BRIEN of the FBI. He said he knows that most of the Agents are decent people who are just doing their job. However he feels that O'BRIEN is persecuting the Minutemen as a vengeance and said he would give anything to get O'BRIEN's home address and telephone number.

DAVIS said he was going to price some tear gas grenades and said he could get primacord in 500 foot lengths for \$30.00.

It was learned that the SMC anti-war march 11/1/70 was a complete failure. There were only 150 - 200 people who participated in the march, with a few more attending the rally. Nothing of interest happened and the speeches given were dull and uninteresting.

I was in contact with PETER REPLINGER yesterday. He said there has been evidence of many students in the school turning against the new left movement. He said apparently the Street Journal and its staff had been caught in some bad lies which had caused many students to be disillusioned.

It was also learned that SAM DAVIS wants to order 10000 .223 caliber bullets through BARRY GODFREY's contact which will cost \$255. It was also learned that FRANK YACOPEC wants to order 1000 M-1 carbine bullets.

*Jerome*

# IS THE WAR GOING TO END ?

NIXON SAYS WE ARE WITHDRAWING.....BUT:

FACT: Last week the Super Carrier Ranger left for Vietnam with over 5,000 men and 125 planes.

FACT: Friday morning the Carrier U.S.S. Kitty Hawk leaves San Diego also for Vietnam with another 5,000 men and 125 planes.

# THIS IS ESCALATION NOT WITHDRAWAL

This war is costing you, the taxpaying citizen, \$2 million each and every day, that is approximately \$1500 a year for every man, woman and child in this country.

Because a war economy is non-productive inflation has run wild, 10% per year nationwide. Because of this war the average citizen made less real money this year than last despite pay increases. Our paychecks buy less and less each week.

This is a rich man's war. How many of the "Big Brass" get shot up? How many millionaires lose a son or father to keep this war going? FOR WHAT?

Many of the sailors on this ship realize this and do not wish to go. They will be gone today but the fight to end the war goes on. Disgust with the war is rampant within the military itself.

So long as the apathetic state of the people continues so will the war. The time to sit passively and watch has passed. Now is the time for responsible action to end the war in Vietnam.

Servicemen and civilians are working together to end this war for the first time in history. Show your support for the servicemen today.

BRING ALL THE TROOPS HOME NOW!!

Date prepared

1/27/71

Date received

10/29/70

Received from (name or symbol number)

[Redacted] \*

Received by

SA Steven L. Christensen

Method of delivery (check appropriate blocks)

in person  by telephone  by mail  orally  recording device  written by Informant

If orally furnished and reduced to writing by Agent:

Date

Date of Report

10/29/70

Dictated \_\_\_\_\_ to \_\_\_\_\_

Date(s) of activity

Transcribed \_\_\_\_\_

10/29/70

Authenticated by Informant \_\_\_\_\_

Brief description of activity or material

Info re Bill Clay & SDS at  
UCSD

File where original is located if not attached

170-286A

\* INDIVIDUALS DESIGNATED BY AN ASTERISK (\*) ONLY ATTENDED A MEETING AND DID NOT ACTIVELY PARTICIPATE. VIOLENCE OR REVOLUTIONARY ACTIVITIES WERE NOT DISCUSSED.

Information recorded on a card index by \_\_\_\_\_ on date \_\_\_\_\_

Remarks:

- 100-14293 (Bill Clay)
- 170-286A-53
- 100-14819 (Godfrey)
- 100-13474 (SDS)
- 100-13847 (SMC)
- 157-1798 (MM)

Block Stamp

170-286A-53

SEARCHED \_\_\_\_\_ INDEXED \_\_\_\_\_  
 SERIALIZED 25 FILED B  
 JAN 11 1971  
 FBI - SAN DIEGO  
 [Signature]

On 10/29/70  
By Jerome

I was told that BERRY GODFREY was in touch with BILL CLAY today. CLAY claims that there have been the beginnings of some right wing activities at UCSD. He said that the SDS there tried to stage a protest against the Marine Corps Recruiter which was scheduled to come to the campus. He said one SDS member dragged an American flag across the quad and for his efforts was beaten up by a couple of members of a new right wing group at the school.

The SDS had planned to protest the number of Negro Marines who have been killed in Vietnam, however the Marine Corps set a Negro Recruiter to the school which really threw water on their plans.

According to CLAY it appears that a real confrontation may be brewing between the conservative and radical students at UCSD. It was also learned that CLAY now has his private pilots license.

It has also been learned that BERRY GODFREY and other members of the Minutemen group may be present at the SMC march and rally on 11/1/70.

*Jerome*

Date prepared

1/27/71

Date received

11/9/70

Received from (name or symbol number)

~~XXXXXXXXXX~~ A

Received by

SA Steven L. Christensen

Method of delivery (check appropriate blocks)

in person  by telephone  by mail  orally  recording device  written by Informant

If orally furnished and reduced to writing by Agent:

Date

Dictated \_\_\_\_\_ to \_\_\_\_\_

Transcribed \_\_\_\_\_

Authenticated by Informant \_\_\_\_\_

Date of Report

11/9/70

Date(s) of activity

Week ending  
11/9/70

Brief description of activity or material

MM activities

File where original is located if not attached

170-286A

\* INDIVIDUALS DESIGNATED BY AN ASTERISK (\*) ONLY ATTENDED A MEETING AND DID NOT ACTIVELY PARTICIPATE. VIOLENCE OR REVOLUTIONARY ACTIVITIES WERE NOT DISCUSSED.

Information recorded on a card index by \_\_\_\_\_ on date \_\_\_\_\_

Remarks:

157-1798 (MM)

170-286A-54

100-14356 (Peter Ruppinger)

100-14293 (Bill Clay)

100-12464 (Melvin Crain)

~~100~~ (Kenneth Goff) index

100-15000 (LARGO)

Block Stamp

170-286A-54

SEARCHED <u>7</u>	INDEXED <u>7</u>
SERIALIZED <u>1</u>	FILED <u>13</u>
JAN 27 1971	
FBI - SAN DIEGO	

On 11/9/70  
By Jerome

I was in contact with PETER REPLINGER last Saturday. He told me he has agreed to take charge of all the Minutemen records which are presently being kept by BERRY GODFREY. PETER is getting ready for his upcoming wedding and consequently has not been to active lately.

I have noticed that someone has been painting a number of pro-Minutemen slogans on bridge abutments and overpasses around the La Mesa and El Cajon area lately.

I had a chance to talk to BILL CLAY this morning. He is still upset about MELVIN CRAIN. He thinks CRAIN is behind a large part of the left wing activities in the county. He said he believes CRAIN has a lot of weapons and ammunition stored away on his Hollyoaks Ranch in Harbison Canyon.

CLAY also mentioned that KENNETH GOFF was in town yesterday. He said GOFF was and probably still is a close associate of DE PUGH. CLAY said GOFF is sort of a religious fanatic. He suspects GOFF may have concealed DE PUGH for awhile when DE PUGH was in hiding. He said GOFF was here to speak to a group of right wing people and said about 40 individuals attended the speech.

CLAY said GOFF told him of the existance of a left wing revolutionary army which is operating in this country. He said this army uses the name "Largo" and allegedly obtains its orders and instructions by code through a TV Program named "Dark Shadows". He said the code used is supposed to be based on the sixth and seventh chapters of one of the books of Moses in the bible, which is somehow inserted into the TV program's script. He also said there have been references to "Largo"

*Jerome*

in recent issues of "News Week" and "Saga" magazines.  
If he can find out what issues it was in, he will try  
and get them.

*Jerome*

Date prepared

1/27/71

Date received

11/10/70

Received from (name or symbol number)

[Redacted] \*

Received by

SA Steven L. Christensen

Method of delivery (check appropriate blocks)

in person  by telephone  by mail  orally  recording device  written by Informant

Orally furnished and reduced to writing by Agent:

Date

Dictated \_\_\_\_\_ to \_\_\_\_\_

Transcribed \_\_\_\_\_

Authenticated by Informant \_\_\_\_\_

Brief description of activity or material

MM activities

Date of Report

11/10/70

Date(s) of activity

11/10/70

File where original is located if not attached

170-286A

INDIVIDUALS DESIGNATED BY AN ASTERISK (\*) ONLY ATTENDED A MEETING AND DID NOT ACTIVELY PARTICIPATE. PRESENCE OR REVOLUTIONARY ACTIVITIES WERE NOT DISCUSSED.

Information recorded on a card index by \_\_\_\_\_ on date \_\_\_\_\_

Remarks:

- 57-1998 (MM)
- 170-286A-55
- 100-14016 (Bettie Houghton)
- 100-14819 (Godfrey)
- 100-14296 (Lou Conde)
- 100-14293 (Clay)
- 100-157-3374 (Isaac Cantrell)
- 100-14297 (Davis)

170-286A-55  
Block Stamp

SEARCHED	INDEXED
SERIALIZED	FILED
JAN 13 1971	
FBI - SAN DIEGO	

*[Signature]*



On 11/10/70  
By Jerome

Attached are copies of some new Minutemen stickers and posters which the local group has been putting out. They are supposedly printed by Alex Rapid Print in La Mesa. They are being mailed out to many people and are also handed out locally around town.

It is known that BETTIE HOUGHTON was in contact with BARRY GODFREY last night. She was very excited about the posters and stickers and said she was very glad to see some activities getting started. She said she is reorganizing some of her contacts and group and said that the new posters and stickers had caused such a flury in town that the whole Minutemen organization might really get going again. She said LOU CONDE had apparently received some of the stickers and posters and was excited about them. It looks as though there are many people just sitting around waiting for something like this to happen so they could get involved.

It was also learned that BETTIE Gave GODFREY some plates with which to make some big Minutemen posters. She also said she has nearly 500 negatives which can be used to make plates for printing posters and leaflets.

I had a chance to talk to BILL CLAY again. He maintained that there may have been some connection between DAVIS and ISSAC CANTRELL awhile ago. CANTRELL is the one who was arrested by local and federal authorities for unlawful possession and manufacture of automatic weapons.

*Jerome*

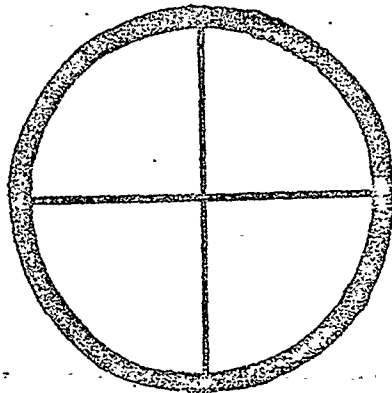

**COMMUNIST TRAITORS  
BEWARE**

**EVEN NOW THE CROSS-HAIRS  
ARE AT THE BACK  
OF YOUR NECK** MM

# HELP STOP COMMUNISM



JOIN THE  
"Minutemen"

An organization of loyal Americans  
dedicated to the preservation of both  
national and individual freedom.

Insist on a strong stand by our own government  
against communism-- in Cuba as well as in Vietnam.  
Demand that we stop sending supplies to Russia and  
her communist satellites while American boys are  
being killed in Vietnam by Russian bullets-- clean  
out the traitors and parasites in our own federal  
bureaucracy. Be prepared to help stop armed communist  
invasion or violent revolution.

For further information on the Minutemen  
organization, send a stamped self-addressed envelope to

Date prepared  
1/27/71

Date received: 11/18/70  
Received from (name or symbol number): ~~XXXXXXXXXX~~ \*  
Received by: SA Steven L. Christensen

Method of delivery (check appropriate blocks)  
 in person  by telephone  by mail  orally  recording device  written by Informant

If orally furnished and reduced to writing by Agent:  
Date: \_\_\_\_\_  
Dictated \_\_\_\_\_ to \_\_\_\_\_  
Transcribed \_\_\_\_\_  
Authenticated by Informant \_\_\_\_\_

Date of Report  
11/18/70

Date(s) of activity  
11/18/70

Brief description of activity or material  
Info re James Richard Buss  
and Stephen Smith

File where original is located if not attached  
170-286A

\* INDIVIDUALS DESIGNATED BY AN ASTERISK (\*) ONLY ATTENDED A MEETING AND DID NOT ACTIVELY PARTICIPATE. VIOLENCE OR REVOLUTIONARY ACTIVITIES WERE NOT DISCUSSED.  
 Information recorded on a card index by \_\_\_\_\_ on date \_\_\_\_\_

Remarks:  
67-7967  
170-286A-56  
157-1798 (NAM)  
100-14296 (Conde)  
100-14302 (Vejvoda)  
100-14301 (Rupflinger)  
100-15400 (Jerry Geyer)

Index: Colonel Shimp;  
Daniel Predovich;  
Digiscan to 67-7967  
"Benny the Barber" to  
157-1798

170-286A-56  
Block Stamp

SEARCHED \_\_\_\_\_ INDEXED \_\_\_\_\_  
SERIALIZED 12 FILED \_\_\_\_\_  
JAN 27 1971  
FBI - SAN DIEGO  
Christensen

NOVEMBER 18, 1970  
BY JEROME

The photo of JAMES RICHARD BUSS is totally unfamiliar to me and I don't believe I have ever seen this individual before. His name is also not familiar to me.

I was fairly well-acquainted with STEPHAN SMITH. He was in the San Diego area for a period of approximately a year and left six to eight months ago. I was told that he went back north, which I assume to mean Los Angeles or San Francisco.

SMITH was married and lived with his wife at Rancho Bernardo while he was in this area. He was very involved in the Right vs Left confrontation, which took place in Poway last year over the make up of the Poway School Board. He was involved there with Colonel SHIMP, the NORMANS, and other people who were opposed to DANIEL PREDOVICH as School Board Chairman and some of whom who were considering ways of getting rid of PREDOVICH.

While SMITH was in this area, he was closely associated with known members of the Minutemen organization, such as MICHAEL VEJBODA, PAUL RUPLINGER and LOU CONDE. I do not know if SMITH is or was a member of the Minutemen organization, but if not, he was not a member in name only as he appeared to be in total agreement with the far Right extremist, radical, political philosophies of VEJBODA, RUPLINGER and CONDE. SMITH's wife was also extremely Right Wing and on one occasion helped pass out Minutemen organization leaflets. SMITH was involved as a partner with LOU CONDE in a business, which was named DIGISCAN. DIGISCAN was supposed to have been an electronics research and manufacturing outfit, the main purpose of which was to develop and sell a police communications system whereby each individual police officer could, at all times, be in constant touch with some police base station. SMITH and CONDE apparently had a quarrel about the business and split up, and I believe there may be a law suit pending over ownership of some of the equipment, which belonged to the company.

*Jerome*

As a sidelight, SMITH would build monitoring and "bugging" devices for a price. He also had electronic equipment for use in searching buildings and other places for hidden electronic monitoring devices or "bugs".

I heard recently that MICHAEL VEJBODA is presently living in Salt Lake City.

There is to be a big gun show in Campo on the weekend of November 21, and 22, 1970, and from the talk I have heard, it sounds as though it will be a regular gathering of the Minutemen organization and other Right Wingers in this area. JERRY GEIER, I know, will be there with weapons to show and sell.

BENNY, the barber who has all the machine guns and rifles in his barber shop, is located on the west side of 30th Street, about 1½ blocks north of El Cajon Boulevard.

*Jerome*

Date prepared

1/29/71

Date received

11/16/70

Received from (name or symbol number)

[Redacted] \*

Received by

SA Steven L. Christensen

Method of delivery (check appropriate blocks)

in person  by telephone  by mail  orally  recording device  written by Informant

If orally furnished and reduced to writing by Agent:

Date

Dictated \_\_\_\_\_ to \_\_\_\_\_

Transcribed \_\_\_\_\_

Authenticated by Informant \_\_\_\_\_

Date of Report

11/16/70

Date(s) of activity

11/14/70

Brief description of activity or material

Info re activities of Sam Davis and Peter Ruppinger

File where original is located if not attached

170-286A

\* INDIVIDUALS DESIGNATED BY AN ASTERISK (\*) ONLY ATTENDED A MEETING AND DID NOT ACTIVELY PARTICIPATE. VIOLENCE OR REVOLUTIONARY ACTIVITIES WERE NOT DISCUSSED.

Information recorded on a card index by \_\_\_\_\_ on date \_\_\_\_\_

Remarks:

157-1798 (MM)  
170-286A-57  
100-14297 (Davis)  
100-17464 (Melvin Crane)  
100-11920 (Si Casady)  
100-7738 (Dorothy Healey Ph)  
100-157-1824 (Frank Yacopec)  
100-14293 (Bill Clay)  
100-14819 (Godfrey)  
100-14356 (Peter Ruppinger)  
2 - Los Angeles  
(1-400 Frank W. Corrigan)

Index: "Doc Robert's"  
Frank W. Corrigan

Block Stamp

170-286A-57  
SEARCHED [initials]  
SERIALIZED [initials]  
FEB 1 1971  
FBI - SAN DIEGO  
[initials]

11/16/70  
by JEROME

I was in contact with SAM DAVIS last Saturday evening. For some reason he was quite upset and was talking about making plans for a tactical squad of six or so individuals with which to harass and terrorize left wing sympathizers in the San Diego area. He said he wanted to have a meeting this coming Friday evening to try to map out some strategy. In particular, he seems to want to conduct a raid on MELVIN CRANE's ranch. He said he would shoot the Doberman Pincers CRANE has guarding the place, ransack the house then burn it down.

He was also talking about another place in Harbison Canyon, I will try to get the address later, where he claims Communist Party meetings are being held. Among others, he claims that SI CASADY and DOROTHY HEALEY (phonetic) have been meeting there. He says he wants to raid that place too.

He was also talking about a "Doc Roberts" who he says has many weapons contacts and who may have access to machine guns and hand grenades. He may put me in touch with this person later on.

I have also been talking to FRANK YACOPEC. YACOPEC says he has learned of a possible existence of some bunkers which were buried and abandoned by General PATTON at the start of the second World War. He says the bunkers are supposed to still be full of ammunition and explosives. He claimed he was told of the existence of the bunkers by a former aide of General PATTON. He told me that he, BILL CLAY and BARRY GODFREY may fly up to the location at a later date and look it over. Apparently these bunkers are located somewhere in the desert east of 29 Palms.

I was also in touch with PETER RUPLINGER on Saturday. He stated he has obtained 50 hand grenade fuses and wants to go to Los Angeles to buy 50 hand grenade casings and he will then activate the hand grenades. PETER claimed he has a friend who works at the Frontier Gun Shop in San Diego who is a right wing individuals and is selling unregistered ammunition and firearms. PETER has been carrying a ~~23~~ 22 caliber revolver lately.

22  
*Jerome*



I also learned that SAM DAVIS has an unknown quantity of expendable rocket launchers with rounds which he will sell for \$25 each. He is supposed to be looking for anti-tank weapons and mortars in the hundreds or thousands. DAVIS apparently has a brother who is also very militant and is working with him.

I am supposed to see BETTIE HOUGHTON this evening. She will put out 500 of the new posters and stickers (see attached). The advertising from the posters and stickers has obtained response from as far away as Los Angeles where ~~the~~ a person named FRANK W. CORRIGAN wrote requesting information.

*Jerome*

*Corrigan's address is 5653 Franklin,  
Los Angeles, California.*

Date prepared

1/29/71

Date received

12/1/70

Received from (name or symbol number)

~~XXXXXXXXXX~~ \*

Received by

SA Steven L. Christensen

Method of delivery (check appropriate blocks)

in person  by telephone  by mail  orally  recording device  written by Informant

If orally furnished and reduced to writing by Agent:

Date

12/1/70

Dictated \_\_\_\_\_ to \_\_\_\_\_

Transcribed \_\_\_\_\_

Authenticated by Informant \_\_\_\_\_

Date of Report

12/1/70

Date(s) of activity

11/25/70 to 11/27/70

Brief description of activity or material

Contact with Marge McNickles, Sam Davis & Bill Clay -

File where original is located if not attached

170-286A

\* INDIVIDUALS DESIGNATED BY AN ASTERISK (\*) ONLY ATTENDED A MEETING AND DID NOT ACTIVELY PARTICIPATE. VIOLENCE OR REVOLUTIONARY ACTIVITIES WERE NOT DISCUSSED.

Information recorded on a card index by \_\_\_\_\_ on date \_\_\_\_\_

Remarks:

157-1798 (MM)  
170-286A-58  
157-1818 (Marge McNickles)  
100-13832 (Patriotic Party)  
157- (Daniel T. McNickles) (open dead if no file)  
100-14293 (Clay)  
100-14297 (Davis)  
100-14294 (Howard Clark) (dead if no file)  
100-14292 (Brinker)  
152-2010 C. Jim Moore  
4 - Los Angeles  
157-242 (Gemma's Moore)

Index: ~~Leo Moore~~, Glenn Jackson, Dennis ~~Moore~~, Ed Andrews, Henning Von Beck to 157-1798, Sam Williams to 100-14297

17 (Block Stamp) 58A-58

SEARCHED [initials]  
SERIALIZED [initials]  
FEB 11 1971  
FBI - SAN DIEGO  
[signature]

California license MHD 097 registered  
to 1964 VW Bus owned by Marshall  
Frederic Johnson, 711 - 24th St., Her-  
mosa Beach, Calif.

On 12/1/70  
By JEROME

I was in contact with MARGE MC NICKLES at Julian last Wednesday and talked to her for about three hours. We discussed DE PUGH's status. She said that representatives of the Minutemen organization and the Patriotic Party have been talking to former Chief of Police REDDIN at Los Angeles alleging that DE PUGH is innocent of the bank robbery conspiracy charges on which he was recently convicted. She said she was told REDDIN is sufficiently convinced of the possibility of DE PUGH's innocence that he may search out evidence in this regard on which to base a program for his television show.

She also talked about a JIM MOORE who she said is in California and is on one of MC NICKLES' mailing list. She also mentioned an older man in Los Angeles named FREED who is a leader of the Patriotic Party. She said that DE PUGH's mother is also a Patriotic Party leader and told me that DE PUGH has asked GLENN JACKSON, of Los Angeles, to resign as co-National Patriotic Party Chairman.

MC NICKLES said that she herself is Secretary-Treasurer of the Western Region of the Patriotic Party which covers 11 states. She said in the event of a split in the Patriotic Party between DE PUGH and JACKSON, she will side with DE PUGH. She said she has the bank account and the membership list for the Western Region of the Patriotic Party in her possession.

She also told me that the Minutemen National Headquarters continues to function under BOB DE PUGH, JR., and RAMONA VAN DE PUGH. She said there is a courier traveling between Los Angeles and the Minutemen National Headquarters weekly.

*Jerome*

She asked that her son, DAN T. MC NICKLES, a student at San Diego State College, be used at Right Wing activities and made arrangements for me to meet him this evening at 8:00 p.m., in La Mesa.

MC NICKLES told me there is a woman living in the Julian commune and said she has seen others coming and going there. She gave me the license numbers of two more of the cars she has seen at the commune. One was an out of state license, white background with blue figures XVC 316, which was on a dark green car with white racing stripes, possibly a Mustang, which was at the commune on October 11, 1970. The other was a tan over brown Volkswagen bus with California license MHD 097 which was at the commune on November 2, 1970.

On Friday I saw BILL CLAY and told him about MARGE MC NICKLES. I asked him if he thought we should try to use her to re-establish contact with the Minutemen National Headquarters. CLAY said "I don't know. We'll have to ask SAM about that." I was definitely impressed from the way he made the statement that perhaps he has been taking orders in the Minutemen organization from SAM DAVIS all along.

We then went together to see DAVIS and discussed MC NICKLES with him. He said that we should continue talking with MC NICKLES to see what contact with her would produce. CLAY and DAVIS then got to talking about breaking DE PUGH out of jail at Albuquerque and I related to them what MC NICKLES had told me before about going to Albuquerque to visit DE PUGH. CLAY and DAVIS became very upset and jumped all over me because I had not told them about MC NICKLES being there and about knowing the layout of the Albuquerque City Jail.

After this they started talking idly about getting DE PUGH out of prison at Fort Leavenworth.

DAVIS then stated he had seen DENNIS MOWLER not too long ago and at that time MOWLER was hiding out a girl who was allegedly a former secretary for DE PUGH. He said MOWLER told him that for some reason DE PUGH had people looking for this girl to kill her and that also she was being sought by the FBI.

*Jerome*

DAVIS continued talking and indicated the possibility he hold a higher position in the Minutemen organization in the State of California than we previously suspected. He said he has been using the name SAM WILLIAMS in some of his other contacts and Minutemen activities.

CLAY then mentioned a former San Diego area Minuteman named ED ANDREWS who he thought had always been very reliable. He said he had previously understood ANDREWS to be somewhere in the State of Arkansas but said VIC WALTON had told him that ANDREWS was back at Ramona, California, some time ago.

They also talked about HOWARD CLARK as a reliable Minuteman member. He also apparently lives at Ramona and is employed at Convair. MC NICKLES is also well acquainted with CLARK and they said we should use CLARK as a reference to MC NICKLES to gain her confidence.

CLAY and DAVIS want to have another meeting soon for the purpose of setting up a schedule or list of targets in the San Diego area to hit in the event it appears that a communist or other totalitarian takeover in this country appears imminent. From my contact with CLAY and DAVIS it appears that there has been considerable improvement in the communications and coordination among the Right Wings in this area.

Additionally, regarding my contact with MC NICKLES, she told me she is Neo-Nazi. She also said she is in contact with JOSEPH BRINKER and also said that HENNING VON BECK is in town. She said he is the son of a General VON BECK who was in the German army and was executed at the Nurenberg trials. She said he told her that last week some one fired a rifle bullet through the windshield of his automobile and regularly gets letters from Jews announcing they are out to get him.

She also told me that the local telephone installer at Julian, a man 40 - 45 years old, is also a Minuteman and that he checks her telephone for her to determine if it is being bugged.

*Jerome*

Date prepared

1/29/71

Date received

12/2/70

Received from (name or symbol number)

[Redacted] \*

Received by

SA Steven L. Christensen

Method of delivery (check appropriate blocks)

in person  by telephone  by mail  orally  recording device  written by Informant

If orally furnished and reduced to writing by Agent:

Date

Date of Report

12/2/70

Dictated \_\_\_\_\_ to \_\_\_\_\_

Date(s) of activity

Transcribed \_\_\_\_\_

Authenticated by Informant \_\_\_\_\_

12/2/70

Brief description of activity or material

Info re Anthony Kao in  
Kailua, Hawaii

File where original is located if not attached

170-286A

\* INDIVIDUALS DESIGNATED BY AN ASTERISK (\*) ONLY ATTENDED A MEETING AND DID NOT ACTIVELY PARTICIPATE. VIOLENCE OR REVOLUTIONARY ACTIVITIES WERE NOT DISCUSSED.

Information recorded on a card index by \_\_\_\_\_ on date \_\_\_\_\_

Remarks:

100-0- (Anthony Kao)  
170-286A-59  
2 - Honolulu

Index: Fashion  
Wig Imports to  
100-0. Also  
Stephen Saed

170-286A-59  
Block Stamp

SEARCHED [initials]  
SERIALIZED [initials]  
FEB 11 1971  
FBI - SAN DIEGO  
[Signature]

On 12/2/70  
By JEROME

My parents, who just recently returned from Hawaii, told me about a person named ANTHONY KAO they had been in contact with while in Hawaii. They said KAO owns and operates a business named Fashion Wig Imports which is located in the Ala Moana Building on Wanaao Place in Kailua, Hawaii.

They said KAO made a number of statements which were anti-United States and pro-communist China in nature. They said KAO, who is Chinese, is closely connected with many Chinese communist businessmen and is currently trying to act as a sponsor to help immigrate two men from Taiwan into the United States.

They also said he <sup>knows</sup> ~~has~~ another ~~man~~ <sup>J</sup> man named STEPHEN SUED, of Yugoslav nationality, who they said was trying to run for some public office in the recent elections in Hawaii. <sup>Sued allegedly makes</sup> regular trips to Yugoslavia. <sup>J</sup>

Jerome



Date prepared

1/29/71

Date received

12/3/70

Received from (name or symbol number)

[Redacted]

Received by

SA Steven L. Christensen

Method of delivery (check appropriate blocks)

in person  by telephone  by mail  orally  recording device  written by Informant

If orally furnished and reduced to writing by Agent:

Date

Dictated \_\_\_\_\_ to \_\_\_\_\_

Transcribed \_\_\_\_\_

Authenticated by Informant \_\_\_\_\_

Date of Report

12/3/70

Date(s) of activity

12/2/70

Brief description of activity or material

Info re Norman's at  
Poway + John Bush

File where original is located if not attached

170-286A

\* INDIVIDUALS DESIGNATED BY AN ASTERISK (\*) ONLY ATTENDED A MEETING AND DID NOT ACTIVELY PARTICIPATE. VIOLENCE OR REVOLUTIONARY ACTIVITIES WERE NOT DISCUSSED.

Information recorded on a card index by \_\_\_\_\_ on date \_\_\_\_\_

Remarks:

157-1798 (MM)  
170-286A-60  
100-15355 (John Bush)

170-286A-60  
Block Stamp

SEARCHED [initials]  
SERIALIZED [initials]  
FEB 1 1971  
FBI - SAN DIEGO  
[Handwritten signature]

On 12/3/70  
By JEROME

I was in contact with the NORMAN's from Poway yesterday, the father and son. I learned that the father is a landscaper and that he has access to large quantities of ammonium nitrate. The son is a student at Mesa College. Both seemed very willing to help out in any Right Wing activities in this area.

I was also in contact with JOHN BUSH last night. He is still wheeling and dealing in surplus military goods and especially military manuals. I acquired from him a Special Forces Manual on Air Drop Methods and Codes.

*Jerome*

Date prepared

1/29/71

Date received

12/11/70

Received from (name or symbol number)

[Redacted]

Received by

SA Steven L. Christensen

Method of delivery (check appropriate blocks)

in person  by telephone  by mail  orally  recording device  written by Informant

If orally furnished and reduced to writing by Agent:  
Date

Date of Report

12/11/70

Dictated \_\_\_\_\_ to \_\_\_\_\_

Date(s) of activity

12/11/70

Transcribed \_\_\_\_\_

Authenticated by Informant \_\_\_\_\_

Brief description of activity or material

Info re Gerald Smith \*  
Morris J. Starsky

File where original is located if not attached

170-286A

\* INDIVIDUALS DESIGNATED BY AN ASTERISK (\*) ONLY ATTENDED A MEETING AND DID NOT ACTIVELY PARTICIPATE. VIOLENCE OR REVOLUTIONARY ACTIVITIES WERE NOT DISCUSSED.

Information recorded on a card index by \_\_\_\_\_ on date \_\_\_\_\_

Remarks:

157-1798

170-286A-61

105-134 (Gerald L. K. Smith)

100-157-25 (National Socialist White Peoples Party)

157-196 (White Citizens Council)

100-15337 (Starsky)

170-286-61 Block Stamp

SEARCHED [initials]  
SERIALIZED [initials]  
FEB 1 1971  
FBI - SAN DIEGO  
[Signature]

On 12/11/70  
By JEROME

I am very familiar with the name GERALD L. K. SMITH. He has been operating around the Southern California area for some time and is generally considered to be a finatical extreme right wing militant individual and is kind of nutty. He is or has been involved in the National Socialist White People's Party and in the San Diego White Power Council.

*Attached is copy of Minuteman leaflet  
put out today on Morris J. Starsky.*

*Jerome*

# News Briefs

## STUDENT GOVERNMENT

**COMMITTEE ON COMMITTEES** - Applications for three student positions on Academic Honesty Committee are open. Applications available in AD126 and AS Offices. Deadline Monday.

**COUNCIL** - Arts and letters position open. Applications available in the Organizations Office. Applications due Dec. 15, interviews 3 p.m. Dec. 16.

**HEALTH SERVICES BOARD** - Meeting 11 Monday, Room 231, Health Services Bldg. Open to all students.

**INTERFRATERNITY COUNCIL** - Presidents meeting 10 p.m. today, Rooms B or G, Aztec Center. Del Sud pictures will be taken. Election of IFC rush chairman. Important, please attend.

**PUBLICATIONS BOARD** - Meeting 11, Tuesday,

ignore it. I have met the enemy and it is me. Now, at the count of three, I will awaken and return to normal. One... Two... Our office PS113, Meetings 11 a.m. Tuesdays, Rooms K and L, Aztec Center.

**COOP. ASSOCIATION** - Meeting 11 a.m. Dec. 15, SS337.

**FOLK DANCING** - Sunday night 7-9, Dec. 13, Room C, Aztec Center. Greek, Israeli, Serbian, American, and many more dances. If you enjoy dancing and meeting new people, make yourself known. Everyone welcome. Bring a friend. It's free.

**GAY LIBERATION FRONT** - Due to weather, Sunday's Gay in will be held at 6851 Alvarado Rd., Apt 14.

**HOUSING CENTER** - Bicycle auction, 10 a.m. Saturday, Aztec Center.

**MODERN DANCE CLUB** - Weekly meeting 11 a.m. Thursdays, WPE. Everyone welcome. No experience necessary.

MORRIS J STARSKY LIVES  
AT 6851 ALVARADO RD.  
APT. 14

*Aug: 15, 1970*

## Controversial Professor Now At S.D. State

TEMPE, Ariz. (AP) - Dr. Morris Starsky, controversial former assistant professor at Arizona State University, is teaching as a visiting lecturer at San Diego State, the State Press has reported.

The chairman of the philosophy department at San Diego State, Dr. Patricia Crawford, has confirmed that Starsky was hired, as of Sept. 1, on a one-year basis to teach two courses, logic and 20th Century philosophy.

The ASU student newspaper said Starsky expressed fears in a telephone interview that an attempt would be made to jeopardize his position at the California college by informing the administration of his past political activities at Arizona State.

Starsky, an admitted Socialist, was placed on one year's terminal sabbatical leave by the Board of Regents last June after dismissing a class to address a rally at the University of Arizona. The faculty committee on academic freedom and tenure had recommended that the charges brought against him be dismissed.

The student newspaper quoted Starsky as saying it was "nice to be away from ASU, away from the public view." The school, he said, "is a fishbowl to the Arizona legislature" with "political control extremely direct since the legislature meets in Phoenix."

Starsky has filed a federal court suit seeking to regain his position as an assistant professor of philosophy.

*12-1-70 SD Union*  
**Arizona Treatment**

Ordinarily the administrators of San Diego State College and the institution's Board of Trustees would not pay much attention to a banquet speaker extolling the 42nd anniversary of "The Militant" - the Socialist Workers' Party newspaper.

We hope that they did last weekend. The speaker was Morris J. Starsky, a dedicated Marxist who was fired from Arizona State University for his active advocacy of far left causes.

Mr. Starsky, now a philosophy professor at San Diego State College, evidently has not changed his stripes. We suggest to San Diego State officials that they consider him a prime candidate for the Arizona treatment.

*Jerome*

Date prepared

1/27/71

Date received

1/4/71

Received from (name or symbol number)

[Redacted]

Received by

SA Steven H. Christensen

Method of delivery (check appropriate blocks)

in person  by telephone  by mail  orally  recording device  written by Informant

If orally furnished and reduced to writing by Agent:

Date

Date of Report

1/4/71

Dictated \_\_\_\_\_ to \_\_\_\_\_

Date(s) of activity

1/3/71

Transcribed \_\_\_\_\_

Authenticated by Informant \_\_\_\_\_

Brief description of activity or material

MM info

File where original is located if not attached

170-286A

\* INDIVIDUALS DESIGNATED BY AN ASTERISK (\*) ONLY ATTENDED A MEETING AND DID NOT ACTIVELY PARTICIPATE. VIOLENCE OR REVOLUTIONARY ACTIVITIES WERE NOT DISCUSSED.

Information recorded on a card index by \_\_\_\_\_ on date \_\_\_\_\_

Remarks:

- 157-1798 (MM)
- 170-286A-62
- 100-15356 (George Hoover)
- 100-15337 (Starsky)
- 100-14296 (Conde)
- 100-157-1576 (Frank Yacofec)
- 100-100-15402 (Jerry Geyer)

170-286A-62 Block Stamp

SEARCHED [ ] INDEXED [ ]  
SERIALIZED [ ] FILED [ ]  
FEB 1 1971  
FBI - SAN DIEGO  
[Signature]

REPORT BY JEROME

JANUARY 4, 1971

He was in contact with GEORGE HOOVER yesterday who apparently has not been doing much of anything. He also saw JERRY GEIER last night who claimed he has made contact with a Minutemen group at Los Angeles which is involved in buying and selling weapons. He told many about some new Minutemen business cards which are coming out of Los Angeles. We got around to talking about hand grenades and GEIER said that although he did not openly solicit hand grenades for money, he would obtain some for money if he happened to run across any.

I am not aware of anyone connected with the Minutemen organization placing Minutemen stickers and posters around MORRIS STARSKY's apartment house or on his car. However, people like LOU CONDE, FRANK YACOPEC and the RUPLINGERS are always good suspects in things like that.

*Jerome*

Date prepared

1/28/71

Date received

1/7/71

Received from (name or symbol number)

[Redacted]

Received by

SA Steven L. Christensen

Method of delivery (check appropriate blocks)

in person  by telephone  by mail  orally  recording device  written by Informant

If orally furnished and reduced to writing by Agent:

Date

Date of Report

1/7/71

Dictated \_\_\_\_\_ to \_\_\_\_\_

Date(s) of activity

1/5/71

Transcribed \_\_\_\_\_

Authenticated by Informant \_\_\_\_\_

Brief description of activity or material

Info re MM activities

File where original is located if not attached

170-286A

\* INDIVIDUALS DESIGNATED BY AN ASTERISK (\*) ONLY ATTENDED A MEETING AND DID NOT ACTIVELY PARTICIPATE. VIOLENCE OR REVOLUTIONARY ACTIVITIES WERE NOT DISCUSSED.

Information recorded on a card index by \_\_\_\_\_ on date \_\_\_\_\_

Remarks:

- 157-1798 (MM)
- 170-286A-65
- 100-15356 (George Hoover)
- 100-14297 (Davis)
- 100-14610 (Stan McRade)
- 100-157-1870 (Frank Yacopec)
- 100-14819 (Godfrey)
- 100-15400 (Jerry Geyer)
- 100- (Roger Willis) Prev opened
- 100-14293 (Clay)
- 100-15355 (Jerry Busch)

Block Stamp

SEARCHED  INDEXED   
 SERIALIZED  FILED   
 FEB 1 1971  
 FBI - SAN DIEGO  
 [Signature]  
 170-286A-63



REPORT BY JEROME

JANUARY 7, 1971

I was talking with GEORGE HOOVER day before yesterday. We discussed an idea which he and SAM DAVIS have had regarding setting up a Civil War Confederate skirmish group similar to other such groups which have been established in other parts of the country. This group will be set up by HOOVER, DAVIS, STAN McDADE, (LNU) MARTINI of the Accuracy Gun Shop, FRANK YACOPEC and BARRY GODFREY. It is expected as many as 50 or 60 other individuals may join the skirmish group, some who will be rightwing oriented people and may who will be just plain gun nuts. These will include JERRY GEIER, ROGER WILLIS and others probably including some from the Patch and Ball Gun Shop crowd.

I have also learned that GEORGE HOOVER and SAM DAVIS have three operational Civil War field artillery pieces which are located on ROGER WILLIS' Gunsmoke Ranch property in Harbison Canyon and may actually belong to him. STAN McDADE is building a 4th artillery piece. He has the gun carriage assembly and has ordered the barrel for the weapon..

*Jerome*

According to HOOVER, the beauty of organizing such a skirmish group is that it will allow the right wingers and Minutemen to use the group as an above ground organization and to openly drill and train with weapons. Members would have their own uniforms and the organization would be set up in a military fashion with officers, ranks, etc., assigned to the members. Persons joining the organization will be protected from police and other outside harassment by being assigned the name of an actual Civil War officer or soldier to use while they are participating in the organization's activities. The existence of the organization will also give the right wingers an excuse to have large quantities of black powder and percussion caps on hand to use for their weapons.

In addition the organization could be used to provide an honor guard to be present at local appearances of right wing speakers and to set up counter-demonstrations against left wing activities.

This skirmish group would be controlled and directed by an underground nucleus of 6 or 8 solid Minutemen members who are not generally known to other members of the skirmish group.

HOOVER and DAVIS are apparently becoming less interested in BILL CLAY as a member and participant in right

*Jerome*

wing activities. According to them, he is too busy now  
adays with his own personal affairs to be of much use.  
For this reason, they have said they don't want him in the  
underground group of Minuteman members who will direct  
the Civil War skirmish.

It has come to my attention that JERRY BUSCH  
has fallen out of favor with most of the Minutemen members  
who do not like or trust him. SAM DAVIS has even threatened  
to shoot him. GEORGE HOOVER still likes him though and  
BUSCH spends most of his weekends at the Gunsmoke Ranch with  
HOOVER and WILLIS. Could their be a romance brewing?

*Jerome*

Date prepared

1/28/71

Date received

1/13/71

Received from (name or symbol number)

[Redacted] \*

Received by

SAs Steven L. Christensen

Method of delivery (check appropriate blocks)

- in person
- by telephone
- by mail
- orally
- recording device
- written by Informant

If orally furnished and reduced to writing by Agent:

Date

Dictated \_\_\_\_\_ to \_\_\_\_\_

Transcribed \_\_\_\_\_

Authenticated by Informant \_\_\_\_\_

Date of Report

1/13/71

Date(s) of activity

1/12/71

Brief description of activity or material

Info re Paul Ruppinger

File where original is located if not attached

170-286A

\* INDIVIDUALS DESIGNATED BY AN ASTERISK (\*) ONLY ATTENDED A MEETING AND DID NOT ACTIVELY PARTICIPATE. VIOLENCE OR REVOLUTIONARY ACTIVITIES WERE NOT DISCUSSED.

Information recorded on a card index by \_\_\_\_\_ on date \_\_\_\_\_

Remarks:

100-14301 (Ruppinger)

100-14296 (Conde)

170-286A-64

Index: Virtue In America

170-286A-64

SEARCHED	INDEXED
SERIALIZED	FILED
FBI - SAN DIEGO	

Christensen

REPORT BY JEROME

JANUARY 13, 1971

I was talking to PAUL RUPLINGER yesterday. He told me he is trying to revitalize the Virtue in America Group (VIA). He said he has been talking to LOU CONDE in an attempt to gain his participation and support for VIA. He also said if he is successful with VIA he may possibly go in with the skirmish group which GEORGE HOOVER and SAM DAVIS have been talking about setting up.

*Jerome*

Date prepared

1/29/71

Date received

1/13/71

Received from (name or symbol number)

[Redacted] X

Received by

SA Steven L. Christensen

Method of delivery (check appropriate blocks)

in person  by telephone  by mail  orally  recording device  written by Informant

If orally furnished and reduced to writing by Agent:

Date

Dictated \_\_\_\_\_ to \_\_\_\_\_

Transcribed \_\_\_\_\_

Authenticated by Informant \_\_\_\_\_

Date of Report

1/13/71

Date(s) of activity

1/13/71

Brief description of activity or material

Info re Marg McNickles and  
MM

File where original is located if not attached

170-286A

\* INDIVIDUALS DESIGNATED BY AN ASTERISK (\*) ONLY ATTENDED A MEETING AND DID NOT ACTIVELY PARTICIPATE. VIOLENCE OR REVOLUTIONARY ACTIVITIES WERE NOT DISCUSSED.

Information recorded on a card index by \_\_\_\_\_ on date \_\_\_\_\_

Remarks:

157-1798 (MM)  
170-286A-65  
157-1818 (McNickles)

Index: Jesse Stephens

Block Stamp

170-286A-65

SEARCHED  INDEXED

SERIALIZED  FILED

FEB 1 1971

FBI - SAN DIEGO

Christensen

On 1/13/71  
By JEROME

I was at Julian today talking to MARGE MC NICKLES. She said she had sent a letter to one of my Post Office Boxes asking me to come and see her. She said it looked as though there had been another split in the Minutemen organization, and showed me a bulletin which she had received from what looks like a new Minutemen group. The bulletin was printed on the original Minutemen letterhead paper and was post marked December 15, 1970. She said she received the bulletin about a week ago.

Regarding the bulletin, MC NICKLES said that in the past there was always talk about DE PUGH and other people in the Minutemen organization regarding an Executive Committee of advisors to DE PUGH. According to the bulletin, it had been sent out by that Executive Committee and announced that during the month of December of 1970, no date given, there had been a meeting of Regional Coordinators of the Minutemen organization at Chicago, Illinois. The bulletin said the Executive Committee was gratified at the large attendance at the meeting and went on to announce that control of the Minutemen organization was being taken away from DE PUGH and the rest of the National Headquarters Group at Norborne, Missouri. The bulletin said this action was being taken as it had been learned that funds of the Minutemen organization had been mis-used, that hallucinatory drugs had been purchased and that effective leadership was lacking at the Norborne Headquarters.

The bulletin said that DE PUGH and his associates should no longer be considered as part of the Minutemen organization. The bulletin advised that all Minutemen literature which had not been copyrighted was being re-printed and was always available for distribution.

*Jerome*

She said the copyrighted Minutemen literature was being reviewed for changes so as to avoid the copyright and would be re-printed.

The bulletin also advised that as a result of the December meeting the country had been divided into ten regions with a Regional Coordinator appointed for each. The bulletin said that the Regional Coordinator would be the individual member's contact with the National Headquarters. The bulletin had a return address of Post Office Box 896, Elgin, Illinois, with a note that the second address appearing on the bulletin was that of the receiving members Regional Coordinator. The note went on to say that if no second address appeared on the bulletin the receiving member was to send all Minutemen organization mail to the Elgin, Illinois, address from where it would be forwarded to the Regional Coordinator. There was no second address on MC NICKLES' copy of the bulletin.

Enclosed with the bulletin were a number of the original Minutemen report forms which are to be filled out and returned. Also enclosed were a number of the original Minutemen application forms which are supposed to be distributed to interested persons.

MC NICKLES told me she has heard of several other people (no names given) in our area who also received the bulletin. She said, however, that apparently none of the JOHN ZEMANEC-GLENN JACKSON group at Los Angeles got them.

With regard to DE PUGH, MC NICKLES told me that the charges against him in the State of Washington have been thrown out of court for lack of evidence. MC NICKLES said she communicates regularly with DE PUGH's wife and received a letter from her not too long ago which requested more money for DE PUGH's legal defense. She said, however, there has been no visible action in this regard and pointed out that the above described bulletin implied that DE PUGH's wife is "blowing" the money which is being received for his defense.

*Jerome*



She said she has also heard a rumor to the effect that DE PUGH's wife is running around on him while he is in prison, but she said she does not believe this is true.

MC NICKLES said DE PUGH's wife had previously mentioned a person named JESSE STEPHENS who may possibly be connected with the group at Elgin, Illinois.

She said STEPHENS supposedly started a Right Wing group some years ago, possibly in the Northwest but was never recognized by DE PUGH.

She said she does not know if STEPHENS is actually connected with the Elgin, Illinois, group.

I will send a letter to the group at Elgin, Illinois, regarding what their plans are. I will use the name JERRY MORAN and the Post Office Box Number 76 at Spring Valley, California.

*Jerome*

Date prepared

1/28/71

Date received

1/14/71

Received from (name or symbol number)

[Redacted] \*

Received by

SA Steven L. Christensen

Method of delivery (check appropriate blocks)

in person  by telephone  by mail  orally  recording device  written by Informant

If orally furnished and reduced to writing by Agent:  
Date

Dictated \_\_\_\_\_ to \_\_\_\_\_

Transcribed \_\_\_\_\_

Authenticated by Informant \_\_\_\_\_

Date of Report

1/14/71

Date(s) of activity

1/14/71

Brief description of activity or material

Info re Paul Ruplinger &  
Venezuela Brigade

File where original is located if not attached

170-286A

\* INDIVIDUALS DESIGNATED BY AN ASTERISK (\*) ONLY ATTENDED A MEETING AND DID NOT ACTIVELY PARTICIPATE. VIOLENCE OR REVOLUTIONARY ACTIVITIES WERE NOT DISCUSSED.

Information recorded on a card index by \_\_\_\_\_ on date \_\_\_\_\_

Remarks:

100-14301 (Ruplinger)

170-286A-66

105-7128 (VB)

100-14293 (Clay)

170-286A-66

Block Stamp	
SEARCHED	INDEXED
SERIALIZED	FILED
FEB 1 1971	
FBI - SAN DIEGO	

Christensen

ON JANUARY 14, 1971, BY JEROME

I was contacted by PAUL REPLINGER this evening. He is planning some protest activities regarding Mayor CURRAN's announcement in today's "San Diego Union" naming tomorrow, January 15, 1971, as MARTIN LUTHER KING Day in San Diego. It was learned that REPLINGER is making up some dummies of Mayor CURRAN and MARTIN LUTHER KING in his basement which will be hung in elegy from the San Diego County Administration Building tomorrow morning. It was also learned that REPLINGER has lined up about 200 persons to make telephone calls to the City switchboard tomorrow morning for the purpose of tying the switchboard up for as long a period of time as possible.

I also learned from BILL CLAY last night there is to be a speech at UCSD on Sunday, January 17, 1971, at 7:30 p.m. on the Venceremos Brigade. I will get more details tomorrow.

*Jerome*

Date prepared

1/28/71

Date received

1/15/71

Received from (name or symbol number)

[Redacted] X

Received by

JA Steven L. Christensen

Method of delivery (check appropriate blocks)

in person  by telephone  by mail  orally  recording device  written by Informant

If orally furnished and reduced to writing by Agent:

Date

Date of Report

1/15/71

Dictated \_\_\_\_\_ to \_\_\_\_\_

Date(s) of activity

1/15/71

Transcribed \_\_\_\_\_

Authenticated by Informant \_\_\_\_\_

Brief description of activity or material

Info re Venceremos  
Brigade

File where original is located if not attached

170-286A

\* INDIVIDUALS DESIGNATED BY AN ASTERISK (\*) ONLY ATTENDED A MEETING AND DID NOT ACTIVELY PARTICIPATE. VIOLENCE OR REVOLUTIONARY ACTIVITIES WERE NOT DISCUSSED.

Information recorded on a card index by \_\_\_\_\_ on date \_\_\_\_\_

Remarks:

105-9128 (VB)

170-286A-67

Index: Revolutionary  
Action Caucus

170-286A-67  
Block Stamp

SEARCHED	INDEXED
SERIALIZED	FILED
FEB 1 1971	
FBI - SAN DIEGO	
[Handwritten signature]	

ON JANUARY 15, 1971, BY JEROME

I obtained a copy of a leaflet advertising a speech on the Venceremos Brigade at UCSD on January 17, 1971. The leaflet invites people to come to hear about Cuba "after the revolution" from people who have gone on the Venceremos Brigades. The speech is to take place at 7:30 p.m. in Room MC 201 and indicated there would be speakers and slides. According to the leaflet, it was put out by a group named the Revolutionary Action Caucus.

*Jerome*

Date prepared

1/28/71

Date received

1/18/71

Received from (name or symbol number)

~~XXXXXXXXXX~~ \*

Received by

SAS Steven L. Christensen

Method of delivery (check appropriate blocks)

in person  by telephone  by mail  orally  recording device  written by Informant

If orally furnished and reduced to writing by Agent:  
Date

Date of Report

1/18/71

Dictated \_\_\_\_\_ to \_\_\_\_\_

Date(s) of activity

1/18/71

Transcribed \_\_\_\_\_

Authenticated by Informant \_\_\_\_\_

Brief description of activity or material

Info re Lou Conde, Geo. Hoover  
Sam Davis, etc.

File where original is located if not attached

170-286A

\* INDIVIDUALS DESIGNATED BY AN ASTERISK (\*) ONLY ATTENDED A MEETING AND DID NOT ACTIVELY PARTICIPATE. VIOLENCE OR REVOLUTIONARY ACTIVITIES WERE NOT DISCUSSED.

Information recorded on a card index by \_\_\_\_\_ on date \_\_\_\_\_

Remarks:

100-14296 (Conde)  
170-286A-68  
105- (Alpha 66) Open Deal  
100-14297 (Davis)  
100-15356 (George Hoover)  
100- (Roger Willis) Open Deal  
100-14301 (Ruffinger)

170-286A-68

SEARCHED	INDEXED
SERIALIZED	FILED
FEB 11 1971	
FBI - SAN DIEGO	
[Signature]	

ON JANUARY 18, 1971, BY JEROME

I have not been in contact with LOU CONDE in some-time; however, I understand he is still politically active especially in the group named Taxpayers Concerned. PAUL REPLINGER is still in regular contact with CONDE.

CONDE has always had a reputation as a "blabber mouth", but actually only talks about little things which are not very important. CONDE is a clever, dynamic, ambitious and hardworking person. He has a lot of money and is very willing to put some of it into right wing activities.

CONDE has many Cuban exile contacts and is a Cuban himself. In particular, he is close to the Alpha 66 group and can get them out to do things for him.

CONDE is in very tight with the local tuna boat association and I would imagine he also has many contacts among the shrimpers and tuna sievers. This is because he has a marine engine and shipfitting business and does much work for the fishing boats.

It is entirely likely that CONDE may be involved in some way with illegal arms shipments on some of these fishing boats between here and some Latin American countries. If this is happening, I doubt that the weapons are coming to the United States through the Latin American countries, but are probably being purchased here and shipped to Cuban guerrilla organizations in Central and South America. It is also possible that CONDE may secretly be doing some work to arm some of the tuna boats to protect them against seizure by such countries as Peru and Ecuador. He mentioned something about this to me about a year ago.

It looks as though I may be going to the Gunsmoke Ranch this coming weekend. They're going to have a pistol shoot there with quite a few people attending. Last weekend they had a shotgun shoot at skeet. The group at the Gunsmoke

*Jerome*

Date prepared  
1/28/71

Date received  
1/18/71

Received from (name or symbol number)  
~~XXXXXXXXXX~~ \*

Received by  
SA Steven L. Christensen

Method of delivery (check appropriate blocks)  
 in person  by telephone  by mail  orally  recording device  written by Informant

If orally furnished and reduced to writing by Agent:  
Date \_\_\_\_\_  
Dictated \_\_\_\_\_ to \_\_\_\_\_  
Transcribed \_\_\_\_\_  
Authenticated by Informant \_\_\_\_\_

Date of Report  
1/18/71

Date(s) of activity  
1/18/71

Brief description of activity or material  
Info re Frank Yacopac

File where original is located if not attached  
170-286A

\* INDIVIDUALS DESIGNATED BY AN ASTERISK (\*) ONLY ATTENDED A MEETING AND DID NOT ACTIVELY PARTICIPATE. VIOLENCE OR REVOLUTIONARY ACTIVITIES WERE NOT DISCUSSED.

Information recorded on a card index by \_\_\_\_\_ on date \_\_\_\_\_

Remarks:

~~100-157-1535~~ (Frank Yacopac)  
170-286A-69  
100-14819 (Godfrey)  
100-14356 (Peter Ruppinger)  
157-1798 (MM)  
100-15133 (Jerry Tartaglio)

Index: Jerry Tartaglio  
to 157-1798

170-286A-69  
Block Stamp

SEARCHED 13 INDEXED 15  
SERIALIZED 1 FILED 15  
FEB - 1971  
FBI - SAN DIEGO  
C. J. [Signature]



ON JANUARY 18, 1971, BY JEROME

I have learned that sometime ago, FRANK YACOPEC and JERRY TARTAGLIO were in contact with a retired Army colonel who claimed he was some kind of an aide to General PATTON, or otherwise connected with him, when PATTON was involved in desert maneuvers and training in the Palm Springs, California, area at about the beginning of the second World War. According to what this colonel said, PATTON and his troops received urgent orders requiring them to pack up and ship out to go overseas with only two days notice. Because of such short notice, rather than taking their heavy equipment and supplies with them, they simply abandoned and buried them in wholesale quantities. I understand that many trucks and tanks were part in ravines and gullies and dirt was bulldozed over them. There are a lot of recorded instances where people have found such buried supplies in the desert out beyond Palm Springs. This area is still all Government property that is very little inhabited any any time. Apparently the Government has either lost its records, forgotten about, or simply doesn't care about all the stuff that is supposed to be buried out there.

In particular, this colonel told YACOPEC and TARTAGLIO about a large concrete bunker with big double steel doors which he said was filled with ammunitions and explosives and also buried. He apparently told TARTAGLIO and YACOPEC how to locate the bunker and I understand that they went out to the desert and after digging through about six feet of sand, actually found the steel doors to the bunker. Following this, they covered the bunker up again and have not been back since.

On the 27th of this month, a group including YACOPEC, BARRY GODFREY and PETER REPLINGER are going to go out to the desert to try and relocate the bunker and dig it out. I understand that REPLINGER has access to a portable jackhammer and some other heavy equipment which he will use to dig out the bunker.

If it is at all possible, I will try and go along with them to see what they actually find.

*Jerome*

Date prepared

1/29/71

Date received

1/25/71

Received from (name or symbol number)

[Redacted] \*

Received by

SA Steven L. Christensen

Method of delivery (check appropriate blocks)

in person  by telephone  by mail  orally  recording device  written by Informant

If orally furnished and reduced to writing by Agent:  
Date

Date of Report

1/25/71

Date(s) of activity

1/24/71

File where original is located if not attached

170-286A

Brief description of activity or material

Info re activities of MM  
at Cusumoke Ranch

\* INDIVIDUALS DESIGNATED BY AN ASTERISK (\*) ONLY ATTENDED A MEETING AND DID NOT ACTIVELY PARTICIPATE. VIOLENCE OR REVOLUTIONARY ACTIVITIES WERE NOT DISCUSSED.

Information recorded on a card index by \_\_\_\_\_ on date \_\_\_\_\_

Remarks:

157-1798 (MM)  
~~170-286A-70~~  
100-14610 (Stan McWade)  
100-15355 (Leroy Busch)  
100-14297 (Doris)  
100-15356 (Geo. Hoover)  
100- (Roger Willis) Prev. O period  
100-14294 (Howard Clark)

Block Stamp

170-286A-70  
SEARCHED [initials] INDEXED [initials]  
SERIALIZED [initials] FILED [initials]  
FBI - SAN DIEGO  
JAN 29 1971

ON JANUARY 25, 1971, BY JEROME

I was at the Gunsmoke Ranch in Harbison Canyon yesterday. When I got there, there were already 15 people present, most of whom I did not know and as I was leaving, three more people, STAN MC DADE and his two sons, arrived. Those I knew among the others present were JERRY BUSCH, SAM DAVIS, GEORGE HOOVER and ROGER WILLIS. Two of the others that I noticed in particular were a young fellow in his early 20's about 5' 6" tall, 130 pounds, dark brown hair, who was called GEORGE, and a big fellow with shoulder length hair and a goatee beard who was about 45 years old, 6' 5" tall, 300 pounds and bald. I believe he may have been referred to by the name ROYAL.

There did not seem to be any organized activity in progress. Most of the people were just more or less milling around and talking with each other. Most were carrying pistols and most were shooting muzzle loading weapons at one time or another.

While I was there, I got to talking to SAM DAVIS about HOWARD CLARK who lives at Ramona. DAVIS stated he felt he could trust CLARK completely and backed this up saying that CLARK is storing some weapons for him. DAVIS said he had also been working on some machine guns with CLARK at Ramona at one time and ~~added that CLARK can get all of the TNT and C-4 plastic explosives he wants.~~ DAVIS said he would get a list of prices of this stuff ~~from CLARK~~ on February 25, 1971, and added that he, DAVIS, has to go to court that morning to answer charges on three traffic warrants.

DAVIS also told me he will be going up to Mud River, Idaho, sometime in the early part of this summer with several other people to live. He said he will give me his address there when it becomes available to him as he wants to stay in touch with me. It appears this may be a Minutemen commune he has been talking about starting for several months now.

*Davis*

Date prepared

1/29/71

Date received

1/26/71

Received from (name or symbol number)

[Redacted]

Received by

SA Steven H. Christen

Method of delivery (check appropriate blocks)

in person  by telephone  by mail  orally  recording device  written by Informant

If orally furnished and reduced to writing by Agent:

Date

Dictated \_\_\_\_\_ to \_\_\_\_\_

Transcribed \_\_\_\_\_

Authenticated by Informant \_\_\_\_\_

Date of Report

1/26/71

Date(s) of activity

1/26/71

Brief description of activity or material

Info re possible BPP named Maury (LNU) + MM activities

File where original is located if not attached

170-286A

\* INDIVIDUALS DESIGNATED BY AN ASTERISK (\*) ONLY ATTENDED A MEETING AND DID NOT ACTIVELY PARTICIPATE. VIOLENCE OR REVOLUTIONARY ACTIVITIES WERE NOT DISCUSSED.

Information recorded on a card index by \_\_\_\_\_ on date \_\_\_\_\_

Remarks:

157-1798 (MM) Index: Bob Sisk  
170-286A-7  
100-14293 (Clay)  
52-4723 (Albert McGill)  
100-14297 (Davis)  
157- (Maury (LNU) open and assign)

170-286A-7/

SEARCHED [Block Stamp] SERIALIZED FILED  
FEB 1 1971  
FBI - SAN DIEGO  
[Signature]

ON JANUARY 26, 1971, BY JEROME

This morning I answered an ad in the newspaper and purchased a .22 calibre Remington rifle for \$20.00. I bought the gun from a Negro individual by the name of MAURY (ph) (LNU) who is presently residing at 5880 University, Apartment #9. He looked to me to be in his late 20's, about 5' 9" tall and slender and was wearing a goatee beard and a moustache. He wore his hair in a modified Afro style and resembled comedian BILL COSBY very much, both in physical appearance and mannerisms.

He told me he had just moved to San Diego from Los Angeles and is looking for work.

While I was at his apartment, I noticed he had large quantities of Black Panther and other black militant literature, including books by ELDRIDGE CLEAVER and copies of the Black Panther Party newspaper.

In addition to the .22 calibre rifle, he also had in his possession a .32 calibre automatic pistol which is a cheap imitation of the French MAB and is made in Spain.

It has been learned that there is a San Diego Police Department officer named BOB SISK who claims he is a member of the Minutemen organization.

I was in contact with GILBERT MC GILL Sunday. He is still employed at the Telephone Company. He told me he has been helping to tap some telephone lines and that it is still a common practice for Telephone Company employees to listen in on telephone conversations in the San Diego area.

Regarding the possibility of a big Minutemen meeting during the middle of December, 1970, I was unable to get in touch with BILL CLAY during almost the entire last half of December and it is possible he may have gone to the Chicago meeting. It is also possible that SAM DAVIS may have gone as I am frequently unable to contact him for several days at a time.

*Jerome*

Memorandum

TO : SAC, SAN DIEGO (170-286 A)

DATE: 2/12/71

FROM : SA STEVEN L. CHRISTENSEN

SUBJECT: ~~\_\_\_\_\_~~ \*

On 2/11/71, source observed a rally on the San Diego State College campus which began at 11:00 a.m., with a meeting on the library lawn. Following this, between 500 and 1,000 students marched across the campus chanting slogans against the current military operations in Laos.

Source said following the march the rally continued with a skit put on by a group known as the Chicano Guerilla Theatre. Following this a young male individuals named "SKIP" who said he was from MDM, spoke to the crowd urging them to harass the Marine Corps at Camp Pendleton, California, during the upcoming courts martial of two MDM members there.

Following this a young girl got up and announced there would be a meeting Sunday evening, 2/14/71, to plan for a big rally on San Diego State College campus Wednesday, 2/17/71. She indicated that persons desiring to attend the meeting should gather "down by the trees" and from there they would march to the meeting place.

She further stated that an additional purpose of the meeting would be to organize a new radical group on the San Diego State College campus which would cover all issues rather than having several organizations each interested in only one specific issue.

- 1 - 170-286 A
- 1 - 100-14528 (STAG)
- 1 - 100-14892 (MDM)
- 1 - 25- (HARASSMENT OF LOCAL SELECTIVE SERVICE SYSTEM 2/16/71 - 2/19/71)
- 1 - 100-13847 (SMC)
- 1 - 62-2008 (COM)
- 1 - 100-14495 (STANCLIFF)
- 1 - 100-15337 (STARSKEY)
- 1 - 100- (HARRY RUJA)
- 1 - 100-14733 (GULLEY)
- 1 - 100-14646 (STANCLIFF)
- 1 - 100-15507 (STEVE NYSTROM)
- 1 - 100-14720 (WOMENS LIB)

SLC/gak  
(13) gak

*[Handwritten signature]*

170-286A-72

SEARCHED _____	INDEXED _____
SERIALIZED _____	FILED _____
FEB 16 1971	
FBI - SAN DIEGO	

Buy U.S. Savings Bonds Regularly on the Payroll Savings Plan

SD 170-286 A

Source also learned there was to be a closed meeting at 3:00 p.m., on 2/11/71, to plan for the Sunday evening meeting.

Following this the microphone was opened to the audience but only one individual, a young male individual with long hair and wearing no shirt or shoes, took advantage of the opportunity. He spoke against carrying the Viet Cong flag and against trying to destroy the system saying he believed the necessary changes could be made within the established frame work. He was not too well received.

Source also acquired a leaflet distributed by members of the Student Mobilization Committee (SMC) at the University of California at San Diego (UCSD). The leaflet called for a massive demonstration against the local draft board office on Park Boulevard and starting with a "mass-in" at the local board building at 10:00 a.m., on 2/16/71.

The leaflet indicated that persons interested in participating should assemble in the Urey Hall parking lot at UCSD at 9:15 a.m., on 2/16/71. Other persons desiring to attend should find their own transportation. For further information interested persons were requested to call telephone number 453-3362.

The leaflet stated that SMC desired to obtain the signatures of enough people so that during the period 2/16/71 - 2/19/71, 20 persons per hour could be assigned to be present at the draft board for harassment purposes.

The leaflet indicated that there are many legal forms of harassment which should be engaged in such as bringing any kind of garbage or miscellaneous articles to be filed in a registrant's folder as Selective Service law states that a registrant may place anything in his folder which he feels is pertinent to his draft status.

SD 170-286 A

The leaflet urged registrants to appear at the draft board simply to examine their file, or to ask any of a number of questions regarding their draft status or the Selective Service System itself.

The leaflet urged females to appear at the draft board and demand to be allowed to register for the draft denouncing the Selective Service System as sexist and racist or to flood the place with tears asking that their boy friends, brothers, etc., be exempted from the draft.

The leaflet also urged interested persons to deluge the draft board with letters requiring file searches and return correspondence in an effort to tie up the system. It pointed out that females by using their first initial and last name could request information from their non-existent files without being traced.

In addition, the leaflet urged persons to tie up the draft board telephone lines with many miscellaneous telephone calls.

Also obtained was a leaflet requesting help and support in the case of SAMUEL C. MILLER, a prisoner in the brig at the 32nd Street Naval Station. The leaflet was issued by Concerned Officers Movement and indicated the group has a house at 3788 Tenth Street, San Diego, California, telephone number 291-4062.

Source also obtained a leaflet indicating there will be some kind of a "teach-in" on the war in Southeast Asia with news film clips and other material at San Diego State College on 2/11/71 and 2/16/71, at 7:00 p.m.



SD 170-286 A

Source recognized the following persons present at the rally:

ALAN STANCLIFF

MORRIS STARSKEY (possibly)  
(Source noted STARSKEY has a new office in the East Wing of the new library Room 529, telephone 286-5549)

HARRY RUJA

GARY GULLEY

CONNIE STANCLIFF

B. J. BYSTROM

A girl named "PAT" from  
Womens Liberation

NEW

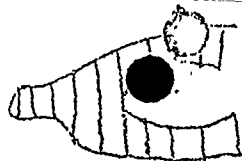

CONSENT (the latest

fad sweeping America  
(Colleges and U's.)

In response to the escalation of the war into Laos the UCSD Student Mobilization Committee is planning a non-violent disruption of the San Diego Draft Board for the entire week of Feb. 16-19 (Tuesday to Friday). This action will be legal but effectively limit business as usual. Suddenly the draft board will be invaded by hundreds of people, gravely concerned about their draft status or the draft status of their loved ones. Some of the methods we suggest are:

1. Ask to see your files.
2. Ask to make appointments to see your files.
3. Bring in anything you feel is pertinent to your case. This might include such things as a statement of your feelings about the war, a roll of toilet paper, a dead fish, a marble. The board is required to accept and file all data you feel is pertinent to your draft status.
4. Women can do several things; they can insist they want to register, for example, proclaiming the army a sexist institution or they can tearfully ask the board to spare their boyfriends.

We will make use of the draft board's bureaucracy to shut it down. This method has been tried successfully in New York and several other Eastern cities.

TUESDAY FEBRUARY 16 MASS AT THE DRAFT BOARD AT 10:30. The address is 3757 Park Boulevard - 1/2 block south of the Capri Theater at Park and University. Wednesday through Friday the action will continue and UCSD SMC is planning to have at least 20 people per hour at the draft board. UCSD volunteers should sign up for hours on these three days at the table on Revelle Plaza to ensure effectiveness. Students from other campuses should come whenever they have available time; EVERYONE SHOULD BE THERE TUESDAY.

If you are not able to come, there are other ways of interfering with the draft board. Take a 6c stamp, put it in an envelope addressed to the Selective Service System (preferably without your name) say hello, send coupons, send more toilet paper. Better yet, if you're a woman, write a letter asking for information about your file and sign this with your first initial only and last name (e.g. T. Nixon). You cannot be traced, you will cause at least minimum interruption as they search for your file. Most important: if you have a dime call the draft board next week at 293-5180 and talk about anything you want (Is this the zoo? Is my mommy here?) Call a lot. Tie the phones up next week while we tie the offices up. Enjoy yourself, be creative!

People from UCSD going to the Tuesday action should assemble at 9:15 in the Urey Hall Parking lot. Bring a car if you can. Anyone who can offer transportation to the draft board during the rest of the week please sign up at the table in Revelle and we will refer riders to you.

For any questions or information that would be helpful to us please call 453-3362 (UCSD Information Center). Remember: TUESDAY FEBRUARY 16 AT THE DRAFT BOARD. BEING A FRIEND.

# each-in On the War

ATTEND THE FAR OUT FREE FLICKS

ON DICK'S WAR, HERE AND THERE!

NEWSREEL FILM PRODUCTIONS PRESENTS:

AmeriKa: Chicago, 1968; Stop the Draft Week; and the Black Lib. Struggle.

People's War: The latest, most comprehensive documentary of the Vietnamese People's daily struggle.

ALSO SPEAKERS AND DISCUSSIONS

Thursday February 11, 7:00 P.M. SSI00

Tuesday February 12, 7:00 P.M. SSI00

The United States is escalating the war in South East Asia. Troops have moved into Laos and Cambodia, the bombing increases, and U.S. commandos attack inside North Vietnam. The administration's long term plans call for replacing U.S. soldiers with mercenaries, and automating the war with more planes, bombs, and perhaps even "tactical" nuclear weapons. Through all this the people of Cambodia, Laos, and Vietnam hold firm, continuing to fight courageously against U.S. domination.

At home, we are beginning to realize that a government guilty of GENOCIDE and ECOIDE in South East Asia cannot permit "liberty and justice for all".

The people of Indo-China need our continuing support. By getting our schools and our communities together, we can best aid their liberation and our own.

## More War

+

## No Classes

# FOR WOMEN'S CONFERENCE

FEBRUARY 12 & 13  
AT THE YWCA 1012 C STREET, SAN DIEGO

The first women's conference in San Diego will bring together women interested in sharing ideas concerning our secondary position in society, and in formulating actions and organization to change this. A proposal for the establishment of a San Diego Women's Center, as one step in this direction, will be discussed.

All women are invited to attend and participate. Child care, housing and transportation will be provided.

## SCHEDULE

### FRIDAY, FEB. 12

- 9---Introduction
- 10--"What is Women's Liberation"
- 12--Lunch, bring your own
- 1---Margaret Wright, speaker on "Sexism and Racism"
- 2---Film, discussion groups
- 3:30-Break
- 4---Workshops I
- 6---Dinner, pot luck, bring a dish!
- 7:30
- 9. Workshops II

### SATURDAY, FEB. 13

- 10---Women's Center, discussion on proposals
- 12---Lunch, bring your own
- 1----Wrap up, on Women's Center and proposals from workshops
- 3----Plans for action, e.g. International Women's Day
- 6----Dinner, Celebration, film, music, a time to relax!

### WORKSHOPS

The workshops will deal with WOMEN and their relation to child care, abortion, work, the war, history, psychology, welfare, marriage and the family, rap groups, politics and as Woman identified Woman, Black and Brown Women, High School Women, and consumers.

For further information or transportation call: 286-6524 or 286-6509. If you plan to use child care facilities at conference, please call 453-1518.

BY STEP, LIE BY LIE  
THE NEW  
ESCALATION

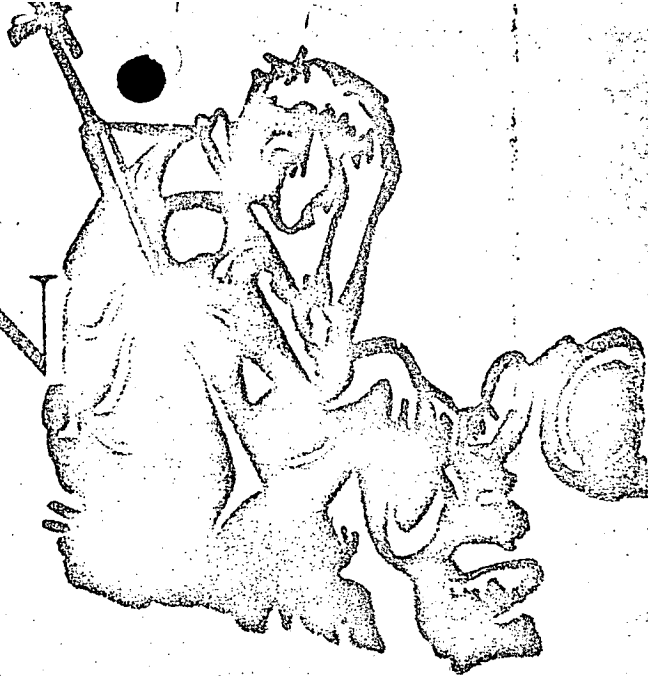

HANDS OFF LAOS!

The government has been telling you the troops are coming home and its a lie. They are escalating and the news is so bad that nothing is being released. The people of Laos are suffering: 800 raids by plane per day - Laos is the most bombed country in the world! - one fourth of the population are refugees from American bombing.

Our campus is directly supporting the war via: ROTC - NEL - the recruitment of students on campus by corporations that profit and survive on the war.

In view of this crisis, let us unite in a peaceful, legal, protest.

MASSIVE DEMONSTRATION AND RALLY

THURSDAY 11:00

Rally on Old Library Lawn 11:00

March across campus 11:30

Rally in Aztec Center 12:00

OUR SISTERS AND BROTHERS IN S.E. ASIA ARE COUNTING ON US. WE MUST ACT NOW!

U.S. OUT OF ASIA

Samuel C. Miller prisoner in the 32nd Street 418.

- Sam Miller is a conscientious objector.
- Sam Miller has written: By lending my support to the military, I also become responsible to God for those major actions of the military. Therefore I have been forced to accept the responsibility of war and death. This responsibility I can no longer accept. A Christian citizen must be responsible to both man and God, what he may not do is obey men rather than God, or overlook the degree of compromise in our best acts, or gloss over the sinfulness of war.

- A Navy Chaplain writes: Sam Miller is a sincere, devout Christian. He is regular in his attendance of Divine Worship and gives every expression of following the teachings of Christ.

His minister writes: His beliefs are well grounded in the church and Bible and his actions have been true to his beliefs. I have no hesitation in submitting this letter declaring the credibility of Mr. Miller's decision for release from military involvement due to religious beliefs.

The Navy Times, Jan 20, 71: Military officers have a hard time being judicial about these claims, ... because "the notion is widely held that conscientious objectors are at best cowardly and at worst subversives."

Department of Defense Directive 1300.6 (VI. A.1) Employ the person (conscientious objector) in duties which involve the minimum practicable conflict with his asserted beliefs pending investigation and decision on the case.

THIS CASE HAS NOT EVEN BEEN DECIDED UPON BY THE NAVY

Under orders to Southeast Asia for the second time, Sam Miller wrote, "Such participation in this ship's movement would be in direct conflict with my asserted beliefs."

SAM MILLER did the only thing he could do in conscience, he refused to go. He never went UA. He was convicted before a General Court Martial of Missing Movement. Results:

1. Nine months confinement at hard labor. (8 mos to go)
2. Total forfeiture of pay.
3. Reduction in rate from E-5 to E-1.
4. A Bad Conduct Discharge from the Service.

THE NAVY HAS STILL NOT PASSED JUDGMENT ON HIS CONSCIENTIOUS OBJECTOR CLAIM (as of 10 February 1971)

OVER OVER OVER OVER

SAC, SAN DIEGO (157-28)

2/12/71

SA STEVEN L. CHRISTENSEN

NATIONAL SOCIALIST WHITE PEOPLE'S PARTY  
RACIAL MATTER

On 2/4/71, *CONF. SOURCE*

, made available the attached information regarding activities of captioned organization.

It is noted that the attached material indicates that MATT COLE or KAHLE, National Commander of captioned organization, is expected to be in the San Diego, California area on 2/14/71, for the purpose of recruiting and organizing for his organization at San Diego.

On 2/11/71, ~~XXXXXX~~ was contacted regarding the attached material and advised he is unfamiliar with any of the individuals involved but stated if COLE does come to the San Diego area, he will in all likelihood contact VIC WALTON or JOE BRINKER.

Informant stated that VIC WALTON has fallen into disfavor with many local right wing individuals as he has apparently sold some of them down the river in court cases. He said there has even been some talk about killing WALTON.

- 2 - 157-28
- ① - 170-286 A
- 1 - 100-14303 (VIC WALTON)
- 1 - 100-14292 (JOE BRINKER)

SLC/gak  
(5) *gak*

170-286A-73

SEARCHED	INDEXED
SERIALIZED	FILED
FEB 16 1971	
FBI - SAN DIEGO	

Date prepared

2/24/71

Date received

2/4/71

Received from (name or symbol number)

[Redacted] \*

Received by

SA Steven L. Christensen

Method of delivery (check appropriate blocks)

in person  by telephone  by mail  orally  recording device  written by Informant

If orally furnished and reduced to writing by Agent:

Date

Dictated

2/19/71 to G. Kennedy

Transcribed

2/23/71

Authenticated by Informant

2/24/71

Date of Report

2/4/71

Date(s) of activity

2/4/71

Brief description of activity or material

Note received at MM POB - activities of Davis, Forrest, Hoover, Willis -

File where original is located if not attached

\* INDIVIDUALS DESIGNATED BY AN ASTERISK (\*) ONLY ATTENDED A MEETING AND DID NOT ACTIVELY PARTICIPATE. VIOLENCE OR REVOLUTIONARY ACTIVITIES WERE NOT DISCUSSED.

Information recorded on a card index by \_\_\_\_\_ on date \_\_\_\_\_

Remarks:

- 157-1798 (MM)
- 170-286A-74
- 157-2224 (Isaac Cantrell)
- 157-2178 (Dominic)
- 157-217 (Tom Forrest)
- 100-14297 (Davis)
- 100-15356 (Hoover)
- 100-15666 (Roger Willis)

170-286A-74 Block Stamp

SEARCHED \_\_\_\_\_ INDEXED \_\_\_\_\_  
 SERIALIZED \_\_\_\_\_ FILED \_\_\_\_\_  
 FEB 28 1971  
 FBI - SAN DIEGO  
 [Signature]



On February 4, 1971  
By JEROME

Today I checked the Minutemen Post Office Box at Spring Valley, California, and found a letter addressed to AFSC. The person sending the letter used regular Minutemen precautions in sending it, such as double wrapping the message.

The message itself was written on a two inch by four inch piece of paper in grease pencil and said, "Make contact February 7, 7:00 a.m., 445-9570". This looks very interesting and I plan to go ahead and make the contact as requested on the note.

I have learned recently that SAM DAVIS and TOM FORREST have been doing a lot of business together for some time. The name RONALD TIMOTHY DOMENICK or DOMINIC is not familiar to me but the name "PAUL" and the description you gave me sounds like an individual who hangs around with FORREST and some of the other gun people.

I also have heard a rumor before that FORREST is operating some kind of a shop on the Mexican boarder and FORREST allegedly deals in a lot of illegal stuff.

FORREST has had two large boats and lost both of them. There is a story around which I believe is probably true that his second boat was bombed as a result of a quarrel or something over smuggling. I have never heard anything about him having any hand grenades on the boat but he may have had some kind of high explosives on it.

With regard to the Gun Smoke Ranch being for sale, it is my understanding that all of the people at the ranch including DAVIS, HOOVER, WILLIS and several others will eventually be going to the Mud River, Idaho, area.

*Jerome*

On February 4, 1971  
By JEROME

Note:

On February 5, 1971, it was determined that telephone number 445-9570 is a public pay telephone located in the front of a liquor and grocery store at 2262 Highway 80 by Alpine, California. The location of this telephone number was furnished to informant so that he might have it watched in an effort to determine the individual's identity he would be contacting.

*Jerome*

Date prepared  
2/24/71

Date received  
2/8/71

Received from (name or symbol number)  
~~XXXXXXXXXX~~\*

Received by  
SA Steven L. Christensen

Method of delivery (check appropriate blocks)  
 in person  by telephone  by mail  orally  recording device  written by Informant

If orally furnished and reduced to writing by Agent:  
Date  
Dictated 2/19/71 to J. Kemery  
Transcribed 2/23/71  
Authenticated by Informant 2/24/71

Date of Report  
2/8/71

Date(s) of activity  
2/9/71

Brief description of activity or material  
Contact w/ Isaac Cantrell, Sam  
Davis, Paul Hunt at L.A.

File where original is located if not attached

\* INDIVIDUALS DESIGNATED BY AN ASTERISK (\*) ONLY ATTENDED A MEETING AND DID NOT ACTIVELY PARTICIPATE. VIOLENCE OR REVOLUTIONARY ACTIVITIES WERE NOT DISCUSSED.  
 Information recorded on a card index by \_\_\_\_\_ on date \_\_\_\_\_

Remarks:  
157-1798 (MM)  
~~170-286A-15~~  
157-2224 (Cantrell)  
157-14015  
100-14016 (Houghton)  
100-157-1820 (Yacopiec)  
100-14297 (Davis)  
100-14015 (Houghton)  
100-14293 (Clay)  
~~100-157-2177~~ (Forrest)  
3 - Los Angeles  
(1 - Paul Hunt)  
(1 - Dennis Mower)  
Index: Paul Hunt,  
157-242 Dennis Mower  
Black Stamp 157-242-75  
SEARCHED INDEXED  
SERIALIZED FILED  
FEB 26 1971  
FBI - SAN DIEGO

On February 8, 1971  
By JEROME

Yesterday at 7:00 a.m., I contacted the individual who sent the note in the mail as he had requested. We made arrangements to meet together at the Denny's Restaurant in El Cajon. I plan to have SAM DAVIS or GEORGE HOOVER or both there to watch the meeting and make sure nothing funny happens.

The person I talked to on the telephone gave me what he said was his Minuteman Serial Number. I subsequently checked this number with BETTIE HOUGHTON who said the number is a good one and falls within a block of numbers which she said she knows was legitimately issued. She said she has access to some files which may include this number so that possibly she can find out who the person is.

While I was making the call I had FRANK YACOPEC watching the telephone booth up at Alpine. FRANK pretended to have a flat tire by stopping about a half a mile down the road from the telephone booth where he let some air out of one of his tires. He then drove his car to an air pump at a service station near the telephone booth where he was able to watch the person who received the call. After the call was over he followed this individual to a side street named Marshall Road. When he got to the road and looked the person had disappeared. He said there were only two cars on the road which looked like they had been driven recently which had the following license plate numbers:

WAB 703

and

YCB 714

I also had a long talk with SAM DAVIS today and obtained the following information:

*Jerome*

On February 8, 1971  
By JEROME

He said that one PAUL HUNT at Santa Monica, California, is the person who is actually in charge of the Minutemen in the State of California or at least in that area and he has been so in charge since the disappearance of TROY HOUGHTON. He added that DENNIS MOWER is only a public figurehead and added that he thinks PAUL HUNT is a very dangerous man.

On the subject of TROY HOUGHTON, I have learned from both DAVIS and BILL CLAY that HOUGHTON's contacts may have been much more widely spread than I thought. Specifically, they told me that HOUGHTON was behind an attempt several years ago by 18 "hunters" in the State of New York to conduct sabotage and terrorist attacks on New Left Groups. These 18 individuals were supposedly arrested and a large quantity of weapons and ammunition was confiscated.

I also talked some more with DAVIS about TOM FORREST and it appears that they know each other extremely well. DAVIS said he had some business dealings with FORREST involving some machine guns and other items.

DAVIS apparently has decided not to get rid of as much of his explosives and so forth as he originally said. He has a small quantity of T.N.T. and also some C4 Plastic explosives which he will sell at \$10 a pound which is too high a price.

He said he can also obtain a military weapon which is like a bazooka and has a self-contained 3.5" rocket round in an expendable launcher. He said the price of this is \$25.

*Jerome*

185-10218

✓

SSC Request 1/20/76  
Item 2 (Re: Howard Berry Godfrey)  
Volume II

Access

SSC Request 1/20/76  
Item 2 (Re: Howard Berry Godfrey)  
Volume II

Retain



Date: 1. 10. 77

Mark opposite each item number of the serial or serials in which the information appears. Although these items are regarded as nonvariable, changes be noted by adding the new serial number and crossing out the old. When form is complete as to all applicable items, the Agent and Field Supervisor should initial the form at the end.

Symbol Number: 155-RE Office File: 155-256

Type of Informant:  Prob  Regular  Ghetto  CS Bureau File: 157-17737

	Serial Number
1. Name	
2. Aliases	157-1643-24
3. Symbol Number assigned and Bureau advised	
4. Cover name assigned and Bureau advised	
5. Background developed	
6. Personal history, as required in Sec. 130D, 2c, Vol. IV, M. of I.	
7. Description	
8. Photograph	In 157 file
9. Credit check	1/6/72
10. Local criminal check	1/6/72
11. Bureau Identification Record (FD-9)	157-1643-6
12. Selective Service check	
13. Armed Service record check	
14. Informants canvassed	
15. Past racial activities	
16. Racial associates	None
17. Informant advised of:	
(a) Not Bureau employee	157-1643-24
(b) Activities voluntary	157-1643-14
(c) Relationship confidential	157-1643-74
(d) FBI jurisdiction	157-1643-14
(e) Furnish information only to Bureau	157-1643-24
(f) Payments are income	157-1643-24
(g) Report to be submitted under code name and in third person	157-1643-74
(h) Not to contact office personally	157-1643-24
(i) Not to retain copies of notes or reports	157-1643-24
18. Reliability check	
19. Statement of cooperation	
20. When removed from probation	2/11/75
21. Informant indices card made	2/11/75
22. Agent who handles informant	1. 108
23. Alternate Agent	15
24. Flash notice placed	157-1643-21 2/15 or removed
25. Coverage	
Completed	
Approved	

Keep on Top of Other Serials in File.   
 1/5  
 R/S to complete  
 FD-577  
 W

Date prep

2/11/75

Date received

2/4/75

Received from (name or symbol number)

Submittal

Received by

SA Earl in Betts

Method of delivery (check appropriate blocks)

in person

by telephone

by mail

orally

recording device

written by Informant

If orally furnished and reduced to writing by Agent:

Date

Date of Report

2/11/75

Dictated

to

Date(s) of activity

1/17/75

1/31/75

Transcribed

Authenticated by Informant

2/11/75

Brief description of activity or material

File where original is located if not attached

170-512A

~~Informants: Ron Eddy & George Mitchell~~  
~~Horn~~

\* INDIVIDUALS DESIGNATED BY AN ASTERISK (\*) ONLY ATTENDED A MEETING AND DID NOT ACTIVELY PARTICIPATE. VIOLENCE OR REVOLUTIONARY ACTIVITIES WERE NOT DISCUSSED.

Information recorded on a card index by

on date

Remarks:

- 1-110-512A - 366
- 1-157-152 (Ron Eddy)
- 1-157-3487 (Dennis Low)
- 1-157-2898 (Thomas F. Knight)
- 1-157-2610 (Mickey Wakefield)
- 1-157-2545 (Ray Wilson)
- 1-157-201 (Herald Smith)

Not germane to Godfrey

- ① 170-286 (Godfrey)
- 1-157-3087 (Joe Drisker)
- 1-157-4557 (Tom Metzger)
- 1-157-4597 (NCC)
- 1-157-3017 (George Horn)
- 1-157-2815 (SAO)

Not germane to Godfrey

EM P: 26  
(13)

Block Stamp

170-286-167

SEARCHED	INDEXED
SERIALIZED	FILED
FEB 19 1975	
FBI - SAN DIEGO	

102

It has been ascertained that at this time Ron Eddy of Poway is not interested in trying to form or lead any type of security force for any right-wing extremist group. When asked by James K. Warner of Los Angeles (via Dennis Loso of Escondido) if he would do this, Eddy stated that he would like to see the formation of a Security Force with teeth in it but does not consider himself to be enough of a leader to do it himself.

While declining to lead a Security Force, Eddy did say that the only way to stop FBI infiltration of rightist groups would be for one of the infiltrators to "wind up in the river" someday. Eddy is positive that Tom Knight's San Diego unit of the Nazi Party has a regular FBI infiltrator. The only three men of whom he is not suspicious are Mickey Wakefield, Ray Wilson and Gerald Smith. Said Eddy, "Those three men dropped out of the thing and so I figure they're okay but you can bet that the fink is still in there pushing".

Loso said that the whereabouts of people like Barry Godfrey should be learned and they should be telephoned and intimidated. Eddy said he thinks such intimidations would be a waste of time and that people like Godfrey should be killed. Mickey Wakefield of San Marcos went along with Eddy's suggestion. Ron Eddy also mentioned having had an encounter with an FBI agent named Peterson in San Diego but did not elaborate.

Eddy firmly believes that any man who commits himself to one organization in the Far Right should not be involved with others. He says he would be very suspicious of anyone who is. He is also somewhat suspicious of Tom Knight. He says that Joe Brinker gave Knight the name of a man interested in Nazism and two weeks later the FBI interviewed the man. Also, Eddy wonders how Knight saved his federal job in the face of his continued Nazi activities. Eddy feels that any regular rightist extremist who stays on with the Nazi Party now must warrant heavy suspicion of being an FBI informant.

On Friday night, January 31, 1975 Ron Eddy met Tom Metzger of Fallbrook for the first time. Metzger showed Eddy some pictures and slides of New Christian Crusade activities and the two seemed to hit it off pretty well. Metzger told Eddy, Wakefield and Loso of a visit he received at his home on January 17, 1975 from agents of the Internal Revenue Service. He said the agents were nervous.

*Handwritten signature*  
2F1-7

George Mitchell Hoover

Here is one last bit of information. The New Christian Crusade people are very concerned about the imprisonment of George Hoover of the Secret Army Organization. At one of their banquets the NCC had four unoccupied places set at the table which were in honor of four men whom they hold to be absent heroes. These four men were Joe McCarthy, George Hoover, Charles Lindbergh and a man named R. Miles.

Anyway, it has been learned that a man whom Tom Metzger knows is going to take a dossier of the Hoover case to some congressman in Washington, D.C. who is part of a committee currently scheduled to investigate the FBI. The dossier consists of newspaper clippings and other material pertaining to Hoover's activities in the SAO, his arrest, conviction, appeal, etc. They are hoping to stir up a big publicity stink to give the FBI a bad name due to Barry Godfrey's activities and in so doing hope to effect an eventual release of Hoover from prison. By the way, the NCC people do not refer to Hoover by his correct name. For some reason they all call him Mickey Hoover.

That is about all for now. I hope this will be of some help to you.

*Handman 2-1-75*  
*1 Informant*

DIEGO

(Mount Clipping in Space Below)

# - FBI behind right-wing "army"?

# Militants here say they were spying victims

(Indicate page, name of newspaper, city and state.)

La Jolla - University  
SENTINEL  
Wed 1/15/75

(First of two parts)  
by Lynne Carrier

Three years ago, a small band of militant right-wingers calling itself the "Secret Army Organization" declared war on communism.

From its headquarters in El Cajon, the paramilitary group dedicated itself to combatting anti-war protesters and "leftists."

But a \$10.6 million civil rights damage suit filed in behalf of two San Diego militants charges the SAO wasn't acting entirely on its own.

The suit, handled by the American Civil Liberties Union (ACLU), contends the organization during its eight months of extremist activities.

Peter Bohmer, former assistant economics professor at San Diego State

University, and co-plaintiff Paula Tharp say that because of their leftist political beliefs they were the target of bodily and professional injury, acts of terrorism and harassment by right-wingers led by a paid FBI informer.

They also claim law enforcement officials failed to protect them and on occasion harassed the plaintiffs.

Although the incidents happened in San Diego, Bohmer and Tharp maintain their woes stemmed from ex-President Nixon's domestic counterintelligence policies of the late '60s and early '70s.

To prove that, the suit names 58 defendants, ranging from Nixon to the cop on the beat.

The list includes a galaxy of Watergate villains — John Mitchell, H. R. Haldeman, John Erlichman, Charles

CC no 62-2248 (SUIT)  
& 157-2415 (SAO)

Being Investigated

180-286-166

SEARCHED	INDEXED
SERIALIZED	FILED
FEB 11 1975	
FBI—SAN DIEGO	

mentioned are officials, White House staff members present and past CIA chiefs.

"So far as we know, this is the first case implicating the CIA since it was alleged to have conducted domestic surveillance of anti-war protesters," said Bohmer.

County Supervisor Lou Conde, Dist. Atty. Ed Miller, Police Chief Ray Hoobler and other policemen also made the defendants' list.

Commenting on the number of defendants named, Logan McKechnie, spokesman for the district attorney's office, noted, "It's totally unwieldy. How will they ever get the case to court?"

McKechnie questioned whether the

could be proven. Among numerous allegations in the suit, Bohmer and Miss Tharp are charging:

—The FBI funneled money into the SAO with full knowledge the members were violence-prone and committed to disrupting and harassing anyone it labeled as "Communist."

—After several death threats against Bohmer, Miss Tharp was shot in the elbow by an SAO gunman firing into Bohmer's house.

—FBI agent Steve Christiansen kept the weapon used to shoot Miss Tharp in his home for six months before revealing the FBI knew the identity of the gunman.

—Despite their requests for  
(See SECRET ARMY, 4A)

## ~~Secret army~~

(Continued from 1A)

protection, the plaintiffs claim police never took much interest until an SAO member bombed the X-rated Guild Theater while a policeman and a city official were seated in the audience.

—The FBI informant, Howard Barry Godfrey, admitted in court he recruited SAO members and acted as leader of the sole operative SAO unit in the county.

—In early 1972, when the Republican convention was still scheduled for San Diego, "dirty tricks" specialist Donald Segretti asked the San Diegans to infiltrate the Republican Convention Coalition, a "new left" group.

—Segretti also met with Godfrey and other SAO members at the Gunsmoke Ranch in El Cajon.

—Conde supplied equipment and money to the SAO and its predecessor, the Minutemen, between 1967-72.

—While a paid informant in the Minutemen, Godfrey and his cohorts broke into the offices of an underground

newspaper, the Street Journal, and destroyed equipment and subscription records.

Bohmer further complained of his arrest and conviction in 1972, stemming from charges related to his role in a protest demonstration during which protesters threw ties on a railroad track. He said police hired Wayne McCracken, an informer, to infiltrate his committee.

Godfrey was forced to spill the beans when Rubien Brandon, a police detective, and Hoobler pressured the FBI to identify its FBI informer after the theater bombing.

The informant's testimony put two SAO members — William Francis Yakopec and George Hoover — behind bars.

Yakopec was convicted of bombing the Guild Theater and got a six months to life sentence.

Hoover, whose conviction was recently upheld by the State Supreme Court, is serving five years to life for shooting into Bohmer's house and wounding Miss Tharp.

Other alleged SAO members were charged with offenses ranging from firearm and explosive violations to perjury for denying membership in the paramilitary group. The SAO, whose ranks apparently never totaled more than 30, disintegrated.

His cover blown, Godfrey folded his tent and moved to Sacramento where he is now employed by the fire department there. His FBI contact, Steve Christiansen, left the agency when Godfrey went public with the SAO story. He is presently a store manager in Kenosh, Utah.

On one point, leftists and SAO defendants agree — the full story hasn't been told.

According to Frederick Hetter of San Ysidro, who was the attorney for Yakopec and SAO state coordinator Jerry Lynn Davis, the FBI apparently limited its agents' responses to carefully screened written questions.

He said the FBI invoked "executive privilege" on the grounds federal agents aren't supposed to testify in state trials.

Hetter, who said his SAO clients may have been unwitting pawns of Godfrey and the FBI, claimed he was unable to get hold of FBI documents crucial to Yakopec's defense.

"We just couldn't get our hands on the stuff," he said. "And that information was the heart of our defense."

Rex Schroeder, head of the FBI office here, said the FBI did cooperate during the SAO trials, adding, "There's never enough information for defense attorneys."

Schroeder said he hasn't reviewed the Bohmer-Tharp lawsuit yet.

As for Bohmer and ACLU lawyer, Rosenbaum, they admit the FBI role in the SAO may give SAO defendants grounds for filing their own civil rights suit. But, generally, they weren't sympathetic towards their ideological adversaries.

Bohmer wryly noted that on one score he did end up on the same side of the fence with the SAO:

\*\*\*

(Next: The FBI and the SAO.)

(Mount Clipping in Space Below)

# FBI informant's role challenged

# Lawsuit fingers the spy next door

(Indicate page, name of newspaper, city and state.)

*La Jolla - University  
Sentinel  
1/19/75*

by Lynne Carrier

(Second of two parts)

He is soft-spoken, bespectacled — the kind of man you wouldn't pick out of a crowd.

He was an elder in the Mormon church and held a good job with the Fire Department.

But Howard Barry Godfrey had another identity: he was a spy for the FBI.

And when he came in from the cold 2½ years ago, he told a bizarre tale of

extremist intrigue fit for a Le Carre novel.

Godfrey was an FBI informer in a right-wing organization called the Secret Army Organization (SAO) headquartered in El Cajon.

During a series of trials in September, 1972, his testimony smashed the small paramilitary unit, sending two members to prison and bringing others to trial on a variety of firearms, explosives and perjury charges.

As the star witness for the prosecution, he recounted an SAO history studded with

bombings, shooting and harassment of leftist dissenters and war protesters.

Godfrey was no mere SAO fellow traveler. He headed the only active cell in the county and took part in its hijinks.

There was speculation Godfrey was more an agent provocateur than an informant and that the FBI may have condoned — even encouraged — dirty tricks against radicals.

On that premise, the American Civil Liberties Union (ACLU) has filed a \$10.6 million damage suit in behalf of two local militants. Peter Bohmer and Paula Tharp.

Author:

Editor:

Title:

Character:

or

Classification:

Submitting Office:

Being Investigated



targets of SAO shenanigans.

Ironically, the suit incriminates Godfrey with his own words. He is one of 58 defendants named in the complaint. And much of its 40-page text is based on his court testimony and press interviews.

The ex-informant — now employed at the state fire marshal's headquarters in Sacramento — refused to comment on the ACLU suit.

However, his portrait of domestic espionage and SAO tactics is on the public record.

(See THE SPY, 4A)

## The spy next door

(Continued from 1A)

His history as an FBI infiltrator of the extreme right began in 1967, he said. When first contacted by members of an earlier paramilitary group, the Minutemen, Godfrey said the stake president of his Mormon church put him in touch with the BFI.

Godfrey came aboard as a paid FBI informant, spying and participating in Minutemen activities.

Largely due to former U.S. Atty. Gen. Ramsey Clark's efforts, the FBI cracked down on Minutemen groups all over the country in the late '70s.

The San Diego chapter declined after its local leader, Troy Houghton, vanished mysteriously in 1967.

In October 1971, Godfrey told his FBI contact, Steve Christiansen, a phoenix was rising from the Minutemen ashes — the Secret Army Organization. Christiansen was interested — and Godfrey was back in the informer business.

Every bit as virulent and fanatical as the Minutemen, SAO members were committed to armed resistance of leftist "enemies." Units were active in 11 western states, with San Diego sporting an especially dedicated, if small, group of activists.

Godfrey fingered Jerry Lynn Davis (also known as Capt. Patrick McDonald) as state SAO commander and local coordinator.

Godfrey recruited members making great pretense of concealing their identities. He testified he had nine men in his cell. There was also a 10th man unknown to the other members. It was a dummy number, explained Godfrey, so he could slip an extra set of SAO literature into the FBI files.

Depending on how much information Godfrey supplied, the FBI paid him up to \$250 a month.

Additionally, the FBI reimbursed him for his monthly dues and occasional cash donations to the group.

On learning the FBI had funneled money into the SAO, Jerry Davis commented acidly. "You might say we were a federally funded poverty program of the right."

According to both leftists and lawyers who later defended SAO members, Godfrey had the best of both worlds — he could indulge in paramilitary fun and games while pocketing government money.

Godfrey assisted his SAO subordinates in spreading hate literature attacking leftist sympathizers and pornography. Members of his cell also committed a series of capers that, in two cases, nearly ended in tragedy.

With students organizing protests against the Vietnam War, young radical demonstrators figured near the top of the SAO "enemies" list.

In one interview, Godfrey allegedly claimed the SAO accumulated vast files on local leftists, sometimes by breaking into their homes. Godfrey passed this information on to the FBI.

In late 1971, Peter Bohmer — a former economics instructor at San Diego State and an active war critic — began receiving death threats from the SAO.

An SAO bulletin berating Bohmer listed his address, phone number and description, inviting readers to "stop by and deal with the Red scum."

On another occasion, an anonymous caller left Bohmer a message: "Wish Pete a Merry Christmas. This will be his last. This is the Secret Army Organization."

Other death threats followed.

Finally, on Jan. 6, 1972, two shots were fired through Bohmer's window. His friend, Paula Tharp was wounded in the elbow.

As a result, police began to investigate the SAO.

But the FBI wasn't ready to blow Godfrey's cover.

Six months later, Godfrey admitted he had witnessed the shooting. He told a court he had driven to Bohmer's house in Ocean Beach on a "surveillance" mission. Another SAO member, George M. Hoover, had fired two shots from Godfrey's car and would have fired more if his gun hadn't jammed, said the informant.

Godfrey had then taken the tell-tale pistol and Hoover's jacket to FBI agent Christiansen, who hid the evidence in his home until the SAO was exposed later that year.

The final straw that broke the SAO was the wildcat bombing of the Guild Theater on June 19, 1972. No one was injured in the blast, but Rubien Brandon, a detective on the San Diego police force, and Thorpe Nolan of the city attorney's office, were in the audience apparently reviewing porno films for possible obscenity violations.

After Brandon and Police Chief Ray Hoobler pressured the FBI to reveal its informer's identity, Godfrey soon ascended the witness stand and nailed Davis and other SAO members.

Hoover was charged with shooting into Bohmer's house and Godfrey's neighbor. William Francis Yakopec, was cited as the Guild Theater bomber.

According to Godfrey, Yakopec had long toved with the idea of blowing up porno theaters, adult book stores and massage parlors.

The informer told how Yakopec met him at the fence between their yards, still flushed from his bombing exploit of the previous night.

Godfrey testified Yakopec described " ... the sound, the blast, how the dust hung over the air at the theater ... how he stood down at the end of the block and listened to the blast. He then described to me how he placed the bomb, what type of a bomb he used, and how he carried it down the alley and planted it."

Frederick Hetter, Yakopec's attorney, believed his client might have had grounds for pleading entrapment but the jury found Yakopec guilty anyway.

Godfrey's friendship with the unemployed carpenter began in a gun shop. Soon after, Godfrey encouraged Yakopec to move next door to his El Cajon residence.

Yakopec, a former Minuteman sympathizer, became Godfrey's lieutenant in the SAO. Together, they discussed their mutual hate of pornography and communism and explored their common loves — guns and explosives.

It was Godfrey who sold Yakopec the explosives he used to bomb the Guild Theater. Godfrey said he reported the transaction to the FBI.

But Godfrey maintained he advised his lieutenant "he should bury them and save them for after the Communist takeover."

Deputy Dist. Atty. Richard Huffman, who prosecuted the Yakopec case, said there may be other SAO information in the FBI files. But he criticized the ACLU for wanting to "rummage freely through FBI records."

(Mount Clipping in Space Below)

# Secret Army Organization: Was FBI behind it?

(Indicate page, name of newspaper, city and state.)

## Antiwar protester and leftist dissenters who were the target of the SAO now contend that SAO wasn't acting entirely on its own.

This is the first of two articles on the Secret Army Organization.

By LYNN CARRIER

Three years ago, a small band of gun-toting militant right-wingers, calling itself "The Secret Army Organization" (SAO) declared war on communism.

From its local headquarters in El Cajon, the paramilitary group dedicated itself to wreak terrorism on antiwar protesters and leftist dissenters.

But a \$10.6 million civil rights damage suit filed last week in behalf of two local radicals activists charges that the SAO wasn't acting entirely on its own.

**THE COMPLAINT**, to be handled by the American Civil Liberties Union (ACLU), contends that, during its eight months of extremist activities, the SAO was organized, and financially funded and directed, by the FBI.

Peter Bohmer, former

The men ... maintain their woes stemmed from ex-President Nixon's domestic counter intelligence policies.

assistant economics professor at San Diego State University, and co-plaintiff Paula Tharp, say that because of their leftist political beliefs, they were the target of bodily and professional injury, acts of terrorism and harassment by rightwingers led by a paid FBI informer.

They allege that local law enforcement officials failed to protect them from danger and on occasion also harassed the plaintiffs.

Although the incidents happened in San Diego, Bohmer and Tharp maintain their woes stemmed from ex-President Nixon's domestic counter-intelligence policies of the 1950's and early '70's.

To prove that national connection, the suit names 58

Chula Vista 5798  
NEWS 1/16/75

Date:  
Edition:  
Author:  
Editor:  
Title:

Character:  
or  
Classification:  
Submitting Office:

Being Investigated

170-286-165

SEARCHED	INDEXED
SERIALIZED	FILED
JAN 17 1975	
FBI-SAN DIEGO	

...nt includes a galaxy of  
gate villains — John  
ell, H. R. Haldeman, John  
ichman, Charles Coison,  
don Liddy, Donald Segretti  
E. Howard Hunt, among  
rs.

Also mentioned are FBI ad-  
ministrators and staff, current  
te House staff members, and  
esent and past CIA chiefs.

"SO FAR as we know, this is  
first case implicating the  
A since it was alleged to have  
ducted domestic surveillance  
antiwar protesters," said Boh-  
er.

In San Diego, former SAO  
embers, Supervisor Lou Conde,  
istrict Attorney Ed Miller,  
lice Chief Raymond Hoobler,  
d other law officers made the  
endants' list.

Commenting on the number  
defendants named, Logan  
Kechnie, spokesman for the  
istrict attorney's office, noted,  
s "totally unwieldy. How will

ey ever get the case to court?"

McKechnie questioned  
hether the charges outlined in  
e 40-page suit could be proven.  
owever, Mark Rosenbaum, a  
wyer handling the case from  
e Los Angeles ACLU office,  
ounter that "we didn't in-  
lude any charge that we felt we  
ouldn't prove in a court of law."

ROSENBAUM, who is also  
handling a civil rights suit for  
ctress Jane Fonda, added that  
he Bohmer-Tharp lawsuit is  
important because it should  
'expose the underbelly of  
Watergate" and pressure the  
government to reveal what went

on a grassroots before the  
Watergate scandal broke.

"Everyone has to stop and  
think before he engages in these  
activities," said Rosenbaum of  
law enforcement agents who  
may have violated the civil  
rights of leftists opposing the  
IndoChina War and Nixon's  
governmental policies.

#### AMONG numerous

allegations in the suit, Bohmer  
and Miss Tharp are charging:

— The FBI funneled money  
into the extremist SAO with full  
knowledge the members were  
violence-prone and committed to  
disrupting and harassing anyone  
it labeled a Communist.

— After several death threats  
against Bohmer, Miss Tharp  
was shot in the elbow by an SAO.

gunman firing into Bohmer's  
house.

— FBI agent Steve  
Christiansen kept the weapon  
used in shooting Miss Tharp  
concealed in his home for six  
months before revealing the FBI  
knew the identity of the gunman.

— Despite their requests for  
protection from the SAO, the  
plaintiffs claim the San Diego

police force never took much  
interest until an SAO member  
bombed the x-rated Guild  
Theater while a police officer  
and a city official were seated in  
the audience.

— The FBI's informant in the  
SAO, Howard Barry Godfrey,  
was an agent provocateur, who  
admitted in court testimony he  
had recruited SAO members and  
acted as leader of the sole  
operative SAO unit in the county.

— In 1972, when the  
Republican Convention was still  
scheduled for San Diego, "dirty  
tricks" specialist Donald  
Segretti asked two San Diegans  
to infiltrate the San Diego  
Convention Coalition, a "new  
left" group of government and  
war critics.

— Segretti also met with  
Godfrey and other SAO mem-  
bers at the Gunsmoke Ranch in  
El Cajon.

— County Supervisor Conde  
supplied equipment and money  
to the SAO and its predecessor,  
the Minutemen, between 1967  
and 1972.

— While a paid informant in  
the Minutemen, Godfrey and his  
cohorts broke into the offices of

*So far as we know, this is  
the first case implicating the  
CIA since it was alleged to  
have conducted surveillance*

an underground newspaper, the  
Street Journal and destroyed  
equipment and subscription  
records.

— Disillusioned with Nixon's  
trip to China, the SAO con-  
templated assassinating the  
President by flying a drone into  
his plane when it arrived at the  
Republican Convention in 1972.

— The SAO also considered  
kidnapping or killing leftist  
leaders during the convention  
and spraying protesters on  
Fiesta Island with white  
phosphorus.

— Bohmer further com-  
plained of his arrest and con-  
viction in 1972, stemming from  
charges related to his role in a  
protest demonstration during  
which protesters threw ties on a  
railroad track. He said San  
Diego police hired Wayne Mc-  
Cracken, an informer, to in-  
filtrate his defense committee.

**MUCH OF** the information on SAO activities cited in the suit was based on sworn courtroom testimony supplied by one man — FBI informant Godfrey.

Prior to Godfrey's sensational revelations during a series of SAO trials in 1972, the Secret Army lived up to its name. It was known mainly by its literature, posters and emblems, but its members steered clear of personal publicity. A few people even doubted the group existed.

Godfrey was forced to spill the beans when Rubien Brandon, a detective in the San Diego police department's investigative support unit, and police chief Raymond Hoobler pressured the FBI to identify its

FBI informer after the Guild Theater bombing.

The informant's testimony put two SAO members — William Francis Yakopec and George M. Hoover — behind bars for long terms which they are still serving.

Yakopec was convicted of bombing the Guild Theater and got a six months to life sentence.

Hoover, whose conviction was recently upheld by the state Supreme Court, is serving a five year to life sentence for shooting into Bohmer's house, wounding Miss Tharp and illegal possession of a billy club.

**OTHER ALLEGED SAO** members were charged with offenses ranging from firearm and explosive violations to perjury for denying membership in the paramilitary group. The SAO, whose ranks apparently never totalled more than 30, disintegrated.

His cover blown, Godfrey folded his tent and crept on to Sacramento where he's now with the fire department. His FBI contact, Steve Christensen, left the agency when Godfrey went public with the SAO story. He's presently a store manager in Kenosh, Utah.

On one point, leftists and SAO defendants agree — the full story hasn't been told.

**ACCORDING** to Frederick Hetter of San Ysidro, who was the attorney for Yakopec and SAO state coordinator Jerry Lynn Davis, the FBI apparently limited its agents' response to carefully screened written questions.

He said the FBI invoked "executive privilege" on the grounds federal agents aren't supposed to testify in state trials.

Hetter, who said his SAO clients may have been unwitting pawns of Godfrey and the FBI, claimed he failed to get hold of FBI documents crucial to Yakopec's defense.

"We just couldn't get our hands on the stuff," he groaned. "And that information was the heart of our defense."

Rex Schroeder, head of the local FBI office, said he felt the FBI had cooperated during the SAO trials, adding, "There's never enough information for defense attorneys."

Schroeder said he hasn't reviewed the Bohmer-Tharp lawsuit yet.

As for Bohmer and ACLU lawyer Rosenbaum, they admit that the FBI's role in the SAO may give the SAO defendants some grounds for filing their own civil rights suit. But generally, they weren't sympathetic towards their ideological adversaries.

Bohmer wryly noted that, on one score, he did end up on the same side of the fence with an SAO member.

For a time, he and Yakopec were cellmates at Chino.

\*\*\*  
Next: The FBI and the SAO — informant Godfrey tells how the relationship worked.



# Conviction Upheld In Shooting

The state Supreme Court has upheld the conviction of George Mitchell Hoover, 37, a key figure in a series of trials here in 1972 involving alleged members of the right-wing paramilitary Secret Army Organization.

The Supreme Court ruling, was announced by the office of Dist. Atty. Edwin L. Miller, follows an Oct. 30, 1973, decision by the Fourth District Court of Appeal reversing the conviction of Hoover. The attorney general's office took the case to the Supreme Court.

Hoover, formerly of Santee, was sentenced to five years to life in state prison in January, 1973, following his conviction in Superior Court on charges of assault with a deadly weapon, firing into an occupied dwelling and possession of a billy club.

Hoover appealed the conviction through Appellate Defenders, Inc., questioning the credibility of a key prosecution witness. The witness was Howard Barry Godfrey, a former San Diego fireman who was a paid FBI informant assigned to infiltrate extremist groups.

Hoover contended the Superior Court jury should have been allowed to weigh whether Godfrey was working as a "double agent" with both the FBI and the Secret Army Organization, finally deciding to testify for the state to protect himself.

The charges against Hoover stemmed from the firing of a bullet into the home of Peter Bohmer, then a former assistant professor at San Diego State University, on Jan. 6, 1972. The bullet struck a friend of Bohmer, Paula Tharp, 23, wounding her in the arm. Bohmer resided on Muir Avenue in Ocean Beach at the time.

(Indicate page, name of newspaper, city and state.)

SAN DIEGO UNION  
12/6/74

Date:  
Edition:  
Author:  
Editor:  
Title:

Character:  
or  
Classification:  
Submitting Office:

Being Investigated

157-3017  
170-286-164

SEARCHED	INDEXED
SERIALIZED	FILED
DEC 6 1974 /	
FBI-SAN DIEGO	

162

1-157-2815 (SAO)  
① 170-286 (Godfrey)  
2-157-3017 (Horn)

1. Send LHM  
2. Return from ADEX

(Mount Clipping in Space Below)

# San Diego County Supervisor Admits 'Pranks' on Leftists

BY NARDA Z. TROUT

Times Staff Writer

SAN DIEGO—The chairman of the San Diego County Board of Supervisors, who had previously denied allegations that he harassed leftists here, has now admitted "some pranks."

In a report made public by a research group here, Supervisor Lou Conde said he disrupted a Peace and Freedom Party open house and also attempted to hang controversial college professor Herbert Marcuse in Effingham.

In both occasions he was accompanied by alleged members of the Minutemen, a now defunct right-wing paramilitary organization that carried on a widespread campaign of violence and harassment against the movement here in the late 1960s.

Last year, in an interview with The Times, Conde denied these activities. They occurred before he was elected to the Board of Supervisors in 1972.

Conde's statements were included in one of 13 profiles on the county's supervisors and eight state legislators which were published Tuesday

by CalPIRG (California Public Interest Research Group), a Ralph Nader-type organization here.

The Conde profile shed some further light on an era of harassment and violence against the left documented by the local underground newspaper, The Door, as well as by local law enforcement officials.

Conde was reportedly active in the late 1960s when the Minutemen and its successor, the Secret Army Organization, targeted leftists for firebombings, shootings and harassing phone calls.

Conde, 47, had previously denied his activities in articles in The Door, but he finally admitted the incidents to CalPIRG researchers Chris Bystrom and Alan Friedman after their exhaustive, two-month long investigation.

He denied being a Minutemen member, although he said he was friends with its then recognized West Coast leader, Troy Houghton, and Houghton's wife, Bettie, and at one time gave Houghton a military

Please Turn to Page 4, Col. 1

100-16205-Sub B-11-2430  
2/25

(Indicate page, name of newspaper, city and state.)

Los Angeles Times  
9/19/74

Date:  
Edition:  
Author:  
Editor:  
Title:

12

Character: LOU Conde  
or  
Classification:  
Submitting Office: 170-286-163  
 Being Investigated

100-140617  
Make copies for:  
1-170-286 (H. H. [unclear])  
1-157-2815 (SAO)  
1-157-1798 (Minutemen)  
1-100- (Herbert Marcuse)  
1-157-1614 (Troy Houghton)  
1-157-1813 (Bettie Houghton)

SEARCHED [initials] INDEXED [initials]  
SERIALIZED [initials] FILED [initials]  
SEP 19 1974  
FBI-SAN DIEGO  
LN



Date prepared

8/8/74

Date received

8/5/74

Received from (name or symbol number)

ISD ~~NP OF AGENT~~ 2157-21

Received by

SA Endon Beteman

Method of delivery (check appropriate blocks)

in person

by telephone

by mail

orally

recording device

written by Informant

Orally furnished and reduced to writing by Agent:

Date

Dictated

to

Date of Report

7/29/74

Transcribed

Authenticated by Informant

Date(s) of activity

8/11/74

Brief description of activity or material

FINANCES - ~~Los Angeles~~ metzger  
Dana Occoaside Calif.

File where original is located if not attached

170-512A

\* INDIVIDUALS DESIGNATED BY AN ASTERISK (\*) ONLY ATTENDED A MEETING AND DID NOT ACTIVELY PARTICIPATE. VIOLENCE OR REVOLUTIONARY ACTIVITIES WERE NOT DISCUSSED.

Information recorded on a card index by \_\_\_\_\_ on date \_\_\_\_\_

Remarks:

FURTHER DISSEMINATION LEFT TO RECEIVING OFFICE

- ( ) 170-512A-308
- ( ) 157-4323 (RECU)
- ( ) 105-6730 (AL FATAH)
- ( ) 105-7470 (JDE)
- ( ) 157-4340 (LIBERTY AMENDMENT)
- ( ) 157-4168 (MCC)
- ( ) 157-28 (NSAPP)
- ( ) 157-4024 (ELLEN ADAMS)
- ( ) 157-4448 (AL ALDINGER)
- ( ) 157-5018 (JOSEPH BEMMENSEN)
- ( ) 157-2527 (HARRIET BRINKER)
- ( ) 157-3484 (JANET BRINKER)
- ( ) 157-3087 (JOSEPH BRINKER)
- ( ) 157-4019 (ROBERT BROWN)
- ( ) 157-4076 (BERT CAMPERAT)
- ( ) 157-2897 (WILLIAM DOMASK)
- ( ) 157-152 (RON EDDY)
- ( ) 157-4449 (JOHN FINN, JR.)
- ( ) 157-3300 (P.T. GAVIN)
- ( ) 157-4269 (KENT GEDDIS)
- ( ) 157-4434 (NELLY JOHNSON)

JAMES K. WARNER  
LIBERTY LOBBY  
RICK WORTON

Det. E. Rogers, Occoaside,  
" Len Oberlin, SDD and  
Deputy Sheriff Juv. Manager advised.

Block Stamp

170-286-162

SEARCHED	INDEXED
SERIALIZED	FILED
AUG 23 1974	
FBI - SAN DIEGO	

2 - Los Angeles (RM)  
EMG: S  
(11)

- ( ) 157-28 (THOMAS FRANKLIN KNIGHT)
- ( ) 157-450 (ROBIN LIPPERT)
- ( ) 157-437 (DENNIS LOSO)
- ( ) 157-4131 (CHARLES MARTIN)
- ( ) 157-2521 (DAVID "BILL" MILLER)
- ( ) (ANN NATTER)
- ( ) 157-4273 (WILLIAM PROBERT)
- ( ) 157-4553 (ROBERT RAYBURN)
- ( ) 157-3498 (WESLEY ROUNDS)
- ( ) 157-4274 (Mr. KARL SACK)
- ( ) 157-4275 (Mrs. KARL SACK)
- ( ) 157-4252 (CARL SCHMIDT)
- ( ) 157-4271 (DONALD SEABURG)
- ( ) 157-4029 (ART SHOOT)
- ( ) 157-4546 (J. ANDREW SIMPSON)
- ( ) 157-201 (GERALD SMITH)
- ( ) 157-4248 (GEORGE UDBARY)
- ( ) 157-4266 (MARY UDBARY)
- ( ) 157-2610 (MICKEY WAKEFIELD)
- ( ) 157-3138 (VICTOR WALTON)
- ( ) 157-2524 (GERALDINE WATSON)
- ( ) 157-2545 (RAY WILSON)
- ( ) 157-2506 (JACK ZIMMERMAN)
- ( ) 157-4447 (BARBARA HUTCHINSON)
- ( ) 157-4545 (CHANNCEY CURR)
- ( ) 157- (Bernard Dower)
- ( ) 157-4023 (ARNOLD DRESSEN)
- ( ) 157-3169 (DONNA LEE HARTLEY)
- ( ) 157-3170 (CALVIN FOX)

- 1- 157-4557 (Tom Metzger)
- 1- 157-2933 (Stanley M. Dale)
- ① 170-286 (Godfrey)

Informant could be identified.  
 Deleted material not given  
 to Godfrey.

ES: Dennis Loso and Tom Metzger; demonstration in Oceanside; James K. Warner; Rick Norton.

Dennis Loso and Tom Metzger

The monthly financial contributions to extreme right-wing causes of Dennis Loso and Tom Metzger have been learned. Loso contributes \$65 per month to Bill Gale's Ministry of Christ Church, \$35 monthly to James K. Warner of the same organization, and \$40 each month to other groups including Liberty Lobby. This totals \$150 per month. As to Metzger, in spite of having a wife and four children to care for, it is known that he gives \$100 of his monthly income to all Far Right causes combined. Loso is going to urge about four or five other similar thinking businessmen in Escondido to start contributing substantially to these causes. Said Loso, "It's time to tell them to put up their money or shut up"..

Demonstration in Oceanside

A Ministry of Christ Church-Christian Crusade type group is planning to hold a demonstration in Oceanside on Sunday, August 11, 1974. No particular issue is involved but Oceanside was chosen for the site of this demonstration due to the racial problems, especially crime rate, which have plagued that city in the past year. The primary banner to be used will be a red flag containing a white circle which encompasses the Christian Cross. Enclosed with this report you will find a small reproduction of this banner. Attempts are being made to have several of these flags made up prior to the demonstration. American flags will also be displayed. The way this White identity group intends to run itself is much more loose than the very inflexible National Socialist White People's Party. The leaders of each area will be free to run the show their own way in order to better accommodate local issues and conditions. Only two ex-Nazis are to be invited to this demonstration. They are Ron Eddy of Poway and Mickey Wakefield of Escondido. This group, led by Dennis Loso and Tom Metzger, plans to hold one demonstration per month somewhere in San Diego County. Members of this group will not attend demonstrations when they are held in the town of the members' residence.

James F. Warner

James F. Warner of the MCC recently returned to the United States from Spain where he was to serve as a keynote speaker at the aborted international anti-Communist convention. Warner plans to print up a

*Sanderson 7-29-74*

stantial number of William Gale's book Racial and National Identity Spanish and smuggle them into Spain for distribution there. He hopes to do a similar job in several South American countries at some later date.

Rick Norton

One man who has particularly impressed Dennis Loso is a man named Rick Norton. Norton resigned his position as West Coast coordinator for Liberty Lobby and has begun working for James K. Warner. According to Loso, Norton is very dedicated to the cause of White identity. One final note on Loso. He said, "I'd like to take the Swastika and just gas all the Jews but the Swastika just won't work; it is a political straight jacket". According to Loso, whenever White identity demonstrations are held, there will be no introductions between people from different areas. Only the leader of each area will know who his own people are but none will know who the affiliates from other towns are. This tactic is designed to minimize FBI infiltration.

That is all for now. Hope this helps.

*Sandman 7-29-74*

P.S.-Stan McDade claims that Barry Godfrey is back in San Diego.

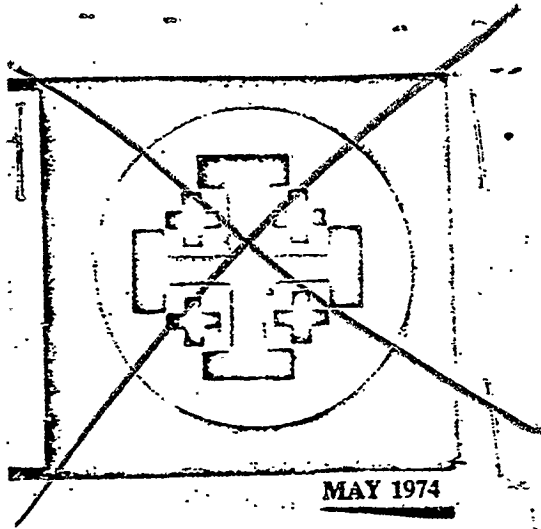

MAY 1974

UNITED STATES GOVERNMENT

# Memorandum

TO : SAC, SAN DIEGO (170-286)

DATE: 7/30/74

FROM : SAC, LOS ANGELES (157-8214) (RUC)

UNCLASSIFIED

SUBJECT: HOWARD BARRY GODFREY  
EM - SAO  
OO: San Diego

Enclosed for San Diego is a copy of a Los Angeles County Jail Booking and Property Record pertaining to arrest of LOUIS JACKSON on 7/9/74; also one copy of a letter dated 7/5/73 addressed to BILL RITTER, Editor, "The Door", Post Office Box 2022, San Diego, California, from JERRY BUSCH. Also enclosed is an FD-306 containing information received from LA 6993-E on 11/28/72 which was not previously furnished to San Diego.

On 7/11/74, Officer TOM GREEP, Los Angeles County Sheriff's Office (LACSO), Intelligence Division, advised that LOUIS JACKSON, a Negro, born 1/13/43, in Texas, had been arrested by the LACSO on a traffic warrant charge but released as not being the person named in the warrant. When JACKSON was picked up, he had a jacket, which he said belonged to one ERIC. In the pocket of the jacket was found a letter, a copy of which is enclosed. Officer GREEP said that JACKSON said he knew nothing about the letter. JACKSON advised that ERIC lived in Playa Del Rey in the Los Angeles area. Officer GREEP said he would provide copies of the booking record and letter.

On 7/16/74, a copy of the booking record and letter were received by the Los Angeles Office from Officer GREEP by mail. They are being enclosed. GREEP also sent a note advising that JACKSON's true name was LOUIS TACKWOOD.

San Diego will note that the letter contains, among other matters, extensive information regarding HOWARD BARRY GODFREY.

- 2 - San Diego (Enc. 3) (RM)
- 1 - Los Angeles (Sq. #6)

ANC/met  
(3)

*Copy of letter  
& info contained herein must  
that re Louis Jackson previously  
received. Jilg*

*See*

170-286-160

SEARCHED	INDEXED
SERIALIZED	FILED
AUG 1 1974	
FBI - SAN DIEGO	

*Belton*



Buy U.S. Savings Bonds Regularly on the Payroll Savings Plan

LA 157-8214

Los Angeles is taking no further action with reference to the contents of the letter. In view of the letter's contents, it is suggested that San Diego review it carefully and take any steps believed necessary.

- 2\* -

LOS ANGELES COUNTY JAIL  
BOOKING AND PROPERTY RECORD

BOOKING NO.	LOC. BKD.	DR. LIC. NO.	STATE	STATION RECORDS	
	EPK	N.I.P.			
ARRESTEE'S NAME (LAST, FIRST, MIDDLE)				LENGTH OF TIME RESIDED AT PRESENT RESIDENCE	
JACKSON, LOUIS (NMAN)					
ADDRESS			CITY	SEX	LENGTH OF TIME RESIDED WITHIN STATE
9416 S. FIGUEROA ST. #1			LA.	M	
DESCENT	HAIR	EYES	HEIGHT	WEIGHT	BIRTHDATE
N	BLK	BRN	509	145	1-13-43
VEH. LIC. NO.	STATE	RPT. DIST.	AKA/NICKNAME		
01W 186	CALIF.	0180	NONE		
BIRTHPLACE		FILE NO.	AD. CHG.	MARITAL STATUS	
TEXAS			N		
AG'Y. OR DETAIL ARRESTING	DATE & TIME ARRESTED	TIME BKD.	NUMBER OF DEPENDENTS		AGES
0101	7-9-74 0230	0235			
LOCATION OF ARREST			TOTAL BAIL	MISDEMEANOR DISPOSITION BY:	
1216 E. 94 PL.					
CHARGE			WARR./COMM. NO.	REASON	

JAIL LOC.	ARRAIGN. DATE	TIME	COURT	PRISONER'S SIGNATURE WHEN BOOKED	
EPK				X [Signature]	
SOC. SEC. NO.	OBSERVABLE PHYSICAL ODDITIES			OCCUPATION	
UNKNOWN	2-3" SCARS ON LEFT FOREARM			MOTEL MANAGER	
EMPLOYER (FIRM OR PERSON'S NAME, CITY, & PHONE NO.)			SPECIAL MEDICAL PROBLEM		
FRANCIS LOUIS MOTEL			NONE		
CLOTHING WORN		LOCATION OR DISPOSITION OF VEHICLE			
WHT. JACKET RED PLUM SLIPKNS		LEFT AT L.O. FOR SUSPECTS REQUEST			
IN CASE OF EMERGENCY NOTIFY (NAME, RELATIONSHIP, ADDRESS, CITY & PHONE NO.)					
KATHERINE JACKSON WIFE SAME UNKNOWN PHONE #					
ARRESTING OFFICER		BOOKING EMPLOYEE		SEARCHING OFFICER	
B. WRIGHT 9921				C. BLACKWELL 0285	
CASH RETAINED	PROPERTY				
4.81	NONE				
				PRISONER'S SIG., FOR REC'T. OF FOREGOING CASH & PROPERTY	
				X [Signature]	
CASH DEPOSITED	PROPERTY				
136.00	MISC. PAPERS, BLU PLASTIC COMP, 2 BLK PLASTIC TIE				
					PRISONER'S SIG. FOR REC'T. OF REMAINING CASH & PROPERTY
					X [Signature]

7686508-SH-J-293 2/73

170-286-159

SEARCHED	INDEXED
SERIALIZED	FILED
AUG 14 1974	
FBI - LOS ANGELES	





2. In November, 1949 I was asked to go on a "soft penetration," for intelligence gathering purposes, with Godfrey. I was asked to make a report on Godfrey's conduct and ability. Godfrey was introduced to me only as "Barry".

We met at a San Diego tavern, the Arrow Club, on El Cajon Blvd. From there we drove to the Lake Elsinore area and visited the home of an elderly gentleman, whose name and supposed importance I have forgotten.

For someone who was supposed to be an "intelligence type", Godfrey impressed me as ill-fitted for the role. He alternately exhibited physical traits or gestures — particularly his eyes and hands — which I would classify as; 1) sly or sneaky, 2) nervousness or cowardice and 3) awareness of personal guilt. All of these, despite the fact we were breaking no laws, doing no harm and in the house at the invitation of its owner.

Following the "interview", we left the

subject's house and I discovered that we were being followed. Reluctantly - and that's the only way I can describe Godfrey's attitude - he followed my instructions to try to shake our surveyors. Normally, I am fairly competent in breaking a surveillance, but this time it didn't work. Even though we doubled back on the car following us and pulled into a service station, the car was behind us again when we entered the freeway Southbound. Godfrey "panicked" then, increasing his speed and driving directly to San Diego and to a Chinese restaurant where we met his superior, Bill Clay.

In retrospect, wherein we all become geniuses, I can conclude that the surveillance team following us that night consisted of Special Agent Petersen or Christiansen and other FBI storm troopers. That Godfrey's reluctance and panic came from his fear of doing anything counter to his instructions from his employers (the FBI).

3. During the period of November, 1969 to Summer of 1971, Howard Godfrey frequently came to Gunsmoke Ranch on weekends

When various forms of script shooting were practiced for recreation. On these visits, which were always brief - lasting less than an hour - he would take Mr. Hoover or Mr. Jerry Lynn Davis aside for quiet conversations. During these visits, he would "act" as if he did not know Bill Clay or myself.

It was during this time that I learned he had been appointed "Director of Intelligence" for the San Diego area section of the Minutemen.

4. In August of 1971, Godfrey came to my apartment and requested I verify addresses and phone numbers for a series of names he had on 3x5 note cards. He then proceeded to try to "recruit" me for "his intelligence network".

5. It was also during June, July or August of 1971 that both Godfrey and Donald Siretti - posing as "Don Simms" - visited Runsmoke Ranch and, although supposedly "not knowing each other", they spoke together, on at least one occasion, in a manner similar to the conversations Godfrey had previously held with Mr.

Hoover and Mr. Davis.

6. Following these "casual conversations" between two spectators at a shooting match, in October, 1921, Godfrey came up with bizarre ideas to "take care of these Red punks" if the Republican Convention was held in San Diego. Also, a number of us received literature on a new group, the SAO. Mr. Fleury and I were given specific instructions not to involve ourselves in any way with the SAO. Mr. Fleury continued to receive SAO literature (unmasked) although I did not.

Some of Godfrey's ideas included:

1. The use of massive dosages of LSD, cyanide or strychnine introduced into the punch at anti-war group meetings.
2. Bombing of UVAW headquarters, the Guild theatre and several porno shops.
3. Bombings of the homes or offices of anti-war leaders.
4. Kidnaping or assassination of anti-war leaders and activists.
5. Fire bombing of vehicles and other property belonging to anti-war activists.

NOTE: Our general attitude toward Godfrey

and his proposals at that time AS;  
"He's a fucking nut!"

7. By November and December of 1971, Godfrey's "ideas" had solidified — along with the decision to hold the Republican Convention in San Diego. His other ideas having been rejected (I have a strong suspicion that some of them were carried out or attempted by Godfrey) he now proposed that someone construct radio controlled, Freeflight model airplanes to carry payloads of HE and white phosphorous, to be flown over Vacation Island and detonated. When Mr. Hoover, Mr. Fleury and I heard of this idea we rejected the possibility out of hand.

Godfrey likewise attempted to involve others in a conspiracy to manufacture a similar aircraft, loaded with TNT or C-4 plastique, to be flown into Air Force 1 as it landed at Lindberg Field at El Toro Marine Air Base at San Clemente. When I heard rumor of this, I expressed the opinion that Godfrey had lost his mind to ever suggest anything as insane as an attempt on the life of the President. I further stated that if I ever received information that he was actually proceeding, I would report it to the Secret Service.

Others, including Mr. Hoover expressed the same attitude. In retrospect, it appears that those comments must have found their way to Godfrey.

During this time I also learned Godfrey was "San Diego leader" of the SAO.

8. In December, 1971, Godfrey attempted to get someone to assassinate Dr. and Ms. Nancy, Ned von Valkenberg, Peter Baumer and other Anti-war leaders. Again he was refused by everyone he contacted.

9. On January 6, 1972, the attack was made on Peter Baumer's home by Godfrey and someone else, whose identity as yet remains unknown.

10. In February, 1972, on two occasions, shots were fired at Mr. Richard Fleury at his home. (He, like Hoover and I, had refused to go along with any of Godfrey's wild ideas.)

My apartment in San Diego was under surveillance by someone and I was fired at on one occasion where I was staying out of sight. Godfrey told Mr. Hoover that, "Baumer's People figure it was you and Busch who took the shots."

out a contract on you L.B. III."

No sooner was this said than Godfrey began to pressure me to return to my apartment. (He had told Mr. Hoover not to tell me about the "contract" or the surveillance, but Mr. Hoover did.) I reflected that outside of Mr. Fleury, who had also been shot at, Mr. Hoover, his employer and my mother, only Godfrey knew where I was staying. I thus concluded it was he and/or members of his (by his claim) forty person "intelligence" network who had fired the shots at Mr. Fleury and ~~myself~~ myself.

Therefore, on March 2, 1972, I left San Diego County and the United States in fear of my life. (One can not, after all, protect oneself from a hidden assassin!) In light of what has transpired since, I have remained out of the area ever since.

Sure hope this will help, Bill.

Best of luck,  
Jimmy Brael

P.S. Bill, just talked today (Friday, 7-6) with Nonda Tavit of L.A. Times. Please send her a copy of this. JB



Date printed

11/28/72

Date received

11/28/72

Received from (name or symbol number)

LA 6993 - E Informant

Received by

J. Sullivan

Method of delivery (check appropriate blocks)

in person  by telephone  by mail  orally  recording device  written by Informant

If orally furnished and reduced to writing by Agent:

Date

Dictated \_\_\_\_\_ to \_\_\_\_\_

Transcribed \_\_\_\_\_

Authenticated by Informant \_\_\_\_\_

Date of Report

11/28/72

Date(s) of activity

11/20/72

Brief description of activity or material

Mtg of Los Angeles Citizens Council

File where original is located if not attached

170-1631A-169

\* INDIVIDUALS DESIGNATED BY AN ASTERISK (\*) ONLY ATTENDED A MEETING AND DID NOT ACTIVELY PARTICIPATE. VIOLENCE OR REVOLUTIONARY ACTIVITIES WERE NOT DISCUSSED.

Information recorded on a card index by \_\_\_\_\_ on date \_\_\_\_\_

Remarks:

CC: 157-7306 (JACK L. DU LONG)

- ~~157-1013 (RODERIC DUFF)~~
- ~~100-74020 (RICK NORTON)~~
- ~~157-1014 (CALVIN FOX)~~
- ~~100-74758 (WILLIAM YAKOPEC)~~
- ~~157-7641 (GLEN WHEELER)~~
- ~~157- (HAL MC GEE)~~
- ~~157- (SECRET ARMY ORGANIZATION)~~
- ~~157- (HOWARD BERRY GODFREY)~~
- ~~157- (LARRY MAZIMES)~~
- ~~157- (HAL MC GEE)~~
- ~~157- (JOE WEBER)~~
- ~~157- (STAN WADE)~~

JWH/DMB  
(14) DMB Read by DMB

TO BE MAINTAINED

170-286-157

SEARCHED \_\_\_\_\_ INDEXED \_\_\_\_\_  
 SERIALIZED OK FILED OK  
 AUG 2 1974  
 FBI - SAN DIEGO  
 Black Stamp

SEARCHED \_\_\_\_\_ INDEXED \_\_\_\_\_  
 SERIALIZED \_\_\_\_\_ FILED \_\_\_\_\_  
 9 1972  
 FBI - LOS ANGELES

20 November 1972

It has been learned that Jack L. Du Long attended a meeting of the Greater Los Angeles Area Citizens Councils held on this date in the Sparton Room of the Olympian Motor Hotel at 1903 West Olympic Blvd. in Los Angeles California. The meeting was set for 8pm and did start within a few minutes of 8pm. A total of 19 or 20 people were on hand for the meeting. Roderic Duff conducted the meeting. He is the GLAACC leader. He announced that this was the first GLAACC meeting in a year and a half. He indicated that GLAACC had interested itself with local issues during this time. He outlined work in monrovia involving the schools and a local election. Duff stated he planned an important meeting in two months, in late January 1973. He did not state why there would be another meeting so soon after this gathering. It would be unusual in view of the fact that this meeting was the first in eighteen months. Duff discussed the "blood program" that was mentioned in their mail out report of last week in which GLAACC members would donate blood to other GLAACC members only when needed and then direct from donor to donor. In brief the plan is to prevent a GLAACC member from receiving blood from a black. It appears the meeting was called only to hear two speakers. First to speak was a man believed to be named Rick Norton.

~~David Duff~~

Informant



Page Three

20. November 1972

he operates a Gulf station in El Cajon. Fox appears to be in his early 40s, about 5:9 and 170lbs. Fox spoke for over an hour regarding his involvement in the Secret Army Organization in the San Diego area. Fox related how Howard Berry Godfrey started to stop by his station early in 1972. Fox charges that Godfrey tried many times to get him to join the SAO but that he never joined the group. Fox admits he kept some of the literature around the station that Godfrey would leave for him. Fox stated that in mid May he and his wife decided to join the Rev McIntyre and his "Victory march in Washington". Fox charges the FBI then raided his station while he was gone and broke into a file cabinet and then planted material in the cabinet. Fox hints that the FBI claims to have feared that he went east to do harm to A. Bremer after the latter shot Gov. G. C. Wallace in Maryland. Fox then related how he appeared as a witness for William Yakopec in September 1972 and how this has led to his trial on Tuesday 5 December 1972 for perjury. Fox asked all who could to be on hand in December for his trial. Roderic Duff stated he and several other GLAACC members would be present for the trial. Fox stated his legal costs were very high and a collection was taken for him. It was noted that Jack Du Long gave fox \$5.00 and it appeared about \$30 to \$40 may have been given to Fox this evening by the GLAACC members. The meeting ended shortly before 10pm. Among the twenty people present and known to this observer were: Roderic Duff, Jack Du Long,

*Walter P. McIntyre*

Page Four

20 November 1972

Larry Nazimek, Hale McGee, Joe Weber, Stan Wade,  
Glen Wheeler. Others present appear to be long  
term GLAACC members.

*Handwritten signature in a box*

HELP - HELP - HELP

PIORKOWSKI APPRECIATES YOUR PAST ASSISTANCE-BUT NEEDS MORE

① BRING YOUR FRIENDS TO A RALLY FOR PIORKOWSKI.

SUNDAY NOV. 26-----2Pm  
671 W. Arrow  
Claremont, Calif.

NOT GERMAN TO GODFREY

② ATTEND THE TRIAL.

MONDAY---DEC. 4-----9AM  
LA County Courthouse  
300 W. Mission  
Pomona, Calif.

Don't let black extremists pack the courtroom the way they did during the coroner's hearing.

NOTE: To add injury to insult, Piorkowski's enemies are now apparently attempting to sue him for \$5 million.

DO YOU CARE?

WILL YOU BE THERE? AT BOTH

EVENTS? RAND. 114.6.96-1985

UNITED STATES GOVERNMENT

# Memorandum

TO : SAC (170-286)

DATE: 5/16/74

FROM : SA EARL M. PETERSEN

SUBJECT: HOWARD BARRY GODFREY  
INFORMATION CONCERNING

HOWARD BARRY GODFREY has applied for a position as Arson Investigator for the State of California. He scored the top grade in his test and is now being investigated by the California Bureau of Investigation for this position. He is presently working for the State of California in a similar position. SA FRANK M. THOMPSON, CBI is conducting the investigation:

The following information which has all been made public was given to SA THOMPSON upon authority of the SAC:

*Opened 2/4/67*  
HOWARD BARRY GODFREY, Born July 1, 1943, at Portsmouth, England, was an informant of the FBI from August 10, 1967 to November 14, 1972. He reported to the San Diego office. This service was entirely voluntary on his part. During this period of time he furnished a volume of highly reliable information about right wing type groups such as the Minutemen and the Secret Army Organization. He was reimbursed for his service in amounts ranging ~~from~~ up to \$250.00 per month.

On June 22, 1972, GODFREY furnished information indicating that one WILLIAM FRANCIS YAKOPEC intended to bomb "Genies Massage Parlor" in El Cajon. Due to the possibility of loss of life if this bombing was carried out, it was decided to make GODFREY available to testify in the trial of YAKOPEC who had placed a bomb in the Guild Theatre in San Diego on June 19, 1972. As a result of information furnished by GODFREY, a number of persons were tried and convicted and large quantities of firearms, explosives and ammunition were recovered.

The names of individuals arrested tried and convicted was given to SA THOMPSON.

EMP:emp  
(2)

170-286-156  
SEARCHED  
SERIALIZED  
INDEXED  
FILED  
MAY 16 1974  
FBI - SAN DIEGO  
*Earl M. Petersen*



Buy U.S. Savings Bonds Regularly on the Payroll Savings Plan

4/5/74

SD 748-PE-1 INFORMANTS Earl M. Peterson

Method of delivery (check appropriate blocks)

in person  by telephone  by mail  orally  recording device  written by Inf.

If orally furnished and reduced to writing by Agent:

Date of Report

Dictated 4/6/74 to Sue Fox

4/5/74

Transcribed 4/8/74

Date(s) of activity

3/28/74

Authenticated by Informant \_\_\_\_\_

Brief description of activity or material

MCC meeting 3/28/74 - S.D.

File where original is located if not attached

170-544A

\* INDIVIDUALS DESIGNATED BY AN ASTERISK (\*) ONLY ATTENDED A MEETING AND DID NOT ACTIVELY PARTICIPATE. VIOLENCE OR REVOLUTIONARY ACTIVITIES WERE NOT DISCUSSED.

Information recorded on a card index by \_\_\_\_\_ on date \_\_\_\_\_

Remarks:

- (X) 170-544A - 10
- ( ) 157-4323 (AFCJ)
- ( ) 105-6730 (AL FATAH)
- ( ) 105-7470 (JDL)
- ( ) 157-4340 (LIBERTY AMENDMENT)
- (/ ) 157-4168 (MCC)
- ( ) 157-2847 (NSWPP)
- (/ ) 157-4024 (ELLEN ADAMS)
- ( ) 157-4448 (AL ALDINGER)
- ( ) 157-3018 (JOSEPH BENINTENDE)
- ( ) 157-2527 (HARRIET BRINKER)
- (/ ) 157-3484 (JANET BRINKER)
- (/ ) 157-4087 (JOSEPH BRINKER)
- ( ) 157-4019 (ROBERT BROWN)
- ( ) 157-4076 (BERT CAMPERAT)
- ( ) 157-2897 (WILLIAM DOMASK)
- ( ) 157-152 (RON EDDY)
- ( ) 157-4449 (JOHN FINN, JR.)
- ( ) 157-3300 (P.T. GAVIN)
- ( ) 157-4269 (KENT GEDDIS)
- ( ) 157-4434 (NELLY JOHNSON)

INDEX TO 157-4168  
 Christian Defense League (C.D.L.)  
 CALIFORNIA RANGERS  
 Colonel WILLIAM GALE  
 (BACKGROUND)  
 FAX EXPO 4/5-6/74  
 Further dissemination left  
 to receiving office.

- ① 170-286 (copy)
- 2- LOS ANGELES (157-7775) (RM)

EMP: cf  
(19)

Block Stamp

170-286-155

SEARCHED	INDEXED
SERIALIZED	FILED
APR 1 1974	
FBI - SAN DIEGO	



- ( ) 157-4407 (D. CHARLES WELT KENDALL)
- ( ) 157-2898 (THOMAS FRANKLIN KNIGHT)
- ( ) 157-4450 (ROBIN LIPPERT)
- ( ) 157-3487 (DENNIS LOSO)
- ( ) 157-4131 (CHARLES MARTIN)
- ( ) 157-2521 (DAVID "BILL" MILLER)
- ( ) 157-4443 (ANN NETTER)
- ( ) 157-4273 (WILLIAM PROBERT)
- ( ) 157-4553 (ROBERT RAYBURN)
- ( ) 157-3498 (WESLEY ROUNDS)
- ( ) 157-4274 (Mr. KARL SACK)
- ( ) 157-4275 (Mrs. KARL SACK)
- ( ) 157-4252 (CARL SCHMIDT)
- ( ) 157-4271 (DONALD SEABURG)
- ( ) 157-4029 (ART SHOOT)
- ( ) 157-4546 (J. ANDREW SIMPSON)
- ( ) 157-201 (GERALD SMITH)
- ( ) 157-4248 (GEORGE UDBARY)
- ( ) 157-4266 (MARY UDBARY)
- ( ) 157-2610 (MICKY WAKEFIELD)
- ( ) 157-3138 (VICTOR WALTON)
- ( ) 157-2524 (GERALDINE WATSON)
- ( ) 157-2545 (RAY WILSON)
- ( ) 157-2506 (JACK ZIMMERMAN)
- ( ) 157-4447 (BARBARA HUTCHINSON)
- ( ) 157-4545 (CHANCEY CURR)
- ( ) 157- (Bernard Dower)
- ( ) 157-4023 (ARNOLD DRESSEN)
- ( ) 157-3169 (DONNA LEE HARTLEY)
- ( ) 157-3170 (CALVIN FOX)
- 1 157-4446 (JONATHAN WEST)
- 1 157-3001 (Jenny Lynn Davis)
- 1 157-2815 (SAO)

NOT  
GERMANS  
GODFREY

10

INFORMANT

Report by DON CLARK

4/5/74

Meeting of Colonel WILLIAM GALE at  
O'Neira Hall on the Evening of  
March 28, 1974, San Diego, California

Approximately 75 persons were present at that meeting. It included, among others, GEORGE UDVARY, VICTOR B. WALTON, MICKEY WAKEFIELD, J. ANDREW SIMPSON, ELLEN ADAMS, BILL MILLER, JONATHAN WEST, JOE BRINKER, HARRIET BRINKER, JANET BRINKER, Colonel WILLIAM GALE, ANN NUTTER, and others who are very old and very inactive. There were a number of individuals present who are as yet unknown to me.

GEORGE UDVARY does not seem to have made his move yet--permanent move out of the area. He's still in process, I believe, as best I can tell at this time. MICKEY WAKEFIELD came down from Escondido, was hoping to run into some of his para-military friends, one or two of whom did not evidently arrive. He did run into VICTOR WALTON who he is close to. BILL MILLER was there and very involved on the surface at least. ELLEN ADAMS was distributing literature. JOE and HARRIET BRINKER came in from Escondido and of course are primarily responsible for putting on that monthly meeting and so they were working with that.

There was security that night--more so than would ordinarily be expected. A fellow by the name of DENNIS was inside with a 23-channel, five-watt Citizens Band walkie-talkie, Realistic brand, sold by Radio Shack. He kept monitoring another individual whose name I do not have who was outside. He had a two or three channel Citizens Band walkie-talkie, Midland brand, and they were checking to see if anyone would give them any trouble. This was because of a publication that indicated where their meeting would be held. They didn't indicate what they would do if such trouble arrived.

Colonel GALE discussed an article on himself and the identity movement as written up in Volume V, Issue 14, of a bi-monthly publication, called the San Diego Door. I believe that's a March, 1974 issue. Colonel GALE read directly from the article and made comments and corrections as he went.

He said, now I will read--follow this and read as much as possible that seems relevant. He read from the article: "But the public meetings are only part of the package. Whenever GALE speaks, he recruits followers into the para-military part of his organization. That part is called 'Identity' and has so far incorporated many old Minutemen and secret army elements in Southern California."

To that, Colonel GALE indicated that "Identity" was the name of his church publication--he thought it was

very humorous that they thought it was something else.  
The term is used to describe their philosophy.

*NOT GERMANY TO*  
*BOB FRY*  
The para-military part of their operation is under such titles as the "Christian Posse Association."

I will make another quote here from the publication:

"JERRY LYNN DAVIS, the ex-head of the SAO in California, has been reported at GALE's public meetings." According

to MICKEY WAKEFIELD *IDENTIFIED INFORMANT* who was sitting next to me during this

meeting DAVIS had not, as far as he knew, ever been to a San Diego meeting.

Another quote Colonel GALE made: "Identity is organized in similar fashion to other underground organizations--small cells communicate through a series of intermediaries and blind post office boxes." Colonel GALE did not comment further; however, the mailing network for the national tape groups, the Christian Posse Association groups, and the amateur radio network are the primary communication links of GALE's group.

*NOT GERMANY TO*  
*BOB FRY*  
Another quote Colonel GALE made from the article: "In San Diego, GALE can be heard speaking to his congregation on the fourth Thursday of every month at the O'Neira Club on Holly Street" or something of that nature "between 34th and 35th Streets, one block south of Adams Avenue." The street was incorrectly quoted--it's Hawley, and Colonel GALE made an observation on that, indicating he thought the information was transferred to the person at this publication

by telephone and that he figured, he had that all figured out that way because the person must have misunderstood the name and got it wrong.

The next quote from the publication: "According to one law enforcement source, Identity has about 50 members in the San Diego area, including members of the San Diego Sheriff's Department and reserve police officers." Colonel GALE indicated support from and for law enforcement--indicated he has an assistant pastor in Glendale who has an important position in the Los Angeles County Sheriff's Office, and that he claims support from a number of law enforcement areas.

Another quote he indicated: "As for GALE, he pretends to be a minister of his church and operates through it as his front. GALE was one of the driving forces behind the militant Christian Defense League (CDL) in the 60's. He had formed the small California Rangers in the late 50's. The California State Attorney General's Office described the Rangers as," then they put a quote in here, in this article, "'A secret underground guerrilla force, linked with other non-military organizations by a common ideology and leadership.'" "

Colonel GALE indicated at this meeting the Rangers were registered with the state and had support of California law enforcement.

Another quote from the article that the Colonel

made. "GALE's strategy to recruit members through veterans organizations was thwarted in 1963 when the Long Beach Press Telegram exposed his efforts to convert the American Legion Post in Signal Hill into a Ranger front. It was after this that one of the Rangers was arrested for selling a machine gun and a stem gun to undercover agents." Colonel GALE indicated that he was involved to some extent with this particular post, with this particular veterans group, that he transferred from the Hollywood post. Also, he said that the Ranger's, that particular Ranger's arrest, was an entrapment and an unfortunate error on that Ranger's part.

Another quote he made: "The CDL was quite an organization when GALE was a part of it. It grew to include the Klan, the National States' Rights Party, and many other Right Wing groups." Colonel GALE admitted connection with the Christian Defense League, indicating that he was very active.

Another quote: GALE has ample experience to found a para-military organization. In addition to more than 20 years involvement in right wing circles, GALE is a retired Lieutenant Colonel, U. S. Army. He served with the MAC ARTHUR command after World War II in the counter-insurgency staff," and it goes on. But Colonel GALE corrected this counter-insurgency information. He indicated that he was on the staff of MAC ARTHUR in Japan, but previous to

that was when he was involved in counter-insurgency and that was with the guerrilla activities in the Philippines, which was also indicated in this article.

Then, another interesting thing, he quoted: "The SAO was in large part organized by HOWARD B. GODFREY, an FBI Agent." He didn't have anything notable to say about GODFREY.

*NOT GODFREY*

Actually, one of the things he indicated, too, in this discussion of his was that there is a lot of difficulty getting different right wing groups to cooperate in a military fashion and that that is very necessary and I get the impression that he is attempting and wishes to whip these groups into line in a really efficient military manner that will be very effective and efficient. That is the primary problem. He also indicated his willingness to cooperate with law enforcement, of course on his terms no doubt; and he said he was ready and they were ready to face those Jews and their articles and their so-called exposes and whatever else they might happen to want to do; that they are ready to communicate with their people and take care of anyone who gives them any trouble. He indicated that he had communication links all over--that from his car he could talk immediately with his link in Saugus--I don't know what link he was referring to, but it was in Saugus, and in Glendale and other areas like that, which he mentioned.

That covers much of his comments at that particular meeting. There was quite a lot of response--the people enjoyed that immensely. It was a reaction similar to a grandstanding and I think he was milking it for all he could get.

J. ANDREW SIMPSON resides at 229 Kalmia Street, San Diego, California 92101, telephone number in San Diego 232-5658.

There were some questions and answers during this session. JOE BRINKER was passing out blank pieces of paper so that people could write their comments and questions on the papers which were then passed up to Colonel GALE. Along with those blank pieces of paper, JOE BRINKER had a throw-away on the tax revolt. The heading was "Sunny San Diego Invites You to 1974's Biggest Tax Expo" and then another heading, "Tax Foes Tell Why and How They Stopped Paying Income Tax," etc., etc. It talked about meetings in the San Diego area on that. Registration forms for special get-togethers, in this case, Sheraton Inn-Airport on Friday, April 5th and Saturday, April 6th, 7 P.M. to 11 P.M. on Friday, April 5th; 9 A.M. to 5 P.M. Saturday, April 6th. For those who wish to write for information, they'd write to (for registration or information) to Tax Expo, 1570 Lily Avenue, El Cajon, California 92021. Now whether this point was being stressed more by JOE BRINKER or whether it was also under the tacit approval of Colonel GALE, I do not know.



Among the other literature and material which was picked up at that meeting, I acquired an application for the Identity seminars, "Second and Third National Identity Seminars, Manasseh Ranch, California, Ministry of Christ Church. Second Seminar dates are Saturday, the 26th of April through Tuesday, the 30th of April, 1974. Third Seminar dates are Saturday, the 29th of June through Tuesday the 2nd of July, 1974. Attendance by accepted application only--not open to the public." (They make that a stressed point in this.) "Manasseh Ranch is the national headquarters for the Identity Movement of the Ministry of Christ Church. It is located in the gold Mother Lode area of California. Altitude is nearly 3,000 feet in the high Sierra Nevada Mountains. No sleeping facilities are available so those attending should bring a motor home, camp trailer, camper truck, or travel trailer. If you do not own one, they can be rented for a nominal fee. Since bath and toilet facilities are limited, self-contained recreational vehicles are preferable. You must also bring your own food supply, except that we will have a small commissary to supplement your needs--eggs, bread, butter, potatoes, canned foods, etc. Children will be the responsibility of the parents, although it is possible to arrange for a child care period among those who attend. This can be organized after your arrival. Directions to Manasseh Ranch will be mailed to

you upon receipt of and acceptance of your application to attend. (Please cut off at perforated line and mail application to P. O. Box 423, Glendale, California 91209. Please give the information requested on the application form.)"

Underneath the application: "We wish to attend the Identity Seminar at Manasseh Ranch as indicated. Please place checkmark in the appropriate seminar space." Second Seminar or Third Seminar indicated for placement of the mark.

Following they say, "Religious services begin on Saturday, so arrivals should be prior to those dates." They ask the number of adults, number of children, ages of children, type of recreation vehicle (tent camper, truck camper, motor home, travel trailer), then they indicate here, "We hereby relieve the Ministry of Christ Church from all liability and responsibility to ourselves and all members of our family in event of accident or injury while we are on the church property at Manasseh Ranch, California. . . Name (signed), Address (printed)". . . so on. This is the form for the seminars.

NOT GERMAINE  
GODFREY

MINISTRY OF CHRIST CHURCH

SECOND SEMINAR - Dates are SATURDAY, 26 April thru TUES. 30 April 1974

THIRD SEMINAR - Dates are SATURDAY 29 June thru TUES. 2 July 1974

ATTENDANCE BY ACCEPTED APPLICATION ONLY - NOT OPEN TO THE PUBLIC !

MANASSEH RANCH is the NATIONAL HEADQUARTERS for the IDENTITY movement of the MINISTRY OF CHRIST CHURCH. It is located in the gold mother-love area of California. Altitude is near 3,000 feet in the High Sierra Nevada mountains.

No sleeping facilities are available, so those attending should bring a motor home, camp trailer, camper truck or travel trailer. If you do not own one, they can be rented for a nominal fee. Since bath and toilet facilities are limited, self-contained recreational vehicles are preferable. You must also bring your own food supply except that we will have a small commissary to supplement your needs (eggs, bread, butter, potatoes, canned foods, etc.).

Children will be the responsibility of the parents although it is possible to arrange for child care periods amongst those who attend. This can be organized after your arrival. Directions to Manasseh Ranch will be mailed to you upon receipt of and acceptance of your Application to attend.

(Please cut off at perforated line and mail application to P.O. Box 423, Glendale, California 91205). Please give the information requested on the application form)

APPLICATION

We wish to attend the IDENTITY SEMINAR at Manasseh Ranch as indicated. (Please place check mark in the appropriate Seminar space)

( ) Second Seminar - Sat. 26 April thru Tues. 30 April 1974

( ) Third Seminar - Sat. 29 June thru Tues. 2 July 1974

Religious Services begin on Saturdays, so arrivals should be PRIOR to those dates.

Number of adults \_\_\_\_\_  
Number of children \_\_\_\_\_  
Ages of children \_\_\_\_\_

Type of Recreational Vehicle:  
Tent camper \_\_\_\_\_ Motor Home \_\_\_\_\_  
Truck camper \_\_\_\_\_ Travel Trailer \_\_\_\_\_

We hereby relieve the Ministry of Christ Church from all liability and responsibility to ourselves and all members of our family in the event of accident or injury while we are on the Church property at Manasseh Ranch, California.

NAME (signed) \_\_\_\_\_

Date received: 4/5/74  
 Received from: SD 257-91/N for MONT  
 Received by: SA Carl M. Britner

Method of delivery (check appropriate blocks)  
 in person     by telephone     by mail     orally     recording device     written by Informant

If orally furnished and reduced to writing by Agent:  
 Date: \_\_\_\_\_  
 Dictated \_\_\_\_\_ to \_\_\_\_\_  
 Transcribed \_\_\_\_\_  
 Authenticated by Informant: 3/31/74

Date of Report: 3/31/74

Date(s) of activity: 3/30/74

Brief description of activity or material:  
 No one from NSWSP went to LA to see triumph of the will.

File where original is located if not attached:  
 170-512A

\* INDIVIDUALS DESIGNATED BY AN ASTERISK (\*) ONLY ATTENDED A MEETING AND DID NOT ACTIVELY PARTICIPATE. VIOLENCE OR REVOLUTIONARY ACTIVITIES WERE NOT DISCUSSED.  
 Information recorded on a card index by \_\_\_\_\_ on date \_\_\_\_\_

Remarks:

- (/ ) 170-512A - 238
- ( ) 157-4323 (AFCJ)
- ( ) 105-6730 (AL FATAH)
- ( ) 105-7470 (JDL)
- ( ) 157-4340 (LIBERTY AMENDMENT)
- ( ) 157-4168 (MCC)
- (/ ) 157-28 (NSWPP)
- ( ) 157-4024 (ELLEN ADAMS)
- ( ) 157-4448 (AL ALDINGER)
- ( ) 157-3018 (JOSEPH BENINTENDE)
- ( ) 157-2527 (HARRIET BRINKER)
- ( ) 157-3484 (JANET BRINKER)
- ( ) 157-3087 (JOSEPH BRINKER)
- ( ) 157-4019 (ROBERT BROWN)
- ( ) 157-4076 (BERT CAMPERAT)
- ( ) 157-2897 (WILLIAM DOMASK)
- (/ ) 157-152 (RON EDDY)
- ( ) 157-4449 (JOHN FINN, JR.)
- ( ) 157-3300 (P.T. GAVIN)
- ( ) 157-4269 (KENT GEDDIS)
- ( ) 157-4434 (NELLY JOHNSON)

NOT CONTAINING TO GODFREY

EMB:ig  
 (10)

Block Stamp

170-286-154

SEARCHED	INDEXED
SERIALIZED	FILED
APR 5 1974	
FBI - SAN DIEGO	

- ( ) 157-447 (Dr. CHARLES WELT KENDAL)
- (X) 157-289 (THOMAS FRANKLIN KNIGHT)
- ( ) 157-441 (ROBIN LIPPERT)
- ( ) 157-3487 (DENNIS LOSO)
- ( ) 157-4131 (CHARLES MARTIN)
- ( ) 157-2521 (DAVID "BILL" MILLER)
- ( ) (ANN NATTER)
- ( ) 157-4273 (WILLIAM PROBERT)
- ( ) 157-4553 (ROBERT RAYBURN)
- ( ) 157-3498 (WESLEY ROUNDS)
- ( ) 157-4274 (Mr. KARL SACK)
- ( ) 157-4275 (Mrs. KARL SACK)
- ( ) 157-4252 (CARL SCHMIDT)
- ( ) 157-4271 (DONALD SEABURG)
- ( ) 157-4029 (ART SHOOT)
- ( ) 157-4546 (J. ANDREW SIMPSON)
- ( ) 157-201 (GERALD SMITH)
- ( ) 157-4248 (GEORGE UDBARY)
- ( ) 157-4266 (MARY UDBARY)
- ( ) 157-2610 (MICKEY WAKEFIELD)
- ( ) 157-3138 (VICTOR WALTON)
- ( ) 157-2524 (GERALDINE WATSON)
- ( ) 157-2545 (RAY WILSON)
- ( ) 157-2506 (JACK ZIMMERMAN)
- ( ) 157-4447 (BARBARA HUTCHINSON)
- ( ) 157-4545 (CHAUNCEY CURR)
- ( ) 157- (Bernard Dower)
- ( ) 157-4023 (ARNOLD DRESSEN)
- ( ) 157-3169 (DONNA LEE HARTLEY)
- ( ) 157-3170 (CALVIN FOX)

NOT GERMAN  
TO GODFREY

① 170-286 (Godfrey)

March 11, 1974

Showing of Triumph of the Will.

It has been learned that the showing of the motion picture Triumph of the Will by the Los Angeles unit of the National Socialist White People's Party on Saturday night, March 30, 1974 received no response whatever from the San Diego unit of the NSWPP. Originally Tom Knight, Charles Martin, Jack Zimmerman and Mickey Wakefield had all planned to drive up to Los Angeles together to view the film. However, Zimmerman learned that his son was flying down from San Francisco to visit him and so he cancelled out. Martin does not own a car and since neither Knight or Wakefield had reliable transportation on this particular weekend, the entire plan was dropped.

Ron Eddy just received a letter from Ray Wilson. In this letter, Wilson thanked Eddy for his support during the period when he (Wilson) ran the San Diego unit of the NSWPP.

Vic Walton claims to have "put out the word" on Barry Godfrey "a good year" before the arrests of members of the Secret Army Organization in San Diego. Walton says he warned the SAO people to look out for Godfrey because he believed Godfrey to be half Jewish and, therefore, untrustworthy. Walton says Godfrey was too pre-occupied with firearms and explosives to be trusted. He admitted, however, that this seemed to appeal to the SAO affiliates.

That is all for now.

Barry Godfrey

Date prepared

3/26/74

Date received

3/25/74

Received from (name or symbol number)

SD 2157-E (IN FOOTPRINT) SA Paul M. Belter

Received by

Method of delivery (check appropriate blocks)

in person  by telephone  by mail  orally  recording device  written by Informant

If orally furnished and reduced to writing by Agent:

Date

Dictated \_\_\_\_\_ to \_\_\_\_\_

Transcribed \_\_\_\_\_

Authenticated by Informant 3/25/74

Date of Report

3/25/74

Date(s) of activity

3/24/74

Brief description of activity or material

Target shooting Smith w/ rifle to Wilson

File where original is located if not attached

170-512A

\* INDIVIDUALS DESIGNATED BY AN ASTERISK (\*) ONLY ATTENDED A MEETING AND DID NOT ACTIVELY PARTICIPATE. VIOLENCE OR REVOLUTIONARY ACTIVITIES WERE NOT DISCUSSED.

Information recorded on a card index by \_\_\_\_\_ on date \_\_\_\_\_

Remarks:

- ( ) 170-512A - 235
- ( ) 157-4323 (AFCJ)
- ( ) 105-6730 (AL FATAH)
- ( ) 105-7470 (JDL)
- ( ) 157-4340 (LIBERTY AMENDMENT)
- ( ) 157-4168 (MCC)
- ( ) 157-28 (NSWPP)
- ( ) 157-4024 (ELLEN ADAMS)
- ( ) 157-4448 (AL ALDINGER)
- ( ) 157-3018 (JOSEPH BENINTENDE)
- ( ) 157-2527 (HARRIET BRINKER)
- ( ) 157-3484 (JANET BRINKER)
- ( ) 157-3087 (JOSEPH BRINKER)
- ( ) 157-4019 (ROBERT BROWN)
- ( ) 157-4076 (BERT CAMPERAT)
- ( ) 157-2897 (WILLIAM DOMASK)
- ( ) 157-152 (RON EDDY)
- ( ) 157-4449 (JOHN FINN, JR.)
- ( ) 157-3300 (P.T. GAVIN)
- ( ) 157-4269 (KENT GEDDIS)
- ( ) 157-4434 (NELLY JOHNSON)

NOT GERMANE TO RODNEY

GMB:8  
8

Block Stamp

170-286-153  
[Stamp with handwritten signatures]

- ( ) 157-4407 (Dr. CHARLES WELT KENDALL)
- ( ) 157-2898 (THOMAS FRANKLIN KNIGHT)
- ( ) 157-4450 (ROBIN LIPPERT)
- ( ) 157-3487 (DENNIS LOSO)
- ( ) 157-4131 (CHARLES MARTIN)
- ( ) 157-2521 (DAVID "BILL" MILLER)
- ( ) (ANN NATTER)
- ( ) 157-4273 (WILLIAM PROBERT)
- ( ) (ROBERT RAYBURN)
- ( ) 157-3498 (WESLEY BOUNDS)
- ( ) 157-4274 (Mr. KARL SACK)
- ( ) 157-4275 (Mrs. KARL SACK)
- ( ) 157-4252 (CARL SCHMIDT)
- ( ) 157-4271 (DONALD SEABURG)
- ( ) 157-4029 (ART SHOOT).
- ( ) (J. ANDREW SIMPSON)
- ( ) 157-201 (GERALD SMITH)
- ( ) 157-4248 (GEORGE UDBARY)
- ( ) 157-4266 (MARY UDBARY)
- ( ) 157-2610 (MICKEY WAKEFIELD)
- ( ) 157-3138 (VICTOR WALTON)
- ( ) 157-2524 (GERALDINE WATSON)
- ( ) 157-2545 (RAY WILSON)
- ( ) 157-2506 (JACK ZIMMERMAN)

NOT GERMAN,  
TO GODFREY

1- 157-3017 (George Hoover)

① 170-286 (Godfrey)



by Sandman

INFORMANT

Mar 25, 1974

ACTS: Activities attitudes of Gerald Smith, Mickey Wakefield and Ray Wilson; attitude of Vic Walton.

On Sunday, March 24, 1974 Gerald Smith and Ray Wilson visited the home of Mickey Wakefield in Escondido. Both men brought their families along and then all eight people proceeded to the Keyes Creek area north of Valley Center for some target shooting. Gerald Smith's wife, Jeanette is 36 years of age but had never yet fired a gun of any kind in her life. Wakefield loaned her one of his guns and let her give it a try. She did fairly well for a beginner, hitting a bottle with a .22 automatic pistol at a range of 40 feet on her third try.

Wilson and Wakefield discussed Ben Klassen's book Nature's Eternal Religion. Wilson feels that the author is wrong to use a religious approach to try to provide an answer to what is essentially a political and racial problem. Wakefield thinks the book's greatest weakness is the fact that it so vehemently attacks Christianity. He believes that most rightists who have any religious sense of being at all would reject this as quickly as most Americans already reject the Swastika. Smith has not yet become acquainted with the book and so had no opinion to offer.

Vic Walton's Attitude

Vic Walton recently expressed his opinion of George Mitchell Hoover. He said of Hoover, "He is not the kind of man I would ever want to have for an enemy because I don't think he would hesitate to do you in". Walton continued, "However, Hoover seems like a real nice guy". "He is very quiet and doesn't have much to say".

Walton is very anxious to have Ron Eddy of Poway read Nature's Eternal Religion. Walton is really making a determined effort to push this book. Its author, Ben Klassen, seems to think Hitler was the best thing that ever happened to the world and concludes his book by saying that ultimately the White race will have to occupy all the usable land on Earth. That kind of tells you something without really saying it. Walton says that Barry Godfrey once told him that his (Walton's) telephone was bugged.

That's it for now.

Sandman 3-25-74

INFORMANT

Date received 3/25/74 Received from SD 2157-E [unclear] SA and in return Received [unclear]

Method of delivery (check appropriate blocks)  
 in person  by telephone  by mail  orally  recording device  written by Informant

If orally furnished and reduced to writing by Agent:  
 Date \_\_\_\_\_  
 Dictated \_\_\_\_\_ to \_\_\_\_\_  
 Transcribed \_\_\_\_\_  
 Authenticated by Informant 3/24/74

Date of Report 3/24/74

Date(s) of activity  
3/23/74  
3/28/74  
4/11/74

Brief description of activity or material  
USWB meeting 3/23/74  
New Political Unit to be formed by V. Walter  
Jerome Practice - Washfield, Smith & Wilson

File where original is located if not attached  
170-572A

\* INDIVIDUALS DESIGNATED BY AN ASTERISK (\*) ONLY ATTENDED A MEETING AND DID NOT ACTIVELY PARTICIPATE. VIOLENCE OR REVOLUTIONARY ACTIVITIES WERE NOT DISCUSSED.  
 Information recorded on a card index by \_\_\_\_\_ on date \_\_\_\_\_

- Remarks:
- (1) 170-512A - 234
  - ( ) 157-4323 (AFCJ)
  - ( ) 105-6130 (AL FATAH)
  - ( ) 105-7170 (JDL)
  - ( ) 157-4340 (LIBERTY AMENDMENT)
  - (1) 157-4168 (MCC)
  - (1) 157-28 (NSAPP)
  - ( ) 157-4024 (ELLEN ADAMS)
  - ( ) 157-4448 (AL ALDINGER)
  - ( ) 157-3018 (JOSEPH BENINTENDE)
  - ( ) 157-2527 (HARRIET BRINKER)
  - ( ) 157-3484 (JANET BRINKER)
  - ( ) 157-3087 (JOSEPH BRINKER)
  - ( ) 157-4019 (ROBERT BROWN)
  - ( ) 157-4076 (BERT CAMPERAT)
  - ( ) 157-2897 (WILLIAM DOMASK)
  - ( ) 157-152 (RON EDDY)
  - ( ) 157-4449 (JOHN FINN, JR.)
  - ( ) 157-3300 (P.T. GAVIN)
  - ( ) 157-4269 (KENT GEDDIS)
  - ( ) 157-4434 (NELLY JOHNSON)
  - 1- 157- (Rich Stanley)
  - 2- Los Angeles (157-9) (RM)
  - 1- 157-2933 (STANLEY Mc DARE)
  - ① 170-286 (Barry Grafey)

**GERMANE**  
 further dissemination left to remaining offices  
 INDEX TO 157-3138:  
 NATURES ETERNAL RELIGION by BEN KLASSEN (a book) 157-2770\*  
 Church of the Creator  
 WILLIAM DREXEL

Block Stamp  
170-286-152  
 SEARCHED [initials]  
 SERIALIZED [initials]  
 MAR 25 1974  
 FBI - SAN DIEGO  
12

EMPIRE  
 (14)

- ( ) 157-4407 (Dr. CHARLES WELT KENDALL)
- ( ) 157-2898 (THOMAS FRANKLIN KNIGHT)
- ( ) 157-4450 (ROBIN LIPPERT)
- ( ) 157-3487 (DENNIS LOSO)
- ( / ) 157-4131 (CHARLES MARTIN)
- ( ) 157-2521 (DAVID "BILL" MILLER)
- ( ) (ANN NATTER)
- ( ) 157-4273 (WILLIAM PROBERT)
- ( ) 157-4553 (ROBERT RAYBURN)
- ( ) 157-3498 (WESLEY ROUNDS)
- ( ) 157-4274 (Mr. KARL SACK)
- ( ) 157-4275 (Mrs. KARL SACK)
- ( ) 157-4252 (CARL SCHMIDT)
- ( ) 157-4271 (DONALD SEABURG)
- ( ) 157-4029 (ART SHOOT)
- ( ) 157-4546 (J. ANDREW SIMPSON)
- ( / ) 157-201 (GERALD SMITH)
- ( ) 157-4248 (GEORGE UDBARY)
- ( ) 157-4266 (MARY UDEARY)
- ( / ) 157-2610 (MICKEY WAKEFIELD)
- ( / ) 157-3138 (VICTOR WALTON)
- ( ) 157-2524 (GERALDINE WATSON)
- ( / ) 157-2545 (RAY WILSON)
- ( ) 157-2506 (JACK ZIMMERMAN)
- ( ) 157-4447 (BARBARA HUTCHINSON)
- ( ) 157-4545 (CHAUNCEY CURR)
- ( ) 157- (Bernard Dower)
- ( ) 157-4023 (ARNOLD DRESSEN)
- ( ) 157-3169 (DONNA LEE HARTLEY)
- ( ) 157-3170 (CALVIN FOX)

NOT  
GERMANE  
TO GODFREY

March 24, 1974

NSWPP meeting in San Diego; Cliff Ward visit San Diego;  
new political movement building in San Diego.

On Saturday night, March 23, 1974 the San Diego unit of the National  
Anarchist White People's Party held a meeting at 2562 Sumac in East San  
Diego. Present for this meeting were Tom Knight, Charles Martin, Rick  
Stanley, Vic Walton and Mickey Wakefield. The meeting began at 6 p.m.  
and ended at 9:30 but due to the tardiness of Walton and Wakefield, a  
planned newspaper distribution of the White Power publication was cancelled.  
Instead a couple of hundred copies of the newspaper were given to each  
activist to distribute each on his own at some future date. Movies of  
the January 19, 1974 NSWPP picket of the San Diego Jewish Community Center  
were shown. Walton, who photographed the event, said the FBI had apparently  
confiscated about half of the footage while it was being developed at  
Photomat.

The current balance in the San Diego unit's treasury is \$28 but the  
unit owes \$35 to Arlington and another \$20 to the Los Angeles unit for an  
overall balance of \$27 in the hole. Beginning in April, 1974 Knight is  
going to insist that each affiliate of the unit contribute a minimum of  
\$7 per month in dues.

It is known that Knight will be visiting the L.A. headquarters in  
El Monte on the night of March 30, 1974 to see the showing of Triumph of  
the Will. Martin will probably accompany him. An admission charge of \$1  
will be required of all who view this motion picture on that night.

Los Angeles unit leader Clifford Ward will be in San Diego on the  
night of Friday, April 5, 1974 and Saturday, April 6, 1974. He will likely  
stay overnight in the Knight home.

A crude letter of introduction has been made up for the San Diego  
unit of NSWPP by Walton and will be distributed along with White Power  
newspapers. Stanley has volunteered to write up a more professional  
looking letter, stating that he is quite proficient in the English language.

#### New Political Movement in San Diego

Without the knowledge of Tom Knight, and deliberately so, Vic Walton  
is trying to get a new political movement started in the San Diego area.  
The basis for the philosophy of this new movement stems from a book entitled  
Nature's Eternal Religion written by Ben Klassen. Klassen is founder of  
the Church of the Creator. The book is more than 500 pages in length but  
Klassen sold Walton 32 copies for only \$1 per book. Walton is quietly  
giving out these books to a selected few people in the San Diego area whom  
he believes will be receptive to the book's theme. Walton calls the book

"Mein Kampf". Walton originally learned of the book from [redacted] McDade but says McDade would not tell him directly from what [redacted] he came across it. Walton plans to have a meeting of people [redacted] are currently reading the book in his home on Thursday night, April 11, 1974 to discuss their opinions of what the book has to say. Both McDade and Walton believe the content of the book to be terrific.

Walton has recently been seeing a lot of a man named William Drexel. Drexel is said to be an ex-judge who was disbarred in December, 1973 due to his pro-Nazi ideas. Drexel is apparently very much opposed to the Federal Reserve System and during his judicial tenure, he once had the Treasurer of the State of Minnesota arrested. It is known that Drexel is currently earning about \$3,000 per month on a lecture circuit and that he also earns money by purchasing gold coins in Tijuana and selling them for a higher price in San Diego.

Tom Knight is planning to attend the next San Diego meeting of Bill Gale's Ministry of Christ Church to be held Thursday night, March 28, 1974. It is Knight's hope to try to sell copies of White Power newspaper at this meeting. Walton and Mickey Wakefield have also been requested by Knight to attend this affair.

Walton believes that Rick Stanley has a small amount of non-White blood in him and does not like the fact that Knight has accepted Stanley into the San Diego unit of NSWPP.

Vic Walton says that Barry Godfrey once gave him two cans of illegal powder. Because he suspected that the stuff was illegal, he claims to have disposed of it. Walton says he has information from a "pretty reliable source" that Godfrey is currently employed by the Sacramento Fire Dept.

Mickey Wakefield, Ray Wilson and Gerald Smith will all be going target shooting on Sunday, March 24, 1974 in the Keyes Creek Rancho Lilac area north of Valley Center. Wilson and Smith will have their families along with them.

That is all for now. Will be in touch when more develops.

Dandman 3-24-74

INFORMANT

# ATTENTION

HOW MUCH DO YOU KNOW ABOUT  
THE National Socialist ~~White~~  
People's Party?

Would you like to know more?

If so, write to "NEWS"

P.O. Box 3062  
San Diego,  
Calif. 92103

LE  
SWASTIKA

and we will have a party rep-  
resentative contact you.

We have an active  
unit of the party in San Diego and,  
if you are white and not a Jew, we  
invite you to help us to preserve,  
enlarge, defend & promote -

- White Civilization -

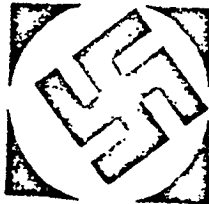

# THE FUTURE BELONGS TO US!

# Hearings Recess In Perjury Case

A hearing to determine whether a 1972 conviction of an alleged member of the Secret Army Organization should be overturned was continued yesterday pending receipt of answers from a former FBI agent involved in the initial investigations.

Superior Court Judge James C. Toothaker took the action at the request of Deputy Dist. Atty. Henry Mann and attorney Laurence C. Baldauf Jr., representing Calvin Fox.

Fox was convicted of perjury during the trials here. He was charged in connection with his denial that he was a member of the SAO, a right-wing paramilitary organization.

## MYSTERY WITNESS

A mystery witness, whom Baldauf said he might call for the writ of habeas corpus hearing, failed to materialize yesterday.

Baldauf had hinted that "Jerry Bush," whom he described as having testified before the Senate Watergate Committee, might appear despite a threat on his life.

Bush's name was not mentioned during the hearing yesterday.

## MOCK SHOOTOUTS

Other sources said Bush, 38, had lived here at one time, appearing in mock shootouts at the now-closed Frontier Village at Big Oak

Ranch in Harbison Canyon in 1962-64, and also in films made there.

He was said to be a freelance writer now, and was reported to have returned here about two months ago, staying until a week ago.

Mann and Baldauf agreed to submit written questions that would be put to former FBI agent Steve Christensen.

(Indicate page, name of newspaper, city and state.)

SAN DIEGO UN  
2/21/74

Date:  
Edition:  
Author:  
Editor:  
Title:

Character:  
or *Godfrey*

Classification:  
Submitting Office:

Being Investigated

170-286-15

SEARCHED	INDEXED
SERIALIZED	FILED
FEB 22 1974	
FBI - SAN DIEGO	

# '72 Perjury Witness Challenged

By BILL OTT

Howard Barry Godfrey, a former paid FBI informant and key prosecution witness in the series of 1972 Secret Army Organization trials here, yesterday was described by an attorney in Superior Court as a dangerous figure who, if not exposed in court, will be exposed by the Watergate Committee.

The allegation was by Laurence C. Baldauf Jr., attorney for Calvin Fox, who was convicted of perjury during the trials. He was charged in connection with his denial that he was a member of the SAO, a right-wing paramilitary organization.

Baldauf, who is seeking to overturn Fox's conviction, also raised the possibility of a mystery witness in his arguments before Judge James C. Toothaker for a writ of habeas corpus.

During arguments, he named the man as "Jerry Bush," saying he is "in San Diego." Baldauf also said Bush might testify, despite the fact that his life has been threatened.

Baldauf also had admitted into evidence a declaration by Bush over the objections of Deputy Dist. Atty. Henry Mann, who claimed the statement was not relevant

(Continued on B-4, Col. 1)

B-4—THE SAN DIEGO UNION

Wedn

## Informer In SAO Trials Challenged

(Continued)

to the proceedings. Baldauf later withdrew Bush's declaration with the consent of Mann and Toothaker. In withdrawing it, Baldauf said the contents should not be disclosed to the public because Bush had testified before the Watergate Committee and had been admonished not to make any public statements.

Mann, in making his earlier objection to admitting Bush's declaration, called the statement "highly inflammatory."

### CONCERN FOR SAFETY

Baldauf added that Bush was "concerned for his safety."

There were no further references to him, other than the arguments on admitting and then withdrawing his declaration.

Baldauf in his arguments attacked the credibility of Godfrey as a prosecution witness in the SAO trials, at one point saying "Mr. Godfrey is an arch criminal" who "unless taken into tow" may "kill someone," possibly the "President of the United States."

### PRICE TESTIFIES

Earlier, Baldauf called as a witness Deputy Dist. Atty. L. Forrest Price, who prosecuted Fox. When questioning Price, Baldauf asked him if he had been aware at the time that Godfrey had been involved in a "plan to

fly a drone into Air Force One (the presidential plane) as it was flown into San Diego."

Price said he was not aware of such a plan.

Baldauf also asked Price if he had any knowledge of a meeting between Godfrey and Donald Segretti at Gunsmoke Ranch in Harbison Canyon here. Segretti, 32, has pleaded guilty to one count of conspiracy and three counts of distributing illegal campaign literature in connection with the last presidential campaign. He was sentenced to six months in prison.

Price said he was not aware of such a meeting.

### DEFENSE ARGUMENTS

Baldauf is arguing that Fox was denied a fair trial and due process because the prosecution, at the time of his trial, withheld information and at least one witness who should have been allowed to testify for the defense — Steve Christensen, a former FBI agent to whom Godfrey reported when he was assigned to infiltrate extremist groups.

Fox was convicted of perjury on Dec. 6, 1972, after a nonjury trial before Judge Bensali Noon. Fox, 44, was the owner of an El Cajon service station at the time, an establishment allegedly searched by FBI agents.

(Indicate page, name of newspaper, city and state.)

SAN DIEGO UNION  
2/20/74

Date:  
Edition:  
Author:  
Editor:  
Title:

Character:  
or  
Classification:  
Submitting Office:

Being Investigated

170-286-150

SEARCHED \_\_\_\_\_ INDEXED \_\_\_\_\_  
SERIALIZED \_\_\_\_\_ FILED \_\_\_\_\_  
FEB 21 1974  
FBI - SAN DIEGO



by Sandman

INFORMANT

January 30, 1974

~~SUBJECTS: Memorandum on Ray Wilson; party for Ray's affiliates; Calvin Fox's accusations against Howard Barry Godfrey.~~

Ray Wilson, former commander of the San Diego unit of the National Socialist White People's Party, has moved to a new address very recently. His new address is 1831 Spalding Place. This is in the Normal Heights section of town not far from his former address. His telephone number is still the same as before, 291-3105.

Nazis To Hold Party in San Diego

On Friday evening, February 15, 1974 a party commemorating the third anniversary of the founding of the San Diego unit of the NSWPP will be held at 1831 Spalding Place, Ray Wilson's new address. Only five people will be invited. They are Ray Wilson, Gerald Smith, Tom Knight, Ron Eddy and Mickey Wakefield. These five were the original founders of the unit. The exact time for the beginning of this party is not yet known.

Calvin Fox's Accusations Against Barry Godfrey

The enclosed leaflet is apparently being circulated by Calvin H. Fox of El Cajon. However, the source of the particular copy enclosed here was Ray Wilson of San Diego. Fox comes on pretty strong against Godfrey.

That is about all for now. Will be in touch again soon.

Sandman 1-30-74  
INFORMANT

# Informer Is Linked Right-Wing Violence

By STEVEN V. ROBERTS  
Special to The New York Times

SAN DIEGO, June 23 — A leader of a paramilitary organization passed young leftists here for more than a year says that the group was partly created and financed by an informer of the Federal Bureau of Investigation enforcement officers and others.

According to the account of the informer, Howard Berr, Godfrey, participated in a shooting, as well as in several fire-bombings and burglaries. He was receiving regular payments from the F.B.I. for his services, it was said.

The account was provided this week by Jerry Lynn Davis, the former Southern California coordinator for the Secret Army Organization, a well-armed group that has been accused of the growth of another right-wing group, the Minutemen.

## Segretti Recognized

In another development this week, two members of the Secret Army Organization reportedly recognized a photograph of Donald H. Segretti, the young lawyer accused of organizing a Republican espionage campaign last year. According to the account, a local radical newspaper, the "Daily Worker," identified the man in the photograph as "Donald Summs," whom they said they met in the summer of 1971 at a shooting range frequented by members of the Secret Army Organization.

The two men reportedly said that "Summs" was present at a discussion among the right-wingers about the Republican National Convention, originally scheduled to be held in San Francisco last August before it was moved to New Orleans. "Summs" did not participate in the discussion but an unidentified companion did, according to the sources.

Mr. Segretti, who has been indicted for writing false campaign literature in the past, often used the name "Donald Summs" in recruiting espionage agents. It is also known that Mr. Segretti and the Secret Army Organization at different times discussed the idea of abducting individuals who might disrupt the convention. So far, there has been no firm evidence linking Mr. Segretti to the right-wing group.

Mr. Davis, a 31-year-old construction worker, spoke to a reporter after being released last Thursday from jail where he had been held pending his sentencing on charges of possession of explosives. The Secret Army Organization co-ordinator

had pleaded guilty and was granted probation.

According to Davis's account, the Secret Army Organization was formed in 1971 to train guerrillas who could organize a resistance movement should the United States be conquered by a foreign power. Howard Godfrey, the F.B.I. informer, was one of the six founding members and contributed the money used to print the group's recruiting literature, Davis said.

In addition, Godfrey was considered a "firebrand" within the organization and took a "more militant line" than most members, Davis said.

Godfrey told friends, and in some cases later testified in court, that he had participated in a series of violent actions against the rather small but vocal community of left-wing radicals in San Diego.

In one case, he admitted breaking into the offices of The Street Journal, a left-wing newspaper, and destroying printing equipment valued at several thousand dollars. In another case, he said he burglarized the Message Information Center, a counter-culture outpost, and stole their records.

Law enforcement agents say that Godfrey also performed several other burglaries and fire-bombed at least two cars belonging to radical sympathizers.

## Agent Hid Gun

According to his own court testimony, Godfrey was riding in a car on Jan. 6, 1972, when another member of the Secret Army Organization fired a shot into a house occupied by young leftists. The bullet shattered the elbow of a girl named Paula Tharp. Miss Tharp and other residents of the house were planning demonstrations at the Republican convention.

Godfrey took the gun used in the shooting and gave it to his F.B.I. contact. The agent hid it under his couch for six months until the Secret Army Organization member who shot Miss Tharp was finally apprehended by the police. The incident cost the agent his job.

Given Godfrey's contributions to the Secret Army Organization in time and money, Davis said, "you might say that the S.A.O. was a federally funded anti-poverty program for the right wing."

Some investigators here believe that Davis is exaggerating Godfrey's role somewhat, but they agree that "he was obviously a leader in the organization."

"AT 7:30 POINT IN TIME" THE OCTOBER 1973 ISSUE OF RAMPART MAGAZINE SAYS THAT GODFREY, THE FBI INFORMER, ADMITS HE WAS PLOTTING TO KILL PRESIDENT NIXON IN SAN DIEGO!

ISN'T IT JUST NICE THAT THE SAN DIEGO COURT JUDGES PUT TWO MEN IN PRISON FOR LIFE SOLELY ON THE WORD OF THIS CRIMINALLY INSANE INFORMER.

THIS CLEVER PARANOID, GODFREY, WAS WORKING UNDER L. PATRICK GRAY, NIXON'S APPOINTEE, WHO ADMITTED BURNING THE CONTENTS OF E. HOWARD HUNT'S WHITE HOUSE SAFE TO COVER UP THE C.I.A. PLOT TO SUBVERT THE CONSTITUTIONAL PROCESSES OF OUR GOVERNMENT.

THIS BUILDS STRONG SUSPICION OF LOCAL JUDICIAL CONNECTIONS TO THE WATERGATE SCANDAL.

I PROTEST! YOU, TOO, MUST PROTEST TO SAVE OUR REPUBLIC!

SINCERELY,

*Clwin*

900 BROADWAY

EL CAJON, CALIF 92021

CA'S GULF SERVICE

... this printing of the Appeals Court has overturned the conviction of one of the persons mentioned above--ON THE CREDIBILITY OF THE FBI WITNESS, GODFREY!!

... is dangerous to sell books against the ... last year.

Editor:

In May, 1972 when the Committee to Re-elect the President hired ex-FBI agents to bug 200 telephone calls at Democratic Headquarters (to save the country from communism), "Captain" Howard Barry Godfrey, another FBI operator, was spending his "expense" money at my service station, 900 E. Broadway in El Cajon, buying tires, batteries, and servicing for his 1951 Rambler (which he says he drove as the getaway car in the shooting incident at Professor Bohmer's home).

Since I have been an outspoken opponent of Chairman Nixon, it appears that "Captain" Godfrey was assigned to go to the county grand jury in June and name me as one of the members of his "Secret Army Organization" so that when I was subpoenaed to testify as a witness in the Yakopec trial, a bomb would be thrown at my station (on the same date as the subpoena), a rental truck destroyed, and a week later my contract with Hertz canceled.

It probably had nothing to do with my opposition to Nixon, but after I denied membership in the SAO ("an appendage of the FBI"), at the Yakopec trial, the almost all white (collar) county grand jury indicted me for perjury.

On Dec. 6, Judge Bonsall Noon found me guilty and sent me to jail for six months with five years probation

tacked on so I could be thoroughly watched by authorities for the remaining term-duration of the President...

Oh, incidentally, the only witness for the prosecution that I was an SAO member was "Captain" Godfrey. He had NO piece of corroborative evidence to produce to the court—only his mouth. It was his mouth (alone) which prompted Judge Conyers to become "outraged" over the FBI failure to produce evidence in the in the Yakopec trail. All evidence in my case was circumstantial (planted), also.

When I appealed the sentence Judge Noon first refused bail. Then after my attorney appealed that, he did consent to set bail at a reasonable (?) \$25,000! It was only \$10,000 in the beginning!

But don't get upset, gentlemen. This sort of political persecution is practiced in Communist Yugoslavia I know. My wife is from there. I just brought her out of her native country seven years ago!

She is petrified with fear of political provocateurs and informers again. Horrah for "Americanism"—Nixon-Gray style! Watergate! Watergate! Watergate! Who knows what lurks in the Watergate-West?

Calvin H. Fox, No. 589703  
P.O. Box 2952  
222 West C St.

WAS "CAPTAIN" GODFREY WORKING FOR THE FBI OR THE "COMMITTEE TO RE-ELECT THE PRESIDENT?" Turn the page for startling facts that point to the latter. You must decide from the circumstantial evidence, much the same way as a jury decides in a court trial.

WAS THE WATERGATE EVEN A SECRET AFFAIR? HOW MANY OF THEM WERE FRAMED? WILL WE EVER BE TOLD THE TRUTH?

# San Diego Link To Watergate Case Reported

Wednesday, January 24, 1973

WASHINGTON (UPI) — The Watergate trial was told yesterday that President Nixon's campaign managers, fearful of high Republicans, hired former White House aide G. Gordon Liddy to set up a \$250,000 "intelligence-gathering network." Job Stuart Magruder, former deputy director of the Committee for the Re-election of the President, testified yesterday that Mr. Nixon ordered the San Diego to Miami Beach as a result of Liddy's estimates of the number of antiwar demonstrators expected at San Diego. However, Magruder said he had never directed Liddy to San Diego or to try to bug San Diego headquarters at the Watergate. Liddy, who was one of five arrested June 17 inside Democratic headquarters, is charged with conspiracy, burglary and wiretapping in connection with the Watergate trial.

Campaign managers were concerned, he said, that it would be very difficult for the President to be re-elected if the conversion reflected the same violence that wracked the Democratic convention in Chicago. Campaign Treasurer Hugh W. Sloan Jr. testified he gave the money for Liddy's operation on orders from Magruder. When trial Judge John J. Sirica of U.S. District Court asked why Magruder had authorized the expenditure, Sloan replied: "I have no idea."

Under questioning, Sloan also confirmed for the first time that he left the Nixon campaign because of concern over the Watergate affair. Sloan also said he turned over \$20,000 in Nixon campaign contribution checks to Liddy to be converted into cash. This was done, Sloan said, because of the campaign finance reporting laws which subject individual contributions of more than \$25,000 to a gift tax. He said the five checks ranged in amounts from \$15,000 each to \$25,000.

Liddy and James W. McCord, Jr., who was one of five arrested June 17 inside Democratic headquarters, are charged with conspiracy, burglary and wiretapping in connection with the Watergate trial.

hello Mickey,

How are things with you? I am presently unemployed and so have a lot of time on my hands.

Knight told me of the grumbling in the ranks that Zimmerman started. He said you were the only one who really backed ~~him~~ <sup>him (Frank)</sup> up on this matter, and that some of the others took up for

NOT TO KNOW

Certainly, the Party is not a clandestine secret group with deep dark secrets to hide however there is definitely reason for maintaining a certain amount of security via the need to know principle. Our enemies and the authorities would like very much to break up the NSWPP. It is a known fact that agents infiltrate the Party, and anyone can be suspect in this regard. These agents are seeking information on who we are, who gives money, what our financial status is, what we are planning for activities, and in general, "what we are up to". There are things of a sensitive nature that need only concern those directly involved. Furthermore, the NSWPP

is not a democratic debating society  
or a gossip club for sneaky gawkers,  
it is an authoritarian political army.  
In any army engaged in such a  
battle as ours, it is only common sense  
that each officer, NCO, and trooper  
should only need to know the things which  
would enable him to do his job. ~~Whoever~~  
heard of army leaders revealing all of  
their battle plans to the troops before  
engaging the enemy?

~~NOT GOOD FIRE~~  
I'm glad you understand this principle.

Knight said he now has a .22 pump action  
carbine. This is not ideal, but I'm happy  
that he has this added fire power.

Has Gerald told you of our plans for  
a celebration? It will commemorate the 3<sup>rd</sup>  
year of the San Diego Unit. (Founded Feb 14, 1971)  
we were thinking of having it at my place on  
the 15<sup>th</sup>. You, me, Gerald, R. Eddy and Knight  
would be the ones invited. As of this  
Friday my new address is:

1831 Spalding Pl.  
San Diego, Ca 92116

phone unchanged.

Randy

Date prepared

11/29/73

Date received

Received from (name or symbol number)

Received by

11/20/73

SD 2157-E

INFORMANT

SA EARL M. PETERSEN

Method of delivery

(See appropriate blocks)

in person

by telephone

by mail

orally

recording device

written by informant

If orally furnished and reduced to writing by Agent:

Date

Date of Report

11/17/73

Dictated

to

Date(s) of activity

Transcribed

11/17/73

Authenticated by Informant

11/17/73

Brief description of activity or material

NSWPP Demonstration in Los Angeles 11/17/73

File where original is located if not attached

SD 170-512A

\* INDIVIDUALS DESIGNATED BY AN ASTERISK (\*) ONLY ATTENDED A MEETING AND DID NOT ACTIVELY PARTICIPATE. VIOLENCE OR REVOLUTIONARY ACTIVITIES WERE NOT DISCUSSED.

Informant recorded on a card index by

or date

Remarks:

Further dissemination by offices receiving copies of this report are left to the discretion of those offices.

Index to 100-15355: Mark Roberts, alias of Jerry Busch.

100-15355\*

- (1) SD 170-512A - 166
- (2) Alexandria (157-1)
- (2) Los Angeles (157-9)
- (2) Phoenix
- (2) San Francisco
- (1) 157-23 (NSWPP)
- (1) 157-132 (DON EDDY)
- (1) 157-3300 (PETER GAVIN)
- (1) 157-4220 (MIKE JOHNSON)
- (1) 157-3060 (FRANK KEAR)
- (1) 157-3000 (CAROL KNIGHT)
- (1) 157-3000 (FRANK KNIGHT)
- (1) 157-4131 (CHARLES MYREIN)
- (1) 157-4220 (MIKE MOORE)
- (1) 157-201 (GERALD SMITH)
- (1) 157-3010 (NICKY WAREFIELD)
- (1) 157-2133 (VEC WALTON)
- (1) 157-2845 (RAY WILSON)
- (1) 157-2806 (JACK ZIMMERMAN)
- (1) 157-4018 (Joseph Benintende)
- 1 157- (Walt Kendall)
- 1 157-4350 (Bob Nee)
- 2 - 157-4252 (Cari Schmidt)
- 1 - 157-2532 (Sue Sullivan)
- 1 - 157-2933 (Stanley McDade)

- 1- 100-15355 (Jerry Busch)
- 1-157-3017 (George Hoover)
- 1- 157-3012 (Frank Work)
- 1- 157-3300 (Peter Gavin)
- ① 170-286 (Howard Barry Godfrey)

Block Stamp

170-286-148

SEARCHED	INDEXED
SERIALIZED	FILED
NOV 27 1973	
FBI - SAN DIEGO	

AW

EMPIER

## Nazi demonstration in Los Angeles.

Saturday, November 17, 1973 the Storm Troopers section of the Socialist White People's Party staged a demonstration in Los Angeles. The theme of the demonstration was "Dump Israel" and the demonstration was conducted on the steps of the Federal Building. The demonstration began at about 1:30 p.m. and was concluded by 2:35 p.m. Present at this affair were affiliates from Los Angeles, San Diego, Phoenix, Oakland, Tracy and San Francisco.

From San Diego the following activists took part: Ray Wilson, Tom Knight, Mickey Wakefield, Charles Martin, Ron Eddy, Walt Kendall, Bob [unclear] and Carl Schmidt. Allen Vincent, leader of the San Francisco unit, was on hand, as was Elton Hall from Phoenix and a man identified only as Scott from Oakland. Scott also had been in the anti-Bradley demonstration of July 1, 1973.

One Army truck from Northern California was used in this demonstration. In it 25 of the ST piled into the rear for the trip to and from the Federal Building, disembarking near the end of San Pedro Street and re-entering the truck directly in front of the demonstration site. Altogether 26 Storm Troopers in uniform took part in the protest along with about 7 or 8 non-uniformed supportive personnel. Also, two uniformed ST drove the Nazi truck around the area during the entire event. In total it can be said that about 35 NSWPP affiliates were involved in various roles. Sue Sullivan was one of the principal photographers. Two young (teenaged) girls whose faces had not been previously seen were also on hand. One had long blond hair and was extremely good looking. The dark-haired girl was not as attractive physically although she had a rather sexy look about her.

There were no incidents of violence during this affair. It was raining and the Jewish Defense League did not make its expected appearance. However, a JDL man named Barry Krugel was seen to drive past the Federal Building several times during the demonstration. Also, after the Nazis had boarded their truck to leave the scene, Irv Reuben is reported to have showed up in front of the Federal Building along with Krugel and possibly one or two others. Consequently, the Nazis drove around the block and shouted at this group, "Irv Reuben is a yellow swine". There was no visible response from the harrassed group. Signs carried by the demonstrators read "Zionism is treason", "No more arms for Israel", "No troops for Israel", "America doesn't need Israel" and "Dump Israel".

ional Commander the NSWPP Matt Koehl led the march. With  
e Captain Clifford Ward, Dan Stewart, Phil Fogarty, David Kerr,  
n identified only as Matthews, Corey, and Cummings. Joe Tommasi  
een loitering near the front fence of the El Monte headquarters  
ng to talk with some of the ST. Freeman Fox was also in uniform.

### Strategy

Captain Ward's strategy in this demonstration was as follows. Since  
the JDL usually attacks the Nazis from the rear, he put some of his best  
and most willing fighters in that area. Two teams each containing four  
men were assigned to the area officially designated as being the rear.  
Included in this group were Cummings, Kendall and Wakefield and it is  
notable that Ron Eddy was assigned to the very last position of the rear,  
traditionally the most dangerous. A special squad was given the task  
of defending Koehl and this included Ward, Wilson and Stewart. Ward  
stated that current intelligence indicated the JDL was going to change  
its strategy during this demonstration. He said he had learned that  
they were planning to block the sidewalk. Ward went on to say that he  
intended to change tactics to counter this. He said, "Stewart and I  
will be leading the way and we are going to elbow them aside". "This  
time we are going to go right through them instead of around them".  
"I just hope there are enough Jews to go around for everyone when the  
fight starts".

The ex-attorney for the NSWPP was a participant in this demonstration.  
When it was over and everyone had returned to the headquarters, a lively  
discussion was begun concerning the Jews. White declared, "The Jews  
are nothing but a bunch of wild animals which should all be hunted down".

One of the regulars of the ST confided that the buckshot placed  
in the shotguns to be used in the defense of the headquarters have been  
treated with cyanide to assure death to any attackers.

Ron Eddy said he believed in treating even Blacks with justice,  
saying that he would not believe it right to lynch even a wretched  
nigger criminal" without a fair trial. "But", he continued, "where  
Jews are concerned I believe in just killing every last one of them  
because they're all no good".

Walt Kendall stated that when it appeared his two sons were about  
to be drafted during the Vietnam War, he went to their draft board and  
warned those present that "If my sons go to Vietnam and get shot, I will  
personally come in here and execute every last one of you". He said his  
sons never were drafted.



~~NOT RECORDED~~  
There are some more notes on the previous night the San Diego meeting  
number 16.

### Phony Name Given

It has been learned that Jerry Busch was present at Vic Walton's home in La Mesa on the night of the 16th. He gave Commander Koehl the alias name "Mark Roberts" when the commander asked who he was. Busch appears to be friendly with Stan McDade and is said to have been a close friend of George Hoover in the Secret Army Organization. This same trick had been used by Mike Johnson of La Mesa when he was first introduced to Joe Tommasi last July. At that time he gave his name as being Kuychendahl (pronounced Kirkendall).

~~NOT RECORDED~~  
Also on the night of the 16th Walt Kendall asked Koehl if he believed John Patler had killed G.L. Rockwell. Koehl answered with an emphatic "Yes". Koehl said that he believes Patler will be paroled in about three or four more years. Kendall then stated, "Then he has that long to live". Koehl asked "What?" and Kendall repeated, "Then that's about how much longer he can expect to live". Koehl then said that while it was obvious Patler was the trigger man, he thinks others were also involved. Ron Eddy then stated that he has a letter written by Rockwell in about 1964 or 1965 in which a great deal of its 2 1/2-page length was devoted to a discussion of Patler. "Even that far back", said Eddy, "Rockwell had Patler pretty well figured out according to what he wrote in this letter".

Also, I just remembered that Mr. Work stated he was from Chicago but whether he meant originally or recently I don't know.

### NSWPP Meeting in San Diego

A meeting of the San Diego unit of NSWPP will be held at the home of Tom Knight on Friday, November 30, 1973 at 7 p.m.

### Activities of Pete Gavin

Pete Gavin asked Mickey Wakefield for his address and telephone number. Gavin says he has a sister living in Escondido at 1333 Magnolia and he sometimes visits her there. She just recently moved to that address. Coincidentally, she lives just a few doors from Donna Looper, an acquaintance of Wakefield's.

Also, one of the L.A. activists asked for Wakefield's address & phone number today. He stated that his brother would soon be moving to Escondido and would likely wish to get in touch with a party comrade there. Wakefield gave out the desired information but the name of the man to whom it was given is not known. His face has been seen there before, however. Interruptions of an immediate nature prevented the obtaining of his name.

Ron Eddy of Poway states he has all of the coming week off and that he desires to accompany Wakefield and Knight to their scheduled trial for disturbing the peace on Wednesday, November 21, 1973. Eddy also reiterated his hope that bail on George Hoover will be lowered sufficiently to get him out. Eddy said he would be willing to borrow money from his credit union and put up the equity in his house as collateral to get Hoover out of jail. Eddy says that the only way to prevent people from serving as informants for the FBI is to make examples of some of them. Eddy believes that Hoover would murder Barry Godfrey if he could find him and I think he is hoping something like that will happen. When it becomes necessary for Godfrey to return to San Diego, I cannot over-emphasize the importance of maintaining heavy security for him. If he thought he had half a chance of getting away with it, I believe Eddy himself would murder Godfrey just to "make an example".

That is about all that is known to have happened in the past couple of days. I hope it is of use to you.

Sandman 11-17-73  
INFORMANT



# STORMTROOPERS

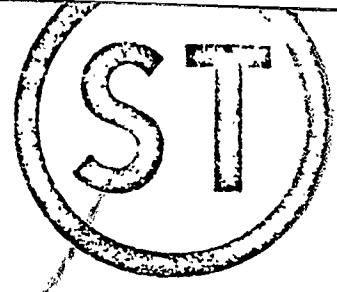

## Application Form

*NOT GERMAN*

Type or print in ink.

Name \_\_\_\_\_  
Last First Middle

Street \_\_\_\_\_

City \_\_\_\_\_ State \_\_\_\_\_ Zip \_\_\_\_\_

Telephone *70* \_\_\_\_\_ Occupation \_\_\_\_\_

Age \_\_\_\_\_ Married? \_\_\_\_\_ Height \_\_\_\_\_ Weight \_\_\_\_\_

Physical condition \_\_\_\_\_

List any disabilities \_\_\_\_\_

Military experience \_\_\_\_\_

List all organizations you belong to \_\_\_\_\_  
Branch Specialty Rank

Are any legal charges pending against you? \_\_\_\_\_ If so, give full details. \_\_\_\_\_

Can you regularly take part in ST activity with an organized unit? \_\_\_\_\_ Which one? \_\_\_\_\_

Can you occasionally take part in ST activity with an organized unit? \_\_\_\_\_ Which one? \_\_\_\_\_

Can you move to an ST command area? \_\_\_\_\_ Which one? \_\_\_\_\_

I, the undersigned, a White non-Jewish male, do hereby swear that all of the foregoing information in this application is complete and correct to the best of my knowledge, and that my sole purpose in applying for membership in the Stormtroops is a desire to fight for the National Socialist cause.

I also swear that I am not a fugitive from justice, a user of narcotics or a homosexual and that I do not belong to any anti-National Socialist group or organization.

I further swear that I am willing to give my unconditional loyalty and obedience to the Commander of the Stormtroops and the National Socialist movement, Matt Koehl.

Signed \_\_\_\_\_

Date \_\_\_\_\_

NOT TO

CONFIDENTIAL  
GOOD FOR 27

-----  
*This space for official use only.*

Probation date \_\_\_\_\_

Rejection date \_\_\_\_\_

Swear-in date \_\_\_\_\_

Termination date \_\_\_\_\_

Status \_\_\_\_\_

Reason \_\_\_\_\_

Unit \_\_\_\_\_

Authorizing officer \_\_\_\_\_

By order of \_\_\_\_\_

ST 001 7/71

Date prepared

11/12/73

Date received

11/12/73

Received from (name or symbol number)

SD 170-512A

Received by

SA Carl M. Peterson

Method of delivery (check appropriate boxes)

in person  by telephone  by mail  orally  recording device  written by Informant

If orally furnished and reduced to writing by Agent:

Date

Date of Report

11/10/73

Dictated \_\_\_\_\_ to \_\_\_\_\_

Date(s) of activity

11/9/73

Transcribed \_\_\_\_\_

Authenticated by Informant 11/10/73

Brief description of activity or material

San Diego NSW RP meeting 11/9/73

File where original is located if not attached

SD 170-512A

\* INDIVIDUALS DESIGNATED BY AN ASTERISK (\*) ONLY ATTENDED A MEETING AND DID NOT ACTIVELY PARTICIPATE. VIOLENCE OR REVOLUTIONARY ACTIVITIES WERE NOT DISCUSSED.

Information recorded on a card index by \_\_\_\_\_ on date \_\_\_\_\_

Remarks:

- (1) SD 170-512A - 152
- 1- 157-1820 (YAKOPEC)
- 1- 157-3861 (DAVE ALDRIGHT)
- 1- 157-3559 (JEFF DIXON)
- 1- 157-3793 (CURT HARDING)
- (1) 157-23 (SMER)
- (1) 157-152 (RON BODDY)
- ( ) 157-3800 (PETER SMYTH)
- (1) 157-4220 (MIKE JOHNSON)
- (1) 157-3860 (FRANK KILG)
- ( ) 157-3104 (CAROL KITCHEN)
- (1) 157-2898 (FRANK KILG)
- (1) 157-4181 (CHRISTOPHER MORGAN)
- ( ) 157-4220 (KOLLE MOORE)
- ( ) 157-291 (GARYO SMITH)
- (1) 157-2610 (MURRAY WAINFIELD)
- (1) 157-3128 (VIC WALTON)
- (1) 157-2545 (RAY WILSON)
- ( ) 157-2505 (JACK ZIMMERMAN)
- ( ) 157-4018 (Joseph Benintende)
- 1- 157-4252 (CAROL SMITH)
- 2- 157-152 (BOB KNOW)
- 1- 157-3017 (George Horner)
- 1- 170-252 (M. H. Fry)

FURTHER DISSEMINATION IN LOS ANGELES IS LEFT TO THAT OFFICE

TO OPEN NEW 157 CASE ON BOB KNOW TO IDENTIFY AND ADVISE USE

Block Stamp

170-186-147

SEARCHED \_\_\_\_\_ INDEXED \_\_\_\_\_

SERIALIZED \_\_\_\_\_ FILED \_\_\_\_\_

NOV 15 1973

FBI - LOS ANGELES

AR

SUBJECT: NSWFP meeting in San Diego.

On Friday night, November 9, 1973 a meeting the San Diego unit of the National Socialist White People's Party was held in the home of Tom Knight in East San Diego. It began at 7 p.m. and ended at about 10:23 p.m. During the course of the meeting, 250 White Power newspapers were distributed in the East San Diego area. Streets covered by this distribution included Trojan, 56th, 57th, 58th, Adelaide, Vale Way and a number of others. Present for this meeting were Ray Wilson, Tom Knight, Ron Eddy, Mickey Wakefield, Vic Walton, Carl Schmidt, Charles Martin and a new man named Bob Know or No (don't know the spelling, just the pronunciation)..

Bob Know

Bob Know appears to be in his early 20's, stands about 5-10, is fair trim but with just a slight tendency toward the heavy side, has reddish-brown, short-cropped hair, sideburns which come down nearly to the base of his ears and which are thin and squared off at the bottom. He wears glasses and is currently in the U.S. Navy. In about one month he will be leaving the San Diego area and returning to his home town. He did not state the name of the place from which he comes but he has a very definite Southern twang to his voice. He seems like a quiet person. He hopes to get involved with the NSWFP in his home area.

Curt Harding

Vic Walton says that Curt Harding telephoned him from Phoenix on about Wednesday the 7th of November. Harding claims he could not find the Phoenix unit and wanted Walton to help him do so. Walton plans to get Elton Hall's new phone number in Phoenix and pass that on to Harding. Also, Harding has promised to write letters to two area high school students who were briefly involved with the NSWFP earlier this year. The two are Jeff Dixon and Dave Albright. They attend Clairemont and University High Schools. Harding is going to urge them to get involved with the Nazis again in San Diego.

Ray Wilson's Speech

Much of what Ray Wilson had to say concerned an article which appeared in a publication called Mike Sheele's Spectrum West for August, 1973. The title of the article was "The Nazis in America" and the article was a scathing attack toward the Nazis in places; it also pointed out what, in Wilson's opinion, are some very good reasons why the NSWFP is growing. To realize...

Article was about as derogatory toward the Nixon Administration as toward the Nazis and revealed a definite link between the two. In the article there appeared photographs of the anti-Bradley demonstration in Los Angeles of July 1, 1973.

Wilson also reiterated his earlier stated desire that all NSWFP affiliates read How to Prepare for the Coming Crunch. Wilson said, "While I don't like to see calamities hit people, politically I welcome them." "The only way you can wake up the American people is to hit them over the head with a sledgehammer." "Only when they are economically hit in the guts will they respond to us." "But I think it is clear to us now that a depression is coming."

Wilson also discussed people who have been in and out of the NSWFP. He said that he had made a study of the 25 or so he knew of who had been but were no longer active with the San Diego unit. He said, "Four or five quit due to genuine disillusionment, four or five left the area, and twelve left due to personal cowardice." For the latter group he used two examples namely, Frank Ferr of El Cajon and Mike Johnson of La Mesa. He also hinted that Ferr may have been an agent. Carl Schmidt then spoke up in defense of some of the younger defectors and said that perhaps "we didn't nurse them along sufficiently, perhaps we failed them instead of the other way around." Wilson's response was that you can only nurse people so far and you can never make a fighter out of a coward.

#### Ron Eddy

Ron Eddy had a very great deal to say on this night. He covered two subjects--morality and especially the FBI.

He spoke of some of the sleazy looking places on South Broadway in San Diego. He said, "They're full of White girls being used as whores by nigger pimps and nigger customers." "South Broadway is one huge whore house." "I'd like to take a submachinegun and walk into those places and just clean house." He went on, "Yakobec might just as well have done it that way because he's up the river for just as long as if he'd killed someone." Eddy said that if the bail on George Hoover is lowered sufficiently, he will bail him out. He said, "And if I can find out where Barry Goldfrey is, I'll point Hoover in that direction because I think he's the kind of man who'll do any kind of thing."

Many things were said about "FBI agents" which is claimed to be carried out from both agents and informants of that organization. "I wish we could do it all over again and do it in a better way." He said, "I wish we could

one of our people over to the IRA (Irish Republic<sup>an</sup> Army) to see how they do things." "They have no more than 500 men but look at all the havoc they get away with." Wilson pointed out to Eddy that the IRA also has a friendly populace helping them. Eddy then said that one thing which nags him is the fact that no Nazi has ever tried to assassinate Irv Reuben, leader of the Los Angeles Jewish Defense League. Eddy said, "It should be done in retaliation for his (Reuben's) attempt on Tommasi's life."

Stepped Up Literature Distributions

In the future, in addition to holding meeting-distribution combinations every other Friday, the San Diego unit plans to hold get-togethers for the sole purpose of getting out more literature and White Power newspapers. Wakefield was the first to volunteer to help on this job and the others said they would if they could. Wilson also asked who would participate in next Saturday's L.A. demonstration and, to a man, they said they would be present "if possible".

That's about all for now. I hope this will be of help to you.

Sandman 11-10-73

INFORMANT



Date prepared

11/12/73

Date received

11/1/73

Received from (name or symbol number)

INFORMANT  
SD 2157-E

Received by

SA Earl M. Peterson

Method of delivery (check or appropriate initials)

in person  by telephone  by mail  orally  recording device  written by Informant

If orally furnished and reduced to writing by Agent:

Date

Dictated \_\_\_\_\_ to \_\_\_\_\_

Transcribed \_\_\_\_\_

Authenticated by Informant 10/20/73

Date of Report

10/20/73

Date(s) of activity

9/8/73

Brief description of activity or material

Info re NSW 88 discussion re  
Hodgson

File where original is located if not attached

SD 170-572A

\* INDIVIDUALS DESIGNATED BY AN ASTERISK (\*) ONLY ATTENDED A MEETING AND DID NOT ACTIVELY PARTICIPATE IN VIOLENCE OR REVOLUTIONARY ACTIVITIES WERE NOT DISCUSSED.

Information recorded on a card index by \_\_\_\_\_ on date \_\_\_\_\_

Remarks:

(1) SD 170-572A - 144

(1) 170-286 (Hodgson)

- (1) 157-23 (NSWPP)
- ( ) 157-157 (RICH EDDY)
- ( ) 157-336 (CHARLES MARTIN)
- ( ) 157-4223 (ALICE JOHNSON)
- ( ) 157-3366 (FRANK KERR)
- ( ) 157-3184 (CAROL KNIGHT)
- ( ) 157-2293 (FRANK KNIGHT)
- ( ) 157-4131 (CHARLES MARTIN)
- ( ) 157-223 (RICK ROSS)
- (1) 157-202 (GERSHON)
- (1) 157-2510 (WICKY WAREFIELD)
- ( ) 157-3136 (VIC WALTON)
- (1) 157-2545 (RAY WILSON)
- ( ) 157-2506 (JACK ZILBERMAN)
- ( ) 157-4018 (Joseph Benintende)
- (1) 157-2733 (STANLEY W. PAGE)

Emp: 5  
(7)

Block Stamp

170-286-144

SEARCHED	INDEXED
SERIALIZED	FILED

12

~~Set by Sandman~~ INFORMANT

SUBJECT: Whereabouts of Howard Barry Godfrey.

Recently the name of Barry Godfrey has been very much on the minds and lips of both left and right-wing extremists.

To begin with, Stanley McDade of Spring Valley claims to have seen Godfrey in Los Angeles on the night of September 8, 1973. His sighting is said to have occurred at a meeting of the National Socialist White People's Party in El Monte. This was the meeting at which Cliff Ward took over command of the NSWFP's Los Angeles headquarters from Joe Tommasi.

Ray Wilson, San Diego unit leader of NSWFP, tends to discount McDade's claim. Wilson said, "McDade is always coming up with wild stories and this is just one more of them".

A staff member of the pro-Communist San Diego Door claims to have succeeded in locating Godfrey in the Sacramento area. No more than that is known about the leftist attempt to find Godfrey.

Relating back to McDade's story, Gerald I. Smith of Santee has a theory. He believes that McDade may be sincere in what he says but that he mistook Mickey Wakefield of Escondido for being Barry Godfrey. Smith states that in his opinion, Godfrey and Wakefield are fairly similar in appearance.

Smith had more to say on the subject of FBI infiltration of left and right-wing extremist organizations. He said, "Actually it is a mistake to blame people like Godfrey for this situation. Even the individual FBI agents in the field are not really to blame. The informants and agents of the FBI are only doing what they are told. The ultimate blame lies with the dossier-gatherers back in Washington, D.C." Smith went on to say that he has nothing against the police for trying to be informed about the NSWFP and its opponents. He feels that the sole purpose of the police in doing this is to prevent trouble from starting. However, Smith feels that the attitude of Federal agents is less desirable. He said, "They (the FBI) seem to feel that groups like the NSWFP should somehow be outlawed".

That is about all that is known about the current concern with Barry Godfrey and the most recent attitudes of Gerald Smith. Will there be any further developments.

Sandman 10-20-73  
INFORMANT

# SAO'S HOOVER GETS REVERSAL

The man convicted of wounding former door staffer Paula Tharp while shooting into former economics professor Peter Bohmer's house, has had his conviction reversed by the Fourth District Court of Appeals.

George Mitchell Hoover, Secret Army Organization (SAO) member, was sentenced last February to from five years to life. His conviction was almost entirely due to the testimony of Howard Barry Godfrey, former SAO leader who later surfaced as an FBI informer. Godfrey was the driver of the car used in the shooting of Bohmer and Tharp's Ocean Beach home.

The Appeals Court ruled that Judge William Low's decision not to let the jury determine Godfrey's credibility (as both informer and accomplice) was in error. In addition, the court suggested that Godfrey's role in the shooting should have been grounds for prosecution. The fact that Godfrey was not charged at the time left few people who weren't at least a bit suspicious.

So George Hoover now goes back to Superior Court, where a jury will decide whether Godfrey's testimony was credible. And if they find it's not, a new trial might be ordered. All this would mean that Howard Barry Godfrey, who has been in relative hiding since the SAO trials, would return to San Diego to testify.

Meanwhile, sources inside the District Attorney's office say that they plan to appeal the conviction reversal.

(Indicate page, name of newspaper, city and state.)

SAN DIEGO DAILY  
— 11/8-22/73  
Volume 5 Issue

Date:  
Edition:  
Author:  
Editor:  
Title:

Character:  
or  
Classification:  
Submitting Office:

Being Investigated

*done  
Clark signed  
make Xerox copy  
in 170-286*

157-10077  
170-286-  
SEARCHED INDEXED  
SERIALIZED FILED  
NOV 13 1973  
FBI - SAN DIEGO  
*ll*

# Appeal Filed In Conviction Of Secret Army Key Figure

An appeal has been filed with the Fourth District Appellate Court, challenging the 1972 conviction of William Francis Yakopec, a key figure in the Secret Army Organization trials.

Yakopec, 31, was sentenced on Oct. 24, 1972, to one year to life in state prison after his Oct. 2 conviction on charges of assault with intent to commit murder, assault with a deadly weapon on a police officer, simple assault and possession of explosives.

The charges stemmed from an investigation of activities allegedly linked to the right-wing paramilitary Secret Army Organization, including the June 19, 1972 bombing of the Guild Theater, an adult movie house that showed sex-oriented films. No one was injured.

Yakopec, just before his sentencing, made a dramatic confession, saying he had lied on

the witness stand when he denied bombing the theater.

Fred Hetter, Yakopec's attorney, said he has appealed his client's conviction on grounds of errors in trial and in pretrial motions.

Hetter said he was wrongfully denied the right to suppress evidence on the basis that he was not allowed to question undercover policeman Rubien Brandon on affidavits in support of a search warrant for Yakopec's El Cajon residence. Further, Hetter said, he was not allowed to question Brandon on the reliability of the key prosecution witness, Howard Barry Godfrey, a former San Diego city fireman who was a paid FBI informant assigned to infiltrate extremist right-wing groups.

Hetter said Godfrey's reliability as a witness was open to question because he had partic-

ipated in four felonies, involving the setting off of an incendiary device in his yard, and possession and sale of illegal explosives.

He said further that he had requested instructions from Superior Court Judge Robert W. Conyers, the trial judge, on entrapment, but his request was denied. Hetter added that Yakopec's case was one of entrapment.

On Yakopec's confession before sentencing, Hetter commented that it would be difficult to go to trial on the basis of a confession, and, if a new trial does develop, the defense would concentrate on the question of entrapment.

Yakopec was one of several persons indicted by the county grand jury in its investigation of Secret Army Organization activities. The series of trials that resulted captured wide public attention.

(Indicate page, name of newspaper, city and state.)

*San Diego Union*  
*9/26/73*

Date:  
Edition:  
Author:  
Editor:  
Title:

Character:  
or

Classification:  
Submitting Office:

Being Investigated

*copy  
made for  
157-2815 (SAO)  
170-286 (Godfrey)  
EMJ*

*157-1820*  
*170-486-144*  
SEP 28 1973  
FBI - SAN DIEGO

(Mount Clipping in Space Below)

# hard times....

Has the news media blackout in San Diego got you down? Well, it's got us down too. Last issue the DOOR ran a story about the activities of CREEP spy Donald Segretti in San Diego. The story was important enough for the *New York Times* (see below) to pick it up. In addition, it has been reprinted in the *Washington Post* and a number of other places.

All week the DOOR has been getting phone calls from around the country about our story. It has all been very rewarding — but also very frustrating. Here we are sitting on a major news story and with the exception of KGB — no San Diego news outlet has picked it up, or even called us to check the story out!!!

The DOOR will continue its investigation into San Diego's Watergate connections. And we will print whatever we find out! We hope that the other news media in San Diego will get off their asses and do some work. We will be glad to take them under our wing and give them a lead or two. In any event, you can read all about it right here in the DOOR.

We are reprinting the article from the *New York Times* so our readers can enjoy it along with us and so the sceptics can see that somebody takes us seriously.

(Indicate page, name of newspaper, city and state.)

SAN DIEGO DOOR

July 3-17

Vol 5 Issue 2

Date:

Edition:

Author:

Editor:

Title:

Character:

or

Classification:

Submitting Office:

Being Investigated

75-170-286

14/3

SEARCHED	INDEXED
SERIALIZED	FILED
JUL 3 1973	
FBI-SAN DIEGO	

# F.B.I. Informer Is Linked To Right-Wing Violence

By STEVEN V. ROBERTS

Special to The New York Times

SAN-DIEGO, June 23—A leader of a right-wing, paramilitary organization that harassed young leftists here for more than a year says that the group was partly organized and financed by an informer for the Federal Bureau of Investigation. Law enforcement officers and others familiar with the situation corroborated his account.

The informer, Howard Berry Godfrey, participated in a shooting, as well as several fire-bombings and burglaries, while receiving regular payments from the F.B.I. for his services, it was said.

This account was provided this week by Jerry Lynn Davis, the former Southern California coordinator for the Secret Army Organization, a well-armed outgrowth of another right-wing group, the Minutemen.

## Segretti Recognized

In another development this week, two members of the Secret Army Organization reportedly recognized a photograph of Donald H. Segretti, the young lawyer accused of organizing a Republican espionage campaign last year. According to The Door, a local radical newspaper, the two rightists identified the man in the photograph as "Donald Simms," whom they said they met in the summer of 1971 at a shooting range frequented by members of the Secret Army Organization.

The two men reportedly said that "Simms" was present at a discussion among the right-wingers about the Republican National Convention, originally scheduled to be held in San Diego last August before it was moved to Miami Beach. "Simms" did not participate in the discussion but an unidentified companion did, according to The Door's sources.

Mr. Segretti, who has been indicted for distributing false campaign literature in Florida, often used the name "Donald Simmons" in recruiting espionage agents.

It is also known that Mr. Segretti and the Secret Army Organization at different times, discussed the idea of abducting radicals who might disrupt the convention. But so far, there has been no firm evidence linking Mr. Segretti to the right-wing group.

Davis, a 31-year-old, construction worker, spoke to a reporter after being released from Federal House of Detention here last week. He had been held pending his confinement on a charge of possession of explosives. The Secret Army Organization co-ordinator

had pleaded guilty and was granted probation.

According to Davis's account, the Secret Army Organization was formed in 1971 to train guerrillas who could organize a resistance movement should the United States be conquered by a foreign power. Howard Godfrey, the F.B.I. informer, was one of the six founding members and contributed the money used to print the group's recruiting literature, Davis said.

In addition, Godfrey was considered a "firebrand" within the organization and took a "more militant line" than most members, Davis said.

Godfrey told friends, and in some cases later testified in court, that he had participated in a series of violent actions against the rather small but vocal community of left-wing radicals in San Diego.

In one case, he admitted breaking into the offices of The Street Journal, a left-wing newspaper, and destroying printing equipment valued at several thousand dollars. In another case, he said he burglarized the Message Information Center, a counter-culture outpost, and stole their records.

Law enforcement agents say that Godfrey also performed several other burglaries and fire-bombed at least two cars belonging to radical sympathizers.

## Agent Hid Gun

According to his own court testimony, Godfrey was riding in a car on Jan. 6, 1972, when another member of the Secret Army Organization fired a shot into a house occupied by young leftists. The bullet shattered the elbow of a girl named Paula Tharp. Miss Tharp and other residents of the house were planning demonstrations at the Republican convention.

Godfrey took the gun used in the shooting and gave it to his F.B.I. contact. The agent hid it under his couch for six months until the Secret Army Organization member who shot Miss Tharp was finally apprehended by the police. The incident cost the agent his job.

Given Godfrey's contributions to the Secret Army Organization in time and money, Davis said, "you might say that the S.A.O. was a federally funded anti-hippy program for the right wing."

Some investigators here believe that Davis is exaggerating Godfrey's role somewhat, but they agree that he was obviously a leader in the organization.



Photo by Vince Compagnone

(Indicate page, name of newspaper, city and state.)

SAN DIEGO DOOR

July 3-17

Vol 15 / ISSUE 2

# TRIALS

Bill Ritter

## JERRY LYNN DAVIS

The former Southland coordinator for the Secret Army Organization (SAO) has been placed on three years probation. Superior Court Judge Franklin Orfield pronounced sentence last June 21 on Jerry Lynn Davis, former SAO chieftain who was found guilty of possessing inflammable material. Davis was originally charged with possessing explosive devices.

After spending a total of 134 days in jail (including a 90-day stint in Chino for a diagnostic study), Davis was given probation because of "good probation recommendations."

In an exclusive interview with the DOOR Davis and his attorney, Fred Hettner, said that they felt that the SAO had been used by the FBI. Through FBI informant Herbert G. Goetz, who worked for the SAO, they learned that the FBI couldn't legally do themselves," Hettner told the DOOR.

This charge coincides with a DOOR investigation (see last issue) of illegal FBI and government activity in San Diego. In fact, FBI agents Peterson and Regnot visited Davis while he was in county jail awaiting sentencing. Davis told the DOOR that the FBI was investigating the activities of one Donald Simpson. Last issue, the DOOR revealed that CREEP agent Donald Segretti used the names Donald Simms and Donald Simmons and that

Segretti visited the Gunsmoke Ranch in El Cajon, a hangout for SAO members, in the summer of 1971. Davis, however, denied ever meeting anyone by the name of Donald Simms, Donald Simms, Donald Simmons or Donald Simpson.

Davis did remember plans proposed by informer Godfrey to disrupt demonstrations by leftists at the Republic Convention when it was still slated for San Diego. Davis stated that Godfrey wanted to drop some kind of incendiaries from an airplane on the demonstration sites; demonstrators.

Date:  
Edition:  
Author:  
Editor:  
Title:

Character:  
or  
Classification:  
Submitting Office:  
 Being Investigated

170-286-142

SEARCHED _____	INDEXED _____
SERIALIZED _____	FILED _____
JUL 11 1970	
FBI-SAN DIEGO	

According to Davis, Godfrey hoped to provoke a riot and possibly a counter-riot by the police. The purpose of such a riot is unclear—except that it clearly would have helped Nixon.

The DOOR investigation has learned that there was a concentrated effort by CRLEP, the FBI, and other governmental agencies to make sure that riots would disrupt the Republican FIASCO.

It appears that these plans were drawn up when it appeared that Senator Ed Muskie a serious threat, Nixon clearly would have blamed any violence on Muskie supporters. When it became apparent that McGovern had the nomination locked up and that the ITT scandal had forced the convention to move to Miami, the riot plans were clearly toned down. It is our theory that Nixon and his staff felt that they could easily beat McGovern.

Davis told us that he felt pretty much the same way and, in fact, was quick to point out the provocateur role Godfrey played. "Godfrey possessed explosives

for over 2 years," Davis said. Of course, Godfrey was never prosecuted for anything. The DOOR has learned that Godfrey is now writing a book about his experiences.

We are continuing our investigation into Watergate and the San Diego connections. If anyone has any information that might help us, give us a call. We will protect the identity of our sources.



Title and Character (170-286)

INFORMANT

SD 1155-3 (170-286)

INFORMANT

Date Property Acquired 6/30/72	Source From Which Property Acquired SD 1155-3 INFORMANT
Location of Property or Bulky Exhibit Firearms vault	Reason for Retention of Property and Efforts Made to Dispose of Same Retain temporarily until disposition
Description of Property or Exhibit and Identity of Person to Whom Same Submitted by SA EARL M. PETERSEN	

- 1 - Browning Machine Gun, Caliber 50M2, US No. 32846 Mfg by Colts Patent Firearms Mfg. Co., Hartford, Conn. (This weapon completely in a disassembled condition. Barrel has been cut off by welding torch. Not in working condition)
- 1 .38 caliber silencer no brand name but with Pat. Pending and number 96 stamped on it. Blued steel.
- 1 - Sawed off shotgun barrel and stock (also sawed off) from Sears Roebuck model 100.100 shotgun. No serial number. Barrel 13 1/2 inches long.
- 2 Rifle grenade launchers. No identifying marks.

SEMIANNUAL INVENTORY CERTIFICATION TO JUSTIFY RETENTION OF PROPERTY (Initial and Date)

OCT 13 1972  
MAR 27 1973

140

Field File # 170-286

SEARCHED INDEXED  
SERIALIZED FILED

UNITED STATES GOVERNMENT

# Memorandum

TO : SAC (170-286)(P)

FROM : SA Emil M Petersen

SUBJECT: Howard Barry Godfrey  
EM-SAO

DATE: 2/24/73

This source has been discontinued in view of his testimony in SAO cases.

Case is being kept open for disposal of bulky exhibit after Forest trial due to start March 26, 1973.

Lead:

will dispose of bulky exhibit after Forest trial,

EM 8-8  
(1)

170-286-137

SEARCHED	INDEXED
SERIALIZED	FILED
FEB 2 1973	
FBI - SAN DIEGO	

*[Handwritten signature]*



Buy U.S. Savings Bonds Regularly on the Payroll Savings Plan

UNITED STATES GOVERNMENT

# Memorandum

TO : SAC (170-286)(P)

DATE: 12/26/72

FROM : SA EARL M. PETERSEN

SUBJECT: HOWARD BARRY GODFREY  
FORMER EI

This case is being kept in a pending status until disposal of bulky exhibit in firearms vault and until end of case involving JERRY LYNN DAVIS, 157-3001, whose trial starts 1/15/72.

Some of the items in the vault will be forwarded to the Bureau and others will be returned to GODFREY.

GODFREY has been advised that inasmuch as no information was received from Bureau or Los Angeles regarding proposed individual to help him write a book that all was favorable or negative regarding him and that he could go ahead with his contact with him.

GODFREY will be in San Diego during the trial of DAVIS.

EMP:emp  
(2)



POST P

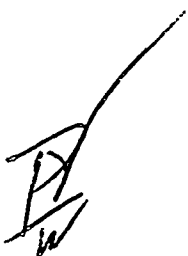

170-286-134

SEARCHED	INDEXED
SERIALIZED	FILED
DEC 26 1972	
FBI - SAN DIEGO	

167



Buy U.S. Savings Bonds Regularly on the Payroll Savings Plan

CITY San Diego, California

DATE November 6, 1972

San Diego

Request of Special Agent in Charge, FBI, \_\_\_\_\_

One Hundred dollars, and No cents,

(\$ 100.00), which money is to be paid by me on 11/9/72

to HOWARD BARRY GODFREY

for information concerning the case entitled SECRET ARMY ORGANIZATION; WILLIAM FRANCIS YAKOPEC; CALVIN FOX; GEORGE MITCHELL HOOVER.

Services: \$ 100.00 Federal Income Tax Withheld \$ \_\_\_\_\_

Expenses \$ \_\_\_\_\_

Signed: Earl M. Petersen  
Special Agent

Have payments been made by other Offices?  No  Yes (List Offices below.)

Authority (date) Bulet 7-3-72

Period Covered by Payment 9/1/72 - 11/6/72

Authorization Checked mt

Check Number 18898

Receipts Received 11-14-72

Voucher Prepared 11-20-72 Item 26

Date of Actual Payment 11/9/72

By whom SA EARL M. PETERSEN

Informant's File No. 170-286

Approved [Signature]  
SAC

170-286-132  
SEARCHED \_\_\_\_\_ INDEXED \_\_\_\_\_  
SERIALIZED \_\_\_\_\_ FILED \_\_\_\_\_  
NOV 20 1972  
FBI-SAN DIEGO

Date 6/30/72Title and ~~Serial~~ SD 1155-E (170-286)INFORMANTSD 1155-E (170-286)

Date Property Acquired <u>6/30/72</u>	Source From Which Property Acquired <u>SD 1155-E Informant</u>
Location of Property or Bulky Exhibit <u>Firearms vault</u>	Reason for Retention of Property and Efforts Made to Dispose of Same <u>Retain temporarily until disposition decided upon</u>
Description of Property or Exhibit and Identity of Person Submitting Same	

Submitted by SA EARL M. PETERSEN

- 1 - Browning Machine Gun, Caliber 50M2, US No. 32846 Mfg by Colts Patent Firearms Mfg. Co., Hartford, Conn.  
(This weapon completely in a disassembled condition. Barrel has been cut off by welding torch. Not in working condition)
- 1 .38 caliber silencer no brand name but with Pat. Pending and number 96 stamped on it. Blued steel.
- 1 - Sawed off shotgun barrel and stock (also sawed off) from Sears Roebuck model ~~100L~~ 100L100 shotgun. No serial number. Barrel 13 1/4 inches long.
- 2 Rifle grenade launchers. No identifying marks.

SEMIANNUAL INVENTORY CERTIFICATION TO JUSTIFY RETENTION OF PROPERTY (Initial and Date)

OCT 13 1972 KField File # 170-286 131SEARCHED \_\_\_\_\_ INDEXED \_\_\_\_\_  
SERIALIZED J FILED J

UNITED STATES GOVERNMENT

# Memorandum

TO : SAC (170-286)

DATE: 11/15/72

FROM : SA Earl in return

- TE
- CI
- SI
- E
- PC
- PCI
- PSI
- E (Prob)
- E (Ghetto)

SUBJECT: Howard Barry Godfrey

Dates of Contact: 11/14, 15/72

File #s on which contacted (Use Titles if File #s not available or when CI provides positive information)

*No negative contacts made*

Purpose and results of contact

NEGATIVE  
 POSITIVE  
 STATISTIC

*See memo to files,*

*tiebler ref to Council Book 11/16/72*

170-286-130

Has informant shown any indication of emotional instability, unreliability or furnishing false information?

*No*

Informant certified that he has furnished all information obtained by him since last contact.

Coverage

*Right wing*

SEARCHED  
SERIALIZED  
NOV 15 1972  
FBI - SAN DIEGO  
*LA*

PERSONAL DATA

*Emb: g  
(1)*

UNITED STATES GOVERNMENT

# Memorandum

TO : SAC (170-286)

DATE: 10/31/72

FROM : SA Earl M. Petersen

- TE
- CI
- SI
- E
- PC
- PCI
- PSI
- E (Prob)
- E (Ghetto)

SUBJECT: Howard Barry Godfrey

Dates of Contact: 9/8/72, 9/12/72, 9/15/72, 9/28/72, 10/6/72, 10/11/72, 10/30/72

File #s on which contacted (Use Titles if File #s not available or when CI provides positive information)

NO NEGATIVE CONTACT MADE

Purpose and results of contact

NEGATIVE

POSITIVE

STATISTIC

See FO 302a on memo to files.

Has informant shown any indication of emotional instability, unreliability or furnishing false information? NO

Informant certified that he has furnished all information obtained by him since last contact.

Coverage: Right wing act

PERSONAL DATA

(B)

170-286-129

SEARCHED

SERIALIZED

FBI - SAN DIEGO

EM: 8  
(1)

A

UNITED STATES GOVERNMENT

# Memorandum

TO : SAC, SAN DIEGO (170-286)

DATE: 10/26/72

FROM : SA LAWRENCE F. WIRICK

SUBJECT: HOWARD BARRY GODFREY  
FORMERLY SD 1155-E / N Formant

Re San Diego teletype to Bureau and Sacramento dated 10/26/72 and captioned SAO, Extremist Matters (SD file 157-2815).

On 10/26/72, Supervisor JAMES NEVES, Sacramento, was advised that GODFREY is currently working in the Office of Governor RONALD REAGAN and that he can be reached at telephone number 916-445-9837. There is no address for GODFREY. NEVES advised he would make arrangements to interview GODFREY by contacting him through above telephone number.

On 10/26/72, RICHARD HUFFMAN, Assistant District Attorney, County of San Diego, telephone number 236-2355, advised SA ARTHUR J. HOOPER that GODFREY could be located and contacted through above telephone number.

① - San Diego

LFW:ejt

(1) *ep*

170-286-128

SEARCHED	B	B
SERIALIZED		
<i>Maloney</i>		
		A



5010-108

Buy U.S. Savings Bonds Regularly on the Payroll Savings Plan



UNITED STATES GOVERNMENT

# Memorandum

TO : SAC SAN DIEGO

DATE: 9-19-72

FROM : Inspector D.T. Sullivan

SUBJECT: SD 1155-F Informant

CI	PCI	TE	PC	GHETTO (PROB)	137 -
					134 -
SI	PSI	EI	EI (PROB)		170 - 286

The file pertaining to the above-captioned informant has been reviewed by the Inspection Staff, and the informant has been rated as:

- Excellent
- Very Good
- Good
- Fair
- Poor
- Insufficient Data to Rate

You are referred to the appropriate survey for instructions as to those informants rated "Poor." If rated "Fair," this matter should be followed closely by you for 90 days. Specific assignments should be given the informant during this period. If, at the end of 90 days, no positive improvement is shown, the file should be closed. The Bureau should be advised of the action taken as to those informants rated "Fair," i.e., were they closed out or did they become productive.

Remarks:

170-286-127

SEARCHED	INDEXED
SERIALIZED	FILED
SEP 23 1972	
FBI - SAN DIEGO	

Peterson 197

an

San Diego

CITY \_\_\_\_\_

DATE September 6, 1972

Request of Special Agent in Charge, FBI, San Diego

One Hundred and Fifty dollars, and No cents,

(\$ 150.00 ), which money is to be paid by me on 9/6/72

to HOWARD BARRY GODFREY (SD 1155-E) IN FORAIDNT

for information concerning the case entitled SECRET ARMY ORGANIZATION, NATIONAL SOCIALIST WHITE PEOPLES PARTY, MINUTEMEN, AND INDIVIDUALS IN THESE ORGANIZATIONS.

Services: \$ 150.00 Federal Income Tax Withheld \$ \_\_\_\_\_

Expenses \$ None

Signed: Earl M. Petersen  
Special Agent

Have payments been made by other Offices?  No  Yes (List Offices below.)

Authority (date) Bulet 7-3-72

Period Covered by Payment 8/1-31/72

Authorization Checked mt

Check Number 18672

Receipts Received 9-6-72

Voucher Prepared 9-14-72 Item 5

Date of Actual Payment 9/6/72

By whom SA EARL M. PETERSEN

Informant's File No. 170-286

Approved [Signature]  
SAC

170-286-126  
SEARCHED \_\_\_\_\_ INDEXED \_\_\_\_\_  
SERIALIZED \_\_\_\_\_ FILED \_\_\_\_\_  
SEP 11 1972  
FBI - SAN DIEGO

SAC (174-531)(170-286)

8/28/72

SA EARL M. PETERSEN

WILLIAM FRANCIS YAKOPEC  
BOMBING OF GUILD MOVIE THEATRE  
EID

Re my memo to file 7/12/72.

On this date Sgt. WILLIAM BIRCH, 70th Ord. Detachment, Fort Rosecrans, California was advised that the remaining items stored with the 70 th Ord. Det. on July 6, 1972, can be destroyed.

The following items are involved:

- 1 M201A1 CS Grenade
- 5 Practise mine fuzes
- 1 Hand grenade fuze.

It is noted that the following items were turned over to Detective Rubien Brandon on about 7/12/72 by the 70th Ord. Det.:

- 100 feet commercial time fuze
- 4 ½pound blocks TNT
- 44 M1 fuze igniters

EMP:emp  
(2)

*g*

*Mr Blackburn 43  
destroy trailer*

170-286-125

SEARCHED	INDEXED
SERIALIZED	FILED
AUG 28 1972	
FBI - SAN DIEGO	

# Wife Of SAO Suspect Also Cited By Court

An investigation of activities allegedly linked to a Secret Army Organization group here has resulted in a charge against the wife of a key defendant.

She is Deborah Yakopec, 26, who pleaded innocent yesterday to possession of explosives when arraigned before Municipal Court Judge Earl B. Gilliam.

Mrs. Yakopec is the wife of William Francis Yakopec, 30, of 722 Graves Ave., El Cajon, who was indicted by the county grand jury several weeks ago on charges of attempted murder, assault with a deadly weapon on a police officer and possession of explosives. He was arrested June 26 and is being held in lieu of \$50,000 bail.

Gilliam yesterday set 1:15 p.m. Sept. 5 as the time for a preliminary hearing for Mrs. Yakopec. A hearing also is

scheduled at that time for her husband on an additional charge of possession of explosives. He pleaded innocent to the count Monday.

The new charge against Yakopec and the charge against his wife stem from another search of their home by San Diego police, according to Fred Hetter, the couple's attorney. The search was made Aug. 9, he said.

Deputy Dist. Atty. Richard Neely said an incendiary parachute illumination grenade and a detonator device were confiscated in the search.

Hetter said he plans to file charges of false arrest in both cases. He said no one was at the Yakopec home at the time of the Aug. 9 search. He said Yakopec has been held in county jail since June 27 and his wife left their home with her two children two days later. He said she has been staying in

(Continued on B-4, Col. 3)

# SAO Bombing Suspect's Wife Cited By Court

(Continued)

Santa Ana because of harassment.

When asked about the harassment, Hetter said "van-type" vehicles had been cruising slowly around the Yakopec home.

Gilliam released Mrs. Yakopec in her own recognizance yesterday.

The charges against her husband stem from the June 19 bombing of the Guild Theater, 3827 Fifth Ave., an adult movie house. No one was injured.

Mrs. Yakopec was the ninth person charged in connection with the investigation of the SAO, which has been described as an extremist paramilitary organization. A key figure in the case is Howard Berry Godfrey, a San Diego fireman who has been identified as an FBI informant in the investigation.

In a new development yesterday, Hetter said he would make a motion in Superior Court Friday "for a psychiatric examination of a complaining witness and informant (Godfrey) . . ."

Hetter said his client, Yakopec, is charged in connection with the Guild Theater bombing.

He said Godfrey is "the only witness before the grand jury who linked the defendant with the bombing."

SAN DIEGO UNIV  
8/23/72

1-157-NEW (DEBORAH YAKOPEC)  
 ①-170-286 (GODFREY)  
 1-170- (William YAKOPEC)  
 1-170-2815 (SAO)

EM 8

170-286-124

SEARCHED	INDEXED
SERIALIZED	FILED
AUG 24 1972	
FBI-SAN DIEGO	
W-	

UNITED STATES GOVERNMENT

# Memorandum

TO : SAC (170-286)(8)

DATE: 8/28/72

FROM : SA Emil in Betuman

- TE
- CI
- SI
- E ~~\_\_\_\_\_~~
- PC
- PCI
- PSI
- E (Prob)
- E (Ghetto)

SUBJECT: Howard Barry Goldfry  
Former ED 1153-E Informant

Dates of Contact  
8/23/72 - 8/28/72

File #s on which contacted (Use Titles if File #s not available or when CI provides positive information)

157-2815 (SAO)

Purpose and results of contact

NEGATIVE

POSITIVE      *Info channeled*

STATISTIC

170-286-123

Has informant shown any indication of emotional instability, unreliability or furnishing false information?  
*NO*

Informant certified that he has furnished all information obtained by him since last contact.

Coverage  
*Right wing*

PERSONAL DATA

SEARCHED \_\_\_\_\_ INDEXED \_\_\_\_\_

SERIALIZED 5 FILED B

AUG 28 1972

FBI - SAN DIEGO

*a*

EMB: Y

*(Signature)*  
*a*

CITY San Diego

DATE August 1, 1972

Assistant  
Request of Special Agent in Charge, FBI, San Diego

~~Three~~ hundred Fifty dollars, and No cents,

(~~350.00~~), which money is to be paid by me on 8/3/72

to SD 1155-E informant

for information concerning the case entitled ~~SECRET ARMY ORGANIZATION~~ and

~~NATIONAL SOCIALIST WHITE PEOPLES PARTY~~ and individual members.

Services: \$ 250.00 Federal Income Tax Withheld \$ \_\_\_\_\_

Expenses \$ 100.00  
Total \$ 350.00

Signed: Earl M. Petersen  
Special Agent

Authority (date) Bulet 7-3-72

Period Covered by Payment July 1 - 31/72

Authorization Checked ymt

Check Number 18552

Receipts Received 8-2-72

Voucher Prepared 8-7-72 Item 24

Date of Actual Payment 8/3/72

By whom SA EARL M. PETERSEN 170-286-119

Informant's File No. 170-286

Approved [Signature] SAC

SEARCHED \_\_\_\_\_ INDEXED \_\_\_\_\_  
SERIALIZED \_\_\_\_\_ FILED \_\_\_\_\_  
AUG 1 1972  
FBI-SAN DIEGO

UNITED STATES GOVERNMENT

# Memorandum

TO : SAC (170-286)

DATE: 7/31/72

FROM : SA EARL M. PETERSEN

- TE
- CI
- SI
- E
- PC
- PCI
- PSI
- E (Prob)
- E (Ghetto)

SUBJECT: SD 1155-Elmfont

Dates of Contact

*DAILY Most Recent 7/31/72*

File #s on which contacted (Use Titles if File #s not available or when CI provides positive information)

Purpose and results of contact

- NEGATIVE
- POSITIVE
- STATISTIC

*Channelized*

Has informant shown any indication of emotional instability, unreliability or furnishing false information?

*NO*

*170-286-118*

Informant certified that he has furnished all information obtained by him since last contact.

Coverage

*Right wing.*

PERSONAL DATA

*(Signature)*

SEARCHED \_\_\_\_\_ INDEXED \_\_\_\_\_  
SERIALIZED \_\_\_\_\_ FILED \_\_\_\_\_  
JUL 31 1972  
FBI - SAN DIEGO  
*IV*

*EMP: 8  
(1)*

SAC (174-531)

7/12/72

SA EARL M. PETERSEN

WILLIAM FRANCIS YAKOPEC,  
BOMBING OF GUILD MOVIE THEATRE  
EID

Attached for the file is a xerox copy of receipt for items stored with the 70th Ord. Detachment, Fort Rosecrans, California. These items received from SD 1155-E, on 6/30/72.

Original of receipt placed in 174-531, <sup>in</sup> 1A.

Source has advised that these items can be destroyed. Detective Ruben Brandon, SDPD has indicated that the blocks of TNT may be of interest as they are military explosives and came from JERRY LYNN DAVIS. Information re receipt of this information and items subject of separate communication.

Destruction of explosive items will be handled in sources file 170-286.

① - 170-286  
EMP:emp  
(2)

*Detective Ruben Brandon advised today that he needs 4 1/2 lb blocks of TNT. He will get them in police. Time fuse + dynamite.*  
Brandon  
Earl

Mrs Blackburn set tickler for 7/24/72 for advising 70th Ordnance that explosives can be destroyed unless needed by SDPD.

*Mrs Blackburn* *Earl*

170-286-115

SEARCHED	INDEXED
SERIALIZED	FILED
JUL 13 1972	
FBI - SAN DIEGO	





DEPARTMENT OF THE ARMY  
70TH ORDNANCE DETACHMENT (EOD)  
FORT ROSECRANS, SAN DIEGO, CALIFORNIA 92106

6 July 1972

The 70th Ord Det (EOD) received the below listed items from Agent Petersen, FBI, to be held for a period of app. two weeks, or to destroy these items later.

- 1 ea. M201A1 CS Grenade
- 100 ft. Comm. time fuze
- 4 ea. 1/2 lb. blocks TNT
- 5 ea. mine fuze, practice
- 1 ea. hand grenade fuze
- 44 ea. M1 fuze igniters

To Detachment Bureau  
SDPD 7/12/72  
g

*James O. Barnett*  
JAMES O. BARNETT  
2LT OrdC  
Commanding

*Earl M. Petersen*

Agent Petersen  
FBI

Original in 174-~~351~~<sup>531</sup> 1A

Sgt. [unclear] [unclear]  
to 70th Ord Det  
destroyed remaining  
items 7/25/72  
g

CITY San Diego, California

DATE July 10, 1972

Request of Special Agent in Charge, FBI, San Diego

Two hundred dollars, and No cents,

(\$ 200.00 ), which money is to be paid by me on 7/10/72

to SD 1155-E *enjoyment*

for information concerning the case entitled WILLIAM FRANCES YAKOPEK, BOMBING OF GUILD MOVIE THEATER, THREE EIGHT TWO SEVEN - 5th AVENUE, SAN DIEGO, JUNE 19, 1972. EID.

Services: \$ None Federal Income Tax Withheld \$ \_\_\_\_\_

Expenses \$ \$200.00

Signed: *Earl M. Petersen*  
Special Agent

Authority (date) Bureau teletype 7/3/72

Period Covered by Payment --

Authorization Checked *mt*

Check Number 18476

Receipts Received 7-13-72

Voucher Prepared 7-19-72 Item 2

Date of Actual Payment 7/10/72

By whom SA EARL M. PETERSEN

Informant's File No. 170-286

Approved *W* *JBS*  
SAC

170-286-114  
SEARCHED \_\_\_\_\_ INDEXED \_\_\_\_\_  
SERIALIZED \_\_\_\_\_ FILED \_\_\_\_\_  
JUL 11 1972  
FBI-SAN DIEGO

CITY San Diego, California

DATE June 14, 1972

Request of Special Agent in Charge, FBI, San Diego

One Hundred and Fortytwo dollars, and Nineteen----- cents,

(\$ 242.19), which money is to be paid by me on 6/14/72

to SD 1155-E *informant*

for information concerning the case entitled Secret Army Organization; JERRY LYNN DAVIS; JAMES EVAN POTO; DONALD WILLIAM CARRIE; CALVIN HENDELL FOX.

Expenses incurred in use of personal automobile, postage, purchase of miscellaneous items, etc.

Services: \$ 213.00

Federal Income Tax Withheld \$ \_\_\_\_\_

Expenses \$ 27.19

Signed: *Steven L. Christensen*  
Special Agent

Have payments been made by other Offices?  No  Yes (List Offices below.)

Authority (date) Bulet 1/4/72

Period Covered by Payment 5/1 - 31/72

Authorization Checked WNT

Check Number 13392

Receipts Received 6-21-72

Voucher Prepared 6-23-72 Item 2

Date of Actual Payment 6/14/72

By whom SA STEVEN L. CHRISTENSEN

Informant's File No. 170-286

Approved *W* *ES*  
SAC

170-286-113  
SEARCHED \_\_\_\_\_ INDEXED \_\_\_\_\_  
SERIALIZED \_\_\_\_\_ FILED \_\_\_\_\_  
JUN 1972  
FBI - SAN DIEGO  
11/8

CITY San Diego, California

DATE July 10, 1972

Request of Special Agent in Charge, FBI, San Diego

Three hundred and fifty dollars, and no cents,

(\$ 350.00 ), which money is to be paid by me on July 10, 1972

to SD 1155-E informant

for information concerning the case entitled Secret Army Organization, JERRY LYNN

DAVIS, CALVIN HENDELL FOX, WILLIAM FRANCIS YAKOPEC, GEORGE HOOVER, RICHARD FLEURY, GENEVIEVE FLEURY.

Services: \$ 250.00

Federal Income Tax Withheld \$ \_\_\_\_\_

Expenses \$ 100.00\*

Total \$ 350.00

\*Actual expense was \$101.05

Signed: Earl M. Petersen  
Special Agent

Authority (date) Bulet 1/14/72 7/3/72

Period Covered by Payment 6/1-30/72

Authorization Checked mt

Check Number 12477

Receipts Received 7-11-72

Voucher Prepared 7-14-72 Item 46

Date of Actual Payment 7/10/72

By whom SA EARL M. PETERSEN

Informant's File No. 170-286

Approved [Signature]  
SAC

170-286-112  
SEARCHED \_\_\_\_\_ INDEXED \_\_\_\_\_  
SERIALIZED \_\_\_\_\_ FILED \_\_\_\_\_  
JUL 11 1972  
FBI-SAN DIEGO

UNITED STATES GOVERNMENT

# Memorandum

TO : SAC San Diego (170-286)

FROM : SA Steven L. Christensen

SUBJECT: SD 1155 - Enfant

DATE: 5/31/72

- TE
- CI
- SI
- E
- PC
- PCI
- PSI
- E (Prob)
- E (Ghetto)

Dates of Contact  
Contact several times weekly during April + May, 1972

File #s on which contacted (Use Titles if File #s not available or when CI provides positive information)

157-2815

157-28

157-3021

157-3017

157-3170

157-3169

Purpose and results of contact

NEGATIVE

POSITIVE

STATISTIC

Info to files by "C" memo.

FORM G-1

FILE # 170-286

DATE RECEIVED 6/15/72

DATE RETURNED \_\_\_\_\_

BY \_\_\_\_\_

Has informant shown any indication of emotional instability, unreliability or furnishing false information? 1/0

170-286-100

Informant certified that he has furnished all information obtained by him since last contact.

Coverage Extremist

PERSONAL DATA

SEARCHED \_\_\_\_\_ INDEXED \_\_\_\_\_

SERIALIZED \_\_\_\_\_ FILED \_\_\_\_\_

JUN - 6 1972

FBI - SAN DIEGO

CITY San Diego, California

DATE May 11, 1972

Request of Special Agent in Charge, FBI, San Diego

~~Two Hundred and Thirtysix~~ dollars, and ~~Seventy~~ cents,

(\$ 236.70 ), which money is to be paid by me on May 11, 1972

to SD 1155 - E informant

for information concerning the case entitled Secret Army Organization; National Socialist White People's Party; JERRY LYNN DAVIS; GERALD LEE SMITH; CALREP.

~~Expenses incurred in use of personal automobile, telephone calls, postage, etc.~~

Services: \$ 220.00

Federal Income Tax Withheld \$ \_\_\_\_\_

Expenses \$ 16.70

Signed: Steven L. Christensen  
Special Agent

Have payments been made by other Offices?  No  Yes (List Offices below.)

Authority (date) Bulet 1/4/72

Period Covered by Payment Services 4/1-30/72; Expenses 4/15-30/72.

Authorization Checked ymt

Check Number 18290

Receipts Received 5-17-72

Voucher Prepared 5-25-72 Item 3

Date of Actual Payment 5/12/72

By whom SA STEVEN L. CHRISTENSEN

Informant's File No. 170-286

AM Approved \_\_\_\_\_ SAC

170-286-99  
SEARCHED \_\_\_\_\_ INDEXED \_\_\_\_\_  
SERIALIZED JS FILED 12  
MAY 3 1972  
FBI-SAN DIEGO

CITY San Diego, California

DATE April 14, 1972

Request of Special Agent in Charge, FBI, San Diego

~~Thirtysix~~ dollars, and ~~no~~ cents,

(\$ 35.00 ), which money is to be paid by me on April 14, 1972

to SD 1155-E *exhibit*

for information concerning the case entitled Secret Army Organization. Expenses  
for special assessment and postage in connection with production  
of most recent organizational bulletin.

Services: \$ 0.00

Federal Income Tax Withheld \$ 0.00

Expenses \$ 36.00

Signed: *Steven L. Christensen*  
Special Agent

Have payments been made by other Offices?  No  Yes (List Offices below.)

Authority (date) Bulet 1/11/72

Period Covered by Payment 4/1 to 4/14/72

Authorization Checked *mt*

Check Number 18201

Receipts Received 5-8-72

Voucher Prepared 5-12-72 Item 2

Date of Actual Payment 4/14/72

By whom SA STEVEN L. CHRISTENSEN

Informant's File No. 170-286

Approved *[Signature]*

170-286-98  
SEARCHED \_\_\_\_\_ INDEXED \_\_\_\_\_  
SERIALIZED 7 FILED 12  
MAY 1 1972  
FBI-SAN DIEGO

CITY San Diego, California

DATE April 4, 1972

Request of Special Agent in Charge, FBI, San Diego

~~Two Hundred and Thirtysix~~ dollars, and ~~forty~~ cents,

(\$ 236.40 ), which money is to be paid by me on April 7, 1972

to SD 1155-Exp. *for work*

for information concerning the case entitled Secret Army Organization; JERRY LYNN DAVIS; CY ANDERSON; RONALD MICHAEL ZARICK; GEORGE M. HOOVER; National Socialist White People's Party; GERALD LEE SMITH; LARAY D. WILSON. Expenses incurred in use of personal automobile, postage, telephone calls, and miscellaneous purchases.

Services: \$ 205.00

Federal Income Tax Withheld \$ None

Expenses \$ 31.40

Signed: *Steven L. Christensen*  
Special Agent

Have payments been made by other Offices?  No  Yes (List Offices below.)

Authority (date) Bulet 1/1/72

Period Covered by Payment 3/1 - 31/72

Authorization Checked *mad*

Check Number 18160

Receipts Received 4/7/72

Voucher Prepared Item 12

Date of Actual Payment 4/7/72

By whom SA STEVEN L. CHRISTENSEN

Informant's File No. 170-286

Approved *W* *S*

SAC

170-286-97

SEARCHED	INDEXED
SERIALIZED	FILED
APR 11 1972	
FBI-SAN DIEGO	



UNITED STATES GOVERNMENT

# Memorandum

TO : SAC *San Diego (100-786)*

DATE: *3/31/72*

FROM : SA *Steven L. Christensen*

- TE
- CI
- SI
- E
- PC
- PCI
- PSI
- E (Prob)
- E (Ghetto)

SUBJECT: *Informant*  
*SO 1055-E*

Dates of Contact  
*Contact several times weekly during February + March, 1972*

File #s on which contacted (Use Titles if File #s not available or when CI provides positive information)

*157-2815*

*157-28*

*157-3007*

*157-3017*

*157-201 + others*

Purpose and results of contact

NEGATIVE

POSITIVE

STATISTIC

*Info in "C" memos*

Has informant shown any indication of potential instability, unreliability or furnishing false information? *No*

Informant certified that he has furnished all information obtained by him since last contact.

Coverage *Extremist*

PERSONAL DATA

*[Handwritten initials]*

SEARCHED INDEXED  
SERIALIZED FILED  
APR 1972  
FBI - SAN DIEGO

CITY San Diego, California

DATE March 6, 1972

Request of Special Agent in Charge, FBI, San Diego

Two Hundred and five dollars, and no----- cents,

(\$ 205.00 ), which money is to be paid by me on March 6<sup>14</sup>, 1972

to *Informant*  
SD 1155-E

for information concerning the case entitled Secret Army Organization; National Socialist White Peoples Party; JERRY LYNN DAVIS; GEORGE HOOVER; FRANK UACOPEC; ROBERT MAYER.

Services: \$ 205.00

Federal Income Tax Withheld \$ \_\_\_\_\_

Expenses \$ \_\_\_\_\_

Signed

*Steven L. Christensen*  
Special Agent

Have payments been made by other Offices?  No  Yes (List Offices below.)

Authority (date) Bulet 1/4/72

Period Covered by Payment 2/1 to 29/72

Authorization Checked *oak*

Check Number *18055*

Receipts Received *3/14/72*

Voucher Prepared *3/7/72* Item 11

Date of Actual Payment *3/8/72*

By whom SA STEVEN L. CHRISTENSEN

Informant's File No. 170-286

Approved *[Signature]*

SAC

170-286-95  
SEARCHED \_\_\_\_\_ INDEXED \_\_\_\_\_  
SERIALIZED *[initials]* FILED *[initials]*  
MAR 17 1972  
FBI - SAN DIEGO

CITY San Diego, California

DATE February, 16, 1972

Request of Special Agent in Charge, FBI, San Diego

Fifty----- dollars, and no----- cents,

(\$ 50.00 ), which money is to be paid by me on February 18, 1972

to SD 1155-E

for information concerning the case entitled JERRY LYNN DAVIS; Secret Army Organization. Money expended in transportation and purchases incurred in providing coverage of these cases.

Services: \$ ----- Federal Income Tax Withheld \$ -----

Expenses \$ 50.00

Signed: Steven L. Christensen  
Special Agent

Have payments been made by other Offices?  No  Yes (List Offices below.)

Authority (date) Bulet. 1/11/72

Period Covered by Payment 2/1/72 - 2/15/72

Authorization Checked mal

Check Number 17991

Cheques Received 2/18/72

Check Prepared 2/28/72 Item 9

Date of Actual Payment 2/18/72

By whom SA STEVEN L. CHRISTENSEN

Grantor's File No. 170-286

Approved [Signature]  
SAC

170-286-94  
SEARCHED \_\_\_\_\_ INDEXED \_\_\_\_\_  
SERIALIZED [initials] FILED [initials]  
FEB 28 1972  
FBI - SAN DIEGO

CITY San Diego, California

DATE January 28, 1972

Assistant Request of Special Agent in Charge, FBI, San Diego

Two Hundred and Fortytwo dollars, and Forty-- cents,

(\$ 242.40 ), which money is to be paid by me on 2/1/72 ~~January 31, 1972~~

to SD 1155-~~E~~ *[Handwritten]*

for information concerning the case entitled Secret Army Organization; National Socialist White Peoples Party; The Ocean Beach Collective; JERRY LYNN DAVIS; RON ZARICK; ROBERT S. MAYER.

Expenses were incurred in use of personal automobile, postage, telephone calls and other miscellaneous purchases.

Services: \$ 220.00 Federal Income Tax Withheld \$ \_\_\_\_\_

Expenses \$ 22.40

Signed: *[Signature]*  
Special Agent

Have payments been made by other Offices?  No  Yes (List Offices below.)

Authority (date) Bulet to S.D. 1/4/72

Period Covered by Payment 1/1 - 31/72

Authorization Checked *[Handwritten]*

Check Number 17921

Receipts Received 2/1/72

Voucher Prepared 2/4/72 Item 12

Date of Actual Payment ~~2/2/72~~ 2/1/72

By whom SA STEVEN L. CHRISTENSEN

Informant's File No. 170-286

Approved \_\_\_\_\_

170-286-93  
INDEXED FILED  
FEB 1 1972  
FBI - SAN DIEGO

UNITED STATES GOVERNMENT

# Memorandum

TO : SAC, *San Diego (170-286)* DATE: *1/31/72*

FROM : SA *Steven L. Christensen*

- TE
- CI
- SI
- E
- PC
- PCI
- PSI
- E (Prob)
- E (Ghetto)

SUBJECT: *SD 1158-E informant*

**Dates of Contact**  
*Several times weekly during November, December*

**File #s on which contacted (Use Titles if File #s not available or when CI provides positive information)**

*157-1798*

*157-28*

*100-14297*

*100-14273*

**Purpose and results of contact**

NEGATIVE

POSITIVE

STATISTIC

*Info disseminated by "C" memo.*

Has informant shown any indication of emotional instability, unreliability or furnishing false information? *No*

Informant certified that he has furnished all information obtained by him since last contact.

Coverage  
*Relevant Matters*

PERSONAL DATA

*SEARCHED INDEXED SERIALIZED FILED*

*JAN 31 1972*

*FBI - SAN DIEGO*

*W*

CITY San Diego, California

DATE January 10, 1972

Request of Special Agent in Charge, FBI, San Diego

~~Two Hundred and Fiftythree~~ dollars, and Seventyfive cents,

(\$ 253.75 ), which money is to be paid by me on January 10<sup>3</sup>, 1972

to SD 1155-E informant

for information concerning the case entitled Minuteman Organization; Secret Army Organization; National Socialist White People's Party; White Power Information Center; JERRY LYNN DAVIS; STANLEY DON MCDADE; GEORGE HOOVER; JAMES EVAN POTO; B ETTIE HAUGHTON.

Services: \$ 215.00

Federal Income Tax Withheld \$ \_\_\_\_\_

Expenses \$ 38.75

Signed: Steven L. Christensen  
Special Agent

Authority (date) 1/11/72 Bulet \_\_\_\_\_

Period Covered by Payment 12/1 - 31/71

Authorization Checked [Signature]

Check Number 17860

Receipts Received 1/13/72

Voucher Prepared 1/17/72 Item 8

Date of Actual Payment 1/18/72

By whom SA STEVEN L. CHRISTENSEN

Informant's File No. 170-286

*1/10/72*

170-286-91  
SEARCHED  
SERIALIZED  
INDEXED  
FILED  
JAN 13 1972  
FBI - SAN DIEGO

Approved [Signature] SAC

UNITED STATES GOVERNMENT

# Memorandum

TO : SAC, SAN DIEGO (170-286)

DATE: 1/13/72

FROM : SA STEVEN L. CHRISTENSEN

SUBJECT: SD 1155-Enj  
EM - MM

On 1/12/72 Informant was contacted by writer at which time he furnished the following information.

Recently the Secret Army Organization prepared and distributed a special bulletin regarding PETER GEORGE BOHMER. Response from Right Wing sympathizers to this bulletin has been very encouraging and consequently, on 1/6/72, source was given an assignment by JERRY LYNN DAVIS, leader of the SAO, to conduct a surveillance of the residence of BOHMER at 5155 Muir, Ocean Beach, for the purpose of obtaining additional intelligence information, such as license plate numbers and descriptions of occupants. ~~\_\_\_\_\_~~  
This information was to be used in the preparation of a future intelligence bulletin of the SAO.

In order to avoid going on this assignment alone, source contacted GEORGE M. HOOVER, an associate of members of the SAO, and requested that he accompany source. Source and HOOVER arrived in the vicinity of BOHMER's residence at about 8:45 PM that evening, watched the house for a period of time, ~~\_\_\_\_\_~~

went so far as to place ~~\_\_\_\_\_~~ an SAO sticker on the front door of the house. Informant advised that at no time did he see anyone enter ~~\_\_\_\_\_~~ the house, and both he and HOOVER assumed the house to have been unoccupied ~~\_\_\_\_\_~~ afterwards.

Source advised that prior to going home he drove by the house one last time. He said that HOOVER, who always has one or more pistols with him at all times, made a statement about the house, exact nature unrecalled, pointed a pistol out the passenger window of the car, and fired two shots at the house. Source advised that fortunately the pistol, an automatic, jammed on the third shot or he feels certain HOOVER would have emptied the clip in the gun. Source said he then yelled at HOOVER "What do you think you're doing?", and then ~~\_\_\_\_\_~~ the area as quickly as possible.

*determined there were no cars which could be associated with the house, and I did see two persons leave*

1 - SD 170-286  
SLC/slc  
(1)

*ALL INFORMATION CONTAINED HEREIN IS UNCLASSIFIED EXCEPT WHERE SHOWN OTHERWISE*

170-286-90

SEARCHED	INDEXED
SERIALIZED	FILED
JAN 13 1972	
FBI - SAN DIEGO	







CITY San Diego, California

DATE November 26, 1971

Request of Special Agent in Charge, FBI, San Diego

~~Two Hundred and Fortytseven~~ dollars, and ~~Fifty~~ cents,

(~~\$ 247.50~~), which money is to be paid by me on November 30, 1971

to SD 1155-E *Carhart*

for information concerning the case entitled ~~Minuteman Organization; Secret~~

~~Army Organization; JERRY LYNN DAVIS; GEORGE HOOVER; FRANK~~

~~YOCOPEC; PETER RUPLINGER.~~

~~Expenses incurred in use of personal automobile, tele phone calls, postage, and purchase of miscellaneous supplies.~~

Services: \$ 220.00

Federal Income Tax Withheld \$ \_\_\_\_\_

Expenses \$ 27.50

Signed: *Steven L. Christensen*  
Special Agent

Authority (date) Bulet 6/10/71

Period Covered by Payment 11/1 - 30/71

Authorization Checked *ceh*

Check Number 17745

Receipts Received 12/1/71

Voucher Prepared 12/7/71

Date of Actual Payment 11/30/71

By whom SA STEVEN L. CHRISTENSEN

Informant's File No. 170-286

Approved *[Signature]*  
SAC

*FORM OF - T ret for*

FILE # 170-286 *12/30/71*

DATE RECEIVED 12/21/71

INDEXED 12-21

SEARCHED BY 12-27

SEARCHED \_\_\_\_\_ INDEXED \_\_\_\_\_

SERIALIZED 2 FILED 3

DEC 23 1971

FBI - SAN DIEGO

UNITED STATES GOVERNMENT

# Memorandum

TO : SAC *San Diego (170-286)* DATE: *11/30/71*

FROM : SA *Steven L. Christensen*  TE  CI  SI  E  
 PC  PCI  PSI  E (Prob)  
 E (Ghetto)

SUBJECT: *SD 1153 - Enjoinment*

Dates of Contact  
*Social contacts weekly during October + November 1971*

File #s on which contacted (Use Titles if File #s not available or when CI provides positive information)

---

---

---

---

---

---

Purpose and results of contact

NEGATIVE  
 POSITIVE  
 STATISTIC

*Info disseminated to files by "C" memo.*

*170-286-86A*

Has informant shown any indication of emotional instability, unreliability or furnishing false information? *No*

Informant certified that he has furnished all information obtained by him since last contact. Coverage *Extremist Matters*

PERSONAL DATA

*(P)*

*A*

SEARCHED	INDEXED
SERIALIZED	FILED
FBI - SAN DIEGO	

CITY San Diego, California

DATE October 29, 1971

Recipient of Special Agent in Charge, FBI, San Diego

Two Hundred and Thirtyone dollars, and Forty--- cents,

(\$ 231.40 ), which money is to be paid by me on October 29, 1971

to SD 1155-E informant

for information concerning the case entitled: Minuteman Organization; JERRY LYNN DAVIS; Secret Army Organization; JAMES EVAN POTO; CY ANDERSON. Expenses were incurred in use of personal automobile, postage, telephone calls, and purchase of miscellaneous items.

Services: \$ 210.00

Federal Income Tax Withheld \$ \_\_\_\_\_

Expenses \$ 21.40

Signed: Steven L. Christensen  
Special Agent

Have payments been made by other Offices?  No  Yes (List Offices below.)

Authority (date) Bulet 6/1/71

Period Covered by Payment 10/1 - 29/71

Authorization Checked male

Check Number 17669

Receipts Received 11/4/71

Voucher Prepared 11/9/71 Item 18

Date of Actual Payment 10/29/71

By whom SA STEVEN L. CHRISTENSEN

Informant's File No. 170-286

170-286-86  
SEARCHED \_\_\_\_\_ INDEXED \_\_\_\_\_  
SERIALIZED 17 FILED 17  
NOV 9 1971  
FBI - SAN DIEGO

UNITED STATES GOVERNMENT

# Memorandum

TO : SAC

DATE: 10/22/71

FROM : Inspector Thomas W. Kitchens

SUBJECT: SD 1155-E *informant*

CI	PCI	TE	PC	GHETTO (PROB)
SI	PSI	<u>EI</u>	EI (PROB)	

137 -  
134 -  
170 - 286

The file pertaining to the above-captioned informant has been reviewed by the Inspection Staff, and the informant has been rated as:

- Excellent
- Very Good
- Good
- Fair
- Poor
- Insufficient Data to Rate

You are referred to the appropriate survey for instructions as to those informants rated "Poor." If rated "Fair," this matter should be followed closely by you for 90 days. Specific assignments should be given the informant during this period. If, at the end of 90 days, no positive improvement is shown, the file should be closed. The Bureau should be advised of the action taken as to those informants rated "Fair," i.e., were they closed out or did they become productive.

Remarks:

170-286-83

SEARCHED	INDEXED
SERIALIZED	FILED
OCT 27 1971	
FBI - SAN DIEGO	

*Ch...*

CITY San Diego, California

DATE September 30, 1971

Request of Special Agent in Charge, FBI, San Diego

Two Hundred and Thirty dollars, and Fiftyfive cents,

(\$ 230.55), which money is to be paid by me on September 30, 1971

to SD 1155-E

for information concerning the case entitled Minuteman Organization; WILLIAM CLAY; JERRY LYNN DAVIS; HOWARD CLARK; GERALD L. SMITH; ROGER DRAPEAU; American Nazi Party.

Services: \$ 205.00

Federal Income Tax Withheld \$ \_\_\_\_\_

Expenses \$ 25.55

Signed: Steven L. Christensen  
Special Agent

Have payments been made by other Offices?  No  Yes (List Offices below.)

Authority (date) Bulet 6/10/71

Period Covered by Payment 9/1 - 30/71

Authorization Checked C.A.H.

Check Number 17582

Receipts Received 10/4/71

Voucher Prepared 10/6/71 Item 17

Date of Actual Payment 9/30/71

By whom SA STEVEN L. CHRISTENSEN

Informant's File No. 170-286

Approved \_\_\_\_\_ SAC

170-286-84  
SEARCHED \_\_\_\_\_ INDEXED \_\_\_\_\_  
SERIALIZED \_\_\_\_\_ FILED \_\_\_\_\_  
FBI - SAN DIEGO

CITY San Diego, California

DATE September 23, 1971

Request of Special Agent in Charge, FBI, San Diego

Two Hundred and Thirtyfive dollars, and Twelve cents,

(\$ 235.12), which money is to be paid by me on September 23, 1971

to SD 1155 Informant

for information concerning the case entitled, JERRY LYNN DAVIS; Minuteman Organi-  
zation; American Nazi Party; George Hoover; James Evan Poto.

Expenses incurred in use of personal automobile, telephone calls,  
and purchase of miscellaneous supplies and other items.

Services: \$ 205.00 Federal Income Tax Withheld \$ \_\_\_\_\_

Expenses \$ 30.12

Signed: Steven L. Christensen  
Special Agent

Have payments been made by other Offices?  No  Yes (List Offices below.)

Authority (date) Bulet 6/10/71

Period Covered by Payment 8/1 - 31/71

Authorization Checked cab

Check Number 17550

Receipts Received 10/4/71

Voucher Prepared 10/6/71 Item 8

Date of Actual Payment 9/23/71

By whom SA STEVEN L. CHRISTENSEN

Informant's File No. 170-286

170-286-83  
SEARCHED \_\_\_\_\_ INDEXED \_\_\_\_\_  
SERIALIZED FB  
FBI - SAN DIEGO

Approved [Signature]  
SAC

UNITED STATES GOVERNMENT

# Memorandum

TO : SA S. CHRISTENSEN (170-238)

DATE: 10/5/71

FROM : *E/* SUPERVISOR ANTHONY J. MALONEY, JR.

SUBJECT: *inf. out*  
SD 1155-E

A review of captioned informant's file reflects that the items called for in the FD-377 (Extremist Informant Review Sheet) have not been completed.

You are requested to complete the FD-377 as soon as possible.

1 - San Diego

AJM :mt  
(1)

170-286-82  
SEARCHED INDEXED  
SERIALIZED FILED  
OCT 10 1971  
FBI - SAN DIEGO  
*[Signature]*



UNITED STATES GOVERNMENT

# Memorandum

TO : SAC San Diego (170-286)

DATE: 9/30/71

FROM : SA Steven L. Christensen

- TE
- CI
- SI
- R
- PC
- PCI
- PSI
- R (Prob)
- 

SUBJECT: <sup>informant</sup>  
SD 1155-E

Dates of Contact  
*Several times weekly during 8/1 - 9/30/71*

File #s on which contacted (Use Titles if File #s not available or when CI provides positive information)

157-1798

157-1817

157-2558

100-14297

174-428

Purpose and results of contact

NEGATIVE

POSITIVE

STATISTIC

*Info disseminated to files by memo.*

Has informant shown any indication of emotional instability, unreliability or furnishing false information? No

Informant certified that he has furnished all information obtained by him since last contact.

Coverage  
*Racial, new left*

PERSONAL DATA

170-286-81

SEARCHED

SERIALIZED

OCT 1 1971

FBI - SAN DIEGO



UNITED STATES GOVERNMENT

# Memorandum

TO : ALL AGENTS

DATE: 9/24/71

FROM: SAC ROBERT W. EVANS (170-411)

SUBJECT: EXTREMIST INFORMANTS  
EXTREMIST MATTERS

A recent article appearing in the Black Panther Party (BPP) Cleaver Faction publication "Right On!" calls for swift and unmerciful retaliation against current and former extremist informants. This article contains numerous inflammatory statements and may well signal the initiation of widespread retaliation against our informants.

Recently seized items from the Republic of New Africa (RNA) included instructions to RNA members concerning the indoctrination of those members suspected of being law enforcement informants. These instructions basically involve the completion of a personal questionnaire form and background investigation.

Each agent should recognize the continuing possibility of infiltrators within our extremist informant ranks. There have been attempts in the past to penetrate informant ranks, and we can logically expect there will be attempts in the future in this regard. Therefore, all agents are reminded of the importance of in-depth background investigation and personal knowledge of each informant, as well as the necessity for careful verification and evaluation of information furnished by extremist informants.

Each agent handling an extremist informant, including extremist ghetto informants, should be thoroughly alert to the absolute necessity for handling these informants under the most secure conditions in order to eliminate the possibility of these informants being exposed. All agents should also bring to the attention of their informants the Republic of New Africa's methods of disclosing infiltrators in order that our informants will be forewarned.

- 1 - 170-411
- 1 - 170-00
- ② - Each 170 File
- 1 - 66-61

AJM:mt  
(262)

170-256-80

SEARCHED	INDEXED
SERIALIZED	FILED

SEP 28 1971  
FBI - SAN DIEGO

*[Handwritten signature]*



SD 170-411

You should indicate in longhand on this memo which will be made part of your informant's file, the date upon which you advised your informant to be alert for the possibility of efforts by leaders of extremist organizations to ferret out infiltrators.

*Advised on 9/29/71*

TO: SAC, SAN DIEGO (170-286)

9/23/71

FROM: SA STEVEN L. CHRISTENSEN

SUBJECT: SD 1155-E informant

Rebulet dated 8/20/71 captioned, "Confidential Fund And Informant Report".

Pursuant to instructions set forth in rebulet a tabulation of payments made to above captioned from Feb. 1, 1971 to July 31, 1971 was made as follows:

SERVICES

Total Amount paid from Feb.1 through July 31, 1971.	-----\$	<u>1400.00</u>
Average monthly payment made.	-----\$	<u>233.33</u>
5% of \$ <u>233.33</u>		equals \$ <u>11.66</u>

Maximum payment that may be made to this Source per month hereafter.-----\$ 221.67

EXPENSES

Total Amount paid from Feb. 1 through July 31, 1971.	-----\$	<u>303.50</u>
Average monthly payment.	-----\$	<u>50.50</u>
5% of \$ <u>50.50</u>		equals \$ <u>2.53</u>

Maximum monthly payments allowed for expenses hereafter--\$ 47.97

ASD/

① - SD 170-286  
 1 - SD 66-476  
 SLC/slc  
 (2)

*Winks*

170-286-7

SEARCHED	INDEXED
SERIALIZED	FILED
SEP 23 1971	
FBI - SAN DIEGO	

RPR/ccc

UNITED STATES ATTORNEY

SOUTHERN DISTRICT OF CALIFORNIA  
UNITED STATES COURTHOUSE  
325 WEST F STREET  
SAN DIEGO 92101

July 28, 1971

Mr. Robert W. Evans  
Special Agent in Charge  
Federal Bureau of Investigation  
3211 Fifth Avenue  
San Diego, California 92103

Dear Mr. Evans:

Thank you for your letter of July 26, 1971.

I advised all parties to our conference on July 23, 1971, that the Attorney General has been given statutory authority by Congress to provide witness protection facilities if necessary. The Attorney General's statutory authority in this matter is the Organized Crime Control Act of 1970. However, before any implementation of this act takes place, the United States Attorney's Office must consult with the Criminal Division of the Department of Justice.

Should it become necessary that your informant testifies in the ATFD case, the matter of this informant's safety will be brought to the attention of the Department of Justice.

If you have any further questions, please do not hesitate to contact me.

Very truly yours,

HARRY D. STEWARD  
United States Attorney



ROBERT P. RISSO  
Assistant U. S. Attorney

170-286-78

SEARCHED	INDEXED
SERIALIZED	FILED
JUL 29 1971	
FBI - SAN DIEGO	

*Christina*

*File  
ref in 174-428*

CITY San Diego, California

DATE July 30, 1971

Request of Special Agent in Charge, FBI, San Diego

Three hundred and fortysix dollars, and no----- cents,

(\$ 346.00), which money is to be paid by me on July 30, 1971

to SD 1155 - R *Informant*

for information concerning the case entitled Minuteman Organization; JERRY LYNN DAVIS, aka Sam Davis; EUGENE BROWN, Bombing Matter; JAMES EVAN POTO; PETER RUPLINGER; American Nazi Party; National Socialist White Poeples Party. Expenses were incurred in the use of personal automobile, telephone calls and miscellaneous purchases.

Services: \$ 250.00 Federal Income Tax Withheld \$ \_\_\_\_\_

Expenses \$ 96.00

Signed: *Steven L. Christensen*  
Special Agent

Authority (date) *Beckitt* 6/10/71

Period Covered by Payment 7/1 - 30/71

Authorization Checked *[Signature]*

Check Number 17394

Receipts Received 8/2/71

Voucher Prepared 8/4/71 Item 8

Date of Actual Payment 7/30/71

By whom SA STEVEN L. CHRISTENSEN

Informant's File No. 170-286

*On* Approved *[Signature]* SAC

170-286-77  
SEARCHED \_\_\_\_\_ INDEXED \_\_\_\_\_  
SERIALIZED JR FILED R  
JUL 31 1971  
FBI - SAN DIEGO

CITY San Diego, California

DATE July 23, 1971

Request of Special Agent in Charge, FBI, San Diego

Two Hundred and Ninetyone dollars, and Twentyfive cents,

(\$ 291.25, which money is to be paid by me on July 23, 1971

to informant SD 1155 - R

for information concerning the case entitled Minuteman Organization; TROY

HAUGHTON; JERRY LYNN DAVIS; MARY TOLLERTON; ROBERT DE PUGH;

PETER RUPLINGER. Expenses incurred in use of telephone, personal automobile and miscellaneous purchases.

Services: \$ 240.00 Federal Income Tax Withheld \$ \_\_\_\_\_

Expenses \$ 51.25

Signed: Steven L. Christensen  
Special Agent

Authority (date) Bulet 6/10/71

Period Covered by Payment 6/1 - 30/71

Authorization Checked cek

Check Number 17766

Receipts Received 7/27/71

Voucher Prepared 7/30/71 Item 8

Date of Actual Payment 7/23/71

By whom SA STEVEN L. CHRISTENSEN

Informant's File No. 170-286

Am Approved \_\_\_\_\_ SAC

170-286-  
SEARCHED \_\_\_\_\_  
SERIALIZED B J

UNITED STATES GOVERNMENT

# Memorandum

TO : SAC San Diego (170-286) DATE: 7/31/71

FROM : SA Steven L. Christensen

- TE
- CI
- SI
- R
- PC
- PCI
- PSI
- R (Prob)

SUBJECT: <sup>informant</sup>  
SD 1055-R

Dates of Contact: Several contacts weekly during period 6/1-7/31/71

File #s on which contacted (Use Titles if File #s not available or when CI provides positive information)

<u>157-1748</u>	<u>Menuteau</u>
<u>100-14297</u>	<u>Jerry Meyer Dan's</u>
<u>157-2609</u>	<u>Nazi Weapons.</u>
<u>157-28</u>	<u>Nazi Party</u>

Purpose and results of contact

NEGATIVE  
 POSITIVE  
 STATISTIC

"C" memos prepared

Has informant shown any indication of emotional instability, unreliability or furnishing false information? No 170-286-71

Informant certified that he has furnished all information obtained by him since last contact.

Coverage  
Racial; New Left

PERSONAL DATA

Christensen

SEARCHED	INDEXED
SERIALIZED	FILED
AUG 13 1971 FBI - SAN DIEGO	

(B)  
an

SAC, SAN DIEGO (174-428) (170-286)

7/30/71

SUPERVISOR ANTHONY J. MALONEY, JR.

JERRY LYNN DAVIS, aka.  
ET AL  
BOMBING MATTER  
(OO: San Diego)

SD 1155-R *informant*  
RM - MINUTEMEN

*informant*  
Re memo of Supervisor ANTHONY J. MALONEY, JR., dated 7/28/71 and memo of SA STEVEN L. CHRISTENSEN dated 7/29/71, captioned "SD 1155-R, RM - MINUTEMEN;" San Diego nitel to the Bureau dated 7/23/71, captioned "JERRY LYNN DAVIS, aka., ET AL, BOMBING MATTER."

On 7/30/71, I telephonically furnished the information contained in referenced memos to Mr. J. G. KELLY of the Civil Rights Section at the Bureau.

Mr. KELLY advised that the information contained in the memos should be incorporated in an LHM and furnished to the Bureau under the informant's caption.

*informant*  
Mr. KELLY further suggested that the results of the 7/23/71 conference between ATFD and the U.S. Attorney's Office, San Diego, be furnished to the Bureau in an LHM for transmittal to the Department. Mr. KELLY noted that the Department and the ATFD in Washington, D. C., feel that the delivery of the ~~illuminating~~ *illuminating* grenade by SD 1155-R to DAVIS would constitute a violation under ATFD jurisdiction. It was pointed out to Mr. KELLY that as set forth in referenced nitel, AUSA RISSO at San Diego disagreed with that view and did not consider such a set of facts a prosecutable violation.

The LHM should include information from ATFD or the informant to the effect that the ~~illuminating~~ *illuminating* grenade has or has not been delivered by the informant to subject DAVIS.

2 - 174-428  
② - 170-286

AJM:mt.  
(4)

170-286-70

SEARCHED	INDEXED
SERIALIZED	FILED
JUL 30 1971	
FBI - SAN DIEGO	

*Christensen*



UNITED STATES GOVERNMENT

# Memorandum

TO : SAC, SAN DIEGO (170-286)

DATE: 7/29/71

FROM : SA STEVEN L. CHRISTENSEN

SUBJECT: *Informant*  
SD 1155 - R  
RM - MM

Informant was recontacted this date. He advised he has continued to give the matter of relocation considerable thought. He pointed that his parents have, for some time, been trying to convince him of the desirability of moving to Hawaii. He explained that his parents have resided and visited in that state several times and are contemplating moving there permanently in the near future for health and business reasons.

He stated that he still feels that notwithstanding the foregoing, relocation at Boise, Idaho, would be more advantageous for him. He advised he would appreciate assistance from the Bureau in finding employment there.

Source further advised that on 7/27/71 the points required for selling a house with an FHA loan on it rose from 2 to 8. He said that his original estimate of the amount required for his move would, accordingly, be a little low.

1 - SD 170-286  
SLC/slc  
(1)

170-286-69

SEARCHED	INDEXED
SERIALIZED	FILED
JUL 30 1971	
FBI - SAN DIEGO	

*la*



Buy U.S. Savings Bonds Regularly on the Payroll Savings Plan

UNITED STATES GOVERNMENT

# Memorandum

TO : SAC, SAN DIEGO (170-286)

DATE: 7/28/71

FROM : SUPERVISOR ANTHONY J. MALONEY, JR.

SUBJECT: *informant*  
SD 1155-R  
RM - MINUTEMEN

*informant* Re San Diego airtel to the Bureau dated 7/28/71.  
On 7/28/71, Mr. and Mrs. CHARLES GODFREY, the parents of SD 1155-R, telephonically advised that they had discussed with their son their son's possible relocation to Boise, Idaho.

The parents stated that they were not satisfied with the possibility of their son's relocation to Boise and felt that in addition to the relocation, the FBI should secure a job for SD 1155-R in Boise comparable to the \$12,000 a year job he presently holds at San Diego.

*informant* Mr. and Mrs. CHARLES GODFREY *informant* intend to move to Hawaii for health reasons in the near future and suggested the possibility of relocating SD 1155-R to that state inasmuch as they feel there is an abundance of U. S. Government jobs in Honolulu, one of which the FBI could get for their son without too much difficulty.

During this conversation, Mr. GODFREY mentioned that he has many "friends" in Washington whom he would be glad to contact if it was felt it would help the FBI to help his son. The inference of this remark was interpreted as being that if the FBI did not help SD 1155-R, Mr. GODFREY might seek the assistance of his "friends" in Washington.

*informant* It was pointed out to the parents that as of 7/26/71, their son indicated that all he desired was relocation to Boise, but that their feelings in this matter would be made a matter of record.

No assurance of any sort was made to the parents of SD 1155-R.

*informant*  
② - San Diego

AJM:mt  
(2)

170-286-68

SEARCHED	INDEXED
SERIALIZED	FILED
JUL 28 1971	
FBI-SAN DIEGO	
<i>Christensen</i>	<i>Ull</i>



Buy U.S. Savings Bonds Regularly on the Payroll Savings Plan

CITY San Diego, California

DATE July 16, 1971

Request of Special Agent in Charge, FBI, San Diego

Two Hundred and Eighty-two dollars, and no cents,

(\$ 282.00), which money is to be paid by me on July 22, 1971

to informant  
SD 1155 - R

For information concerning the case entitled Minuteman Organization; JERRY LYNN DAVIS; FRANK YACOPEC; JAMES EVAN POTO; National Socialist White Peoples Party. Expenses incurred in use of personal automobile, and other miscellaneous purchases.

Services: \$ 245.00 Federal Income Tax Withheld \$ \_\_\_\_\_

Expenses \$ 37.00

Signed: Steven L. Christensen  
Special Agent

Authority (date) Bulet 12/8/70

Period Covered by Payment 5/1 - 31/71

Authorization Checked mal

Check Number 17350

Receipts Received 7/22/71

Voucher Prepared 7/26/71 Item 16

Date of Actual Payment XXXXXX 7/22/71

By whom SA STEVEN L. CHRISTENSEN

Informant's File No. 170-286

Approved [Signature]  
SAC

170-286-65  
SEARCHED \_\_\_\_\_ INDEXED \_\_\_\_\_  
SERIALIZED FB  
FBI - SAN DIEGO

CITY San Diego, California

DATE July 11, 1971

Request of Special Agent in Charge, FBI, San Diego

112 Hundred and ~~Seventy-four~~ forty-four dollars, and fonty-four cents,

(\$ 274.14), which money is to be paid by me on July 11, 1971

to informant  
SD 1155-R

for information concerning the case entitled Minuteman Organization; JERRY

LYNN DAVIS; San Diego Peace Action Coalition Demonstration, San  
Diego, California, 4/24/71.

Expenses incurred in use of personal automobile, telephone calls,  
postage, and purchase of miscellaneous items.

Services: \$ 235.00

Federal Income Tax Withheld \$ \_\_\_\_\_

Expenses \$ 39.14

Signed: Steven L. Christensen  
Special Agent

Authority (date) Bulet 12/8/70

Period Covered by Payment 4/1 to 30/71

Authorization Checked cah

Check Number 17328

Receipts Received 7/14/71

Voucher Prepared 7/19/71 Item 19

Date of Actual Payment 7/11/71

By whom SA STEVEN L. CHRISTENSEN

Informant's File No. 170p286

am Approved \_\_\_\_\_ SAC

170-286-64  
SEARCHED \_\_\_\_\_  
SERIALIZED BS BS  
FBI - San Diego

CITY San Diego, California

DATE June 18, 1971

Assistant  
Request of Special Agent in Charge, FBI, San Diego

Two Hundred and Thirty-two dollars, and Thirty cents,

(\$ 232.30), which money is to be paid by me on June 18, 1971

to informant  
SD 1755-R

for information concerning the case entitled Minuteman Organization; JERRY LYNN

DAVIS; ISAAC WILLIAM CANTRELL; Student Mobilization Committee.

Expenses were incurred in use of personal automobile, telephone calls, and miscellaneous purchases.

Services: \$ 205.00

Federal Income Tax Withheld \$ \_\_\_\_\_

Expenses \$ 32.30

Signed: Steven L. Christensen  
Special Agent

Authority (date) Bulet 12/8/70

Period Covered by Payment 3/1 - 31/71

Authorization Checked mal

Check Number 17266

Receipts Received 6/18/71 (6/22/71)

Voucher Prepared 6/23/71 Item 17

Date of Actual Payment 6/18/71

By whom SA STEVEN L. CHRISTENSEN

Informant's File No. 170-286

On Approved \_\_\_\_\_ SAC

170-286-63  
SEARCHED \_\_\_\_\_ INDEXED \_\_\_\_\_  
SERIALIZED JS \_\_\_\_\_  
JUN 20 1971  
FBI - SAN DIEGO

UNITED STATES GOVERNMENT

# Memorandum

TO : SAC, San Diego (170-286)

FROM : SA Steven L. Christensen

SUBJECT: ~~SD 1155-R~~  
RM-MM

DATE: 6/16/71

Attached are results of credit + arrest investigation conducted by SA John R. Baker on 6/14/71.

170-286-62

SEARCHED	INDEXED
SERIALIZED	FILED
JUN 16 1971	
FBI - SAN DIEGO	



5010-108

Buy U.S. Savings Bonds Regularly on the Payroll Savings Plan





Birth  Credit  Criminal  Motor Vehicle  Death  Marriage\*  INS

To \_\_\_\_\_ Buded \_\_\_\_\_  
Return to S. Whitstensen File number 100-14819  
Name and aliases of subject, applicant, or employee, and spouse

Howard Barry Godfrey

442-5213

Addresses

Residence 738 Grades, El Cajon, Cal.

Business Fireman, S.O. Fire Dept.

4582 Maple Ave., La Mesa. (6/68)

\*Date and place of marriage  
(if applicable)

Race <u>W</u>	Sex <input checked="" type="checkbox"/> Male <input type="checkbox"/> Female	Age <u>27</u>	Height <u>5'10"</u>	Weight <u>150</u>	Hair <u>Brn.</u>	Eyes <u>Brown/Hazel</u>
Birth date <u>7/1/43</u>	Birthplace <u>England (Portsmouth, Eng.)</u>					
Arrest Number	Fingerprint classification			Criminal specialty		

Specific information desired

Results of check

S.O. - 6-11-71 - N/R.

FPC:  
P.H. - CIA - I/31 W 111 16  
I/28 W 111 17  
(City Civil Service appli.)  
for fireman. 6/26/68

6/11/71



UNITED STATES GOVERNMENT

# Memorandum

TO : SAC San Diego (170-286)

DATE: 5/31/71

FROM : SA Steven L. Christensen

- TE
- CI
- SI
- R
- PC
- PCI
- PSI
- R (Prob)
- 

SUBJECT: informant  
SD 115F-R

**Dates of Contact**  
*Several contacts weekly during period 4/1 - 5/29/71*

**File # on which contacted (Use Titles if File #s not available or when CI provides positive information)**

157-1798

100-15731

157-2224

**Purpose and results of contact**

- NEGATIVE
- POSITIVE
- STATISTIC

*"C" memos prepared*

FORM 0-1

FILE # 170-286

DATE RECEIVED 6/3/71

DATE RETURNED 6/3/71

REPORT BY 6/4/71

Has informant shown any indication of emotional instability, unreliability or furnishing false information? No

170-286-59

Informant certified that he has furnished all information obtained by him since last contact.

Coverage  
*Racial & New Left*

**PERSONAL DATA**

SEARCHED  INDEXED

SERIALIZED  FILED

JUN 1 1971

San Diego

*an*

CITY San Diego, California

DATE April 22, 1971

Request of Special Agent in Charge, FBI, San Diego

Two Hundred and seventy-seven dollars, and fifty-one cents,

(\$ 277.51), which money is to be paid by me on April 22, 1971

to informant  
SD 1455 - R

for information concerning the case entitled Minuteman Organization; JERRY LYNN

DAVIS; Message Information Center; ISAAC WILLIAM CANTRELL;

PETER RUPLINGER; LEON NOWER. Expenses were incurred in use of

telephone, personal automobile, and purchase of miscellaneous

supplies and other articles.

Services: \$ 230.00

Federal Income Tax Withheld \$ \_\_\_\_\_

Expenses \$ 47.51

Signed: Steven L. Christensen  
Special Agent

Authority (date) Bulet 12/8/70

Period Covered by Payment 2/1 - 28/71

Authorization Checked mad

Check Number 17098

Receipts Received 4/22/71 (4/23/71)

Voucher Prepared 4/26/71 Item 19

Date of Actual Payment 4/22/71

By whom SA STEVEN L. CHRISTENSEN

Informant's File No. 170-286

an Approved \_\_\_\_\_  
SAC

170-286-58  
SEARCHED \_\_\_\_\_ INDEXED \_\_\_\_\_  
SERIALIZED \_\_\_\_\_ FILED \_\_\_\_\_  
APR 28 1971  
FBI - SAN DIEGO

UNITED STATES GOVERNMENT

# Memorandum

TO : SAC, San Diego (170-286)

DATE: 3/31/71

FROM : SA Steven L. Christensen

- TE
- CI
- SI
- R
- PC
- PCI
- PSI
- R (Prob)
- 

SUBJECT: *informant*  
SD1155-R

Dates of Contact  
*Several contacts weekly made during period 2/1 - 3/31/71*

File #s on which contacted (Use Titles if File # not available or when C provides positive information)

*157-1798*

*157-1614*

*157-2224*

*100-14273*

Purpose and results of contact

NEGATIVE

POSITIVE

STATISTIC

*"C" memos prepared*

Has informant shown any indication of emotional instability, unreliability or furnishing false information? *No*

Informant certified that he has furnished all information obtained by him since last contact.

Coverage  
*Racial - New Left*

PERSONAL DATA

*(Handwritten initials/signature)*

*170-286-57*

SEARCHED \_\_\_\_\_ INDEXED \_\_\_\_\_

SERIALIZED *2* FILED \_\_\_\_\_

APR - 1 1971

FBI - SAN DIEGO

UNITED STATES GOVERNMENT

# Memorandum

TO : SAC, SAN DIEGO (170-286)

DATE: 3/29/71

FROM : SA STEVEN L. CHRISTENSEN

SUBJECT: SD 1155-R *informant A*

Attached is the registration for the vehicle which followed informant on 3/21/71 as reported in mymemo of 3/22/71.

Index:

DAVID JOSEPH FRANCIS

JAMES FORREST BARBER

EARL ROBERT

1 - SD 170-286  
SLC/slc  
(1)

170-286-56

SEARCHED	INDEXED
SERIALIZED	FILED
MAR 31 1971	
FBI - SAN DIEGO	

*[Handwritten signature/initials over stamp]*

IV  
3A MC  
IV  
3A MDC762  
FBH

CLETS  
IV  
3A MDC762  
FBH

CLETS

*Christensen*

032271 0907  
FBH 0529  
IV FBH  
[

DATE: 03/22/71 TIME: 10:06  
REG :70 LIC#:MDC762 YRMD:58 MAKE:LINC BTM.:2DHTCA VIN#:H8YA409917  
R/O :FRANCIS DAVID JOSEPH/, BARBER JAMES FORREST/, ROBERT EARL,  
407 CHERRY ST CITY:IMPERIAL BCH C.C.:37 ZIP#:92032  
SOLD:00/00/55 I3SD:11/05/70 LDCD:5  
TYPE:11 CYL :08 SMOG:0 VEH :12 BODY:0 CLAS:00 FEB:0035 \*

END

UNITED STATES GOVERNMENT

# Memorandum

TO : SAC, SAN DIEGO (170-286)

DATE: 3/22/71

FROM : SA STEVEN L. CHRISTENSEN

SUBJECT: *informant*  
SD 1155-B  
SI

On 3/21/71 informant advised that while driving to his place of employment at approximately 7:30 AM that morning, he observed, while on IH 8, passing through La Mesa west-bound, that he was being followed by an older model Lincoln automobile. He said this vehicle was very distinctive in that the top and the front doors were painted dark blue with large white stars while the rest of the car was painted in red and white stripes. He said the vehicle followed him to IH 5, then to the Ardath Road exit along which informant attempted several evasive maneuvers without being able to lose the other car.

Informant said he finally stopped alongside the road whereupon the Lincoln stopped in the same block ahead of him. He said both he and the other driver got out and he observed the other was armed ~~with~~ with a metal club. Informant said he put his hand in the pocket of his jacket as though he had a pistol and told the other person to get back in his car or he would shoot. ~~xxxxxx~~ The individual complied, mumbling something about being unpatriotic and there being a lot of hostilities today. Informant described this person as a white male, 22 years of age, wearing a ponytail and Fu Manchu mustache. He had a large white husky dog in the car. He said the car was a 1958 model with California license MDC 762.

Informant advised he was subsequently contacted at work by Detective RONDE of the PD who advised the other driver had filed a complaint against informant for threat with a deadly weapon. He also complained informant had made an obscene gesture to him in La Mesa which he returned and then followed him 20 miles to find out why he did it. RONDE said the complainant's name is WILLIAM MARK STANLEY, and he indicated he had borrowed the car from a friend.

1 - SD 170-286  
SLC/slc  
(1)

170-286-55

SEARCHED	INDEXED
SERIALIZED	FILED
MAR 22 1971	
FBI - SAN DIEGO	

POHDE said STANLEY would have to return to the PD to indicate whether he wished to press charges against informant, and, in view of circumstances as reported by informant, doubted anything more would come of the matter.

CITY San Diego, California

DATE March 2, 1971

Request of Special Agent in Charge, FBI, San Diego

Two hundred and sixty-nine dollars, and twenty-four cents,

(\$ 269.24), which money is to be paid by me on March 3, 1971

to informant  
SD 1155 - R

for information concerning the case entitled Minuteman Organization; WILLIAM CLAY; JERRY LYNN DAVIS; Message Information Center; GEORGE HOOVER; Virtue In America; PAUL RUPLINGER; LOU CONDE. Expenses were incurred in the use of personal automobile, telephone calls, and purchase of miscellaneous supplies and other articles.

Services: \$ 235.00 Federal Income Tax Withheld \$ \_\_\_\_\_

Expenses \$ 34.24

Signed: Steven L. Christensen  
Special Agent

Authority (date) Bulet 12/8/70

Period Covered by Payment 1/1 - 31/71

Authorization Checked [Signature]

Check Number 16537

Receipts Received 3/3/71 (3/8/71)

Voucher Prepared 3/9/71 Item 12

Date of Actual Payment 3/3/71

By whom SA STEVEN L. CHRISTENSEN

Informant's File No. 170-286

170-286-54  
SEARCHED \_\_\_\_\_ INDEXED \_\_\_\_\_  
SERIALIZED \_\_\_\_\_ FILED \_\_\_\_\_  
MAR 1 1971  
FBI - SAN DIEGO

Approved [Signature]  
SAC



CITY San Diego, California

DATE February 18, 1971

Request of Special Agent in Charge, FBI, San Diego

248 hundred and forty-eight dollars, and ninety-seven cents,

(\$ 248.97), which money is to be paid by me on February 18, 1971

to informant SD 1155 - R

for information concerning the case entitled Minuteman Organization; WILLIAM CLAY; MARGERIE MC NICKLES; MESSAGE INFORMATION CENTER; STUDENT MOBILIZATION COMMITTEE; TROY HOUGHTON. Expenses were incurred in the use of personal automobile, purchase of literature and supplies, and other miscellaneous articles.

Services: \$ 225.00

Federal Income Tax Withheld \$ \_\_\_\_\_

Expenses \$ 23.97

Signed: Steven L. Christensen  
Special Agent

Authority (date) Bulet 12/8/70

Period Covered by Payment 12/1 - 31/1970

Authorization Checked mad

Check Number 16890

Receipts Received 2/18/71 (2/18/71)

Voucher Prepared 2/24/71 Item 19

Date of Actual Payment 2/18/71

By whom SA STEVEN L. CHRISTENSEN

Informant's File No. 170-286

Approved [Signature]  
SAC

170-286-53  
SEARCHED  
INDEXED  
SERIALIZED  
FILED  
FBI - SD

CITY San Diego, California

DATE January 29, 1971

Request of Special Agent in Charge, FBI, San Diego

Two hundred and sixty-one dollars, and forty-nine cents,

(\$ 261.49), which money is to be paid by me on January 29, 1971

to informant SD 1155-R

for information concerning the case entitled MINUTEMAN ORGANIZATION; GEORGE HOOVER; JERRY LYNN DAVIS; MESSAGE INFORMATION CENTER; STP DAY; MARGERIE MC MICKLES; ROBERT BOLIVAR DE PUGH. Expenses were for use of personal automobile, telephone calls, postage, and purchase of various supplies for Minuteman activities.

Services: \$ 210.00

Federal Income Tax Withheld \$ \_\_\_\_\_

Expenses \$ 51.49

Signed: Steven L. Christensen  
Special Agent

Authority (date) Bulet 6/18/70

Period Covered by Payment 11/1-30/70

Authorization Checked mark

Check Number 16839

Receipts Received 1/29/71 (2/1/71)

Voucher Prepared 2/2/71 Item 317

Date of Actual Payment 1/29/70

By whom SA STEVEN L. CHRISTENSEN

Informant's File No. 170-286

Approved [Signature]  
SAC

170-286-52  
SEARCHED \_\_\_\_\_  
SERIALIZED B B  
FBI - SAN DIEGO [Signature]

CITY San Diego, California

DATE January 15, 1971

Request of Special Agent in Charge, FBI, San Diego

Two hundred and thirty-six dollars, and sixtyone cents,

(\$ 236.61 ), which money is to be paid by me on January 15, 1971

to SD 1155 - Ruyfment

for information concerning the case entitled Minuteman Organization; WILLIAM CLAY;  
PAUL RUPLINGER; Message Information Center; Venceremos Brigade;  
Patriotic Action League; Marjorie McNichols; JERRY LYNN DAVIS;  
GEORGE WILLIAM HOOVER. Expenses for use of personal automobile,  
postage, telephone calls, purchase of miscellaneous articles.

Services: \$ 205.00

Federal Income Tax Withheld \$ \_\_\_\_\_

Expenses \$ 31.61

Signed Steven L. Christensen  
Special Agent

Authority (date) Bulet 6/18/70

Period Covered by Payment October 1 to 31, 1970

Authorization Checked [Signature]

Check Number 11787

Receipts Received 1/15/71 (1/27/71)

Voucher Prepared 2/2/71 Item 17.5

Date of Actual Payment January 15, 1971

By whom SA STEVEN L. CHRISTENSEN

Informant's File No. 170-286

Approved [Signature]  
SAC

170-286-51  
SEARCHED \_\_\_\_\_ INDEXED \_\_\_\_\_  
SERIALIZED R FILED 02  
FBI - SAN DIEGO

UNITED STATES GOVERNMENT

# Memorandum

TO : SAC San Diego (170-286)

DATE: 1/31/71

FROM : SA Steven L. Christensen

CI  SI  R (Prob)

PCI  PSI  R

SUBJECT: Informant  
50-1155-R

Dates of Contact

Several contacts weekly during 12/70 & 1/71

Titles and File #s on which contacted

157-1798 Minuteman Organization  
100-14273 New Left Movement

Purpose and results of contact

- NEGATIVE
- POSITIVE
- STATISTIC

"C" memos prepared

Informant certified that he has furnished all information obtained by him since last contact.

Rating

Excellent

Coverage

Racial - New Left

170-286-50

SEARCHED INDEXED  
SERIALIZED FILED  
FEB - 1 1971  
FBI - SAN DIEGO

CITY San Diego, California

DATE November 20, 1970

Request of Special Agent in Charge, FBI, San Diego

Two Hundred and Fifty-six dollars, and thirty-nine cents,

(\$ 256.39), which money is to be paid by me on ~~November 20, 1970~~ 1/7/71

to SD 1155-R *informant*

for information concerning the case entitled Minutman Organization; Legion of Justice; WILLIAM CLAY; PETER RUPLINGER; JERRY GEIER; Message Information Center; Visit of President RICHARD M. NIXON to Coronado, California, 11/3/70. Expenses incurred were for use of personal automobile, telephone calls, and purchase of other miscellaneous articles.

Services: \$ 230.00 Federal Income Tax Withheld \$ \_\_\_\_\_

Expenses \$ 26.39

Signed *Steven L. Christensen*  
Special Agent

Authority (date) Bulet 6/18/70

Period Covered by Payment September 1 - 30, 1970

Authorization Checked *[Signature]*

Check Number 16629

Receipts Received 1/7/71 (1/11/71)

Voucher Prepared 1/13/71 Item 20

Date of Actual Payment ~~November 20, 1970~~ 1/7/71

By whom SA STEVEN L. CHRISTENSEN

Informant's File No. 170-286

Approved *[Signature]*  
SAC

170-286-49  
SEARCHED  
B B  
FBI - SD

UNITED STATES GOVERNMENT

# Memorandum

TO : SAC, San Diego (170-286)

FROM : SA Steven L. Christensen

SUBJECT: SD Informant  
1155-R

DATE: 11/30/70

- CI
- SI
- R (Prob)
- PCI
- PSI
- R
- 

**Dates of Contact**  
*Contact several times weekly during period 10/1 - 11/30/70*

**File #s on which contacted (Use Titles when File #s not available or C/positive info.)**

<i>100-14273</i>	<i>New Left Movement</i>
<i>157-</i>	<i>Mishkwan Organization</i>

**Purpose and results of contact**

NEGATIVE

POSITIVE

STATISTIC

*"C" memos prepared*

*[Signature]*

Informant certified that he has furnished all information obtained by him since last contact.

Coverage  
*Racial + New Left*

PERSONAL DATA

170-286-47

SEARCHED	INDEXED
SERIALIZED	FILED
DEC 1 1970	
FBI - SAN DIEGO	

UNITED STATES GOVERNMENT

# Memorandum

TO : SAC

DATE: 11/14

FROM : Inspector

SUBJECT: *informant*  
*SD-455-R*

CI PCI TE PC GHETTO (PROB)  
SI PSI RI RI (PROB)

137 -  
134 -  
170 -

The file pertaining to the above-captioned informant has been reviewed by the Inspection Staff, and the informant has been rated as:

- Excellent
- Very Good
- Good
- Fair
- Poor
- Insufficient Data to Rate

You are referred to the appropriate survey for instructions as to those informants rated "Poor." If rated "Fair," this matter should be followed closely by you for 90 days. Specific assignments should be given the informant during this period. If, at the end of 90 days, no positive-improvement is shown, the file should be closed. The Bureau should be advised of the action taken as to those informants rated "Fair," i.e., were they closed out or did they become productive.

Remarks:

170-286-45

SEARCHED	INDEXED
SERIALIZED	FILED
NOV 1 1977	
FBI - SAN DIEGO	

*[Handwritten signature]*

CITY San Diego, California

DATE October 16, 1970

Request of Special Agent in Charge, FBI, San Diego

Two Hundred and Forty-four dollars, and forty-four cents,

(\$ 244.44), which money is to be paid by me on October 16, 1970

to Informant  
SD 155-R

for information concerning the case entitled National Yippie Day at Disneyland;

PETER RUPLINGER; LEON NOWER; American Volunteer Group; WILLIAM

CLAY; FRANK YACOPEC; San Diego Street Journal; JERRY TARTAGLIO.

Expenses were incurred in use of personal automobile, purchase of

stamps and other articles and supplies, newspapers and telephone

calls.

Services: \$ 215.00

Federal Income Tax Withheld \$ \_\_\_\_\_

Expenses \$ 29.44

Signed: Steven L. Christensen  
Special Agent

Authority (date) Bulet 6/18/70

Period Covered by Payment August 1 to August 31, 1970

Authorization Checked na

Check Number 16524

Receipts Received 10/16/70 (10/19/70) <sup>10/19</sup>

Voucher Prepared 10/21/70 Item 10

Date of Actual Payment 10/16/70

By whom SA STEVEN L. CHRISTENSEN

Informant's File No. 170-286

Approved [Signature]  
SAC

SEARCHED  
SERIALIZED  
OCT  
FBI-SAN



CITY San Diego, California

DATE September 28, 1970

Request of Special Agent in Charge, FBI, San Diego

Two Hundred and Forty-six dollars, and Seventy cents,

(\$ 246.70 ), which money is to be paid by me on September 28, 1970

to *informant*  
SD 1155-R

for information concerning the case entitled Minuteman Organization; Frank Yacopec; William Clay; Message Information Center; Demonstration, July 4, 1970, San Diego, California; Dale Herschler; San Diego Street Journal. Expenses incurred in use of personal automobile, telephone calls, purchases of miscellaneous articles and supplies.

Services: \$ 210.00

Federal Income Tax Withheld \$ \_\_\_\_\_

Expenses \$ 36.70

Signed: *Steven L. Christensen*  
Special Agent

Authority (date) Bulet 6/18/70

Period Covered by Payment July 1, 1970 to July 31, 1970

Authorization Checked *mal*

Check Number 16452

Receipts Received 9/28/70 (9/29/70) <sup>9/29</sup>

Voucher Prepared 10/5/70 Item 3

Date of Actual Payment September 28, 1970

By whom SA STEVEN L. CHRISTENSEN

Informant's File No. 170-286

Approved *[Signature]*  
SAC

170-286-43  
SEARCHED \_\_\_\_\_ INDEXED \_\_\_\_\_  
SERIALIZED \_\_\_\_\_ FILED \_\_\_\_\_  
OCT 5 1970  
FBI - SAN DIEGO

UNITED STATES GOVERNMENT

# Memorandum

TO : SAC, *San Diego* *170-286*

DATE: *9/30/70*

FROM : SA *Steen L. Christensen*

- CI  SI  R (Prob)
- PCI  PSI  R
- 

SUBJECT: *informant*  
*50(153)-R*

**Dates of Contact**  
*Contact several times weekly during period 8/1 - 9/30/70*

**File #s on which contacted (Use Titles when File #s not available or CI positive info.)**

<i>100-14273</i>	<i>New Left Movement</i>
<i>100-17466</i>	<i>Minuteman Organization</i>

**Purpose and results of contact**

NEGATIVE  
 POSITIVE  
 STATISTIC

*sub in "A" file*

Informant certified that he has furnished all information obtained by him since last contact.

**PERSONAL DATA**

Coverage  
*Racial*

*Perce*

SEARCHED INDEXED  
SERIALIZED FILED  
OCT 1 1970  
FBI - SAN DIEGO

*170-286-42*

CITY San Diego, California

DATE July 22, 1970

Request of Special Agent in Charge, FBI, San Diego

Thirty-nine dollars, and forty-seven cents,

(\$ 39.47), which money is to be paid by me on July 22, 1970

to informant  
SD 1155 - R

for information concerning the case entitled Minuteman Organization; Frank Yacopec; Orange County True Press; George Hoover; William Clay; Peter Ruplinger; San Diego Street Journal. Expenses incurred in use of personal automobile, telephone calls and purchase of literature, papers and other supplies.

Services: \$ 0.00 Federal Income Tax Withheld \$ \_\_\_\_\_

Expenses \$ 39.47

Signed: Steven L. Christensen  
Special Agent

Authority (date) Bulet 6/18/70

Period Covered by Payment June 1, 1970 - June 30, 1970

Authorization Checked 16300

Check Number MAH

Receipts Received 7/22/70 (8/3/70)

Voucher Prepared 8/6/70 Item 4

Date of Actual Payment July 22, 1970

By whom SA STEVEN L. CHRISTENSEN

Informant's File No. 170-236

Approved [Signature]  
SAC

170-236-41  
SEARCHED \_\_\_\_\_ INDEXED \_\_\_\_\_  
SERIALIZED [initials] FILED [initials]  
JUL 23 1970  
FBI - SAN DIEGO

CITY San Diego, California

DATE July 10, 1970

Request of Special Agent in Charge, FBI, San Diego

Two hundred----- dollars, and no----- cents,

(\$ 200.00), which money is to be paid by me on July 10, 1970

to Informant  
SD(1155 - R)

for information concerning the case entitled Minuteman Organization, RM - MM;  
WILLIAM CLAY, RM - MM; JERRY LYNN DAVIS, SM - MM; JERRY BUSCH,  
RM - MM; Stockpiling of Arms and Ammunition, RM \* MISC.; San  
Diego Street Journal, IS - MISC.

Services: \$ 200.00 Federal Income Tax Withheld \$ \_\_\_\_\_

Expenses \$ \_\_\_\_\_

Signed: Steven L. Christensen  
Special Agent

Authority (date) Bulet 6/18/70

Period Covered by Payment 6/1 - 30/70

Authorization Checked [Signature]

Check Number 16269

Receipts Received 7/10/70 (7/22/70)

Voucher Prepared 7/23/70 Item 5

Date of Actual Payment 7/10/70

By whom SA STEVEN L. CHRISTENSEN

Informant's File No. 170-236

Approved [Signature]  
SAC

170-236-40  
SEARCHED \_\_\_\_\_ INDEXED \_\_\_\_\_  
SERIALIZED [initials] FILED [initials]  
JUL 13 1970  
FBI - SAN DIEGO

CITY San Diego, California

DATE June 2, 1970

Request of Special Agent in Charge, FBI, San Diego, California

One Hundred and twelve dollars, and no----- cents,

(\$ 112.00), which money is to be paid by me on June 3, 1970

to SD 1155 - R

for information concerning the case entitled Minuteman Organization, IS - MM;  
WILLIAM GLAY, SM - MM; FRANK YACOPEC, SM - MM; ROTC Sit-In,  
San Diego State College, IS - MISC.; Demonstrations, May, 1970,  
to Protest the Military, IS - MISC.; Teach-In on Political  
Oppression, San Diego State College, 5/18/70, IS - MISC.

Expenses are for mileage on personal automobile and other  
miscellaneous purchases made in connection with services rendered.

Services: \$ 100.00 Federal Income Tax Withheld \$ \_\_\_\_\_

Expenses \$ 12.00

Signed: Steven L. Christensen  
Special Agent

Authority (date) SD let 11/17/69; app. 12/2/69

Period Covered by Payment 5/1 - 31/70

Authorization Checked Trab

Check Number 16156

Receipts Received 6/3/70 (7/22/70)

Voucher Prepared 7/23/70 Item 2

Date of Actual Payment 6/3/70

By whom SA STEVEN L. CHRISTENSEN

Informant's File No. 170-286

Approved [Signature]  
SAC

170-286-39  
SEARCHED \_\_\_\_\_ INDEXED \_\_\_\_\_  
SERIALIZED FILED  
JUL 5 1970  
FBI - SAN DIEGO

CITY San Diego, California

DATE June 2, 1970

Request of Special Agent in Charge, FBI, San Diego, California

One Hundred and fourteen dollars, and thirteen cents,

(\$ 114.13), which money is to be paid by me on June 2, 1970

to informant  
SD/1155 - R

for information concerning the case entitled Minuteman Organization, IS - MM;  
WILLIAM CLAY, SM - MM; April 15th. Demonstration against the  
War in Vietnam, IS - ANA (VIDEM); Movement for a Democratic  
Military, IS - ANA; Peoples Commune, IS - ANA.

Expenses are for mileage on personal automobile, telephone calls  
and other miscellaneous expenses and purchases.

Services: \$ 100.00 Federal Income Tax Withheld \$ \_\_\_\_\_

Expenses \$ 14.13

Signed: Steven L. Christensen  
Special Agent

Authority (date) SD let 11/17/69; app. 12/2/69.

Period Covered by Payment 4/1/70 - 4/30/70

Authorization Checked [Signature]

Check Number 16157

Receipts Received 6/3/70 (7/23/70)

Voucher Prepared 7/23/70 Item 1

Date of Actual Payment 6/3/70

By whom SA STEVEN L. CHRISTENSEN

Informant's File No. 170-286

Approved [Signature]  
SAC

170-286-38  
SEARCHED \_\_\_\_\_ INDEXED \_\_\_\_\_  
SERIALIZED [initials] FILED [initials]  
JUL 2 1970  
FBI - SAN DIEGO

UNITED STATES GOVERNMENT

# Memorandum

TO : SAC, San Diego (170-286) DATE: 7/31/70

FROM : SA Steven L. Christensen  CI  SI  R (Prob)

SUBJECT: SD informant  
MISS-K  PCI  PSI  R

Dates of Contact	
Contact several times weekly during 6/1 - 7/31/70	
File #s on which contacted (Use Titles when File #s not available or CI positive info.)	
100-14273	New Left Movement
100-12461	Minuteman Organization
100-14293	William Clay
100-14376	Street Journal

Purpose and results of contact

NEGATIVE  
 POSITIVE  
 STATISTIC

Info in "A" file

Informant certified that he has furnished all information obtained by him since last contact.

Coverage  
Racial + Newleft

PERSONAL DATA

SEARCHED \_\_\_\_\_ INDEXED \_\_\_\_\_  
SERIALIZED 7 FILED 13  
AUG - 1 1970  
FBI - SAN DIEGO

1-137-159

UNITED STATES GOVERNMENT

# Memorandum

TO : SAC, San Diego (170-286)

FROM : SA Steven L. Christensen

SUBJECT: SD 1155 - Ruffinment

DATE: 5/29/70

- CI
- SI
- R (Prob)
- PCI
- PSI
- R
- 

Dates of Contact <i>Contacted several times weekly period 1/1/70 - 5/28/70</i>	
File #s on which contacted (Use Titles when File #s not available or CI positive info.)	
<i>100-14273</i>	<i>New Left Movement</i>
<i>100-14364</i>	<i>James Evan Pisto</i>
<i>100-12461</i>	<i>Minutemen Organization</i>
<i>100-14293</i>	<i>William Clark</i>
<i>100-14911</i>	<i>Peoples Commune</i>
<i>100-14506</i>	<i>Free Door</i>
Purpose and results of contact <input type="checkbox"/> NEGATIVE <input checked="" type="checkbox"/> POSITIVE <input type="checkbox"/> STATISTIC  <div style="text-align: center; font-size: 2em; font-family: cursive;">C</div> <i>memos prepared</i>	
<input checked="" type="checkbox"/> Informant certified that he has furnished all information obtained by him since last contact.	Coverage <i>Racial (MM); New Left</i> <i>170-286-34</i>
PERSONAL DATA <div style="text-align: center; font-size: 4em; font-family: cursive;">P</div>	<div style="border: 1px solid black; padding: 5px; text-align: center;">           SEARCHED _____ INDEXED _____            SERIALIZED <i>7</i> FILED <i>173</i>  <b>JUN - 1 1970</b>            FBI - SAN DIEGO         </div>



CITY San Diego, California

DATE April 24, 1970

Request of Special Agent in Charge, FBI, San Diego, California

One hundred and twenty-one dollars, and ninety-three cents,

(\$ 121.93), which money is to be paid by me on April 24, 1970

to SD 1155 - R informant

for information concerning the case entitled Minuteman Organization, IS - MM;  
WILLIAM CLAY, SM - MM; FRANK YACOPEC, SM - MM; GERALD TARTAGLIO,  
SM - MM; BETTIE HOUGHTON, SM - MM; JERRY GEIER, SM - MM; San Diego  
Free Door to Liberation, IS - Misc.; PEOPLES COMMUNE, IS - ANA;  
San Diego Street Journal, IS - Misc.

Expenses are for mileage on personal automobile, purchasing and  
processing photographic film, and other miscellaneous purchases in  
connection with services performed.

Services: \$ 100.00

Federal Income Tax Withheld \$ \_\_\_\_\_

Expenses \$ 21.93

Signed: Steven L. Christensen  
Special Agent

Authority (date) Bulet 11-17-69; App. 12-2-69

Period Covered by Payment 3/1 - 31/70

Authorization Checked nd

Check Number 16031

Receipts Received 4/24/70 (4/30/70)

Voucher Prepared 5-11-70 Item 5

Date of Actual Payment ~~XXXXXX~~ 4/24/70

By whom SA STEVEN L. CHRISTENSEN

Informant's File No. 170-286

Approved [Signature]  
SAC

SEARCHED _____	INDEXED _____
SERIALIZED <u>FILED</u>	_____
MAY 12 1970	
FBI - SAN DIEGO	

CITY San Diego, California

DATE March 30, 1970

Request of Special Agent in Charge, FBI, San Diego

124 hundred and twenty-four dollars, and thirty-three cents,

(\$ 124.33), which money is to be paid by me on 3/30/70

to informant  
SD 1155 - R

for information concerning the case entitled Minuteman Organization, IS - MM (100-12461); New Left Movement, IS - ANA (100-14273); People's Commune, IS - ANA (100-14911); Student Demonstration, San Diego State College, 3/12/70 (100-14998); Dale Herschler, SM - R (157-800). Informant

also provided visual and photographic coverage of demonstration in downtown San Diego on 2/27/70. Expenses are for travel and other purchases necessary to services rendered.

Services: \$ 100.00 Federal Income Tax Withheld \$ \_\_\_\_\_

Expenses \$ 24.33

Signed: Steven L. Christensen  
Special Agent

Authority (date) SD  
Delet 11-17-69 (P.A.). 12-2-69

Period Covered by Payment 2/1 - 28/70

Authorization Checked mk

Check Number 15956

Receipts Received 3/30/70 (4-30-70)

Voucher Prepared 5-11-70 Item 1

Date of Actual Payment 3/30/70

By whom SA STEVEN L. CHRISTENSEN

Informant's File No. 179 - 286

Approved [Signature]  
SAC

SEARCHED _____	INDEXED _____
SERIALIZED <u>17</u>	FILED <u>17</u>
MAY 11 1970	
FBI - SAN DIEGO	

CITY SAN DIEGO, CALIFORNIA

DATE March 3, 1970

Request of Special Agent in Charge, FBI, San Diego Division

One hundred and sixteen dollars, and twenty-nine cents,

(\$ 116.29), which money is to be paid by me on March 3, 1970

to informant  
SD 1155

for information concerning the case entitled Minuteman Organization, IS - MM;

WILLIAM CLAY, SM - MM; FRANK YACOPEC, SM - MM; Movement for  
a Democratic Military, IS - Misc.; New Left Movement, IS - ANA.

Expenses are for travel and other purchases made in connection  
with services rendered.

Services: \$ 100.00 Federal Income Tax Withheld \$ -----

Expenses \$ 16.29

Signed: Steven L. Christensen  
Special Agent

Authority (date) SO let 11/17/69  
Bulet 12/2/69

Period Covered by Payment 1/1 - 31/70

Authorization Checked Ind

Check Number 15874

Receipts Received 3-3-70 (V.V. 10)

Voucher Prepared 4/21/70 Item 1

Date of Actual Payment 3/3/70

By whom SA STEVEN L. CHRISTENSEN

Informant's File No. ~~131-911~~ 170-286

Approved [Signature]  
SAC

31

170-286-29

SEARCHED	INDEXED
SERIALIZED	FILED
FBI - SAN DIEGO	



UNITED STATES GOVERNMENT

# Memorandum

TO : SAC, San Diego (134-914) DATE: 1/30/70

FROM : SA Steven L. Christensen  CI  SI  R (Prob)

SUBJECT: informant  
SD 9155-S  PCI  PSI  R

Dates of Contact

11/15/69; 11/29/69; 12/13/69; 12/29/69; 1/11/70; 1/30/70

Titles and File #s on which contacted

MM Organization	100-12461
New Leaf	100-14273

Purpose and results of contact

- NEGATIVE
- POSITIVE
- STATISTIC

"C" Memos prepared

3/18/70  
make case  
170

Christensen ML

Informant certified that he has furnished all information obtained by him since last contact.

Rating: Excellent

Coverage: Security Matters

1-134-914

check  
3/18/70

134-914-24

SEARCHED	INDEXED
SERIALIZED	FILED
FEB - 2 1970	
FBI - SAN DIEGO	

170-286-29

CITY San Diego, California

DATE January 16, 1970

Request of Special Agent in Charge, FBI, San Diego Division

One hundred and twenty-two dollars, and forty-three cents,

(\$ 122.43), which money is to be paid by me on January 16, 1970

to Informant  
SD 1155 - S

for information concerning the case entitled Minuteman Organization, IS-MM;  
WILLIAM CLAY, SM-MM; LYLE HANNING, SM-MM; TROY HOUGHTON, SM-MM;  
BETTIE HOUGHTON, SM-MM; PEOPLE'S COMMUNE, IS-ANA; DALE HERSCHLER,  
RM; SAN DIEGO STREET JOURNAL, IS-MISC., (NEW LEFT - UNDERGROUND  
NEWSPAPER)

Expenses are for travel and purchases of literature and other materials in connection with services performed.

Services: \$ 100.00

Federal Income Tax Withheld \$ \_\_\_\_\_

Expenses \$ 22.43

Signed Steven L. Christensen  
Special Agent

Authority (date) ~~Bulet~~ SD let 11/17/69 (Appvd. 12/2/69)

Period Covered by Payment 12/1 - 31/69

Authorization Checked gml

Check Number 15729

Receipts Received 1/16/70 (1/23/70)

Voucher Prepared 1/30/70 Item 11

Date of Actual Payment 1/16/70

By whom SA STEVEN L. CHRISTENSEN

Informant's File No. 134-914

Approved [Signature]  
SAC

170-286-28  
34-9-11-15  
SEARCHED \_\_\_\_\_ INDEXED \_\_\_\_\_  
SERIALIZED 32 FILED \_\_\_\_\_  
JAN 30 1970  
FBI - SAN DIEGO

CITY San Diego, California

DATE December 15, 1969

Assistant  
Request of Special Agent in Charge, FBI, San Diego

One hundred-nineteen dollars, and thirty-six cents,

(\$ 119.36), which money is to be paid by me on December 15, 1969

to Informant  
SP-1155 - S

for information concerning the case entitled Minuteman Organization, IS - MM;

WILLIAM CLAY, SM - MM; LYLE MANNING, SM - MM; DEMNOV, IS - Misc.

Informant provided important information relating to activities of above including photographic coverage of the November 15th demonstrations. In addition informant has provided limited information regarding the activities of the San Diego Free Press and the San Diego Free Door.

Services: \$ 100.00

Federal Income Tax Withheld \$ \_\_\_\_\_

Expenses \$ 19.36

Signed: Steven L. Christensen  
Special Agent

Authority (date) Bulet 7-2-69

Period Covered by Payment 11/1 -30/69

Authorization Checked mel

Check Number 15646

Receipts Received 12/15/69 (12/16/69)

Voucher Prepared 1/5/70 Item 0

Date of Actual Payment 12/15/69

By whom SA STEVEN L. CHRISTENSEN

Informant's File No. 134-914

Approved \_\_\_\_\_  
SAC

170-256-27  
134-914-27  
SEARCHED \_\_\_\_\_ INDEXED \_\_\_\_\_  
SERIALIZED \_\_\_\_\_ FILED \_\_\_\_\_  
JAN 5 1970  
FBI - SAN DIEGO

CITY San Diego, California

DATE November 10, 1969

Request of Special Agent in Charge, FBI, San Diego

One hundred and sixteen--dollars, and ~~-----~~ fifty ----- cents,

(\$ 116.50), which money is to be paid by me on November 10, 1969

to *Informant*  
SD 1155 - S

for information concerning the case entitled October 15th Committee (100-14794)  
Minuteman Organization (100-12461); DEMNOV (100- 14736); San Diego  
FREE DOOR 9157-800); WILLIAM CLAY (100-14293); LYLE MANNING (100-14299)

Informant has provided coverage of members of the Minuteman Organization  
and other "right wing" groups in the area. He has reported on activitie  
of the underground newspaper, The San Diego Free Door to Liberation,  
and advised of its change of address. Informant provided visual as  
well as photographic coverage of the October 15th Moratorium events  
at San Diego State College including activities leading up to the  
Moratorium on previous days.

Services: \$ 95.00 Federal Income Tax Withheld \$ -----

Expenses \$ 21.50

Signed: *Steven L. Christensen*  
Special Agent

Authority (date) Bulet 7/2/69

Period Covered by Payment 10/1 - 31/69

Authorization Checked *Sub*

Check Number 15551

Receipts Received 11/10/69 (11/17/69)

Voucher Prepared 11/24/69 Item 2

Date of Actual Payment 11/10/69

By whom SA STEVEN L. CHRISTENSEN

Informant's File No. 134-914

Approved *[Signature]*  
SAC

170-286-25  
134-914-25  
SEARCHED    INDEXED     
SERIALIZED    FILED     
NOV 2 1969  
FBI - SAN DIEGO



UNITED STATES GOVERNMENT

# Memorandum

TO : SAC San Diego

FROM : SA Steven L. Christensen

SUBJECT: SD 1155-Summit

DATE: 10/31/69

- CI  SI  R (Prob)
- PCI  PSI  R
- 

Dates of Contact	9/8 ; 9/12 ; 9/18 ; 10/8 ; 10/10 ; 10/20 ; 10/30/69	
Titles and File #s on which contacted	Minuteman Organization	100-12461
	Paul Ruffinger	100-14301
	Bill Clay	100-14293
	Oct. 15 Committee to End the War	100-14794

Purpose and results of contact

- NEGATIVE
- POSITIVE
- STATISTIC

11 "C" memos prepared

Please show SA Arnold O'Brien as Alternate Agent.

Informant certified that he has furnished all information obtained by him since last contact.

Rating  
Excellent

Coverage  
Minuteman, & Newleft activities  
170-256-23

SEARCHED	INDEXED
SERIALIZED	FILED
OCT 31 1969	
FBI - SAN DIEGO	

134-974-23

UNITED STATES GOVERNMENT

# Memorandum

TO : SAC

DATE: 10/29/69

FROM : Inspector

SUBJECT: *Informant*  
*SD 1155-S*

CI	PCI	TE	PC	GHETTO (PROB)
<u>SI</u>	PSI	RI	RI (PROB)	

137 -  
134 - 914  
170 -

The file pertaining to the above-captioned informant has been reviewed by the Inspection Staff, and the informant has been rated as:

- Excellent
- Very Good
- Good
- Fair
- Poor
- Insufficient Data to Rate

You are referred to the appropriate survey for instructions as to those informants rated "Poor." If rated "Fair," this matter should be followed closely by you for 90 days. Specific assignments should be given the informant during this period. If, at the end of 90 days, no positive improvement is shown, the file should be closed. The Bureau should be advised of the action taken as to those informants rated "Fair," i.e., were they closed out or did they become productive.

Remarks:

*J.P. Baker*

170-286-22  
~~134-914-02~~

SEARCHED	INDEXED
SERIALIZED	FILED
OCT 29 1969	
FBI - SAN DIEGO	
<i>S. Christensen</i>	

CITY San Diego, California

DATE October 10, 1969

Request of Special Agent in Charge, FBI, San Diego, California

Fifty-seven----- dollars, and forty-nine----- cents,

(\$ 57.49 ), which money is to be paid by me on October 10, 1969

to SD 1155 informant

for information concerning the case entitled Minuteman Organization, 100-12461.

WILLIAM CHARLES CLAY, 100-14293. LYLE JACK MANNING, 100-1R299.

Informant furnished information regarding activities of the

Minuteman Organization, separation of CLAY from his wife and

change of address. Manning's letter to President NIXON threatening

Services: \$ 45.00 to blow up the Berkeley Barb.

(8/1-31/69-225; 9/1-30/69-20) Federal Income Tax Withheld \$

Expenses \$ 12.49

(8/1-31/69-26.49)

(9/1-30/69-26.00)

Signed: Steven L. Christensen  
Special Agent

Authority (date) Bulet 7/2/69

Period Covered by Payment 8/1 - 9/30/69

Authorization Checked Sub

Check Number 15457

Receipts Received 10/10/69 (10/20/69)

Voucher Prepared 10/24/69 Item 1

Date of Actual Payment 10/10/69

By whom SA STEVEN L. CHRISTENSEN

Informant's File No. 134-911

Approved S  
SAC

170-246-21  
134-914-21  
SEARCHED \_\_\_\_\_ INDEXED \_\_\_\_\_  
SERIALIZED PS FILED PS  
OCT 13 1969  
FBI - SAN DIEGO

UNITED STATES GOVERNMENT

# Memorandum

TO : SAC San Diego (134-914)

DATE: 8/29/69

FROM : SA Steven L. Christensen

CI  SI  R (Prob)

PCI  PSI  R

SUBJECT: ~~SD/134-914~~

Dates of Contact	6/11/69
6/4/69, 7/17/69, 7/30/69, 8/6/69, 8/17/69, 8/29/69	
Titles and File #s on which contacted	
Minkman Organization	100-12461

Purpose and results of contact

NEGATIVE  
 POSITIVE  
 STATISTIC

Info in "C" memos

170-286-20  
~~134-914-20~~

<input checked="" type="checkbox"/> Informant certified that he has furnished all information obtained by him since last contact.	Rating Excellent	Coverage Security - Minkman
---	---------------------	--------------------------------

SEARCHED	INDEXED
SERIALIZED	FILED
JUL 1969	
FBI - SAN DIEGO	

CITY San Diego, California

DATE August 5, 1969

Request of Special Agent in Charge, FBI, San Diego, California

Eighty-one --- dollars, and Forty-three --- cents.

(\$ 81.43 ), which money is to be paid by me on August 5, 1969

to sd informant

for information concerning the case entitled The Minuteman Organization

Expenses are for travel, telephone calls, purchases, and miscellaneous expenses in connection with coverage of the Minuteman Organization and related groups.

Services: \$ 16 65.00 Federal Income Tax Withheld \$ \_\_\_\_\_

Expenses \$ 16.43

Signed: Steven R. Christensen  
Special Agent

Authority (date) Bulet 7-2-69

Period Covered by Payment 7/1-31/69

Authorization Checked Incl

Check Number 15264

Receipts Received 8/5/69 (8/12/69)

Voucher Prepared 8/13/69 Item 6

Date of Actual Payment 8/5/69

By whom Sa Christensen

Informant's File No. 134-911

Approved [Signature]  
SAC

70-286-19  
134-911-19  
SEARCHED \_\_\_\_\_ INDEXED \_\_\_\_\_  
SERIALIZED \_\_\_\_\_  
FBI - SAN DIEGO

CITY San Diego, California

DATE June 11, 1969

Request of Special Agent in Charge, FBI, San Diego, California

Seventy-nine dollars, and sixty cents,

(\$ 79.60 ), which money is to be paid by me on June 12, 1969

to adjustment SD 1155 - S

for information concerning the case entitled Minutemen Organization, 100-121461;  
DePugh Bank Robbery, 91-3149; Berkeley Memorial Days Committee,  
100-14603.

Services: \$ 70.00 Federal Income Tax Withheld \$ \_\_\_\_\_

Expenses \$ 9.60

Signed: Steven L. Christensen  
Special Agent

Authority (date) Bulet 12/6/68

Period Covered by Payment 4/6 - 5/30/69

Authorization Checked Jes.

Check Number 15093

Receipts Received 6/12/69 (8/12/69)

Voucher Prepared 8/13/69 Item 1

Date of Actual Payment 6/12/69

By whom SA STEVEN L. CHRISTENSEN

Informant's File No. 134-914

Approved \_\_\_\_\_  
SAC

170-286-15  
134-914-18  
SEARCHED \_\_\_\_\_ INDEXED \_\_\_\_\_  
SERIALIZED 722  
1969  
FBI - SAN DIEGO

UNITED STATES GOVERNMENT

# Memorandum

TO : SAC San Diego (134-914)

DATE: 5/29/69

FROM : SA Steven L. Christensen

CI  SI  R (Prob)

PCI  PSI  R

SUBJECT: ~~SD 1155~~ informant

Dates of Contact	
4/18/69; 5/7/69; 5/23/69	
Titles and File #s on which contacted	
Minuteman Organization	100-12461
DePugh BR	91-3149
Berkeley Mem. Days Comm.	100-14603

Purpose and results of contact

NEGATIVE  
 POSITIVE  
 STATISTIC

"C" memos prepared  
 Make SA Arnold W. O'Brien  
 Alternate Agent.

170-280-15  
 134-914-15

SEARCHED _____	INDEXED _____
SERIALIZED _____	FILED _____
MAY 29 1969	
FBI - SAN DIEGO	

<input checked="" type="checkbox"/> Informant certified that he has furnished all information obtained by him since last contact.	Rating Excellent	Coverage Minuteman's office Right wing activities - Activities of New Left & Radical Organization
---	---------------------	---

FORM 0-1

6/17/69  
 6/16  
 6/13

CITY SAN DIEGO, CALIFORNIA

DATE May 7, 1969

Request of Special Agent in Charge, FBI, SAN DIEGO

Fifty dollars, and no cents,

(\$ 50.00), which money is to be paid by me on May 7, 1969

to informant  
SD 1155 - S

for information concerning the case entitled POLITICAL OPPRESSION TEACH-IN, San  
Diego State College, May 5, 1969.

Services: \$ 37.50 Federal Income Tax Withheld \$ \_\_\_\_\_

Expenses \$ 12.50

Signed: Steven L. Christensen  
Special Agent

Authority (date) Bulet 12/6/68

Period Covered by Payment 4/1 5/5/69

Authorization Checked Incl

Check Number 14965

Receipts Received 5/7/69 (5/7/69)

Voucher Prepared 5/9/69 Item 16

Date of Actual Payment 5/7/69

By whom SA STEVEN L. CHRISTENSEN

Informant's File No. 134-914

Approved \_\_\_\_\_  
SAC

170-286-14  
134-914-141  
SEARCHED \_\_\_\_\_ INDEXED \_\_\_\_\_  
SERIALIZED \_\_\_\_\_ FILED \_\_\_\_\_  
MAY 9 1969  
FBI - SAN DIEGO



CITY San Diego, California

DATE April 18, 1969

Request of Special Agent in Charge, FBI, San Diego

Forty-----dollars, and No-----cents,

(\$ 40.00 ), which money is to be paid by me on 4/18/69

to Supplement  
SD 7755-S

for information concerning the case entitled MINUTEMAN ORGANIZATION; IS - MM

US - RM; BPP - RM

Services: \$ 29.00

Federal Income Tax Withheld \$ \_\_\_\_\_

Expenses \$ 11.00

Signed: Steven L. Christensen  
Special Agent

Authority (date) Bulet 12/6/68

Period Covered by Payment 3/16-31/69

Authorization Checked Mel

Check Number 14908

Receipts Received 4/18/69 (4/25/69)

Voucher Prepared 4/28/69 Item 5

Date of Actual Payment 4/18/69

By whom SA S. L. CHRISTENSEN

Informant's File No. 134-914

Approved Σ  
SAC

170-286-13  
134-914-13  
SEARCHED \_\_\_\_\_ INDEXED \_\_\_\_\_  
SERIALIZED J FILED J  
APR 23 1969  
FBI - SAN DIEGO

CITY San Diego, California

DATE March 28, 1969

Request of Special Agent in Charge, FBI, San Diego, California

Forty-eight dollars, and no cents,

(\$ 48.00), which money is to be paid by me on March 28, 1969

to informant  
SP 1155-S

for information concerning the case entitled Minuteman Organization; Black

Panther Party; New Left Movement

Services: \$ 36.00 Federal Income Tax Withheld \$ \_\_\_\_\_

Expenses \$ 12.00

Signed: Steven L. Christensen  
Special Agent

Authority (date) Bulet 12/6/68

Period Covered by Payment 3/1 - 3/15/69

Authorization Checked Pub

Check Number 14823

Receipts Received 3/28/69 (4/1/69)

Voucher Prepared 4/14/69 Item 6

Date of Actual Payment 3/28/69

By whom SA STEVEN L. CHRISTENSEN

Informant's File No. 134-914

Approved [Signature]  
SAC

170-256-12A  
134-914-16  
SEARCHED \_\_\_\_\_ INDEXED \_\_\_\_\_  
SERIALIZED \_\_\_\_\_ FILED \_\_\_\_\_  
APR 14 1969  
FBI - SAN DIEGO

UNITED STATES GOVERNMENT

# Memorandum

TO : SAC San Diego (134-914)

DATE: 4-4-69

FROM : SA Steven L. Christensen

CI  SI  R (Prob)

PCI  PSI  R

SUBJECT: informant  
150 1155-5

Dates of Contact	
3/10/69; 3/12/69; 3/14/69; 3/28/69; 4/2/69	
Titles and File #s on which contacted	
Minkman Organization	100-124401
BPP	100-13978
New Left	100-14273

Purpose and results of contact

- NEGATIVE
- POSITIVE
- STATISTIC

"C" Memos prepared.

170-256-12

Informant certified that he has furnished all information obtained by him since last contact.

Rating

Excellent

Coverage

Minkman, New Left & related Security Matters

SEARCHED	INDEXED
SERIALIZED	FILED
APR 11 1969	
FBI - SAN DIEGO	

CITY San Diego, California

DATE March 12, 1969

Request of Special Agent in Charge, FBI, San Diego, California

Fifty--- dollars, and no cents,

(\$ 50.00), which money is to be paid by me on March 12, 1969

to in payment  
SD/L155 - S

for information concerning the case entitled Minutemen Organization; IS - MM.

Black Panther Party; RM - BPP. ROBERT BOLIVAR DE PUGH; BR.

Services: \$ 37.00 Federal Income Tax Withheld \$ 0.00

Expenses \$ 13.00

Signed: Steven L. Christensen  
Special Agent

Authority (date) Bulet 12/6/68

Period Covered by Payment 2/11  
2/13 - 2/13/69

Authorization Checked Sub

Check Number 14758

Receipts Received 3/12/69 (3/13/69)

Voucher Prepared 3/18/69 Item 6

Date of Actual Payment 3/12/69

By whom SA STEVEN L. CHRISTENSEN

Informant's File No. 134-914

Approved 83  
SAC

770-286-10  
134-914-10  
SEARCHED \_\_\_\_\_ INDEXED \_\_\_\_\_  
SERIALIZED \_\_\_\_\_ FILED \_\_\_\_\_  
MAR 13 1969  
FBI - SAN DIEGO

CITY San Diego, California

DATE February 13, 1969

Request of Special Agent in Charge, FBI, San Diego, California

Fifty dollars, and no cents,

(\$ 50.00), which money is to be paid by me on February 13/1969

to informant  
SD 1155-S

for information concerning the case entitled Minutemen Organization; IS - MM

Services: \$ 35.00 Federal Income Tax Withheld \$ \_\_\_\_\_

Expenses \$ 15.00

Signed: Steven L. Christensen  
Special Agent

Authority (date) Bulet 12-6-68

Period Covered by Payment 1/1-14/69

Authorization Checked Sub

Check Number 14670

Receipts Received 2-13-69 (2-18-69)

Voucher Prepared 2-19-69 Item 11

Date of Actual Payment 2-13-69

By whom SA Christensen

Informant's File No. 134-914

Approved [Signature]  
SAC

170-256-9A  
134-914-9A  
SEARCHED \_\_\_\_\_ INDEXED \_\_\_\_\_  
SERIALIZED \_\_\_\_\_ FILED \_\_\_\_\_  
FEB 19 1969  
FBI - SAN DIEGO

UNITED STATES GOVERNMENT

# Memorandum

TO : SAC. *San Diego (134-914)*

DATE: *2-14-69*

FROM : SA *Steven L. Christensen*

CI  SI  R (Prob)

PCI  PSI  R

SUBJECT: *Informant*  
*SD 1155-5*

Dates of Contact	
<i>1/14/69, 1/15/69, 1/24/69, 1/31/69, 2/13/69</i>	
Titles and File #s on which contacted	
<i>Minute man Organization</i>	<i>100-12461</i>
<i>US Organization</i>	<i>157-328</i>
<i>DeRugh BR</i>	<i>91-3149</i>

Purpose and results of contact

NEGATIVE  
 POSITIVE  
 STATISTIC

*"C" memos prepared*

*170-286-9*

<input checked="" type="checkbox"/> Informant certified that he has furnished all information obtained by him since last contact.	Rating <i>Excellent</i>	Coverage <i>Minuteman, Black &amp; New left militant organizations.</i>
---	----------------------------	--

SEARCHED _____	INDEXED _____
SERIALIZED <i>7</i>	FILED <i>7</i>
FEB 18 1969	
FBI - SAN DIEGO	

*170-286-9*

UNITED STATES GOVERNMENT

# Memorandum

TO : SAC, SAN DIEGO (134-914) (P)

DATE: 1/24/69

FROM : SA C. JORDAN NAYLOR

CI  SI  R (Prob)

PCI  PSI  R

SUBJECT: informant  
SD 1155-S

Dates of Contact	
12/2, 3, 5, 9, 10, 12, 16, 17, 18/68	
Titles and File #s on which contacted	
ROBERT DE PUGH - BANK ROBBERY	91-3149
MINUTEMEN - IS-C	100-12461
BILL CLAY	100-14293
MIKE VEJVODA	100-14302

Purpose and results of contact

NEGATIVE      The informant furnished the residence address of JOHN BUSH at 12320 Parkside, Lakeside, California.

POSITIVE      Informant said BUSH continues to deal in various types of weapons and recently told him he had just seen the largest number of machine guns he had ever seen at one time. BUSH did not indicate where he had seen these machine guns or the conditions under which they had been observed. Informant said he would attempt to determine this information through further contact with BUSH. It is to be noted that BUSH has previously been suspected of dealing in weapons to minority groups and BUSH's wife was observed at a CLEAVER rally in San Diego recently, when she was wearing a "Free Hughey" button. Informant advised he has discussed BUSH's activities with BILL CLAY and CLAY has indicated he intends to turn BUSH into proper police authorities.

Informant said he, BILL CLAY, and WALT HAYWARD, recently published a one-page edition of a bulletin containing eighteen names, addresses and background information on liberals located in the San Diego area. He said it was the

<input checked="" type="checkbox"/> Informant certified that he has furnished all information obtained by him since last contact.	Rating <b>EXCELLENT</b>	Coverage <b>SECURITY and MINUTEMEN ACTIVITIES</b>
---	----------------------------	--

*[Handwritten Signature]*

SEARCHED _____	INDEXED _____
SERIALIZED <u>2</u>	FILED <u>13</u>
FEB - 3 1969	
FBI - SAN DIEGO	

- ① - 134-914
- 1 - 100-14016
- 1 - 100-14302
- 1 - 134-914 A
- CJN:pgb (6)
- 1 - 91-3149
- 1 - 100-14293
- 1 - 100-461

134-914-8  
170-256-8

intention of the group to distribute these pamphlets to various groups, particularly including liberal organizations so that it would be well known that these individuals were known to right wing groups. Informant said the bulletin bore the name of the "Phantom Militia", and was to be distributed on a completely anonymous basis. About two days after publication of the bulletin and before distribution had taken place, CLAY contacted HAYWARD and others and indicated the paper should not be distributed, although it was noted that one copy had already been distributed to the front door of the Good Morning Teaspoon. Informant subsequently determined that CLAY's reason for removal of these bulletins was that one of the names indicated on the list was known only to CLAY and publication of this man's name and background would have positively identified CLAY as the source of information relative to this individual's activities.

Informant, on 12/6/68, indicated he had attended a meeting of the Lakeside Conservative Council held at the Weslian Church, Lakeside, on River Street, attended by approximately 26 individuals. The film was shown on gun control laws which film was made available by the Patriotic Society. Informant identified some of those present as WALT HAYWARD, BILL CLAY, STAN MC DADE, JERRY GIYER, ROBBIE ROBINSON, and this ROBINSON is employee of the telephone company, and others whose names were unknown to informant. Informant indicated he believes MC DADE is active in the Patriotic Society, and described him as a white male, approximately 45 to 50 years of age, 5' 9", 225 pounds, dark hair, wears a goatee and mustache.

Informant furnished the address of WALTER HAYWARD as 12067 Riverside Drive, Lakeside, California, telephone 448-2954. He indicated that at a meeting on 12/6/68, HAYWARD, CLAY and others present, discussed ways and means of agitating the Peace and Freedom Party and the Black Panther Party to get them to fight among themselves. Informant said that the latest publication of the Patriotic Party had been a survival bulletin which contained direct quotations from Staff Publication.

Informant said that since the gun control law has become so common that numerous individuals have been attempting to obtain and hide as many weapons and as much ammunition as possible. Informant said he had recently determined that JERRY GIYER in addition to possessing many other weapons, has a .50 caliber Colt machine gun, an anti-tank rifle, a line-throwing gun, and an M-14 rifle. Informant advised on 12/9/68, that WALT HAYWARD and BILL CLAY had recently attended a Swap Meet where they sold approximately fifteen dollars of miscellaneous items and intended



SD 134-914

to use the cash raise in a publication not of various bulletins. Informant said that he learned that a Black Panther Party meeting had taken place the previous Friday evening and on notifying WALT HAYWARD of this, HAYWARD made several telephone calls, attempting to agitate the Black Panthers and to create friction between the Panthers and the Peace and Freedom Party.

Informant said LYLE MANNING recently advised that an individual by the name of MARCUS from Phoenix, Arizona, has been in San Diego, and is interested in selling weapons. Informant indicated it appears that MARCUS is well known as a weapons distributor and has been known to sell weapons to the Israeli Government. He indicated MARCUS had a recoilless rifle 106 millimeter, which he was asking \$3000 for. Informant said he learned that MARCUS was willing to stash a large number of weapons in a cache in the San Diego area, if right wingers in this area could prove to him that there were a sufficient number of dangerous left wingers to create a need for such a weapons supply. MANNING and FRANK YODUS, the local area representative for Liberty Arms, co-owners of the Hanging Tree Swap Shop, continue in business. Informant said he does not know the extent of their success in this new business as yet. MARCUS was further described as a wholesale meat packer and an owner of at least one department store in the Phoenix, Arizona area.

Informant said MIKE VEJVODA has someone who is assisting him financially in printing numerous handbills which bills are being passed out in left wing neighborhoods in an attempt to agitate and create disturbances. VEJVODA is apparently very interested in making an example of some left winger and has indicated he plans to burn someone's house down or possibly take some individual out into the desert to kill them to make an example out of them. Informant said he advised BILL CLAY of this information and CLAY told VEJVODA that if he should do such a thing, his life would be taken himself. Informant advised that BETTIE HAUGHTON is completely inactive in Minutemen activities at this time and no information has been received regarding the whereabouts of ROBERT DE PUGH or PEYSON.

UNITED STATES GOVERNMENT

# Memorandum

TO : SAC SAN DIEGO (134-914)

DATE: 1/30/69

FROM : SA STEVEN L. CHRISTENSEN

CI  SI  R (Prob)  
 PCI  PSI  R

SUBJECT: SD 1155-S *W. J. ...*

Dates of Contact	
12/23/68; 1/3/69; 1/7/69; 1/9/69	
Titles and File #s on which contacted	
Minuteman Organization	100-12461
Peace and Freedom Party	100-14061
Robert Bolivar DePugh	91-3149

Purpose and results of contact

NEGATIVE      See Channelizing Memo.  
 POSITIVE  
 STATISTIC

<input checked="" type="checkbox"/> Informant certified that he has furnished all information obtained by him since last contact.	Rating Excellent	Coverage Security
---	---------------------	----------------------

1 - SD 134-914

*134-914-4*

SEARCHED \_\_\_\_\_ INDEXED \_\_\_\_\_  
SERIALIZED \_\_\_\_\_ FILED \_\_\_\_\_  
JAN 30 1969  
FBI - SAN DIEGO

CITY San Diego, California

DATE January 14, 1969

Request of Special Agent in Charge, FBI, San Diego

Fifty dollars, and no cents,

(\$ 50.00 ), which money is to be paid by me on 1/17/69

to ~~informant~~  
SD 1155 - S

for information concerning the case entitled Minutemen, SM - M; Black Panther Party,  
RM - BBP; Peace and Freedom Party, SM - PF

Services: \$ 40.00 Federal Income Tax Withheld \$ \_\_\_\_\_

Expenses \$ 10.00

Signed: Steven L. Christensen  
Special Agent

Authority (date) Bulet 12-6-68

Period Covered by Payment 12/12 - 12/31/68

Authorization Checked ml

Check Number 14557

Receipts Received 1/17/69 (1/17/69)

Voucher Prepared 1/21/69 Item 19

Date of Actual Payment 1/17/69

By whom SA S. CHRISTENSEN

Informant's File No. 134- 914 - 6

Approved [Signature]  
SAC

170-286-6  
134-914-6  
SEARCHED \_\_\_\_\_ INDEXED \_\_\_\_\_  
SERIALIZED 73 FILED P  
JAN 22 1969  
FBI - SAN DIEGO

CITY SAN DIEGO, CALIFORNIA

DATE December 10, 1968

Request of Special Agent in Charge, FBI, SAN DIEGO

FIFTY dollars, and NO cents,

(\$ 50.00), which money is to be paid by me on 12/12/68

to ~~USD 1155~~

for information concerning the case entitled MINUTEMEN IS-C (100-12461)

ROBERT DE PUGH Etal - BR (91-3149) WILLIAM CHARLES CLAY - SM-MM

(100-14293) LYLE MANNING - SM-MM (100-14299)

STOCKPILING WEAPONS (157-368)

Services: \$ 35.00 Federal Income Tax Withheld \$ \_\_\_\_\_

Expenses \$ 15.00

Signed: J. J. [Signature]  
Special Agent

Authority (date) Bulet 12-6-68

Period Covered by Payment 12/1/68 - 12/11/68

Authorization Checked [Signature]

Check Number 14429

Receipts Received 12/13/68 (12/13/68)

Voucher Prepared 1/15/69 Item 6

Date of Actual Payment 12/13/68

By whom SA [Signature]

Informant's File No. 134-914

Approved [Signature]  
SAC

170-286-5  
134-914-5  
SEARCHED \_\_\_\_\_ INDEXED \_\_\_\_\_  
SERIALIZED \_\_\_\_\_ FILED \_\_\_\_\_  
JAN 15 1969  
FBI - SAN DIEGO

UNITED STATES GOVERNMENT

# Memorandum

TO : SA Bone

DATE: 1-13-69

FROM : J. Haylor

SUBJECT: Robert DeRugh (91-3149)

stat -

BK -

OO-KC -

On 12/10/68 SD 1155-C converted to

Sec. Informant. <sup>informant</sup> SD 1155-S now being contacted

by SA Christensen.

Informant contacted Dec. 18, 1968 and Jan. 3, 9, 10, 13

He has no new info re whereabouts of DeRugh or Payson

JH

1-91-3149

1-134-914

170-2864  
134-914-4

SEARCHED	INDEXED
SERIALIZED	FILED
JAN 13 1969	
FBI - SAN DIEGO	

1/18

UNITED STATES GOVERNMENT

# Memorandum

TO : SAC , SAN DIEGO (137-1643) (P)

DATE: 12/11/68

FROM : SA C. JORDAN NAYLOR

- CI  SI  R (Prob)
- PCI  PSI  R
- 

SUBJECT: informant  
SD 1155-S

Dates of Contact 10/31, 11/8, 12, 18, 21, 22/ 1968

Titles and File #s on which contacted	
ROBERT D. PUGH - BANK ROBBERY	91-3149
MINUTEMEN IS - C	100-12461
LYLE WINNING	100-14299
STOCKPILING WEAPONS	157-368

Purpose and results of contact

- NEGATIVE
- POSITIVE
- STATISTIC

The following information is being set out under both file numbers 134-New and 137-1643 inasmuch as the Agent has not yet been advised as to whether a new 134 case will be opened in connection with this matter.

Subject furnished a copy of the Minutemen Bulletin dated October 19, 1968 which he advised he had just received in the mail. He noted there was no return address on the envelope and the Post Office date stamp reflected the letter was mailed at San Diego, California. Informant is in continuing contact with BILL CLAY and on October 30, 1968 spent the evening with CLAY and his wife, WALTER HAYWARD and wife at the CLAY residence where they spent the entire evening working on Minutemen records and files. Informant reported discussion at that time regarding possible harassment of all left-wing groups and the selection of specific targets among left-wingers

<input checked="" type="checkbox"/> Informant certified that he has furnished all information obtained by him since last contact.	Rating	Coverage								
	EXCELLENT	SECURITY AND MINUTEMEN ACTIVITIES								
<table border="1"> <tr> <td>SEARCHED</td> <td>INDEXED</td> </tr> <tr> <td>SERIALIZED</td> <td>FILED</td> </tr> <tr> <td colspan="2">DEC 13 1968</td> </tr> <tr> <td colspan="2">FBI - SAN DIEGO</td> </tr> </table>		SEARCHED	INDEXED	SERIALIZED	FILED	DEC 13 1968		FBI - SAN DIEGO		137-1643-3 170-256-3
SEARCHED	INDEXED									
SERIALIZED	FILED									
DEC 13 1968										
FBI - SAN DIEGO										

- 1 - ~~137-1643~~ 1 - 91-3149 1 - 157-368 1 - 100-14016
- 1 - 134-New 1 - 100-13978 1 - 100-14061 1 - 100-12461
- 1 - 100-14296 1 - 100-14297 1 - 100-14299 1 - 100-14301

by Minutemen. They also discussed the possibility of obtaining publicity for Minutemen Front Groups in an effort to build up the morale of Minutemen. The group discussed the organization of a phantom militia to be established as a front for the Minutemen and it was indicated that such names as "The Fox", "Secret American Militia", "Blue Ox Society", and "Swamp Fox" were considered as names for this phantom militia. Informant said the purpose for this phantom militia would be to write letters and conduct other business in an anonymous fashion to harass various individuals and organizations without the identity of the Minutemen being disclosed. Informant said that when CLAY learned he had received a bulletin in the mail he (CLAY) told informant not to discuss the details of the bulletin with anyone. Informant identified WALTER HAYWARD as a white male, age approximately 35 years, height 6' 3", weight 260 pounds, has full beard approximately 1½ inches in length, dark hair, and usually wears a cowboy hat. He has served with U. S. Rangers in Korea and his wife is believed to be a German citizen.

Informant discussed the possibility of an individual identified as MIKE O'HAYER, age about 30, a taxidermist located on Fletcher Parkway, as a possible source of having material printed such as the Minutemen Bulletin. Informant said he is aware that O'HAYER has access to a printing press and believes that he operates the printing press for the Patriotic Society in San Diego. Printing equipment includes offset and linotype machines.

On November 8, 1968, informant advised BETTY HOUGHTON is attempting to sell two printing presses which she has in her possession at an unknown location. Informant said she is attempting to sell these to the editor of the Morning Teaspoon. He said he believes BETTY has recently had a partial nervous breakdown. BETTY has a house guest, FRED HAWES, San Diego 100-14298, who is believed presently separated from his wife who resides in Washington state. Informant said he believes HAWES is paying rent to BETTY HOUGHTON.

Informant said the Peace and Freedom Party has a message information center established at some unknown location and advised that the Minutemen have been using this

message center to relay messages to each other. This phone number used in this connection is San Diego 232-6621. Informant said Peace and Freedom Party Headquarters has made space available to individuals who are organizing themselves under the name of "Friends of the Panthers". He was unable to furnish names of any specific individuals involved in this activity but indicated that the group will possibly use Peace and Freedom Party Headquarters for their activities.

On November 12, 1968, informant advised that recent discussion with BILL CLAY indicated a push toward the phantom militia considering publication of black power propaganda to stir up local white groups. He said the militia will come out with extreme suggestions directed against such people as the John Birch Society and others in an effort to cause right wingers to become indignant against black organizations.

Informant said that the San Diego Mining Association holds periodic meetings at Balboa Park. PAUL RUPLINGER has been invited to speak at the next meeting on November 18, 1968 by WALT HAYWARD, President of the Mining Association.

Informant said the Peace and Freedom Party is making plans to establish a GI Coffee House in San Diego to be used as a front for draft resisters groups and to push anti-war propaganda. He advised that War Resisters League was to meet on November 14, 1968 in front of the Federal Building for a demonstration. (Local authorities notified).

Informant said the local Peace and Freedom Party Message Center had recently been advertising for help and he believed that MIKE VEJVODA was going to volunteer for work to learn the activities of the group. He furnished VEJVODA's telephone number as 449-0136 presently believed to reside in Lakeside or El Cajon. Informant said that he has recently met a DAVE STAFFORD connected with B. C. Enterprises who plans to establish a colony in British Columbia in the near future. He said he feels STAFFORD is



SD 137-1643

possibly a con artist and will attempt to develop more information about him.

On November 18, 1968, informant furnished DAVE STAFFORD's telephone as 269-2638. He said he has learned STAFFORD reportedly has served time in a federal penitentiary on a weapons charge and is believed to be from the state of Indiana. STAFFORD has interested HOWARD GREENLEAF in his project and a Mr. BAKER, identified as a carpenter in the El Cajon area. The group is going to buy a boat, and a 197 foot gold digging dredge for \$15,000.00 which ship is presently located docked on the bay at San Diego. The ship has sleeping quarters for approximately 30 people. STAFFORD is reportedly selling shares to raise \$500,000.00 in connection with taking a group of about 300 people to British Columbia.

DAVE STAFFORD is described as a white male, age 35 to 40 years, height 5' 10", weight 210 pounds, resides with wife and several children on Darnell Street, near Home Avenue and Highway 94.

On November 21, 1968, informant advised he had been contacted at his residence by JERRY LYNN DAVIS, also known as SAM DAVIS, who indicated he had access to several high explosives and wanted to sell some of these items to informant. DAVIS indicated to informant he had the following items available: One pound charges of TNT at \$2.95 each, One third pound charges TNT \$1.50, blasting caps \$8.00 per hundred, fuse \$2.50 a hundred foot, electric blasting caps no price quoted, carbine ammunition in sealed metal containers with 800 rounds to the container no price indicated, four to ten thousand rounds 9 millimeter shells, three hundred rounds armour piercing shells, fragmentation hand grenades at \$10.00 each. DAVIS advised he was going to give explosives demonstrations in an undisclosed place in the desert in the near future and invited informant to participate. No date yet set. Informant feels he was contacted by DAVIS through DAVIS' association with BILL CLAY. DAVIS indicated that he and his group, not further identified, have been working in the back country and have buried items of ammunition, arms, and food placed at distances of one day march intervals throughout the desert from California to Arizona. Informant

said he feels certain that all sources of material including the ammunition and explosives identified above are obtained by DAVIS through some contact with military sources.

On November 22, 1968, informant advised that he had been recontacted by SAM DAVIS and had placed an order for some one pound and one third pound charges of TNT. He said DAVIS told him that the one pound charges are shaped in such a way that they are capable of cutting a hole through one inch of solid steel. Informant said he also attempted to purchase some of the ammunition offered by DAVIS, however, DAVIS advised that he had already disposed of most of it and would have to wait till he obtained more. Informant will furnish the material purchased by him in an effort to determine origin of these materials and to determine if they are government property.

Informant said he has been invited to attend a meeting of the B. C. Adventure Corporation this coming Sunday night, November 24, 1968, at 7:30 P.M. at the home Dr. and Mrs. CRISCOLA (phonetic) who reside in La Jolla, California. This meeting is to be conducted by DAVE STAFFORD and the group will discuss plans for colonization in British Columbia at a remote area where the group can be protected from communist and other organizations attempting to take over the world. Informant advised that he had been on the dredge barge which is being purchased by the group and stated there is a considerable amount of superstructure on this barge which will have to be removed before it could serve any practical purpose for the group. Informant said he had been to STAFFORD's home and was shown a 44 caliber magnum ruger-blackhawk revolver and two or three rifles which STAFFORD has in his home. STAFFORD drives a 1966 cream colored Chrysler.

Informant said he has recently met a BOB KLEINSCHMIDT (phonetic) described as a white male, age 45, height 5' 8", weight 140 pounds with black hair who resides somewhere in El Cajon. He met this individual at the Mining Council Meeting on November 18, 1968 at Balboa Park and is a close buddy of WALTER HAYWARD's. He said KLEINSCHMIDT works for the Mt. Miguel Hospital District, drives a Ford Bronco and

SD 137-1643

spends a lot of time in the desert prospecting, etc. Informant said there were about 36 people present at the Mining Council Meeting and that PAUL RUPLINGER gave a survival lecture on edible plants to be found in the desert. Informant identified WILLIAM CLAY, MIKE VEJVODA, and BILL HOOVER, a retired military man from Lakeside, as people whom he knew at the lecture.

Informant said LYLE MANNING and FRANK YODUS are planning to open up a store on University Avenue between Vandyke and 42nd or 43rd Street which will be a swap shop selling guns, ammunition, and other items. The store is to be identified with the name of Hanging Tree Swap Shop. Informant said YODUS is believed to be retired from the Navy and previously traveled with informant and MANNING to a gun show in Yuma, Arizona, recently. YODUS is described as a white male with a small build, age 45, height 5' 8", light complexion, believed to be the local franchised dealer for Liberty Arms Company.

Informant said he has learned that HAYWARD resides at Riverview Street in Lakeside, California, and has a mimeograph machine located in his bedroom. He was not able to furnish the specific address.

Informant advised he has no certain knowledge of current income for BETTY HOUGHTON, but believes she is receiving financial assistance from TROY HOUGHTON's mother. It is also believed she continues to receive some contributions from Minutemen regarding sales of Minutemen literature and income from FRED HAWES, a boarder at her home. Informant said he has no information regarding any credit, bank, or charge accounts for BETTY HOUGHTON.

The name of J. D. BENNETT is not familiar to informant and he knows no one who has attended the National Convocation at Tuscaloosa, Alabama, during October, 1968.

Date 6/30/72

*informant*  
SD 1155-E  
*informant*  
SD 1155-E

(170-286)

Title and Character of Case

SD 1155-E (170-286)

Date Property Acquired	Source From Which Property Acquired
6/30/72	SD 1155-E

Location of Property or Bulky Exhibit	Reason for Retention of Property and Efforts Made to Dispose of Same
Firearms vault	Retain temporarily until disposition decided upon.

Description of Property or Exhibit and Identity of Agent Submitting Same

Submitted by SA EARL M. PETERSEN

- 1 - Browning Machine Gun, Caliber 50M2, US No. 32846 Mfg by Colts Patent Firearms Mfg. Co., Hartford, Conn. (This weapon completely in a disassembled condition. Barrel has been cut off by welding torch. Not in working condition)
- 1 .38 caliber silencer no brand name but with Pat. Pending and number 96 stamped on it. Blued steel.
- 1 Sawed off shotgun barrel and stock (also sawed off) from Sears Roebuck model ~~100~~ 100.100 shotgun. No serial number. Barrel 13 1/2 inches long.
- 2 Rifle grenade launchers. No identifying marks.

*Sent to Bureau by RA Express 5/3/73 for destruction*  
*WFB see letter dated 4/30/73 Serial 141*

SEMIANNUAL INVENTORY CERTIFICATION TO JUSTIFY RETENTION OF PROPERTY (Initial and Date)

Field File # 170-286 1 B 1

SEARCHED	INDEXED
SERIALIZED	FILED
JUN 30 1972	
FBI - SAN B	

SSC Request 1/20/76  
Item 2 (Re: Howard Berry Godfrey)  
Volume I

Retain

Note  
Pass to any delivery, <sup>return</sup>  
will require Property & <sup>return</sup>  
Security Stamps. <sup>return</sup>

*[Handwritten signature]*

UNITED STATES GOVERNMENT

# Memorandum

TO : DIRECTOR, FBI

DATE: 8/10/67

FROM : SAC, SAN DIEGO (137-1643) (P)

SUBJECT: HOWARD BARRY GODFREY

CONF. INFT. SD 1155-C

GODFREY has furnished valuable information in the past and is being designated a Symbol Number Informant of the San Diego Office. The following information is submitted pursuant to Bureau instructions:

I. INFORMANT'S NAME AND ALL ALIASES

HOWARD BARRY GODFREY

II. SYMBOL NUMBER ASSIGNED

SD 1155-C

III. ADDRESS AT WHICH CONTACTED

Informant is contacted in the downtown area of San Diego in the vicinity of Tenth and C Street, San Diego, California.

IV. RESIDENCE ADDRESS

4582 Maple Street  
La Mesa, California

V. DESCRIPTION

Race	White
Sex	Male
Date of Birth	7/1/43
Place of Birth	Portsmouth, England
Height	5' 10"
Weight	160 pounds
Hair	Brown

② - Bureau (REGISTERED MAIL)  
2 - San Diego

CJN:cav  
(4)

62 AUG 22 1967

Rec'd CI Unit  
10/A

16 AUG 14 1967

~~INP SEC~~  
~~SUPV CONTROL~~

SD 137-1643

Build	Medium
Marital Status	Married
Social Security Number	JFK Act 6 (3)

VI. DATE DESIGNATED INFORMANT

August 10, 1967

VII. ESTIMATE OF RELIABILITY

As far as has been determined through association in the past, this informant has not furnished any false information.

VIII. EMPLOYMENT

Informant is currently employed at the Pacific Telephone and Telegraph Company with offices located at Ninth and C Street, San Diego, California. A review of his employment record at the Telephone Company on 5/10/67 reflected no derogatory information. His present duties include the testing of various equipment used by the Telephone Company in the building located at Ninth and C Street.

IX. PAST ACTIVITIES

This informant is not known to have any criminal record nor to have been involved in any criminal activities in the past.

X. IDENTIFICATION RECORD

Identification Record request submitted 3/24/67 was returned 3/27/67 marked "Unable to identify in Criminal Files." Identification Record request submitted 5/9/67 was returned 5/11/67 marked "Unable to identify in Civil File or Criminal Files."

XI. CRIMINAL ASSOCIATES

Informant has been a gun hobbyist all of his life and was also trained in the use of explosives while serving in the United States Army from 1/18/62 to 1/17/63. Because of this background he has a thorough knowledge of firearms, ammunition and various explosive devices. Although he does not have any close associates who would be considered to be known criminals, he maintains acquaintance with numerous individuals who own and operate gun stores and also other people who are interested in buying and selling firearms and military type equipment. His interest and associations have put him into contact with numerous individuals of possible interest to this Bureau both because of possible theft of government property and also due to the interests of various militant and subversive groups who have an interest in obtaining firearms and explosives.

XII. INFORMATION FURNISHED IN THE PAST

1. PATRIOTIC PARTY  
INTERNAL SECURITY - C

The informant was requested to attend a public meeting on 2/24/67 at the House of Hospitality, Balboa Park, San Diego, California. Approximately 100 adults attended this meeting. HOWARD F. CLARK, 1086 Sixth Street, Ramona, California, employed at Convair, San Diego, California and also Treasurer of the International Toastmasters, District #5, conducted this public meeting at which ROBERT B. DE PUGH of Norborne, Missouri, National Co-ordinator of the "Minutemen" was the principle speaker. DE PUGH discussed the aims of the Patriotic Party following which elections were held and informant reported that HOWARD F. CLARK was elected Chairman of the Patriotic Party with a Mr. BRINKER as Vice-Chairman, Mrs. BRINKER Secretary, and GARNER P. DICUS, aka Jerry Dicus, Treasurer. The informant furnished the identity and background information regarding numerous individuals present in attendance at this meeting.



2. MINUTEMEN - INFORMATION CONCERNING  
INTERNAL SECURITY

Informant advised that he attended a meeting on 3/4/67 at the residence of VICTOR WALTON, 5549 Kiowa Drive, La Mesa, California at which 43 people were present. The main speaker of the evening was BERTRAND L. COMPARET, a local San Diego attorney with office at 525 C Street and residence at 4930 Mansfield, San Diego, California. COMPARET was identified by the informant as author of the book "Your Heritage" and commentator on radio programs for stations XERB, KTYM, and KBIF. The informant reported the theme of COMPARET's talk to be on the history of Isreal and of an anti-Semetic nature. Numerous individuals present were identified by informant including TROY HAUGHTON.

Through subsequent association of the informant with TROY HAUGHTON, Western Regional Co-ordinator of the Minutemen, who resides in San Diego, California, informant learned that HAUGHTON is anxious to purchase automatic weapons of all types. HAUGHTON displayed to informant a new 308 German rifle and indicated he was extremely interested in obtaining Browning automatic rifles and any sub-machine guns that might be available. HAUGHTON indicated he had been purchasing materials including guns and ammunition from GERALD T. GIYER, who resides at 9467 Riverview, Lakeside, California. Informant identified GIYER as a well known amateur gun collector in the San Diego area.

3. UNKNOWN SUBJECT;  
THEFT OF AUTOMATIC WEAPONS,  
MADISON HIGH SCHOOL, ROTC,  
SAN DIEGO, CALIFORNIA  
2/24 - 27/67  
TGP

During February, 1967, two Browning automatic rifles, one .30 caliber machine gun and 5,000 rounds of .22 caliber ammunition were stolen from

SD 137-1643

the office of the ROTC, Madison High School, San Diego, California. The above guns were subsequently discovered to be buried in a remote area east of El Cajon, California and were recovered and returned to the school. Investigation to locate the ammunition was conducted. On 4/13/67, informant advised that he had observed GERALD GIYER selling large quantities of .22 caliber ammunition at a swap meet at a drive-in theater in El Cajon, California during a recent weekend. Investigation was conducted to determine if this ammunition was identical with that stolen from the ROTC office; however, no conclusion could be reached inasmuch as the ammunition could not be identified.

Informant has furnished numerous copies of articles and material obtained by him from the residence of TROY HAUGHTON. The material deals primarily with instructions regarding military type operations as well as considerable anti-Semetic literature.

On 7/27/67, informant reported that he had accompanied BILL CLAY, active in Minutemen activities, on the previous weekend when CLAY traveled throughout the remote areas east of San Diego, California on various Indian Reservations during which time CLAY was attempting to discover abandoned mines and any other appropriate areas deemed to be useful in storing arms caches. Informant reported that during this time while with CLAY, CLAY referred to the theft of Browning automatic rifles, a machine gun and ammunition stolen from the ROTC at Madison High School during February, 1967. CLAY said that if these weapons had been hidden better they would never have been found by Police Officers. Informant reported that CLAY did not specifically say he knew who had been responsible for the theft of these weapons and ammunition but did give the general impression that he had such knowledge.

4. "LOVE IN",  
RAMONA OAKS RANCH,  
RAMONA, CALIFORNIA  
5/20 - 21/67  
INTERNAL SECURITY

On 5/19/67, informant advised that several thousand "hippies" planned to congregate at Ramona, California during 5/20 - 21/67. Informant reported that the "Minutemen" planned to create trouble among the "hippies" so that as a result of this, the "hippies" would try to take over the town of Ramona, California.

Informant reported that the idea behind the "Minutemen" participating in the activity was so the people of Ramona would become alert to the fact that "it can happen in their town".

Informant advised that the "Minutemen" planned to spread sugar cubes throughout the town of Ramona to give the impression that the cubes contained LSD. They intended to change highway signs and road markers to create confusion and to direct arriving "hippies" to local Indian Reservations thus creating the possibility of clashes between local Indians and the "hippie groups". Informant said the "Minutemen" planned to collect bags of dog waste material and distribute this throughout the city of Ramona so that the "hippies" would be blamed for this act. All information furnished by informant was furnished to local law enforcement agencies. On the first day of the scheduled "love in" the San Diego County Sheriff's Office and California Highway Patrol established a command post in the vicinity of Ramona Oaks Ranch, Ramona, California following which ten arrests were made of adults and juveniles for possession of marijuana and LSD. A road block was set up in the vicinity by the California Highway Patrol to check on the safety of vehicles traveling in the vicinity. It was reported that this apparently discouraged a number of individuals from attending the "love in" at Ramona Oaks Ranch as the attendance did not exceed more than 300 or 400 participants. The informant reported following this activity that the members of the "Minutemen" group who attempted to cause trouble in the area were dissuaded because of the law enforcement officers being present in the community.

SD 137-1643

XIII. CAPABILITY OF BEING USED OUTSIDE THE SAN DIEGO DIVISION

Due to the informant's residence in La Mesa, California and full time employment at San Diego, California, he has indicated he does not desire to receive assignments outside of this local area. He has indicated, however, that he would make his services available for any important matters which might take place in other areas.

XIV. INFORMATION REFLECTING INFORMANT TO BE EMOTIONALLY UNSTABLE, UNRELIABLE, OR TO HAVE FURNISHED FALSE INFORMATION

No information has been developed during contacts with informant to date which indicate the informant is unstable or unreliable. No information has been developed that would indicate he has furnished any false information.

Inasmuch as the informant has furnished information of both a security and criminal nature, he will be operated as a Criminal Informant, however, security type information will continue to be received from him.



UNITED STATES DEPARTMENT OF JUSTICE

FEDERAL BUREAU OF INVESTIGATION

San Diego, California  
December 15, 1967

In Reply, Please Refer to  
File No. SD 137-1643

SYMBOL NUMBER:

CONF. INFO

SD 1155-C

Informant

BUREAU FILE NUMBER:

137-17222

EMPLOYMENT:

Informant is currently employed at the Pacific Telephone and Telegraph Company with offices located at Ninth and C Streets, San Diego, California. His present duties include testing of various equipment used by the telephone company in the building located at Ninth and C Streets.

DATES OF CONTACT:

CI designated informant on 8/10/67.  
8/11, 23, 24/67;  
9/1, 11, 14, 22, 26/67;  
10/23, 26, 30/67;  
11/3, 6, 7, 27, 29, 30/67;  
12/1/67.

OUTCOME OF CASES NOT PREVIOUSLY COMPLETED:

None.

INFORMATION FURNISHED:

Informant was designated a CI on 8/10/67. A summary of information furnished was sent to the Bureau by letter dated 8/10/67 and is not being repeated in this summary.

MINUTEMEN - INFORMATION CONCERNING INTERNAL SECURITY, SD File 100-12461

137-17222-100  
DEC 19 1967

Informant has been furnishing information regarding the activities of Minutemen groups in the San Diego area on a continuing basis for several months. He has been developed by the Minutemen because of his extensive knowledge of firearms and use of explosives. Since August 24, 1967, he has been

Handwritten signatures and initials at the bottom of the page, including "J. L. Maguire" and "J. Maguire".

SD 137-1643

asked on a continuing basis by BETTY HAUGHTON, present leader of Minutemen activities in the San Diego area to make frequent visits to the Peace Center, operated by the Peace and Freedom Party. Purpose of the informant's assignment has been to identify individuals participating in activities at the Peace Center and obtain all available literature as well as to secure keys to the office and any files, which keys can be used by the Minutemen to obtain mailing lists and other confidential information. In addition to informant's assignments in attending meetings and other activities for the Minutemen, he is frequently contacted by individuals seeking assistance in obtaining guns, ammunition, and explosives. He has thus been able to identify individuals interested in obtaining weapons and explosives.

Informant furnishes literature distributed through local Minutemen sources and has kept this office advised of the activities of BETTY HAUGHTON regarding actions taken by her in an effort to locate her husband, TROY HAUGHTON, who is a National Minuteman leader and who disappeared several months ago.

During the visit of former Alabama Governor GEORGE C. WALLACE, who spoke at Russ Auditorium, San Diego, California, the night of 11/2/67, informant attended this meeting and furnished information regarding the identities of several persons present as well as reporting that local Minutemen were utilized during this meeting as door keepers and ushers.

PEACE AND FREEDOM PARTY  
INTERNAL SECURITY  
SD File 100-14061

On 10/26/67, informant advised that at the request of BETTY HAUGHTON, in behalf of the local San Diego Minutemen organization, he has been visiting the new office of the Peace and Freedom Party located at 5728 El Cajon Boulevard, San Diego, California. The purpose of informant's contacts at this Center has been to identify members and people interested in the activities of the Peace and Freedom Party as well as to obtain mailing lists and obtain any other information of value regarding activities occurring there. Informant stated that at the request of Dr. FRANCIS HALPERN,

SD 137-1643

Chairman of the Peace and Freedom Party, who is also a professor at the University of California, San Diego, California, informant registered as a member of the Peace and Freedom Party on Certificate Number 524401 while visiting the Peace Center on 10/21/67 and identified the registrar as FRITJOF P. THYGESON. Informant has participated in numerous activities at the Peace Center and has furnished information including mailing lists and addresses of members of that Party to the San Diego Office. He has also furnished information regarding activities of the local Minutemen to cause disturbances and create a continuing harrassment of the Peace and Freedom Party activities.

GILBERT O. MC GILL  
POSSIBLE THEFT OF GOVERNMENT  
PROPERTY, SD File 52-4723

On 9/1/67, informant identified GILBERT O. MC GILL as an individual known to be dealing in guns and ammunition on a confidential basis with anyone having necessary cash. MC GILL was identified as an employee of the Pacific Telephone Company at San Diego, California, and offered to assist informant in obtaining 10,000 rounds of 30.06 ammunition for informant and indicated this could be obtained by MC GILL in sealed, water-tight metal containers in clips ready for firing. MC GILL indicated to informant that he could also assist him in obtaining hand grenades. MC GILL indicated to informant it was possible for him to obtain the ammunition in sealed metal cartons only when large Navy ships were in the San Diego Bay for repair. He indicated that he could get big lots of ammunition only at that time, but could obtain regular cartons at any time they were desired. A background investigation was conducted of MC GILL, however no prosecution is pending at this time.

POLICE COOPERATION  
SAN DIEGO DIVISION

On 11/27/67, informant advised that during the Thanksgiving holidays he visited the Peace and Freedom Party Headquarters on El Cajon Boulevard, San Diego, California on 11/23/67. He reported that during this visit, it was learned that an alleged burglary had occurred at the premises and that a loss of two typewriters had occurred in addition to having the telephone lines of the office pulled from their

SD 137-1643

installations. Informant advised that the theft had been reported to the San Diego Police Department by JOHN SCHOPP, Executive Board Member of the Peace and Freedom Party on 11/23/67. Informant further advised that early in the morning on 11/23/67, he had personally observed JOHN SCHOPP to remove two typewriters from the Peace and Freedom Party Headquarters Building and place these typewriters in his automobile. Informant advised that it was his feelings SCHOPP had taken these typewriters and reported them stolen in order to obtain publicity for the organization. Records of the San Diego Police Department reflect that the Peace and Freedom Party, San Diego, California, reported a burglary of their office on 11/23/67, indicating that two typewriters had been stolen and telephones in the office pulled from their installations. Investigation conducted failed to develop any suspects.

On 11/28/67, Detective PAUL YBARRONDO, Burglary Detail, San Diego Police Department, was advised of the fact that JOHN SCHOPP was a possible suspect in the theft of the typewriters and the Police Department was furnished sufficient detail to enable them to conduct an appropriate investigation in this matter.

On 9/1/67, information was furnished by informant reporting that a bookmaker identified only as "Charlie" was operating from a used clothing store located next to the Villa Inn at 45th and Market Streets, San Diego, California. This information was orally furnished to the San Diego Police Department for appropriate action.

On 12/1/67, informant advised that he had been in contact with LYLE J. MANNING, a local Minuteman member, who had advised him that the Minutemen intended to telephonically report to the San Diego Police Department and other police agencies on that date, that a bomb would be placed at the Village Inn as a protest against the Peace and Freedom Party holding a meeting at the Village Inn. Informant reported that MANNING indicated the Minutemen had no intention of placing any bombs, but that their intention was to make false reports to police and other authorities to create a disturbance. This disturbance was to be created in connection with an activity of the Peace and Freedom Party who had sent out invitations for a dinner to be held at the Vacation Village Hotel at San Diego, California at 7:00 p.m. on 12/1/67 to



SD 137-1643

honor Dr. LINUS PAULING, Nobel Peace Prize Winner and Professor of the University of California at San Diego, California. Informant reported that the Minutemen intended to create a disturbance at this dinner because of PAULING's well known communist background.

On 12/1/67, Inspector EDWARD DE BOLT, Police Department, San Diego, California, advised that the Business Office of the Police Department received an anonymous telephone call that date alleged to be from a member of the Minutemen. The anonymous telephone call reported that someone was going to blow up the Village Inn on the evening of 12/1/67.

Inspector DE BOLT was furnished information concerning the Peace and Freedom Party dinner to honor Dr. LINUS PAULING and Inspector DE BOLT advised that the San Diego Police Department would have the necessary coverage at the Vacation Village Inn in the event a bomb was placed there.

On 12/4/67, Inspector DE BOLT advised that the Police Department had covered the Peace and Freedom Party Affair at the Vacation Village and that no bomb had been placed there.

The above information furnished by this informant has been of considerable value to the San Diego Division and could not have been obtained through other sources.

RECOMMENDATION:

During the inspection of the San Diego Division which occurred in November, 1967, informant was rated as excellent by the Inspector. It is highly recommended that this informant be continued.

STABILITY AND  
RELIABILITY:

There has been no indication of emotional instability on the part of the informant and as far as can be determined, informant has furnished no false information.

SAC, San Diego (137-1643)

1/12/68

Director, <sup>REC-21</sup> FBI (137-17222) - 2

SD 1155-C

*int. sec. inf.*

*C*

Reurlet 1/5/68.

Your request to pay captioned informant at the rate of \$125 per month on a regular basis is not approved. This individual was developed by you on 8/10/67, and since that time has furnished, almost exclusively, security-type information. The Theft of Government Property-type information being furnished, while of a criminal nature, appears to have a direct relationship with the activities of security subjects.

In view of the newness of this informant and the fact that virtually all information being furnished is of a security nature, you should consider redesignating this individual as a security informant in accordance with provisions set forth in Section 107, Manual of Instructions.

Authority is granted, effective with the date of this letter, to pay captioned informant on a strictly C.O.D. basis the sum of up to \$200 in accordance with provisions set forth in Section 106 J2, Manual of Instructions.

- 1 - M. J. Rozamus, 906 9th & D
- 1 - M. F. Row, 6221 IB

MAILED 22  
 JAN 12 1968  
 COMM-FBI

NOTE: Captioned individual was approved as an informant 8/10/67. Since that time all information furnished by him relates to various Internal Security subjects and Internal Security groups under investigation by this Bureau. Authority to make regular payments as a criminal informant should not be approved at this time. It is recommended, however, that a new \$200 SAC authority be approved with payments to be made on a strictly C.O.D. basis.

- Tolson \_\_\_\_\_
- DeLoach \_\_\_\_\_
- Mohr \_\_\_\_\_
- Bishop \_\_\_\_\_
- Casper \_\_\_\_\_
- Callahan \_\_\_\_\_
- Conrad \_\_\_\_\_
- Felt \_\_\_\_\_
- Gale \_\_\_\_\_
- Rosen \_\_\_\_\_
- Sullivan \_\_\_\_\_
- Tavel \_\_\_\_\_
- Trotter \_\_\_\_\_
- Tele. Room \_\_\_\_\_
- Holmes \_\_\_\_\_
- Gandy \_\_\_\_\_

ABF:paf  
(6)

*Walt*  
*ABF*  
*1/12/68*  
*OK*

51 FEB 8 1968

MAIL ROOM  TELETYPE UNIT

UNITED STATES GOVERNMENT

# Memorandum

TO : DIRECTOR, FBI (137-17222)

FROM : SAC, SAN DIEGO (137-1643) (P)

SUBJECT: CONF. INET  
SD 1155-C Informant

DATE: 1/5/68

35

I recommend that authority be granted to pay the above informant up to \$75 per month for services and \$50 per month for expenses for a period of six months on a COD basis or for expenses to be incurred or services rendered in seeking information at our specific request. This authorization is to be effective January 15, 1968, and letters of progress will be submitted quarterly. My letter of June 15, 1968, will contain my recommendation concerning further payments.

In all contacts with this informant to date there has been no indication on the part of the informant of any emotional instability, unreliability, nor has he furnished any false information.

Informant was designated a PCI on February 27, 1967, and converted to a Criminal Informant on August 10, 1967.

### PAYMENTS

Under authority of Section 108J, Number 2, Manual of Instructions, the following amounts have been paid to the informant as indicated:

R

- ③ - Bureau (reg.)
- 1 - San Diego

CJN:ecc  
(4)

Let to SD  
1-12-68  
ABF: Pif

*[Handwritten signatures and initials]*

REC-211

EX-103

137-17222-2

24

15 JAN 16 1968

*[Handwritten signature]*

SD137-1643

<u>Date</u>	<u>Period</u>	<u>Amount Paid</u>
3/15/67	2/27-3/10/67	\$ 50.00
5/3/67	3/11-5/1/67	50.00
5/26/67	5/2-5/25/67	35.00
9/1/67	5/26-8/31/67	40.00
11/3/67	9/1-11/2/67	25.00
		<hr/>
Total Amount Paid		\$ 200.00

INFORMATION FURNISHED

UNSUB;  
THEFT OF AUTOMATIC WEAPONS,  
MADISON HIGH SCHOOL,  
ROTC, SAN DIEGO, CALIFORNIA  
2/24-27/67  
TGP  
SD52-4585

The following theft of two Browning Automatic Rifles, one .30 Caliber Machine Gun and five thousand rounds of .22 Caliber ammunition from Madison High School, San Diego, California, CI developed information that one, GERALD GIYER was selling large amounts of .22 Caliber ammunition at a swap meet at prices below the San Diego market. Investigation was conducted, however it was impossible to identify the ammunition as being that stolen from the High School.

CI developed association with one, BILL CLAY, active in Minutement Activities in the San Diego area and spent several days with CLAY traveling in remote areas of San Diego and on various Indian Reservations during which time CLAY was attempting

SD137-1643

to discover abandoned mines and other appropriate areas deemed useful in storing arms caches. CI reported that during this excursion CLAY referred to theft of the Browning Automatic Rifles and other items stolen from Madison High School. Subsequent investigation conducted in this captioned matter located the Browning Automatic Rifles buried in the remote area which had been previously observed by CLAY.

✓  
7  
F. Schmitt

PATRIOTIC PARTY  
INTERNAL SECURITY -C

(SD-100-13832)

Informant has attended meetings of the Patriotic Party and specifically has identified individuals present at such groups including ROBERT B. DE PUGH of Norborne, Missouri, National Coordinator of the Minutemen, as speaker at one meeting. CI also furnished the identity of officers elected to the Patriotic Party at a meeting which he attended.

MINUTEMEN-  
INFORMATION CONCERNING  
INTERNAL SECURITY  
SD100-12461

CI is a very active member of the Minutemen Organization in San Diego, California, and has furnished complete details of all Minutemen activities in this area. He has been a close associate of TROY HAUGHTON, the West Coast leader of the Minutemen until his disappearance about six months ago. Since that time informant has continued his association with BETTY HAUGHTON, who is active in organizing Minutemen activities throughout Southern California and publishing much material for distribution through Minutemen contacts. CI furnishes copies of literature published by HAUGHTON and also attends numerous functions of the Minutemen as well as other functions through assignments by BETTY HAUGHTON. He has been extensively developed by the Minutemen because of his knowledge of firearms and use of explosives. He has also been assigned to make frequent visits to the Peace Center operated by the Peace and Freedom Party at San Diego, California, and has associated with individuals in that group to identify them and their activities for information of local Minutemen. In addition, he is frequently contacted

SD137-1643

by individuals seeking assistance in obtaining guns, ammunition and explosives. He has thus been able to identify individuals interested in obtaining weapons and explosives. During recent visit of former Alabama Governor GEORGE C. WALLACE, who spoke at Russ Auditorium, San Diego, California, informant attended this meeting and furnished information regarding identities of persons present as well as reporting that local Minutemen were utilized as doorkeepers and ushers.

"LOVE IN"  
RAMONA OAKS RANCH  
RAMONA, CALIFORNIA  
5/20-21/67  
INTERNAL SECURITY  
SD100-12461

CI furnished information regarding the plans of Minutemen to disrupt meeting of several thousand "hippies" to congregate at Ramona, California, during spring of 1967. Information furnished by CI regarding plans and activities at this meeting were furnished to local police agencies and assisted in the prevention of wide spread rioting in the Ramona area.

PEACE AND FREEDOM PARTY  
INTERNAL SECURITY  
SD100-14061

At the request of BETTY HAUGHTON, on behalf of local San Diego Minutemen Organization, CI has frequented the Peace and Freedom Party Headquarters in San Diego for purposes of identifying members and participants in activities there. He has furnished information about the harassment of this group by the local Minutemen and in addition, has obtained literature and mailing lists and other pertinent information for distribution to the Minutemen Organization. CI makes the information available to the San Diego Division before passing on to Minutemen Organization

SD137-1643

GILBERT O. MC GILL  
POSSIBLE THEFT OF GOVERNMENT PROPERTY  
SD52-4723

CI has identified MC GILL as an individual dealing in guns and ammunition in the San Diego area and determined that MC GILL is dealing in large amounts of ammunition and other explosives. MC GILL has attempted to assist CI in obtaining large amounts of ammunition including hand grenades for use by local Minutemen Organizations.

POLICE COOPERATION  
SAN DIEGO DIVISION

CI furnished information reflecting that officers of the Peace and Freedom Party at San Diego, California, had reported theft of two typewriters to the San Diego Police Department from the Peace and Freedom Party Headquarters. CI was present at the Headquarters on the date of this reported theft and personally observed one of the officers take the two typewriters in question from the building and place them in his personal automobile. This information was furnished to the Burglary Detail of the San Diego Police Department and the theft report confirmed. CI furnished the identity of JOHN SCHOPP as the suspect in the theft of these typewriters.

CI furnished information that local Minutemen planned to make threatening phone calls to police departments and other law enforcement agencies in the San Diego area during a meeting honoring LINUS PAULING. PAULING was being honored by the Peace and Freedom Party at San Diego, California, at a meeting held at the Village Inn. CI advised that these threatening phone calls to place bombs at the Village Inn were for the purpose of disrupting the meeting and no actual bombs would be placed. Inspector EDWARD DE BOLT, San Diego Police Department, advised that the Police Department did receive a bomb threat report

SD137-1643

regarding the above meeting and he was advised of appropriate information received from CI. Inspector DE BOLT advised that the Police Department covered the Peace and Freedom Meeting as indicated above and no bomb was placed there.

CI has identified the residence of WILLIAM KITT, 1929 North 33rd Street, San Diego, as a place where LSD and other narcotics are being purchased and resold in the San Diego area. This information has been furnished to the Narcotics Bureau of the San Diego Police Department.

In addition to the above information set out regarding the activities of the CI it is to be noted that he has volunteered the clerical and secretarial assistance of his wife to the Minutemen organization for the purpose of obtaining additional background information for information regarding the Minutemen activities and work being performed at the Minutemen office, the residence of BETTY HAUGHTON.

This CI has enabled the San Diego Division to follow activities of local Minutemen groups and activities of the Peace and Freedom Party to a very extensive degree. This information would not generally be available to any other sources of the San Diego Division and could not be obtained by Special Agents due to the nature of the information.

This CI has demonstrated resourcefulness and ingenuity in obtaining information and has dedicated a great deal of his time to this work for the Bureau. Information furnished by the CI is believed to be of much greater value than the remuneration which he receives.

It is to be noted that a considerable amount of information furnished by the informant is of a security nature. This information is appropriately disseminated and channelized. It is recommended however, that the informant be continued as a Criminal Informant inasmuch as he was originally developed for this purpose and continues to furnish information in the criminal field.





SD 137-1643

contacted him that date advising he could furnish 500 rounds of shot line shells at 4:00 p.m. that date and planned to take this ammunition from the ship. In order not to compromise the informant through an FBI investigation of this matter the above information was furnished to the Security Office of the U. S. Naval Station, at which time it was recommended that a search of all personnel be conducted that day as they were departing the ship for shore leave. CI reported later that same date that he had been contacted by COON, but COON indicated he could not obtain the ammunition from the ship because of increased security measures on board.

On 3/25/68, CI advised that in connection with a nationwide telephone strike under consideration by telephone employees, TERRY FINK, Western Electric Union representative, San Diego, California, had been talking about sabotage to telephone company equipment in order to impress upon the telephone company the need for negotiating with telephone company unions. Specific recommendations were made regarding use of rifles to shoot insulators off of telephone lines in rural areas and also sabotaging telephone lines in the city by cutting lines where possible. It was indicated this tactic was the only means considered feasible to stop telephone transmissions to enforce the demands of union employees. This information was immediately furnished to Special Agent SAM BEASLEY, Security Office, Pacific Telephone Company, San Diego, California.

MINUTEMEN - INTERNAL SECURITY  
INFORMATION CONCERNING  
SD File 100-12461

On a continuing basis the informant has furnished copies of all literature and information printed and published by Minutemen sources in the San Diego area including the initiation of the publication of the periodical "TARGET" published in the San Diego area by BETTY HAUGHTON for distribution to all active Minutemen and super patriots. On 1/3/68, the informant advised that during the appearance of the Moscow Circus at the San Diego International Sports

SD 137-1643

Arena several Minutemen participated in picketing the circus and marched up and down in front of the arena carrying signs and placards. CI furnished the identities of those members of the Minutemen who participated in these activities.

On 4/22/68, CI reported that he, at the request of BILL CLAY, who has taken over active leadership of the Minutemen inasmuch as BETTY HAUGHTON has ceased active leadership of the Minutemen activities, participated in placing several large signs over prominent overpasses spanning freeways in the San Diego area where they would be observed by the morning rush hour traffic on 4/22/68. CI reported the individuals involved in this activity which involved the placing of the above signs constructed by BILL CLAY bearing inscriptions such as, "Communist Traitors Beware". CI reported that the signs were placed in prominent places through the use of two-way radios in vehicles so that the individuals placing the signs could avoid being apprehended.

In addition to the above information, CI has continuously furnished information from Minutemen activities particularly dealing with contemplated destruction or assault which did not in fact take place. It is to be noted that this informant is the only source of information in the San Diego Division actually engaged in Minutemen activities.

MIKE VEJVODA, aka.,  
Paul Anthony;  
BOB JONES;  
POSSIBLE THEFT OF GOVERNMENT PROPERTY  
SD file 52-4918

On 4/15/68, informant advised that MIKE VEJVODA, a young Cuban recently moving to San Diego from the Los Angeles area, has been actively attempting to establish himself in the Minutemen activities in San Diego. VEJVODA was identified by informant as the San Diego Chief Supporter of "Staff" in this area.

VEJVODA was reported by informant to be extremely interested in encouraging accumulation of arms and ammunition

SD 137-1643

by private citizens in the San Diego area. VEJVODA was accompanied by informant to Hawthorne, California to attend a gun show on March 30 - April 1, 1968, at which time informant was introduced by VEJVODA to several acquaintances in the Los Angeles, California area. One such individual was BOB JONES, identified as a member of the 40th Armoured Division National Guard. Informant reported that VEJVODA has been in contact with BOB JONES in a continuing effort to obtain two Browning Automatic Rifles which he plans to have stolen from the 40th Armored Division Armory. This information has been furnished to the Los Angeles Division who in turn has advised appropriate military authorities, in that area.

On 6/5/68, CI furnished the identity of MIKE VEJVODA as a very likely suspect in the shooting of ROBERT KENNEDY in Los Angeles, California on 6/4/68 inasmuch as the physical description of the individual apprehended following the shooting was almost identical to the physical description of MIKE VEJVODA. Informant conducted the subsequent investigation which determined that VEJVODA was in the San Diego area on the morning of 6/5/68 and therefore could not have been the individual in custody in Los Angeles in connection with that assault.

JERRY DICUS  
INTERNAL SECURITY - C  
SD File 100-14017

On 5/3/68 and 5/27/68, informant furnished information relative to the activities of DICUS who has been actively engaged in the past in Minutemen activities and also in attempting to encourage organization of anti-Negro and anti-semitic activities in the San Diego area. Informant has developed information reflecting that DICUS is no longer to be contacted by any members of the Minutemen organization in the San Diego area and reported that DICUS has been having personal problems which caused the separation of he and his

SD 137-1643

wife during recent weeks. Background information regarding DICUS was developed including the location of his mailing address at Post Office Box 3393 Hillcrest Station, San Diego, California.

RECOMMENDATION:

Informant has consistently and conscientiously demonstrated a high degree of intelligence as well as interest in assisting the FBI in the gathering and reporting of information to this office. It is highly recommended that this informant be continued.

STABILITY AND  
RELIABILITY:

There has been no indication of emotional instability on the part of the informant and as far as can be determined, informant has furnished no false or misleading information.

UNITED STATES GOVERNMENT

# Memorandum

TO : DIRECTOR, FBI (62-107261)

DATE: 8/2/68

FROM : SAC, SAN DIEGO (100-12461) (P)

SUBJECT: MINUTEMEN  
IS - MISCELLANEOUS

Re SAC Letter 68-38, dated 7/2/68.

INFORMANT COVERAGE - MINUTEMEN:

I. EXISTING INFORMANTS WHO REPORT EXCLUSIVELY ON MINUTEMEN

None

II. EXISTING INFORMANTS WHO REPORT ON SEVERAL ORGANIZATIONS

CONF. INFT. SD 1155-C, San Diego file 137-1643.  
INFORMANT Bufile 137-17222

Above informant was opened as a PCI in the San Diego Division on 2/27/67, and for a while furnished information relating to theft of firearms. Informant then connected himself with the top echelon of Minutemen members in the San Diego area and has furnished valuable information regarding Minutemen members and the activities of the organization itself in the San Diego area.

Through his connections with the Minutemen he has involved himself in New Left and Black Power activities for the purpose of obtaining intelligence data on these various organizations for the Minutemen. All information derived on these organizations, including Students for a Democratic Society and the Black Panther Group, has been of assistance to the Bureau.

Although above informant has been handled as a criminal informant to date, steps will be taken to convert him to a security informant.

- 2 - Bureau (AM) (REGISTERED)
- 3 - San Diego  
(1 - 137-1643)

AWO:ber

5 AUG 5 1968

*F. J. [unclear]*  
*Ryan [unclear]*  
*De [unclear]*

100-1-1361-11

*Wilson*  
1501

10 AUG 7 1968  
137-17222-5  
NOT RECORDED  
178 AUG 23 1968

ORIGINAL FILED IN

INT/SEC

SD 100-12461

In view of the highly secretive nature of the Minutemen organization, wherein no one member is allowed to know all other members, efforts are being made to develop additional quality informant coverage to insure complete coverage of this organization in the San Diego Division.

The San Diego Division has intensified its investigation into members and suspected Minutemen members for the purpose of determining the total membership in the San Diego area. It is felt that this intensified investigation will also assist in identifying individuals who would be prospects for quality informants.

This program will be closely followed in the San Diego Division.

UNITED STATES GOVERNMENT

# Memorandum

*File*

TO: *Eum* SAC, *San Diego* (Your file \_\_\_\_\_) DATE: *9/23/68*

FROM: *1* Director, FBI (Bufile and Serial *137-17223*)  
Room No. *7507*

Post in file and destroy 0-1  
(For SOG use only)

SUBJECT: *SD 1155-C*  
*11 Form 100*

1. Bufiles indicate this case is delinquent. Give specific reason for delinquency.

airtel  letterhead memo  submitted

2. DATE  report  letter  90-day progress letter  will be submitted \_\_\_\_\_ *R 5/10*

Reporting employee \_\_\_\_\_

3. If valid reason exists for not submitting report at this time, state reason specifically and when report will be submitted \_\_\_\_\_

4. Status of  Appeal  Inquiry  Investigation  Prosecution

airtel  letterhead memo  report  letter  90-day progress letter by \_\_\_\_\_ *CT*

*Serial file 100-12461*

SEARCHED	INDEXED
SERIALIZED	FILED
SEP 23 1968	
FBI - SAN DIEGO	

*File*

(Place reply hereon and return to Bureau. Note receipt and acknowledgment on top serial in case file.)

*(over)*



11/14/68  
5D-7155-C

has just changed employment and his current status undetermined due to change in working schedule and time available to continue in assisting Bureau, If CI able to continue to be active in minute man activities he will be converted to SI.

Since CI is presently in training status until middle of Oct. and schedule unknown until training completed, no change being made at this time and Bu will be advised of any change in status within 45 days -

SEP 30 9 59 AM '68

INCONS OCT 18 1968

1 - Mr. T. P. Druken

SAC, San Diego

12/6/68

Director, FBI (137-17222) 3

SD 1155-S

informant

Reurlet 11/13/68.

Authority is granted to change captioned individual from a criminal to a security informant.

Authority is granted to pay captioned individual an amount up to \$75 per month for services rendered on a c.o.d. basis and up to \$25 per month for expenses actually incurred for a period of six months effective 12/1/68.

Concerning your payments to this informant and all informants, you are reminded that payments must be commensurate with the value of the information received; that payments are to be made only for actual expenses incurred in connection with obtaining information for the FBI. In addition, payments should be made in such a manner that the informant clearly understands he is not being paid on a salary basis but rather on a c.o.d. basis.

1 - San Diego (137-1643)

1 - Mr. M. F. Row (6221 IB)

TPD:fsh  
(6)

fsh

0-1-2-3-4  
6-5-6-9  
9/10/7/11/12

NOTE:

INFORMANT

[SD 1155-S] a white male, 25 years of age and an honorably discharged U.S. Air Force veteran, reveals he is presently undergoing training as a fireman with the San Diego, California, Fire Department. He was designated a criminal informant of the San Diego Office during August, 1967, however, information furnished by him since his development primarily concerns Minutemen activities in the San Diego area. He is the only source of the San Diego Office furnishing such information and

- Tolson \_\_\_\_\_
- DeLoach \_\_\_\_\_
- Mohr \_\_\_\_\_
- Bishop \_\_\_\_\_
- Casper \_\_\_\_\_
- Callahan \_\_\_\_\_
- Conrad \_\_\_\_\_
- Felt \_\_\_\_\_
- Gale \_\_\_\_\_
- Rosen \_\_\_\_\_
- Sullivan \_\_\_\_\_
- Tavel \_\_\_\_\_
- Trotter \_\_\_\_\_
- Tele. Room \_\_\_\_\_
- Holmes \_\_\_\_\_
- Gandy \_\_\_\_\_

DEC 12 1968

NOTE CONTINUED PAGE TWO

MFR  
TWP

MAIL ROOM  TELETYPE UNIT

MAILED 23  
DEC 6 - 1968  
COMM-FBI

Letter to SAC, San Diego  
RE: SD 1155-S  
137-17222

NOTE CONTINUED:

is well acquainted with Troy Haughton, former West Coast leader of the Minutemen. He continues to obtain and make available to the San Diego Office literature distributed by the Minutemen and actively participates in Minutemen meetings and affairs. As a result of informant's background and knowledge of firearms and explosives, he is cognizant of practically all individuals in the San Diego area who deal in weapons and ammunition. He furnishes information on approximately 20 persons actively engaged in Minutemen and ultra-right wing activities in the San Diego area.

Payments to this informant are justified.

UNITED STATES GOVERNMENT

# Memorandum

TO : DIRECTOR, FBI

DATE: 11-13-68

FROM : SAC, SAN DIEGO (134- ) (P)

SUBJECT: HOWARD BARRY GODFREY  
CONF. INFT. SD 1155-S

Informant was designated a criminal informant of the San Diego Division on August 10, 1967. He was furnishing primarily criminal information at the beginning of his development, however, he has continued to direct his efforts toward infiltrating the activities of the Minutemen in the San Diego area. SD 1155-S is the only informant in the San Diego area who is able to furnish any information regarding Minutemen activities up to the present time. Due to the Bureau's continuing interest in the Minutemen activities informant has been encouraged to devote his full time to this activity and it is therefore felt appropriate he should be designated a security informant at this time.

I recommend that authority be granted to make payments to the above informant up to \$75.00 per month for services plus up to \$25.00 per month for expenses actually incurred for a period of six months effective December 1, 1968.

Background information regarding informant has been set out in San Diego letter to the Bureau dated 8-10-67, (Bufile 137-17222), however, appropriate information is being repeated at this time for background purposes.

## I. CHECK OF FIELD OFFICE FILES

A review of the indices of the San Diego Office fail to reflect any derogatory information regarding informant.

## II. CANVAS OF LOGICAL INFORMANTS

A discrete canvas of all logical informants in the San Diego Division in the Security Field has been made and there is no indication that any of these informants are personally acquainted with the informant. It is to be noted that subject's devotes the majority of his time to Minutemen activities and does not participate in activities of the Communist Party or other submersive groups.

- ③ - Bureau  
(1 - 137-17222)
- 3 - San Diego  
(1 - 137-1643)

CJN:blb

(6)

APPROVED  
Date: *[Signature]*

REC 46 137-17222-3

NOV 15 1968

INT. SEC. *[Signature]*

UNRECORDED COPY FILED IN 137-17222-3

12-6-68  
TPD/Hab

### III. PERSONAL HISTORY

Informant is a white male, born 7-1-43, at Portsmouth, England, presently residing at 4582 Maple Street, La Mesa, California. He is presently undergoing training as a firemen with the San Diego Fire Department and has previously been employed at the Pacific Telephone and Telegraph Company, San Diego, California. A review of his employment record at the Telephone Company was made on 5-10-67, at which time it was determined that the employment record contained no derogatory information. Informant has been furnishing information of value to the San Diego Division for approximately 1 1/2 years during which time he has demonstrated himself to be a reliable stable individual, who enjoys a favorable reputation and is believed to be a loyal American citizen with high moral standards and high degree of personal integrity. During his operation as a criminal informant he has demonstrated his ability to develop information in a very discrete manner and has never caused any embarrassment to the Bureau.

### IV. CREDIT AND CRIMINAL RECORDS

A review of local credit and arrest records in the San Diego Division has been made and there is no information of a derogatory nature regarding subject's credit history and no arrest record was located. Form FD 165 has previously been submitted to the Identification Division effective 8-1-67.

### V. ARMED SERVICES RECORD

The master service file of HOWARD BARRY GODREY, serial number AF19724309, was reviewed on 9-12-67, at the Records Service Division, Air Reserve Personnel Center, Denver, Colorado. The file reflects informant born 7-1-43, at Portsmouth, England. He enlisted on 1-18-62, at Phoenix, Arizona, in the grade of Airmen Basic for Service in the U. S. Air Force for a period of four years. He went on extended active duty on 1-18-62. He was separated from the service in the grade of Airmen Second Class on 1-17-66, after being honorably released from active duty upon completion of his enlistment. He received performance ratings ranging from good to excellent and was recommended for an Air Force career. He did not serve outside the continental limits of the United States while in military service and received the Air Force good conduct medal.

SD 134-

His occupational speciality was armament systems helper and weather observer. A complete background was furnished in connection with this record review and the entire record has been preserved in San Diego file 137-1643.

VI. DRAFT STATUS

Inasmuch as informant has served honorably in the U. S. Military Service for a period of four years he is under no current obligation for reserve training and does not participate in any reserve activity at the present time.

VII. DOMESTIC STATUS

Informant is married to CINDY L. GODREY and they are the parents of one child born during the summer of 1968. Informant is known to be a happily married man and has demonstrated his concern for his family in the past and is believed to have a satisfactory domestic and marital status.

VIII. CONSIDERATION FOR USE IN ESPIONAGE AND FOREIGN NATIONALITY CASES

No attempt has been made at this point to encourage or evaluate the participation of informant in espionage or foreign nationality cases, however, it is considered to be very possible for informant to be developed in this area if such a need should develop.

The following information is set out in connection with section 107 (N) of the Manual of Instructions beginning with item #2 of sub 3.

II. RESIDENCE AND EMPLOYMENT

Informant presently resides with his wife at 4582 Maple Street, La Mesa, California. He has previously been employed by the Pacific Telephone and Telegraph Company at 9th and C Streets, San Diego, California, however, he recently terminated this employment and commenced employment with the San Diego Fire Department, August 23, 1968, seeking an increase in pay in order to be able to support his family.

SD 134-

III. CURRENT MEMBERSHIP AND POSITION HELD IN SUBVERSIVE ORGANIZATIONS

Informant is not a current member of any subversive organization but does attend and participate in activities of several groups, which includes the San Diego White Citizen Council, The Peace and Freedom Party, and is extremely active in the activities of the Minutemen in the San Diego, California area.

IV. SUMMARY OF INFORMATION FURNISHED

Since February of 1967 informant has been in close contact with several individual involved in the direction of the Minutemen Group in the San Diego area. He is well acquainted with TROY HAUGHTON, former West Coast leader of the Minutemen and continues to the present time to be in frequent contact with Mrs. BETTY HAUGHTON, since the disappearance of TROY HAUGHTON several months ago. He continues to obtain and to make available to the San Diego Division all publications and printed material distributed by the local Minutemen Organization. Informant is currently one of the three men engaged in the leadership of the Local Total Resistance Organization in the San Diego area, set up as an alliance to work with the Minutemen. Informant has worked with Mr. WILLIAM CLAY and others with the Local Total Resistance Organization. This three man committee is divided in the control of the Organization; Informant is the number 2 man in the group who has been assigned the responsibility for development of intelligence material and the maintaining of records for all activities. Informant is presently under consideration by WILLIAM CLAY as one of the members of the group who might be assigned to travel to the East Coast and attempt to assist in the coordination of activities of such groups as The Loyal Order of Mountainmen and other similar groups in an effort to help direct the activities of all similar groups in coordinating their efforts on a nationwide basis. More specific items are not being enumerated at this point, inasmuch as this information has been previously furnished to the Bureau in Bufile 137-17222.

V. AMOUNT PAID FOR SERVICES AND EXPENSES

From March of 1967 to July 31, 1968, informant has been paid a total of \$400.00 for expenses and services rendered.

VI. TYPE AND NUMBER OF MEETINGS ATTENDED AND OTHER ACTIVITY

Informant attends numerous activities of a varied nature including participation in Minutemen activities, planning and council meetings of the Minutemen, as well as, fullfills assignments to work at the headquarters of the Peace and Freedom Party, the American Nazi Party, San Diego Council for Social Action, and the Patriotic Party, where he attempts to obtain information and records of those groups for use by the Minutemen. In addition to meetings attended the informant makes numerous visits to the homes of people participating in Minutemen and other activities including the residents of TROY HAUGHTON, where he attempts to keep track of the activities of Mrs. BETTY HAUGHTON during the absence of her husband, former regional director of the West Coast Minutemen activities.

VII. NUMBER OF WRITTEN AND ORAL STATEMENTS SUBMITTED

Informant has been submitting primarily oral information with the exception of printed bulletins and other material which he obtains from various mailing rooms of organizations he visits, as well as obtaining names, addresses and membership lists of individuals participating in various group activities.

VIII. INFORMATION FURNISHED OF UNUSUAL VALUE

Through his close association with the HAUGHTON family informant has maintained a relationship which has enabled him to keep the San Diego Division apprised of the activities of BETTY HAUGHTON since the disappearance of her husband TROY HAUGHTON several months ago. Informant has also been furnishing information relative to the obtaining and stock piling weapons and ammunition by numerous individuals in the San Diego area.

IX. APPROXIMATE NUMBER OF PERSONS ON WHOM INFORMANT FURNISHED COVERAGE AND THEIR IMPORTANCE

Through informants background and wide knowledge of firearms and explosives he is closely acquainted with practically all individuals in the San Diego area who deal in weapons and ammunition. This includes approximately 25 individuals who not only buy and sell weapons and ammunition in the San Diego area but who also travel to Los Angeles and Yuma, Arizona, where they purchase weapons and bring them to the San Diego area for resale. Inasmuch as



SD 134-

informant is closely associated with these individuals he is able to furnish specific information regarding numerous purchases and the sales by such people. In addition to these individuals informant also acquainted with approximately 20 people actively engaged in Minutemen and related type groups in the San Diego area. Informant also knows by sight numerous individuals who attend such activities as those sponsored by the Patriotic Party, the Peace and Freedom Party and the San Diego County White Citizen Council Meetings.

X. STEPS BEING TAKEN TO ADVANCE INFORMANT

Informant has been encouraged to continue his progress in the Local Minutemen Organization to the extent that he is closely associated with WILLIAM CLAY, who is one of the apparent leaders of the Minutemen activity in the Southern California area. Through his association with CLAY the informant has been able to furnish considerable information relative to plans and programs of the Minutemen in the San Diego area. Informant will continue his association with BETTY HAUGHTON and others who are apparently in positions of leadership in the Minutemen activities in the San Diego area.

XI. STABILITY AND RELIABILITY

Since the initial development of the informant there have been no situations occur which have caused any embarrassment to the Bureau nor has there been any situation occur which would cause any question relative to the emotional stability of the informant. With regard to his domestic situation he is believed to be a happily married man and with the exception of the recent critical condition of a newborn child has had no extreme personal difficulties. In connection with the birth of his child the informant reported that immediately the child's birth in July of 1968, doctors felt that heart surgery would be necessary and that a cathORIZATION would have to be performed. The surgery was subsequently performed and after three weeks in the hospital the child was allowed to be taken home and at the present time is reported by the informant to be in a very satisfactory condition.

XII. INDOCTRINATION AGAINST DISCLOSURE

SD 134-

Informant is cautioned at each contact that he must maintain strict security in connection with the information which he furnishes to the FBI. It is to be noted that the informant is extremely cautious with regard to his association with the Bureau, inasmuch as he realizes that there is considerable personal danger should any disclosure arise relative to his activities in connection with the meetings he attends and his relationship with those people involved in extreme right wing activities. Contacts with the informant are made at irregular times and in varied locations so there is very little likelihood that detection made of informant's contact with the FBI.

XIII. ALL NECESSARY ACTION TAKEN ON INFORMATION FURNISHED

The Bureau and all appropriate offices have been properly advised of information which has been furnished in the past by the informant relative to matters of Bureau interest. Items of a local nature furnished by the informant have been disseminated to local police agencies involving information of value to local agencies.

XIV. MISCELLANEOUS

Due to extensive training and interest on the part of the informant he is extremely well qualified with regard to identification and use of all types of weapons and ammunition including newest types of explosives. His background in this area has been of particular interest in qualifying him for assisting the Minutemen and other groups in developing technical data regarding explosives and arms and ammunitions.

UACB the San Diego Division will continue to contact this informant and consider him to be a security informant and information furnished by him will be handled on that basis. Any criminal information which is furnished by the informant will continue to be accepted and will be appropriately disseminated.

DIRECTOR, FBI

11-13-68

SAC, SAN DIEGO (134- ) (P)

HOWARD BARRY GODFREY

SD 1155-S Informant

Informant was designated a criminal informant of the San Diego Division on August 10, 1967. He was furnishing primarily criminal information at the beginning of his development, however, he has continued to direct his efforts toward infiltrating the activities of the Minutemen in the San Diego area. SD 1155-S is the only informant in the San Diego area who is able to furnish any information regarding Minutemen activities up to the present time. Due to the Bureau's continuing interest in the Minutemen activities informant has been encouraged to devote his full time to this activity and it is therefore felt appropriate he should be designated a security informant at this time.

I recommend that authority be granted to make payments to the above informant up to \$15.00 per month for services plus up to \$25.00 per month for expenses actually incurred for a period of six months effective December 1, 1968.

Background information regarding informant has been set out in San Diego letter to the Bureau dated 8-10-67, (Bufile 157-17222), however, appropriate information is being repeated at this time for background purposes.

I. CHECK OF FIELD OFFICE FILES

A review of the indices of the San Diego Office fail to reflect any derogatory information regarding informant.

II. CANVAS OF LOGICAL INFORMANTS

A discrete canvas of all logical informants in the San Diego Division in the Security Field has been made and there is no indication that any of these informants are personally acquainted with the informant. It is to be noted that subject's devotes the majority of his time to Minutemen activities and does not participate in activities of the Communist Party or other subversive groups.

3 - Bureau  
(1 - 137-17222)  
3 - San Diego  
(1 - 151-1643)

137-17222  
NOT RECORDED  
87 NOV 15 1968

CJN:dlb  
(6)

ORIGINAL FILED IN 157-17222-37

### III. PERSONAL HISTORY

Informant is a white male, born 7-1-43, at Portsmouth, England, presently residing at 4582 Maple Street, La Mesa, California. He is presently undergoing training as a firemen with the San Diego Fire Department and has previously been employed at the Pacific Telephone and Telegraph Company, San Diego, California. A review of his employment record at the Telephone Company was made on 5-10-67, at which time it was determined that the employment record contained no derogatory information. Informant has been furnishing information of value to the San Diego Division for approximately 1 1/2 years during which time he has demonstrated himself to be a reliable stable individual, who enjoys a favorable reputation and is believed to be a loyal American citizen with high moral standards and high degree of personal integrity. During his operation as a criminal informant he has demonstrated his ability to develop information in a very discrete manner and has never caused any embarrassment to the Bureau.

### IV. CREDIT AND CRIMINAL RECORDS

A review of local credit and arrest records in the San Diego Division has been made and there is no information of a derogatory nature regarding subject's credit history and no arrest record was located. Form FD 165 has previously been submitted to the Identification Division effective 8-1-67.

### V. ARMED SERVICES RECORD

The master service file of HOWARD BARRY GODREY, serial number AFL9724309, was reviewed on 9-12-67, at the Records Service Division, Air Reserve Personnel Center, Denver, Colorado. The file reflects informant born 7-1-43, at Portsmouth, England. He enlisted on 1-18-62, at Phoenix, Arizona, in the grade of Airmen Basic for Service in the U. S. Air Force for a period of four years. He went on extended active duty on 1-18-62. He was separated from the service in the grade of Airmen Second Class on 1-17-66, after being honorably released from active duty upon completion of his enlistment. He received performance ratings ranging from good to excellent and was recommended for an Air Force career. He did not serve outside the continental limits of the United States while in military service and received the Air Force good conduct medal.

SD 134-

His occupational speciality was armament systems helper and weather observer. A complete background was furnished in connection with this record review and the entire record has been preserved in San Diego file 137-1643.

#### VI. DRAFT STATUS

Inasmuch as informant has served honorably in the U. S. Military Service for a period of four years he is under no current obligation for reserve training and does not participate in any reserve activity at the present time.

#### VII. DOMESTIC STATUS

Informant is married to CINDY L. GODREY and they are the parents of one child born during the summer of 1968. Informant is known to be a happily married man and has demonstrated his concern for his family in the past and is believed to have a satisfactory domestic and marital status.

#### VIII. CONSIDERATION FOR USE IN ESPIONAGE AND FOREIGN NATIONALITY CASES

No attempt has been made at this point to encourage or evaluate the participation of informant in espionage or foreign nationality cases, however, it is considered to be very possible for informant to be developed in this area if such a need should develop.

The following information is set out in connection with section 107 (N) of the Manual of Instructions beginning with item #2 of sub 3.

#### II. RESIDENCE AND EMPLOYMENT

Informant presently resides with his wife at 4582 Maple Street, La Mesa, California. He has previously been employed by the Pacific Telephone and Telegraph Company at 9th and C Streets, San Diego, California, however, he recently terminated this employment and commenced employment with the San Diego Fire Department, August 23, 1968, seeking an increase in pay in order to be able to support his family.

III. CURRENT MEMBERSHIP AND POSITION HELD IN SUBVERSIVE ORGANIZATIONS

Informant is not a current member of any subversive organization but does attend and participate in activities of several groups, which includes the San Diego White Citizen Council, The Peace and Freedom Party, and is extremely active in the activities of the Minutemen in the San Diego, California area.

IV. SUMMARY OF INFORMATION FURNISHED

Since February of 1967 informant has been in close contact with several individual involved in the direction of the Minutemen Group in the San Diego area. He is well acquainted with TROY HAUGHTON, former West Coast leader of the Minutemen and continues to the present time to be in frequent contact with Mrs. BETTY HAUGHTON, since the disappearance of TROY HAUGHTON several months ago. He continues to obtain and to make available to the San Diego Division all publications and printed material distributed by the local Minutemen Organization. Informant is currently one of the three men engaged in the leadership of the Local Total Resistance Organization in the San Diego area, set up as an alliance to work with the Minutemen. Informant has worked with Mr. WILLIAM CLAY and others with the Local Total Resistance Organization. This three man committee is divided in the control of the Organization. Informant is the number 2 man in the group who has been assigned the responsibility for development of intelligence material and the maintaining of records for all activities. Informant is presently under consideration by WILLIAM CLAY as one of the members of the group who might be assigned to travel to the East Coast and attempt to assist in the coordination of activities of such groups as The Loyal Order of Mountainmen and other similar groups in an effort to help direct the activities of all similar groups in coordinating their efforts on a nationwide basis. More specific items are not being enumerated at this point, inasmuch as this information has been previously furnished to the Bureau in Bufile 137-17222.

V. AMOUNT PAID FOR SERVICES AND EXPENSES

From March of 1967 to July 31, 1968, informant has been paid a total of \$400.00 for expenses and services rendered.

VI. TYPE AND NUMBER OF MEETINGS ATTENDED AND OTHER ACTIVITY

Informant attends numerous activities of a varied nature including participation in Minutemen activities, planning and council meetings of the Minutemen, as well as, fullfills assignments to work at the headquarters of the Peace and Freedom Party, the American Nazi Party, San Diego Council for Social Action, and the Patriotic Party, where he attempts to obtain information and records of those groups for use by the Minutemen. In addition to meetings attended the informant makes numerous visits to the homes of people participating in Minutemen and other activities including the residence of TROY HAUGHTON, where he attempts to keep track of the activities of Mrs. BETTY HAUGHTON during the absence of her husband, former regional director of the West Coast Minutemen activities.

VII. NUMBER OF WRITTEN AND ORAL STATEMENTS SUBMITTED

Informant has been submitting primarily oral information with the exception of printed bulletins and other material which he obtains from various mailing rooms of organizations he visits, as well as obtaining names, addresses and membership lists of individuals participating in various group activities.

VIII. INFORMATION FURNISHED OF UNUSUAL VALUE

Through his close association with the HAUGHTON family informant has maintained a relationship which has enabled him to keep the San Diego Division apprised of the activities of BETTY HAUGHTON since the disappearance of her husband TROY HAUGHTON several months ago. Informant has also been furnishing information relative to the obtaining and stockpiling weapons and ammunition by numerous individuals in the San Diego area.

IX. APPROXIMATE NUMBER OF PERSONS ON WHOM INFORMANT FURNISHED COVERAGE AND THEIR IMPORTANCE

Through informants background and wide knowledge of firearms and explosives he is closely acquainted with practically all individuals in the San Diego area who deal in weapons and ammunition. This includes approximately 25 individuals who not only buy and sell weapons and ammunition in the San Diego area but who also travel to Los Angeles and Yuma, Arizona, where they purchase weapons and bring them to the San Diego area for resale. Inasmuch as

informant is closely associated with these individuals he is able to furnish specific information regarding numerous purchases and the sales by such people. In addition to those individuals informant also acquainted with approximately 20 people actively engaged in Minutemen and related type groups in the San Diego area. Informant also knows by sight numerous individuals who attend such activities as those sponsored by the Patriotic Party, the Peace and Freedom Party and the San Diego County White Citizen Council Meetings.

X. STEPS BEING TAKEN TO ADVANCE INFORMANT

Informant has been encouraged to continue his progress in the Local Minutemen Organization to the extent that he is closely associated with WILLIAM CLAY, who is one of the apparent leaders of the Minutemen activity in the Southern California area. Through his association with CLAY the informant has been able to furnish considerable information relative to plans and programs of the Minutemen in the San Diego area. Informant will continue his association with BETTY HAUGHTON and others who are apparently in positions of leadership in the Minutemen activities in the San Diego area.

XI. STABILITY AND RELIABILITY

Since the initial development of the informant there have been no situations occur which have caused any embarrassment to the Bureau nor has there been any situation occur which would cause any question relative to the emotional stability of the informant. With regard to his domestic situation he is believed to be a happily married man and with the exception of the recent critical condition of a newborn child has had no extreme personal difficulties. In connection with the birth of his child the informant reported that immediately the child's birth in July of 1968, doctors felt that heart surgery would be necessary and that a cathORIZATION would have to be performed. The surgery was subsequently performed and after three weeks in the hospital the child was allowed to be taken home and at the present time is reported by the informant to be in a very satisfactory condition.

XII. INDOCTRINATION AGAINST DISCLOSURE



SD 134-

Informant is cautioned at each contact that he must maintain strict security in connection with the information which he furnishes to the FBI. It is to be noted that the informant is extremely cautious with regard to his association with the Bureau, inasmuch as he realizes that there is considerable personal danger should any disclosure arise relative to his activities in connection with the meetings he attends and his relationship with those people involved in extreme right wing activities. Contacts with the informant are made at irregular times and in varied locations so there is very little likelihood that detection made of informants contact with the FBI.

XIII. ALL NECESSARY ACTION TAKEN ON INFORMATION FURNISHED

The Bureau and all appropriate offices have been properly advised of information which has been furnished in the past by the informant relative to matters of Bureau interest. Items of a local nature furnished by the informant have been disseminated to local police agencies involving information of value to local agencies.

XIV. MISCELLANEOUS

Due to extensive training and interest on the part of the informant he is extremely well qualified with regard to identification and use of all types of weapons and ammunition including newest types of explosives. His background in this area has been of particular interest in qualifying him for assisting the Minutemen and other groups in developing technical data regarding explosives and arms and ammunitions.

UACB the San Diego Division will continue to contact this informant and consider him to be a security informant and information furnished by him will be handled on that basis. Any criminal information which is furnished by the informant will continue to be accepted and will be appropriately disseminated.

UNITED STATES GOVERNMENT

# Memorandum

*File*

TO : SAC, San Diego (Your file \_\_\_\_\_) DATE: 11/25/68

FROM : Director, FBI (Bufile and Serial 137-17222)  
Room No.                     

Post in file and destroy 0-1  
(For SOG use only)

SUBJECT: SD 1155-C Informant

1. Bufiles indicate this case is delinquent. Give specific reason for delinquency.

Letter submitted 11/13/68 recommending informant be designated as security informant.

airtel       letterhead memo       submitted  
 2. DATE  report       90-day progress letter       will be submitted \_\_\_\_\_  
 letter

Reporting employee \_\_\_\_\_

3. If valid reason exists for not submitting report at this time, state reason specifically and when report will be submitted \_\_\_\_\_

4. Status of  Appeal       Inquiry       Investigation  
 airtel       letterhead memo  
 5. Submit  report       90-day progress letter      by \_\_\_\_\_  
 letter

SEARCHED _____	INDEXED _____
SERIALIZED _____	FILED _____
NOV 27 1968	
FBI - SAN DIEGO	
(Date)	

*CT*  
*[Signature]*

(Place reply hereon and return to Bureau. Note receipt and acknowledgment on top serial of case file.)

7149

U. S. GOVERNMENT PRINTING OFFICE: 1965 O - 781-652  
907-748

*File 9 abn*

UNITED STATES GOVERNMENT

# Memorandum

TO : DIRECTOR, FBI (137-17222)

DATE: 3/21/69 *MB/A*

FROM : SAC, SAN DIEGO (134-914)

SUBJECT: CONF. INFT.  
SD 1155-S *Informant*

*Re: [unclear] view subject*

Re San Diego letter to the Bureau dated 11/13/68 and Bureau letter to San Diego dated 12/6/68.

The Bureau is advised that captioned informant is using the code name JEROME in furnishing written reports to the Bureau.

- ② - Bureau
- 2 - San Diego

SLC:mtg  
(4)

*id*

*see under*

REC-21  
MET-40

137-17222-4

10 MAR 26 1969

[INT. SEC.]

159  
54 APR 4 - 1969

1 - Mr. C. D. Brennan (SF)  
1 - Mr. J.F. Farr

SAC, San Diego (154-914)

7/2/69

SR

Director, FBI (157-17223)-5

REC-138

SD 1155-S  
EM 103 / 1/2/69

Reurlet 6/18/69.

Authority is granted to increase payments to captured informant from \$75 per month up to \$100 per month for services rendered and to continue payment of expenses at the same rate of up to \$25 per month for expenses actually incurred for six months effective 6/1/69.

Concerning your payments to this informant, you are reminded that payments must be commensurate with the value of information received and that payments for expenses are to be made only for those actually incurred. The informant should clearly understand that he is not being paid on a salary basis.

Advise Agent and stenographic personnel of your office in letters such as referenced letter only the first page of the carbon copy of these letters should be typed and transmitted to the Bureau. To type more than this is inefficient and a waste of time and is not in accordance with existing instructions. You should also advise Agent personnel that payment justification letters should be submitted two weeks prior to the date when the authorization is due.

1 - Mr. M.F. Row (6221 IB)

JFF:slg

(6)

NOTE: *slg* *informant* *7-1-69*

SD 1155-S 25 years old, and a honorable discharged U.S. Air Force veteran, has been undergoing training as a fireman with the San Diego, California, Fire Department. He was designated a criminal informant of the San Diego Office in August, 1967, however, information furnished by him since his development primarily concerns Minutemen activities in the San Diego area. He is the primary source of such activities in the area, and has furnished information regarding plans of the organization and background of its leaders and members. He has also provided coverage of New Left activities. He is in contact with members and officers of the Minutemen several times weekly, has attended meetings of a gun club and the American Volunteer Club, both of which are patronized by the Minutemen. He has been at a number of New Left rallies and demonstrations. He has submitted 15 written and 19 oral reports. Increase in payments is warranted.

- Tolson \_\_\_\_\_
- DeLoach \_\_\_\_\_
- Mohr \_\_\_\_\_
- Bishop \_\_\_\_\_
- Casper \_\_\_\_\_
- Callahan \_\_\_\_\_
- Conrad \_\_\_\_\_
- Felt \_\_\_\_\_
- Gale \_\_\_\_\_
- Rosen \_\_\_\_\_
- Sullivan \_\_\_\_\_
- Tavel \_\_\_\_\_
- Trotter \_\_\_\_\_
- Tele. Room \_\_\_\_\_
- Holmes \_\_\_\_\_
- Gandy \_\_\_\_\_

MAILED 24  
JUL - 2 1969  
COMM-FBI

UNITED STATES GOVERNMENT

# Memorandum

TO : DIRECTOR, FBI (137-17222)

DATE: 6/16/69

FROM : SAC, SAN DIEGO (134-914) (P)

SUBJECT: SD 1155-S Informant  
SI

Re San Diego letter to the Bureau 3/21/69, approving up to \$75 per month for services and up to \$25 per month for expenses incurred on a C.O.D. basis from 12/1/68 to 6/1/69.

I. RECOMMENDATION

*Increase \$25*

It is recommended that increased authority be granted to pay the above SI up to \$100 per month for services rendered and up to \$25 per month for expenses actually incurred for a period of six months, effective 6/1/69. An additional \$25 monthly is requested for services due to expected increased activity of the Minutemen organization in the San Diego area and informant's increased importance in the organization.

II. RESIDENCE AND EMPLOYMENT

SI resides at 738 Graves, El Cajon, California, and is employed full time by the San Diego City Fire Department.

*[Signature]*

III. CURRENT MEMBERSHIP IN SUBVERSIVE ORGANIZATIONS

Informant is considered a member of the local Minutemen organization.

IV. SUMMARY OF INFORMATION FURNISHED DURING PERTINENT PERIOD

During the period 12/1/68 to 6/1/69, informant has continuously participated in Minutemen activities in the San Diego area. He has furnished information on the plans of this organization and background information on its leaders and members. Informant has also provided coverage of several New Left activities by attending or participating anonymously. This informant is not the only source of information concerning the Minutemen organization in the San Diego area. However, he is the primary source of such information.

AMOUNT PAID FOR SERVICES AND EXPENSES

137-17222-5

Date	Services	Expenses
12/12/68	\$35.00	\$15.00
1/17/69	40.00	10.00
2/13/69	35.00	15.00
3/12/69	37.00	13.00

REC 36

INT. SEC.

(2) - Bureau (RM)  
2 - San Diego  
SLC:pgh/mt (4)

V. AMOUNT PAID FOR SERVICES AND EXPENSES, continued

<u>Date</u>	<u>Services</u>	<u>Expenses</u>
3/28/69	\$36.00	\$12.00 ✓
4/18/69	29.00	11.00
5/7/69	37.50	12.50

VI. TYPE AND NUMBER OF MEETINGS ATTENDED AND OTHER ACTIVITIES

While the local Minutemen organization holds no regular meetings, the informant is in contact several times weekly with leaders and members of the group. In addition, he has attended meetings of a gun club and also of the American Volunteer Group, both of which are patronized by Minutemen. He has also been present at several New Left rallies and demonstrations.

VII. NUMBER OF WRITTEN AND ORAL REPORTS SUBMITTED

Written - 15 reports  
Oral - 19 reports

VIII. INFORMATION FURNISHED OF UNUSUAL VALUE

Informant has been the primary source of information relating to the Minutemen organization and the activities of its members in the San Diego area. He has provided advance information on the plans of the Minutemen organization and also the activities of several New Left and black militant organizations, in San Diego.

IX. APPROXIMATE NUMBER OF PERSONS ON WHOM INFORMANT HAS FURNISHED COVERAGE AND THEIR IMPORTANCE

SI is currently furnishing information on ten or fifteen individuals who are active in the Minutemen organization, in addition to a number of individuals who are sympathetic to the organization. Informant has also furnished information on speakers and organizers of local New Left organizations.

X. STEPS BEING TAKEN TO ADVANCE THE INFORMANT

Informant has gravitated to a position of trust and confidence with the recognized leaders of the local Minutemen organization. At the present time, SI is probably the third or

SD 134-914 .

fourth most prominent member of the organization. He has been instructed to avail himself of every opportunity to enhance his position in the organization.

XI. STABILITY AND RELIABILITY

Informant has exhibited no indications of personal weakness, untrustworthiness, unreliability or other problems and steps are being taken to guard against future situations which may possibly embarrass the Bureau.

XII. INDOCTRINATION AGAINST DISCLOSURE

Informant has been properly indoctrinated against making any disclosure in any manner of his relationship with the Bureau. He has been operating as a symbol number informant for the San Diego Division since August, 1967.

XIII. ALL NECESSARY ACTION TAKEN  
ON INFORMATION FURNISHED

All necessary action has been taken in information furnished by the informant.

UNITED STATES GOVERNMENT

# Memorandum

TO : DIRECTOR, FBI (137-17222) DATE: 11/17/69

FROM : SAC, SAN DIEGO (134-914)

SUBJECT: ~~CONF. INFO.~~  
~~SD 1155-SI~~ Informant  
SI SECURITY  
RE: ~~INTERNAL~~ INFORMANT PROGRESS/JUSTIFICATION LETTER

I.  (a) I recommend that authority be granted to continue captioned informant for a period of \_\_\_\_\_ months and that he continue to be paid under the authority of the Special Agent in Charge, UACB.

(b) I recommend that authority be granted to pay captioned informant an amount up to \$ 100 per  month  week for services rendered on a c.o.d. basis, and up to \$ 25 per  month  week for expenses actually incurred for a period of six  months  weeks effective 12/1/69.  
(If increase, furnish full justification under "Miscellaneous.")

II. Membership: Informant is a member of the Minutemen Organization in the San Diego area.

Amount paid for services and expenses:

Date	Services	Expenses
6/11/69	\$70.00	9.60
8/5/69	65.00	16.43
10/10/69	45.00	12.49
11/10/69	95.00	21.50

Number of activities and persons on whom coverage is provided: Informant reports regularly on activities of 30 - 40 members of the Minutemen Organization and related right wing organizations at San Diego, California. In addition informant is acquainted with approximately five persons connected with the publishing of the "San Diego Free Door to Liberation", a San Diego underground newspaper and reports on activities connected to it. Due to free time available to the informant by the nature of his employment, he is able to observe and report on activities of radical and militant individuals and organizations, both on and off college campuses in the San Diego area.

Number of statements (written and oral) submitted: 24

Considered stable and reliable  Yes  No (Explain in "Miscellaneous.")

Indoctrinated against disclosure  Yes

Percentage of information verified 95%

All necessary action taken on information furnished  Yes  No (Explain in "Miscellaneous.")

3 Bureau (AM-RM)  
San Diego

APPROVED

Date

DEC 2 1969

137-17222-6

NOV 20 1969

REC-47

Rozell

M. F. HOW

62211B

MAILED 23  
DEC 2 - 1969  
COMM-FBI

50 DEC 4 1969  
NW 55000  
D-110: 2389 (2)  
MAIL ROOM



Summary of information furnished: (If more space needed, add addendum.) On 9/7/69, informant reported WILLIAM CLAY, local leader of the Minutemen Organization, allegedly has in his possession a large quantity of Composition C high explosive.

On 9/8/69, informant advised that LYLE MANNING, local right wing sympathizer and owner of a gun store and swap shop, is allegedly buying and selling stolen military equipment and is sending weapons to Servicemen in Vietnam.

On 9/12/69, informant reported WILLIAM CLAY will become more active in Minutemen activities and in order to protect his family, has moved into an apartment in El Cajon, California, to make it appear he has separated from his wife.

On 9/16/69, informant advised of the formation of the new right wing organization known as Virtue In America. This organization was established by PAUL RUPLINGER, a Minutemen member and friend of WILLIAM CLAY. Informant provided the names of 22 persons believed to be members of or interested in this organization.

(See attached Addendum, page 2a)

Miscellaneous: (Furnish any change in residence and employment, steps being taken to advance informant, and any other pertinent information which should be brought to Bureau's attention.)

The informant is being encouraged to take advantage of any opportunities to enhance his position in the Minutemen Organization and in other right wing groups. He is also being encouraged to penetrate left wing activities and to gain the confidence of individuals involved therein wherever possible.

Informant has been instructed to report all compensation received from the Bureau for services as income when filing an income tax return and he has agreed to comply.

ADDENDUM

SUMMARY OF INFORMATION FURNISHED: (Continued)

During the period 10/8 - 15/69, informant provided coverage of "Stop the War Week" sponsored by the Student Mobilization Committee at San Diego State College. Coverage included photographs taken by the informant which allowed the identification of several previously unknown militant leaders at San Diego State College. One of these was HARRY RUJA, San Diego State College professor who on 10/15/69 admitted to informant he had solicited donations for the Viet Cong.

During this same period of time, informant provided coverage of right wing harassment activities on the San Diego State College campus including the placing of Minutemen stickers, painting out the names of San Diego area Vietnam war dead on a signboard prepared by the Student Mobilization Committee, and the hanging in effigy of ANGELA DAVIS, self-admitted Communist and Black Panther Party member.

On 10/3/69, informant reported on activities of LEON NOWER, Professor at San Diego State College, including his involvement in the Exploring Family School, a school organized by San Diego area radical individuals and designed to teach revolutionary thoughts and ideas to elementary age school children.

On 10/28/69, informant advised the "San Diego Free Door to Liberation", a San Diego underground newspaper, had moved to a new address and was planning a small protest demonstration on the occasion of the National Convention of the Sigma Delta Chi Fraternity, a society of journalists at San Diego, California, on 11/13/69.

During the period 10/15/69 - 11/14/69, informant has provided information relating to preparations by militant individuals at San Diego, California, for the DEMNOV Demonstrations on 11/15/69 and right wing plans to harass those activities occurring in San Diego area on that date.

SAC, San Diego (170-286)

6-18-70

EX-115

Director, FBI (157-17222) — 7

1-Mr. J. G. Deegan  
1-Mr. R. L. Ridgeway

REC-128

SD 1155-R

*informant*

Reurlet 6-3-70.

In view of informant's membership in the Minutemen organization and the nature of information he furnishes, he is being designated a racial informant and should be carried as such in the future.

Pursuant to your recommendation, authority granted to make payments to captioned informant at a level of up to \$250 per month for services and up to \$100 per month for expenses, for a period of six months, effective 6-1-70. This payment authorization represents an increase to previous payment levels of up to \$150 for services and up to \$75 per month for expenses. Be certain all payments to this informant are commensurate with the value of information received and actual expenses incurred on a c.o.d. basis.

It has been noted in the past that you have been making payments to this informant in even amounts of \$100 for services. You should refrain from making payments in the exact amount each time in order to avoid having informant reach the erroneous conclusion that he is being paid on a salary basis. Therefore, in the future, stagger amounts of payments to this informant.

1-Mr. M. F. Row 6221, IB

RLR:djw  
(6)

NOTE:

Informant is a 26-year-old white male employed as a fireman in San Diego, California. He was designated a criminal informant in August, 1967, and converted to a security informant in December, 1968. Since 1968, he has furnished

MAILED 9  
JUN 18 1970  
COMM-FBI

- Tolson \_\_\_\_\_
- DeLoach \_\_\_\_\_
- Walters \_\_\_\_\_
- Mohr \_\_\_\_\_
- Bishop \_\_\_\_\_
- Casper \_\_\_\_\_
- Callahan \_\_\_\_\_
- Conrad \_\_\_\_\_
- Felt \_\_\_\_\_
- Gale \_\_\_\_\_
- Rosen \_\_\_\_\_
- Sullivan \_\_\_\_\_
- Tavel \_\_\_\_\_
- Soyars \_\_\_\_\_
- Tele. Room \_\_\_\_\_
- Holmes \_\_\_\_\_
- Gandy \_\_\_\_\_

NOTE CONTINUED PAGE TWO

Letter to San Diego  
RE: SD 1155-R  
137-17222

NOTE CONTINUED:

information on the Minutemen and related groups in the San Diego area. He has also furnished reports on meetings, demonstrations, and other activities of the Student Mobilization Committee, and the San Diego Citizens Mobilization Committee; advanced information concerning the eviction of the militant New Left underground newspaper, "The San Diego Street Journal." He has also furnished information concerning conferences of Students for a Democratic Society and advanced information of militant students' plans to seize a part of the Administration Building, San Diego State College. He is not contacted on campus and not affiliated with an educational institution. During pertinent period, he furnished 87 reports of which 95 percent of information verified through other sources. Current payment levels are \$100 per month for services and \$25 per month for expenses. An increase in payments as authorized above fully justified, based on a value of information furnished and informant potential. This has been coordinated with the Security Informant Unit.

UNITED STATES GOVERNMENT

# Memorandum

TO : DIRECTOR, FBI (137-17222) DATE: 6/3/70

FROM : SAC, SAN DIEGO (170-286) (P)

*J. R. Moore*

SUBJECT:

~~CONF. INFO.~~  
SD 1155-S  
SI

Re: RACIAL OR SECURITY INFORMANT PROGRESS/JUSTIFICATION LETTER

I.  (a) I recommend that authority be granted to continue captioned informant for a period of \_\_\_\_\_ months effective \_\_\_\_\_ and that he continue to be paid under the authority of the Special Agent in Charge, UACB.

(b) I recommend that authority be granted to pay captioned informant an amount up to \$ 250 per  month  week for services rendered on a c.o.d. basis, and up to \$ 100 per  month  week for expenses actually incurred for a period of six  months  weeks effective 6/1/70.  
(If increase, furnish full justification under "Miscellaneous.")

*P*

II. Membership: Informant is a member of the Minutemen Group in the San Diego area.

Amount paid for services and expenses:

Date	Period Covered	Services	Expenses
12/15/69	11/1 - 30/69	\$100	\$19.36
1/16/70	12/1 - 31/69	\$100	\$22.43

*PROG*

(See attached Addendum, page 2a)

Number of activities and persons on whom coverage is provided:

Informant reports regularly on activities of 30 to 40 individuals associated with the Minutemen organization and related right wing organizations in San Diego, California. He continues to be employed by the San Diego City Fire Department and consequently has considerable free time available to use in observing and reporting on activities of a number of radical and militant individuals and organizations both on and off college campuses in the San Diego area. Informant has attended and reported on planning meetings, demonstrations, and other activities of such organizations as the San Diego Citizens Mobilization Committee (CMC) and Student Mobilization Committee (SMC) to end the war in Vietnam and the Movement for a Democratic

(See attached Addendum, page 2a)  
Number of statements (written and oral) submitted: 87

137-17222-7

Considered stable and reliable  Yes  No (Explain in "Miscellaneous.")

Indoctrinated against disclosure  Yes

Percentage of information verified 95%

All necessary action taken on information furnished  Yes  No (Explain in "Miscellaneous.")

3 - Bureau  
1 - San Diego  
SLC:kdw (4)

REC-128  
JUN 8 1970  
RAE, SEC.

Summary of information furnished: (If more space needed, add addendum.)

On 11/17/69, 3/5/70, 3/11/70, 3/20/70 and 3/21/70, informant furnished an extremely large volume of information consisting mostly of names and addresses of persons supporting or sympathetic to New Left oriented activities in and around San Diego which were obtained through harrassment activities of right wing groups and individuals in the San Diego area.

On 12/8/69, informant provided advance information regarding the eviction of the San Diego Street Journal, a militant New Left oriented underground newspaper from its offices at 360 Fifth Avenue, San Diego, California, because of general disturbances and harrassment activities directed against the Street Journal and the landlord.

On 1/8/70, informant reported that WILLIAM CLAY, San Diego area leader of the Minutemen Organization, had traveled during the last two weeks of December, 1969, throughout several western states for the purpose of making contact with Minutemen and right wing groups and individuals to establish some kind of communications and contact network. Informant advised CLAY was extremely pleased with the results of his trip.

(See attached Addendum page 2a)

Miscellaneous: (Furnish any change in residence and employment, steps being taken to advance informant, and any other pertinent information which should be brought to Bureau's attention.)

Informant has been instructed to report all compensation received from the Bureau for services as income when filing an income tax return and he has agreed to comply.

It is noted an increase in the amount of money to be authorized for payment of services and expenses to the informant is requested. Informant has provided large volumes of information concerning activities of both right and left wing individuals and organizations in the San Diego area and regularly contacts the San Diego Office several times weekly. It is felt the time and effort given on the part of the informant in providing this coverage to the Bureau is worth well in excess of the amount previously authorized. In addition, informant has stated that with additional expense money available, he would be able to provide greater in depth coverage of activities of Minutemen and other right wing extremist individuals, especially with regard to the sales and movements of weapons, ammunition and explosives.

Informant continues to be encouraged to take advantage of any opportunities to improve his coverage of activities of interest to the Bureau in the San Diego area.

AMOUNT PAID FOR SERVICES AND EXPENSES (Continued):

<u>Date</u>	<u>Period Covered</u>	<u>Services</u>	<u>Expenses</u>
3/3/70	1/1 - 31/70	\$100	\$16.29
3/30/70	2/1 - 28/70	\$100	\$24.33
4/24/70	3/1 - 31/70	\$100	\$21.93
6/2/70	4/1 - 30/70	\$100	\$14.13
6/2/70	5/1 - 31/70	\$100	\$12.00

NUMBER OF ACTIVITIES AND PERSONS ON WHOM COVERAGE IS PROVIDED (Continued):

Military (MDM). Informant has traveled to Oceanside, California, to cover activities of MDM there.

SUMMARY OF INFORMATION FURNISHED: (Continued)

On 1/8/70, informant reported that through contact with the publisher of the San Diego Free Door to Liberation, a local underground newspaper he had learned the paper is losing money and that the publisher had found it necessary to use money from his savings and from other funds to continue printing the paper.

On 1/20/70, informant provided advance information regarding a conference of the Students for a Democratic Society, which was to be held at Los Angeles, California, during the period 1/24 - 25/70. Subsequently, informant provided information regarding the conference itself. ✓

On 3/12/70, informant provided advance information on the seizure of part of the Administration Building at San Diego State College by students protesting administration action regarding four professors and lecturers popular with the many militant and radical students at the school. Informant continued to provide coverage of the progress of the demonstration until its conclusion on 3/17/70. //

On 3/23/70, informant reported on the establishment of contact between the San Diego Minutemen Group and a

Minutemen cell or organization at Santa Ana, California, which was previously unknown to the San Diego group. Informant stated plans were made for mutual cooperation on activities of the two groups.

Prior to 4/15/70, informant attended several planning meetings of the CMC and the SMC and was able to provide advance information on the anti-Vietnam war demonstration which took place in San Diego on 4/15/70. During this demonstration, informant provided photographic coverage and was helpful in establishing the presence of a number of known militants at the demonstration.

Informant has also provided coverage of anti-war rallies and demonstrations sponsored by the MDM at San Diego on 4/18/70 and at Oceanside, California, on 5/16/70; anti-war rallies at San Diego sponsored by CMC and SMC on 5/9/70; a teach-in and rally at San Diego State College on 5/18/70 sponsored by Tuesday the Ninth Committee, a militant organization at that school opposed to white racism and political oppression.

On 5/1/70, informant made a pretext visit to an individual named MORRIS KOMINSKI at Elsinore, California. Informant described KOMINSKI as a person who formerly moved in high levels of federal and local government and said he learned KOMINSKI is soon to have published a book in two volumes and in excess of 2,000 pages on the history of facism in the United States. Informant also learned KOMINSKI is sympathetic to the San Diego Street Journal and its publishers and has provided that paper with large quantities of information regarding political and business activities of well known individuals in the San Diego area, some of which information has appeared in subsequent issues of the paper.

// In addition to the foregoing, informant has provided large quantities of information regarding activities of right wing individuals and Minutemen members in the San Diego area.



*Handwritten signature/initials*

SAC, San Diego (170-286)

12/8/70

Director, FBI ( 137-17222 )

Attention: Voucher-Statistical Section

1 - Mr. R. L. Ridgeway

SD 1155-R REC-94 EX-106  
INFORMATION

Reurlet dated 11/27/70.

Authority is granted to designate captioned individual a Bureau-approved PSI and to proceed to develop source as a security informant in accordance with instructions set forth in Section 107, Volume IV, Manual of Instructions.

Authority is granted to designate captioned individual as a  probationary racial informant  ghetto probationary racial informant in accordance with instructions set out in Section 130, Volume IV, Manual of Instructions.

Authority is granted to pay captioned informant an amount up to \$ 250 per  month  week for services rendered on a c.o.d. basis, and up to \$ 100 per  month  week for expenses actually incurred for a period of 6 months  weeks effective 12/1/70. You should continue to maintain contact with informant and follow appropriate instructions in the Manual of Instructions.

Advise captioned informant that the Bureau is not concerned with the legitimate activities of the college or university or of its students. Do not contact informant on the campus.

MAILED 12  
DEC 13 1970  
COMM-FBI

Bufiles disclose no pertinent information regarding  captioned source  immediate relatives of source

Concerning your payments to this informant and all informants, you are reminded that payments must be commensurate with the value of the information received; that payments are to be made only for actual expenses incurred in connection with obtaining information for the FBI. In addition, payments should be made in such a manner that the informant clearly understands he is not being paid on a salary basis but rather on a c.o.d. basis.

Make certain informant understands cooperation with Bureau is strictly voluntary and that this cooperation must be maintained on a confidential basis at all times. Impress upon informant that informant is not Bureau employee. Exercise caution in your contacts with informant to make certain informant is not a plant.

- Tolson \_\_\_\_\_
- Sullivan \_\_\_\_\_
- Mohr \_\_\_\_\_
- Bishop \_\_\_\_\_
- Brennan \_\_\_\_\_
- Callahan \_\_\_\_\_
- Casper \_\_\_\_\_
- Conrad \_\_\_\_\_
- Felt \_\_\_\_\_
- Gale \_\_\_\_\_
- Rosen \_\_\_\_\_
- Tavel \_\_\_\_\_
- Walters \_\_\_\_\_
- Soyars \_\_\_\_\_
- Tele. Room \_\_\_\_\_
- Holmes \_\_\_\_\_

RLR:rmm (4)

SEE NOTE PAGE TWO

DEC 16 1970 363

*Handwritten signatures and initials: CMA, wes, Gary, RUC*

Letter to SAC, San Diego  
RE: SD 1155-R  
137-17222

NOTE:

The above is a continuation of previously authorized payment levels. Informant is a member of the Minutemen in San Diego on which he furnishes information. In addition, he furnishes reports on the activities of the Student Mobilization Committee and the San Diego Citizens Mobilization Committee. During the past payment period he submitted 95 reports which included coverage on 30 to 40 Minutemen followers and related right wing oriented individuals. Ninety-five percent of the information furnished was verified through other sources. During past payment period informant attended meetings and demonstrations of several antiwar and new left oriented extremist groups including travel to Los Angeles to cover the Disneyland invasion by the Youth International Party. Informant is the sole source of information on Minutemen activities in the San Diego area.

UNITED STATES GOVERNMENT

# Memorandum

TO : DIRECTOR, FBI(137-17222) DATE: 11/27/70

FROM : SAC, SAN DIEGO (170-286) (P)

SUBJECT:

CONF. INET.  
SD 1155-R

Re: RACIAL OR SECURITY INFORMANT PROGRESS/JUSTIFICATION LETTER

I.  (a) I recommend that authority be granted to continue captioned informant for a period of \_\_\_\_\_ months effective \_\_\_\_\_ and that he continue to be paid under the authority of the Special Agent in Charge, UACB.

(b) I recommend that authority be granted to pay captioned informant an amount up to \$ 250 per  month  week for services rendered on a c.o.d. basis, and up to \$ 100 per  month  week for expenses actually incurred for a period of six  months  weeks effective 12/1/70.  
(If increase, furnish full justification under "Miscellaneous.")

II. Membership: Informant is a member of the Minutemen (MM) Organization in San Diego, California.

Amount paid for services and expenses:

(See page 1-A)

Number of activities and persons on whom coverage is provided:

Informant reports regularly on activities of 30 to 40 individuals associated with the MM organization and related right wing groups in the San Diego, California, area. He continues to be employed by the San Diego City Fire Department which employment affords him considerable free time which he can use to observe and report on activities of many radical and militant individuals and organizations on and off college campuses in the San Diego area. Informant has attended planning meetings and demonstrations of various anti-war and militant groups and voluntarily traveled to Los Angeles, California, to observe an attempted invasion of Disneyland by individuals supporting the Youth International Party (yippies).

Number of statements (written and oral) submitted: 94 137-17222-10

Considered stable and reliable  Yes  No (Explain in "Miscellaneous.")

Indoctrinated against disclosure  Yes

Percentage of information verified 95% EX-106

All necessary action taken on information furnished  Yes  No (Explain in "Miscellaneous.")

- 2 - Bureau (RM)
- 1 - San Diego SLC:jam (3)

987.00  
10.50

Vertical stamp: CONFIDENTIAL

30

Vertical stamp: 12-8-70

REC-94

RACIAL INT. SECT.

SD 170-286

<u>Period</u>	<u>Services</u>	<u>Expenses</u>
6/1 - 6/30/70	\$200	\$39.47
7/1 - 7/31/70	210	36.70
8/1 - 8/31/70	215	29.44
9/1 - 9/30/70	230	26.39

- la -

Summary of information furnished: *(If more space needed, add addendum.)*

On 5/6/70, informant was in attendance at a rally of the Peace and Freedom Party (PFP) on the University of California at San Diego (UCSD) campus and, while there, obtained a number of copies, with names and addresses, of a PFP petition which was being circulated. The purpose of the petition was to impeach RONALD REAGAN, Governor of California. On 5/8/70, informant reported on plans being made by the San Diego Citizens Mobilization Committee (CMC) and the Student Mobilization Committee (SMC) at San Diego State College (SDSC) to protest the announcement of the United States' invasion of Cambodia.

On 5/9/70, informant was present at and observed the anti-war march and rally sponsored by CMC and SMC and furnished the names of a number of individuals responsible for, and participating in, the rally. Source also furnished photographic coverage of individuals participating in the rally and reported on attempts by an small number of right wing oriented individuals to disrupt the march.

(Cont'd on Page 3).

Miscellaneous: *(Furnish any change in residence and employment, steps being taken to advance informant, and any other pertinent information which should be brought to Bureau's attention.)*

Informant has been instructed to report on compensation received from the Bureau for services as income when filing his income tax return and he has agreed to comply.

Informant continues to be encouraged to take advantage of any opportunities to improve his coverage of activities of interest to the Bureau in the San Diego area. Due to the somewhat disorganized nature of the MM organization and related groups in the San Diego area because of the fugitive status and arrest of ROBERT BOLIVAR DE PUGH, National MM Leader, informant has been able to assume a position of leadership among many right wing oriented individuals in this area.

SD 170-286

On 5/27/70, source reported on the establishment of a new information center on the UCSD campus. The purpose of the new information center was to be a message, telephone, and contact center for student members of the radical or New Left community at the school.

On 6/3, and 6/8/70, source was instrumental in identifying GEORGE HOOVER as the person who had been actively and militantly associated with the MM organization in the San Diego area and was able to furnish information regarding HOOVER's associates and his place of residence.

On 7/2/70, source provided the names and addresses of three individuals who had contacted San Diego area underground newspaper for information regarding Weatherman activities and the establishment of a Weatherman group in San Diego. These names and addresses were obtained by members of the MM organization and made available to the source.

On 8/6/70, source traveled to Los Angeles, California, to observe an attempted invasion of the Disneyland Amusement Park by persons who had previously advertised themselves as being Yippies of the Youth International Party.

On 8/17/70, source was present at the White Whale, a restaurant and tavern in the San Diego area which caters to members of the New Left movement and the hippie establishment, and reported on activities there in connection with a fund raising benefit for the San Diego Street Journal, a San Diego area underground newspaper. Source reported that a large number of individuals were present and it appeared that a considerable amount of money had been raised.

On 9/2/70, informant reported information he had obtained indicating that plans were being made by individuals in the San Diego area for a large scale anti-Vietnam war demonstration to take place on 9/3/70 during the visit and State dinner of President NIXON and President ORDAZ of Mexico at Coronado, California.

On 9/3/70, source was present at activities and festivities surrounding the visit of Presidents NIXON and ORDAZ at Coronado, California, and furnished information regarding individuals he recognized as being militant members

SD 170-286

of the New Left movement and who were observed to have firearms in their vehicles.

On 8/27/70, source was in contact with former General WILLIAM LENLY of Coronado, California, who furnished source with extensive information regarding an organization known as American Volunteer Group (AVG) which LENLY described as being an underground military organization, the purpose of which is to take over the United States Government in the event it appears to be threatened either from within or without by Communists or other totalitarian organizations or governments.

During the months of September and October, 1970, source successfully penetrated Message Information Center (MIC), a message and telephone service established by members of the New Left movement in San Diego for the benefit of persons adhering to the New Left policy. Source was able to furnish a large volume of information concerning individuals connected with the MIC.

Informant is sole source of information in the MM activities in the San Diego area.

I - Mr. L. L. Anderson

SAC San Diego (170-286)

6/10/71

Director, FBI (137-17222 -) 9

Attention: Voucher-Statistical Section

SD 1155-R Informant  
RM - MINUTEMEN

Reurlet 6/4/71.  
 Authority is granted to designate captioned individual a Bureau-approved PSI and to proceed to develop source as a security informant in accordance with instructions set forth in Section 107, Volume IV, Manual of Instructions.

Authority is granted to designate captioned individual as a  probationary racial informant  ghetto probationary racial informant in accordance with instructions set out in Section 130, Volume IV, Manual of Instructions.

Authority is granted to pay captioned informant an amount up to \$ 250.00 per  month  week for services rendered on a c.o.d. basis, and up to \$ 100.00 per  month  week for expenses actually incurred for a period of six  months  weeks effective 6/1/71. You should continue to maintain contact with informant and follow appropriate instructions in the Manual of Instructions.

MAILED 7  
JUN 10 1971  
FBI

Advise captioned informant that the Bureau is not concerned with the legitimate activities of the college or university or of its students. Do not contact informant on the campus.

Bufiles disclose no pertinent information regarding  captioned source  immediate relatives of source

Concerning your payments to this informant and all informants, you are reminded that payments must be commensurate with the value of the information received; that payments are to be made only for actual expenses incurred in connection with obtaining information for the FBI. In addition, payments should be made in such a manner that the informant clearly understands he is not being paid on a salary basis but rather on a c.o.d. basis.

Make certain informant understands cooperation with Bureau is strictly voluntary and that this cooperation must be maintained on a confidential basis at all times. Impress upon informant that informant is not Bureau employee. Exercise caution in your contacts with informant to make certain informant is not a plant.

In the future, insure that Progress Letter is submitted at least two weeks before expiration date.

LLA:co (4)

SEE NOTE PAGE TWO

- Tolson \_\_\_\_\_
- Mullivan \_\_\_\_\_
- Mohr \_\_\_\_\_
- Bishop \_\_\_\_\_
- Brennan, C.D. \_\_\_\_\_
- Callahan \_\_\_\_\_
- Casper \_\_\_\_\_
- Conrad \_\_\_\_\_
- Malby \_\_\_\_\_
- Melt \_\_\_\_\_
- Rale \_\_\_\_\_
- Rosen \_\_\_\_\_
- Savel \_\_\_\_\_
- Talters \_\_\_\_\_
- Woyars \_\_\_\_\_
- Tele. Room \_\_\_\_\_
- Holmes \_\_\_\_\_
- Gandy \_\_\_\_\_

JUN 17 1971

ci 3/2



Letter to San Diego  
Re: SD 1155-R  
137-17222

NOTE:

The above is continuation of previously authorized payment levels. Informant is member of Minutemen organization in San Diego, California, and is principle informant reporting on this and other right wing groups in San Diego area. He has also furnished considerable information concerning New Left activity and antilaw enforcement demonstrations. Specifically, he has furnished information regarding Post Office boxes being opened under fictitious names, advance data regarding publishing of New Left underground newspapers, identities of individuals organizing and participating in "Stop the Pig" rally, identified newly appointed National White People's Party (NSWPP) official in San Diego area and information regarding surveillance of FBI radio facilities at Ramona, California, as well as selected Minutemen sabotage targets. He has furnished 83 reports involving 30-40 individuals, 95% of which have been verified.

UNITED STATES GOVERNMENT

# Memorandum

TO : DIRECTOR, FBI (137-17222)

DATE: 6/4/71

FROM : SAC, SAN DIEGO (170-286) (P)

SUBJECT: CONF. INFO. [redacted] informed

EXP. PROC. 30

Re: **RACIAL OR SECURITY INFORMANT PROGRESS/JUSTIFICATION LETTER**

- I.  (a) I recommend that authority be granted to continue captioned informant for a period of \_\_\_\_\_ months effective \_\_\_\_\_ and that he continue to be paid under the authority of the Special Agent in Charge, UACB.
- (b) I recommend that authority be granted to pay captioned informant an amount up to \$ 250 per  month  week for services rendered on a c.o.d. basis, and up to \$ 100 per  month  week for expenses actually incurred for a period of six  months  weeks effective 6/1/71.  
(If increase, furnish full justification under "Miscellaneous.")

II. Membership Informant is a member of the Minutemen (MM) Organization in San Diego, California.

Amount paid for services and expenses:  
(See page 1-A)

Number of activities and persons on whom coverage is provided:

Informant reports regularly on activities of 30 to 40 individuals associated with the MM Organization and related right wing groups in the San Diego, California area. He continues to be employed by the San Diego City Fire Department which employment affords him considerable free time which he can use to observe and report on activities of many radical and militant individuals and organizations on and off college campuses in the San Diego area.

6/10/71  
 L.A.C. d.  
 The copies were reviewed  
 who had been reviewed on 6/2/71

0-17 SD 6/8/71  
 re: omission of  
 character. JMW/788

ST-110

REC-31

137-17222-

9

JUN 10 1971

Number of statements (written and oral) submitted: 83

Considered stable and reliable  Yes  No (Explain in "Miscellaneous.")

Indoctrinated against disclosure  Yes

Percentage of information verified 95%

All necessary action taken on information furnished  Yes  No (Explain in "Miscellaneous.")

RACIAL INT. SECT.

- ② - Bureau (RM)
- 1 - San Diego

SLC/lse

SD 170-286

<u>Period</u>	<u>Services</u>	<u>Expenses</u>
10/1 - 10/31/70	\$205	\$31.61
11/1 - 11/30/70	210	51.49
12/1 - 12/31/70	225	23.97
1/1 - 1/31/71	235	34.24
2/1 - 2/28/71	230	47.51

- la -

Summary of information furnished: *(If more space needed, add addendum.)*

In September 1970, source advised of the opening of several Post Office boxes by the MM organization and furnished the number of the Post Office boxes and the fictitious names under which they were rented.

In September, source also provided advance information on efforts to republish the new left underground newspaper named Street Journal and also on plans on the part of persons associated with the Street Journal to hold an anti-law enforcement demonstration named "Stop the Pig."

During October 1970, source provided coverage of the "Stop the Pig" rally, furnishing information regarding activities and identities of speakers and participants. Furthermore, source provided similar information and coverage for an anti-war demonstration held in San Diego on 10/31/70.

(Cont-d on Page 3)

Miscellaneous: *(Furnish any change in residence and employment, steps being taken to advance informant, and any other pertinent information which should be brought to Bureau's attention.)*

Informant has been instructed to report on compensation received from the Bureau for services as income when filing his income tax return and he has agreed to comply.

Informant continues to be encouraged to take advantage of any opportunities to improve his coverage of activities of interest to the Bureau in the San Diego area. Due to the somewhat disorganized nature of the MM organization and related groups in the San Diego area because of the fugitive status and arrest of ROBERT BOLIVAR DE PUGH, National MM leader, informant has been able to assume a position of leadership among many right wing oriented individuals in this area.

SD 170-286

During October 1970, source was instrumental in identifying MARGERY MC NICKLES as an associate of the MM organization and advised of her relationship with ROBERT BOLIVAR DE PUGH and with the Patriotic Party

In December 1970, source was instrumental in identifying GERALD L. SMITH as leader of the local National Socialist White People's Party.

In January 1971, source furnished information regarding surveillance of Bureau radio facilities at Ramona, California and MM plans to compile a list of selected targets for sabotage in the event of a totalitarian takeover of the United States. In addition, source furnished printed information regarding literature and other materials emanating from what was purported to be a new MM organization headquartered at Elgin, Illinois.

Source was provided information regarding possible efforts on the part of LOU CONDE, an MM affiliate to arm a seagoing vessel for the purpose of providing protection for American tuna boats against ships of various Latin-American countries while fishing in waters off those countries.

During February, March, April and May, source has provided information and coverage of several anti-war rallies on the San Diego State College campus and in the San Diego area. Furthermore, he has furnished information concerning continuing efforts on the part of right wing sympathizers in the Southern California area to rebuild the MM organization or to establish a new organization similar to the old one.

During the preceding six months, source has identified several individuals as being members or sympathizers of the MM organization and has provided extensive information regarding their activities including their dealings in firearms and explosives.

Informant is sole source of information in MM activities in the San Diego area.

FBI

Date: 7/27/71

Transmit the following in \_\_\_\_\_  
(Type in plaintext or code)

Via IRTEL \_\_\_\_\_  
(Priority)

TO: DIRECTOR, FBI  
FROM: SAC, SAN DIEGO (170-236) (P)  
SUBJECT: SD 1155-R  
RE: MINUTEMEN

3  
J.C.H.

Re San Diego teletype to the Bureau dated 7/23/71 and Bureau teletype to San Diego dated 7/24/71.

Enclosed for the Bureau are the original and six copies of an LHM entitled "JERRY LYNN DAVIS, also known as Sam Davis; EUGENE BROVEN," dated 7/27/71 at San Diego, San Diego file 174-428.

For the information of the Bureau, SD 1155-R for reasons of his and his family's personal safety, has petitioned for relocation. Enclosed LHM sets forth in summary form the basis for his request. It appears from several years of association with the Minutemen organization and members and other individuals associated with this group, particularly JERRY LYNN DAVIS, the subject has a legitimate concern that injury or death may occur to him and his family as a result of his services performed in behalf of the government.

It is noted that the informant is willing to leave the home which he owns and a civil service job with the City of San Diego which pays him in excess of \$1,000 per month, in order to secure the safety of his family.

Informant has not asked for other employment and estimates that cost of relocation would amount to approximately \$1500 to \$2600.

REC-2 137-17222-10

- 4 - Bureau (Enc. 7) (RM)
- (2 - 137-17222)
- 3 - San Diego (Enc. 7)
- (2 - 170-236)
- (1 - 174-428)

EX-104

16 JUL 29 1971

53(7) AUG 18 1971

Approved: \_\_\_\_\_  
Special Agent in Charge

Sent \_\_\_\_\_ M Per \_\_\_\_\_

1-150 3696A  
1-AD  
1-ATTN: by RS  
1-ADG. by Action. by RS  
1-EDG. by [unclear] 8/5/71

UNREC COPY AND COPIES OF ENCL FILED IN 11-2163

SD 170-286

In accordance with the court decision set forth in S.C Letter 70-12 dated 3/16/70, it would appear that the Government does have an obligation to relocate the informant. It would also appear that inasmuch as the informant's usefulness has been effectively terminated as the result of a case falling within the jurisdiction of the Alcohol, Tobacco and Firearms Division that either that agency or the U.S. Department of Justice should bear the expenses for such a relocation.

However, in the event neither ATF nor the Department will accept the responsibility for providing such relocation to the informant, the FBI has a moral obligation to do so. This follows by virtue of the fact that SD 1155-R was requested to serve as an informant by the Bureau and that he has performed faithfully in this capacity for four and one-half years.

~~The Bureau is requested to contact the Department of Justice and Washington, D.C. headquarters of ATF to determine if they will provide necessary expenses to relocate the informant. If such a request is denied by these offices, it is then recommended that the Bureau take upon itself the government's obligation to relocate the informant at a place of safety to him and his family.~~

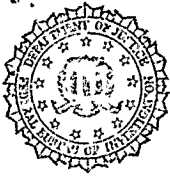

UNITED STATES DEPARTMENT OF JUSTICE

FEDERAL BUREAU OF INVESTIGATION

San Diego, California

July 27, 1971

In Reply, Please Refer to  
File No.

JERRY LYNN DAVIS,  
Also Known As Sam Davis;  
EUGENE BROWN

The following is information in addition to our communications dated June 29, 1971 and July 7, 1971.

For the past four and one-half years, the San Diego Division of the Federal Bureau of Investigation has been operating an informant who has been highly successful in penetrating the Minuteman organization in the San Diego, California, area. In this capacity, informant has performed an outstanding service to the government and to the nation in acquiring and making available a large volume of information regarding the activities of the Minuteman organization and related groups. In addition, due to the nature of his employment, informant has been successfully targeted against other unrelated activities and has provided coverage and penetration of a number of New Left oriented groups and demonstrations. The scope of information provided by the source has often extended beyond the immediate San Diego area to other parts of the nation. He also has been instrumental in identifying and following the activities of many individuals who are of interest to the Federal Bureau of Investigation. Informant has at all times been found to be stable, trustworthy and reliable.

The Minutemen is a paramilitant group organized in June, 1960, by ROBERT B. DE PUGH in Norborne, Missouri, as a resistance to the spread of communism in the United States by use of guerrilla tactics. DE PUGH is currently incarcerated in a Federal penitentiary for violation of the Federal Firearms Act.

On June 23, 1971, source advised that on the previous Saturday, June 19, 1971, he was in attendance at a gun show held at Pasadena, California. Accompanying him to the show

137-17222-10

ENCLOSURE



JERRY LYNN DAVIS, ALSO KNOWN AS  
SEM DAVIS; EUGENE BROWN

was JERRY LYNN DAVIS, known to the informant for several years as a member of the Minuteman organization. At the show, contact was made with a third party, EUGENE BROWN, a reporter for the "Anaheim Bulletin" and an associate of members of the Minuteman organization in the Los Angeles, California, area, if not a member himself.

During the show, several arrests were made, some by the Alcohol, Tobacco and Firearms Division (ATFD). Because of these arrests and long held attitudes on the part of DAVIS and BROWN that, although Communism and Socialism pose threats to their security, the government of this country is their real enemy, a decision was reached by BROWN and DAVIS that retaliation should be made against the government by bombing ATFD and the Internal Revenue Service (IRS) offices. Plans were made for the three to meet again the following Saturday evening at a motel in or near the City of El Cajon, California, the exact time and place not then specified. At this meeting, final plans would be made for the bombing and specific targets selected, one in the Los Angeles, California, area which BROWN would handle, and one at San Diego, California, which DAVIS would handle.

In apparent furtherance of this scheme, DAVIS delivered to the informant on two occasions, two metal ammunition cans for storage and safekeeping. These cans were found to contain several pounds of TNT explosives, 18 hand grenade fuse assemblies, two rifle grenades, approximately 275 blasting caps of various sizes and types, a military hand illuminating grenade, a number of parts for converting M-1 and M-15 rifles to the corresponding M-2 and M-16 fully automatic weapons and other miscellaneous items. This material was turned over to the Federal Bureau of Investigation by the informant on June 25, 1971, and was in turn given to ATFD for possible use as evidence by that agency.

Assistant U.S. Attorney STEPHEN G. NELSON, then Chief of the Complaint Section, U.S. Attorney's Office, San Diego, California, was contacted on June 25, 1971, and stated that, as then developed, the facts in this case did not represent a prosecutable violation and that additional

JERRY LYNN DAVIS, ALSO KNOWN AS  
SAM DAVIS; EUGENE BROWN

evidence, such as photographs and tape recordings substantiating the conspiratorial meeting to take place on the evening of June 26, 1971, would be necessary. For as yet unexplained reasons, subject BROWN did not appear for the meeting on the evening of June 26, 1971, and has not subsequently been seen or heard from by either the informant or subject DAVIS. Informant has advised that to his knowledge no additional plans have been made or work done toward carrying out the above-described bombings.

On July 20, 1971, subject DAVIS requested that the hand illuminating grenade included in the explosives given by him to the informant, be returned to him on the weekend of July 24 - 25, 1971, indicating he had some use for the weapon but not elaborating further on the matter.

On July 23, 1971, following consultation with Assistant U.S. Attorney ROBERT P. RISSO, newly appointed Chief of the Criminal Complaint Section, and with representatives of the San Diego AFD office, authorization was granted by RISSO and by AFD for the hand illuminating grenade to be returned to DAVIS through the informant. This was only to be done on the condition that the illuminating grenade was effectively deactivated.

At this same time, RISSO stated he saw no possible way to obtain successful prosecution of DAVIS in this matter. Furthermore, he advised that he would in no way authorize return of the remaining items of explosives to DAVIS.

On July 23, and 26, 1971, the source pointed out that DAVIS' request that the hand illuminating grenade be returned to him points up the fact that his request for other parts or all of the items entrusted by him to the informant is imminent. Because of his association with DAVIS, whom the informant believes to be bordering on being mentally irrational, informant is convinced that for whatever reason, when it becomes necessary for him to tell DAVIS he cannot return these materials to him it will become obvious to DAVIS that the informant is exactly that or has in some other way betrayed him, and that DAVIS will then take reprisal of a violent nature against the informant and his family.

JERRY LINDI DAVIS, ALSO KNOWN AS  
SAM DAVIS; EUGENIE BROWN

Inasmuch as the explosives cannot be returned, the informant has petitioned that he and his family be relocated in some other part of the country out of DAVIS' reach. To this end, informant is willing to leave his home and an excellent employment but does not ask for another job. Informant has stated a personal preference for relocation at Boise, Idaho, which he feels would be a safe location as it is not a place to which he would be expected to go.

On July 27, 1971, Special Investigator STEVE LOGAN, ATFD, San Diego, was contacted regarding the matter of relocating the informant. LOGAN stated that he was not in a position to make a determination on a question of that nature but stated he did not believe that ATFD would accept such a responsibility unless the informant had served as a witness in an ATFD prosecution.

This document contains neither recommendations nor conclusions of the FBI. It is the property of the FBI and is loaned to your agency; it and its contents are not to be distributed outside your agency.

FBI

Date: 8/2/71

Transmit the following in \_\_\_\_\_  
(Type in plaintext or code)

Via AIRTEL AIR MAIL - REGISTERED  
(Priority)

TO: DIRECTOR, FBI (137-17222)  
FROM: SAC, SAN DIEGO (170-286) (P)  
CONF. INFO

SD 1155-R  
RM-MINUTEMEN

*Informant*

Re San Diego airtel to the Bureau dated 7/27/71, with enclosed LHM entitled "JERRY LYNN DAVIS, aka.; EUGENE BROWN, BOMBING MATTER."

Enclosed for the Bureau are the original and six copies of a Letterhead Memorandum entitled "JERRY LYNN DAVIS; EUGENE BROWN," which is dated August 2, 1971, at San Diego, California, SD file 174-428.

Enclosed LHM sets forth details of a telephone call made by Mr. and Mrs. CHARLES GODFREY, 4433 Maple, La Mesa, California, on 7/28/71 to Field Supervisor ANTHONY J. MALONEY, JR. Also reflected in the LHM is the results of contact by SA STEVEN L. CHRISTENSEN with SD 1155-R on 7/29/71.

*Informant*

ENCLOSURE

- 4 - Bureau (Encs. 7)(RM) EX-105
  - (2) - 137-17222
  - (2 - 174-JERRY LYNN DAVIS, aka; EUGENE BROWN, BOMBING MATTER)

- 3 - San Diego
  - (2 - 170-286)
  - (1 - 174-428)

SLC/dfm/mt  
(7)

*Ice detached by Klan Unit*

REC-26/ 37-17222-11

AUG 6 1971

*Handwritten signatures and initials*

51 AUG 10 1971

Approved: \_\_\_\_\_  
Special Agent in Charge

Sent \_\_\_\_\_ M Per \_\_\_\_\_

*1-ATFD  
1-CD 644-F  
1-SD 1155-R  
8/11/71  
CPL/SLC*

UNREC COPY AND COPY OF ENCL FILED IN 171-2183

SD 170-286

*In Form 100*

For the Bureau's information, it is noted that the parents of SD 1155-R have been aware of his activities in behalf of the Bureau, inasmuch as informant counselled with them at the time he was initially approached with regard to performing services for the FBI. Over the years, through casual contact, informant's parents have become fairly well acquainted with many of the individuals with whom the informant has associated in his capacity as a source of information, including JERRY LYNN DAVIS. Based on their knowledge of these individuals they have expressed considerable concern, not only for the safety of their son and his family, but also for other members of their own family.

No assurances with regard to relocation or securing employment for the informant have been made either to the informant or his parents.

With regard to the remark of the informant's father as to his "friends" in Washington, D.C., the inference of this remark was interpreted as being that if the FBI did not help SD 1155-R as to relocation, Mr. GODFREY might seek the assistance of his "friends" in Washington. This remark was not further pursued with Mr. GODFREY.



UNITED STATES DEPARTMENT OF JUSTICE  
FEDERAL BUREAU OF INVESTIGATION

San Diego, California  
August 2, 1971

In Reply, Please Refer to  
File No.

JERRY LYNN DAVIS;  
EUGENE BROWN

The following is information in addition to our communication dated July 27, 1971:

On July 26, 1971, the informant who has furnished the previous information in this case, was approached on the subject of relieving him of custody of certain explosive materials previously furnished to him by subject DAVIS, by the use of a search warrant for the explosives at his home. The search warrant, it was felt, would serve the purpose of explaining to DAVIS why this informant could not produce the explosives. After lengthy consideration, the informant declined to accept this suggestion as a workable solution to the problem. The informant is convinced that regardless of the reason given, when he advises DAVIS he no longer has possession of the explosives, DAVIS's anger will cause him to become irrational to the point that he would commit some act or acts of violence against the informant or his family. Informant continued to be of the opinion that due to the fact the explosives could not be made available for return to DAVIS, the only safe course of action for him and his family would be relocation in an area where the informant and his family would be out of DAVIS's reach.

On July 28, 1971, the informant's parents telephonically contacted the San Diego Division of the FBI. They advised that based on their knowledge of JERRY LYNN DAVIS, and other individuals with whom their son had been associating, they felt his concern for the personal safety of both himself and his family was completely justified. The parents advised that they contemplated moving to the state of Hawaii in the near future for reasons of health.

137-17222-11

JERRY LYNN DAVIS;  
EUGENE BROWN

In addition, the parents indicated they were not satisfied solely with the possibility of the informant's relocation to Boise, Idaho, and felt that in addition to relocation, the Federal Bureau of Investigation should secure a job for the informant at the place of relocation comparable to the \$12,000 a year job he presently holds at San Diego. The parents advised they had suggested to informant the possibility of his relocation in Hawaii, as they felt there should be an abundance of employment opportunities with the U.S. Government in that state and that the Federal Bureau of Investigation should be able to get one for their son without too much difficulty.

During this conversation, the informant's father advised he (the father) has friends in Washington, D.C., and that if it appeared help might be necessary in obtaining authorization for relocation and the securing of employment for the informant, he would be glad to contact these people for any assistance they might be able to render.

On July 29, 1971, the informant was recontacted at which time he stated he had continued to give the matter of relocation considerable thought. He pointed out that his parents have, for some time, been trying to convince him of the desirability of moving to the state of Hawaii. He explained that his parents have resided and visited in that state several times, and are contemplating moving there permanently in the near future for health and business reasons. Informant advised he personally continues to feel that relocation at Boise, Idaho, would be more advantageous to him. He stated he would appreciate assistance from the Federal Bureau of Investigation in finding employment there.

Informant further advised that the home in which he lives at San Diego is being purchased through a Federal Housing Administration (FHA) loan and has a current market value of approximately \$20,000. He said that subsequent to making the original estimate of \$1,500 to \$2,000, as the cost of relocating him to another place, the points required for liquidating FHA loans have raised from 2 to 10.

JERRY LYNN DAVIS;  
EUGENE BROWN

He said that this meant that while originally it would have cost him only \$400 to pay off his FHA loan, he is now faced with the problem of paying \$2,000 to do the same thing. The informant feels that it will now cost him approximately \$3,000 to \$3,500 to relocate at Boise, Idaho.

This document contains neither recommendations nor conclusions of the FBI. It is the property of the FBI and is loaned to your agency; it and its contents are not to be distributed outside your agency.



1 - Mr. F. A. Tansey

SAC, San Diego (1705-200)

1/4/72

Director, FBI REC 20 ST-106 12  
137-17222

Attention: Voucher-Statistical Section

*Saw*  
*[Signature]*

**SD 1155-E** *informant*

Reurlet 12/23/71.

Authority is granted to designate captioned individual a Bureau-approved PSI and to proceed to develop source as a security informant in accordance with instructions set forth in Section 107, Volume IV, Manual of Instructions.

Authority is granted to designate captioned individual as a  probationary extremist informant  ghetto extremist informant in accordance with instructions set out in Section 130, Volume IV, Manual of Instructions.

Authority is granted to pay captioned informant an amount up to \$250.00 per  month  week for services rendered on a c.o.d. basis, and up to \$100.00 per  month  week for expenses actually incurred for a period of 6  months  weeks effective 12/1/71. You should continue to maintain contact with informant and follow appropriate instructions in the Manual of Instructions.

MAILED 23  
JAN 4 - 1972  
FBI

Advise captioned informant that the Bureau is not concerned with the legitimate activities of the college or university or of its students. Do not contact informant on the campus.

Bufiles disclose no pertinent information regarding  captioned source  immediate relatives of source

Concerning your payments to this informant and all informants, you are reminded that payments must be commensurate with the value of the information received; that payments are to be made only for actual expenses incurred in connection with obtaining information for the FBI. In addition, payments should be made in such a manner that the informant clearly understands he is not being paid on a salary basis but rather on a c.o.d. basis.

Make certain informant understands cooperation with Bureau is strictly voluntary and that this cooperation must be maintained on a confidential basis at all times. Impress upon informant that informant is not Bureau employee. Exercise caution in your contacts with informant to make certain informant is not a plant.

- Tolson \_\_\_\_\_
- Felt \_\_\_\_\_
- Rosen \_\_\_\_\_
- Mohr \_\_\_\_\_
- Bishop \_\_\_\_\_
- Miller, E.S. \_\_\_\_\_
- Callahan \_\_\_\_\_
- Casper \_\_\_\_\_
- Conrad \_\_\_\_\_
- Dalbey \_\_\_\_\_
- Cleveland \_\_\_\_\_
- Ponder \_\_\_\_\_
- Bates \_\_\_\_\_
- Tavel \_\_\_\_\_
- Walters \_\_\_\_\_
- Soyars \_\_\_\_\_
- Telo. Room \_\_\_\_\_
- Holmes \_\_\_\_\_
- Gandy \_\_\_\_\_

FAT:dls  
(4)

SEE NOTE PAGE TWO

MAIL ROOM  TELETYPE UNIT

*muel*  
*ReB*

RECEIVED

*1/15/72*

*JCD*  
*FAT*  
*DEM/WAIS*

JAN 15 1972

Letter to San Diego  
Re: SD 1155-E  
137-17222

NOTE:

The above is continuation of previously authorized payment levels. Informant is member of Minutemen organization in San Diego, California, and is principal informant reporting on this and other right-wing groups in San Diego area. He has also furnished considerable information concerning New Left activity and anti-law enforcement demonstrations. Specifically he has provided information identifying approximately 15 individuals associated with known Minutemen or related right-wing supporters; data regarding alleged dealings in firearms and other items of interest on part of these individuals; coverage of a plot to bomb offices of the Alcohol, Tobacco, and Firearms Division in Southern California in retaliation for arrests made by that office during a gun show held at Pasadena, California, in June, 1971; information regarding leaders and members of the San Diego Branch of the National Socialist White People's Party (NSWPP); and, information concerning formation of a new group in San Diego known as the "Secret Army Organization." He has also identified several persons involved in New Left oriented activities in the San Diego area. Informant provided 76 reports involving 30-40 individuals, 95% of which has been verified. Requested payments fully justified.

UNITED STATES GOVERNMENT

# Memorandum

TO : DIRECTOR, FBI (137-17222)

DATE: 12/23/71

FROM : SAC, SAN DIEGO (170-286) (P)

SUBJECT: CONF. INFT.  
SD 1155-E informant  
E - MM

Re: **EXTREMIST OR SECURITY INFORMANT PROGRESS/JUSTIFICATION LETTER**

I.  (a) I recommend that authority be granted to continue captioned informant for a period of \_\_\_\_\_ months effective \_\_\_\_\_ and that he continue to be paid under the authority of the Special Agent in Charge, UACB.

(b) I recommend that authority be granted to pay captioned informant an amount up to \$ 250 per  month  week for services rendered on a c.o.d. basis, and up to \$ 100 per  month  week for expenses actually incurred for a period of six  months  weeks effective 12/1/71.  
(If increase, furnish full justification under "Miscellaneous.")

II. Membership: Informant is a member of the Minutemen (MM) Organization in San Diego, California, and also of a new formed organization known as the Secret Army Organization.  
Amount paid for services and expenses:

(See page 1-A)

Number of activities and persons on whom coverage is provided:

Informant reports regularly on activities of 30 to 40 individuals associated with the MM Organization and related right wing groups in the San Diego, California area. He continues to be employed by the San Diego City Fire Department which employment affords him considerable free time which he can use to observe and report on activities of many radical and militant individuals and organizations on and off college campuses in the San Diego area.

Number of statements (written and oral) submitted: 76

Considered stable and reliable  Yes  No (Explain in "Miscellaneous.")

Indoctrinated against disclosure  Yes

Percentage of information verified 95%

All necessary action taken on information furnished  Yes  No (Explain in "Miscellaneous.")

2 - Bureau (RM)  
1 - San Diego

SIC/crw

12/29/71... requested re enclosed

#1330  
#17

4P #25/82

bet to SD  
14/72  
12/30/72  
PH:dlb

38

ST-106 REC 20 137-17222-12  
1-4-72  
25 DEC 27 1971

EXT. INT. SEC.

SD 170-286

<u>PERIOD</u>	<u>SERVICES</u>	<u>EXPENSES</u>
6/1 - 30/71	\$240.00	\$51.25
7/1 - 30/71	\$250.00	\$96.00
8/1 - 31/71	\$205.00	\$30.12
9/1 - 30/71	\$205.00	\$25.55
10/1 - 29/71	\$210.00	\$21.40
11/1 - 30/71	\$220.00	\$27.50

- la -

Summary of information furnished: *(If more space needed, add addendum.)*

On several occasions during the period June, 1971 to November, 1971, informant has provided information containing pertinent details regarding the disappearance and probable death of TROY HAUGHTON, former West Coast leader of the MM Organization. In this regard, informant has been able to independently substantiate information received by other field divisions concerning HAUGHTON's probable death.

In addition, during the same period of time, informant has identified approximately 15 individuals, who are associated with known MM or related right wing supporters and sympathizers. He has furnished a large volume of information regarding alleged dealings in firearms and other items of interest on the part of these individuals.

In June, July, and August, 1971, informant provided considerable coverage of a plot on the part of JERRY LYNN DAVIS, a known MM leader in the San Diego area, and EUGENE BROWN, a right wing sympathizer in the Los Angeles, California area to bomb offices of the Alcohol, Tobacco, and Firearms Division in Southern California in retaliation for arrests made by that office during a gun show held at Pasadena, California in June, 1971.

Miscellaneous: *(Furnish steps being taken to advance informant, and any other pertinent information which should be brought to Bureau's attention.)* (Cont'd Page 3)

Informant has been instructed to report on compensation received from the Bureau for services as income when filing his income tax return and he has agreed to comply.

Informant has been encouraged to take advantage of any opportunities to improve his coverage of activities of interest to the Bureau in the San Diego area. Through his close association with individuals involved in extremist activities in the San Diego area, he has been able to achieve a leadership position in these activities, particularly in the newly formed Secret Army Organization.

SD 170-286

During the period June to November, 1971, source has also provided information relative to the San Diego Branch of the National Socialist White People's Party, (NSWPP) identified some leaders and members of this group, and provided details regarding its relationships with similar groups at Los Angeles, California. Source has furnished the location of the new NSWPP Headquarters in the San Diego area. In October of 1971, source provided information regarding the formation of a new organization in San Diego known as the Secret Army Organization which was created by JERRY LYNN DAVIS and others to provide a new image for MM type activities in the area. Source has provided information regarding contact of leaders of this group with other individuals in the States of Arizona, Nevada, and Washington in an effort to expand the organization into those states.

During the months of October and November, 1971, the source was instrumental in identifying several individuals involved in New Left oriented activities in the San Diego area through surveillance and by participating in some of these activities.

Informant is sole source of information in MM and related activities in the San Diego area.

FEDERAL BUREAU OF INVESTIGATION  
COMMUNICATIONS SECTION

*J.P.*  
TELETYPE

Mr. Tolson	_____
Mr. Felt	_____
Mr. Rosen	_____
Mr. Mohr	_____
Mr. Bishop	_____
Mr. Miller, ES	_____
Mr. Callahan	_____
Mr. Casper	_____
Mr. Conrad	_____
Mr. Dalbey	_____
Mr. Cleveland	_____
Mr. Fonder	_____
Mr. Bates	_____
Mr. Warkart	_____
Mr. Walters	_____
Mr. Soyars	_____
Tele. Room	_____
Miss Holmes	_____
Miss Gandy	_____

NR 16 SD CODE  
 947 PM NITEL 01-14-72 DDC  
 TO DIRECTOR 137-17222-  
 134-17222-  
 FROM SAN DIEGO 170-286 2P

CONF. INFO. *W. ROYMAN*

SD ONE ONE FIVE FIVE DASH E. EM - MM.  
1 1 5

*C. E. ...*

*P. ...*

*104*

*7*

RE SD TEL TO BU JANUARY THIRTEEN LAST.

ON JANUARY THIRTEEN LAST, INFORMATION AS SET FORTH IN RE TEL WAS FURNISHED ON A CONFIDENTIAL BASIS TO CAPTAIN KENNETH O'BRIEN, SAN DIEGO PD, BY SA'S STEVEN L. CHRISTENSEN AND EARL M. PETERSEN. INFORMANT'S IDENTITY WAS NOT DIVULGED DURING THE INTERVIEW. O'BRIEN WAS ADVISED THAT THIS INFORMATION WAS FURNISHED TO HIS DEPARTMENT FOR WHATEVER USE DEEMED APPROPRIATE. O'BRIEN REPLIED HE WOULD MAKE SUCH DISSEMINATION OF THIS INFORMATION AS APPEARED NECESSARY. HE ASSURED INTERVIEWING AGENTS THAT THIS INFORMATION WOULD BE MAINTAINED IN THE STRICTEST OF CONFIDENCE. CAPTAIN O'BRIEN STATED THAT IN HIS PERSONAL OPINION, FROM KNOWLEDGE HE THEN POSSESSED OF THE CASE INVOLVING THE

EX-101

REC-32 137-17222-13

JAN 17 1972

END PAGE ONE

*5-12/15/91W*  
*Hulje*

*F23*

PAGE TWO

SHOOTING INCIDENT, HE DID NOT BELIEVE THAT THE POLICE DEPARTMENT WOULD BE ABLE TO ACHIEVE A SUCCESSFUL PROSECUTION IN THIS MATTER EVEN IF SD ONE ONE FIVE FIVE DASH E <sup>Informant</sup> WAS MADE AVAILABLE TO TESTIFY. HE SAID IN VIEW OF THE FOREGOING, IT WOULD BE WASTEFUL TO EXPOSE THE INFORMANT AT THIS TIME, ESPECIALLY IN VIEW OF THE URGENT NEED FOR THE TYPE OF COVERAGE INFORMANT WILL BE ABLE TO PROVIDE DURING THE FORTHCOMING SEVENTYTWO REPUBLICAN NATIONAL CONVENTION.

SAN DIEGO WILL ADVISE THE BUREAU IF ADDITIONAL PERTINENT DEVELOPMENTS ARISE IN THIS MATTER.

PENDING.

END



CODE

TELETYPE

NRML

EX-104

FEDERAL BUREAU OF INVESTIGATION  
COMMUNICATIONS SECTION

1/14/72

TO SAC SAN DIEGO (170-286)

FROM DIRECTOR FBI (154-17222)

JAN 14 1972

TELETYPE

- 1 - Mr. A. Rosen
- 1 - Mr. E.S. Miller
- 1 - Mr. Shackelford
- 1 - Mr. G.C. Moore
- 1 - Mr. L.G. Brockman
- 1 - Mr. J.G. Deegan
- 1 - Mr. R.L. Ridgeway

[SD ONE ONE FIVE FIVE] - E. Informant

REURTEL JANUARY THIRTEEN, NINETEEN SEVENTYTWO.

CLOSELY FOLLOW SHOOTING INCIDENT SET FORTH IN REFERENCED TELETYPE AND PROMPTLY FURNISH BUREAU ALL PERTINENT DEVELOPMENTS. FURNISH PERTINENT DETAILS TO THE SAN DIEGO POLICE DEPARTMENT; HOWEVER, WITHHOLD IDENTITY OF INFORMANT. THE IDENTITY OF INFORMANT SHOULD BE GIVEN ONLY AS A LAST RESORT AND THEN ONLY TO AN ESTABLISHED POLICE CONTACT WHO WILL HANDLE THE MATTER CONFIDENTIALLY.

REMINDE INFORMANT TO AVOID DIRECTLY BECOMING INVOLVED IN SITUATIONS THAT MIGHT DEVELOP INTO VIOLENT ACTIVITIES.

RLR:pjc pjc  
(9)

NOTE:

See memorandum G. C. Moore to Mr. E. S. Miller, dated 1/14/72, captioned "SD 1155-E, Extremist Informant," prepared by RLR:pjc.

- Mr. Tolson \_\_\_\_\_
- Mr. Felt \_\_\_\_\_
- Mr. Rosen \_\_\_\_\_
- Mr. Mohr \_\_\_\_\_
- Mr. Bishop \_\_\_\_\_
- Mr. Miller, E.S. \_\_\_\_\_
- Mr. Callahan \_\_\_\_\_
- Mr. Casper \_\_\_\_\_
- Mr. Conrad \_\_\_\_\_
- Mr. Dalbey \_\_\_\_\_
- Mr. Cleveland \_\_\_\_\_
- Mr. Ponder \_\_\_\_\_
- Mr. Bates \_\_\_\_\_
- Mr. Wainart \_\_\_\_\_
- Mr. Walters \_\_\_\_\_
- Mr. Soyars \_\_\_\_\_
- Tele. Room \_\_\_\_\_
- Miss Holmes \_\_\_\_\_
- Miss Gandy \_\_\_\_\_

GCM EM  
JAD  
R  
J

JAN 20 1972

Joe

FEDERAL BUREAU OF INVESTIGATION  
COMMUNICATIONS SECTION

JAN 13 1972

TELETYPE

Mr. Tolson	_____
Mr. Felt	_____
Mr. Rosen	_____
Mr. Mohr	_____
Mr. Bishop	_____
Mr. Miller, ES	_____
Mr. Callahan	_____
Mr. Casper	_____
Mr. Conrad	_____
Mr. Dalbey	_____
Mr. Cleveland	_____
Mr. Lender	_____
Mr. Bates	_____
Mr. Walters	_____
Mr. Walters	_____
Mr. Soyars	_____
Tele. Room	_____
Miss Holmes	_____
Miss Gandy	_____

NR 14 SD CODE  
 710 PM NITEL 01-13-72 DDC  
 TO DIRECTOR 134-17222  
 FROM SAN DIEGO 170-286 6P

G. R. [unclear]

CONF. INF. **INFORMATION**  
 SD ONE ONE FIVE FIVE DASH E. EM - MM.

1-14-72

RE SD TEL TO BU JANUARY SEVEN LAST, CAPTIONED CALREP; NEW  
 LEFT MOVEMENT - VIOLENCE, IS - NL

1-14-72 R.R. Pic

REFERENCED TELETYPE REPORTED AN INCIDENT WHEREIN A  
 YOUNG WOMAN, ALLEGEDLY A VISITOR AT FIVE ONE FIVE FIVE MUIR,  
 SAN DIEGO, THE RESIDENCE OF PETER GEORGE BOHMER (SD ONE  
 ZERO ZERO DASH ONE FIVE FOUR FIVE ZERO), WAS THE VICTIM OF  
 SNIPER FIRE RESULTING IN A GUNSHOT WOUND IN HER ELBOW. THE  
 RESIDENCE AT FIVE ONE FIVE FIVE MUIR IS A WELL-KNOWN NEW  
 LEFT COMMUNE NAMED "THE BOX" (SD ONE ZERO ZERO DASH ONE  
 FIVE NINE SEVEN ONE). IT HAS BEEN DETERMINED THE GUNSHOT  
 WOUND IS MINOR IN NATURE.

ON JANUARY TWELVE LAST CAPTIONED SOURCE WAS CONTACTED AT  
 WHICH TIME HE FURNISHED THE FOLLOWING INFORMATION:

EX-104 137-17222-14  
 REC-104  
 JAN 17 1972

END PAGE ONE

PAGE TWO

ON DECEMBER TWENTY SEVENTYONE, THE SECRET ARMY ORGANIZATION (SAO) (SD ONE FIVE SEVEN DASH TWO EIGHT ONE FIVE), A NEWLY FORMED RIGHT WING PARAMILITARY ORGANIZATION IN THE SAN DIEGO AREA, PREPARED AND DISTRIBUTED A NUMBER OF COPIES OF AN INTELLEGIENCE TYPE BULLETIN REGARDING PETER GEORGE BOHMER. INFORMATION UTILIZED IN THE BULLETIN WAS OBTAINED PRIMARILY FROM RESEARCH OF NEWSPAPER ARTICLES AND PHYSICAL SURVEILLANCE OF THE BOHMER RESIDENCE BY SAO MEMBERS, INCLUDING INFORMANT. RESPONSE TO THE BULLETIN FROM RIGHT WING SYMPATHIZERS WAS CONSIDERED ENCOURAGING BY THE SAO AND <sup>e</sup>CONSEQUENTLY ON JANUARY SIX LAST INFORMANT WAS REQUESTED BY JERRY LYNN DAVIS (SD ONE ZERO ZERO DASH ONE FOUR TWO NINE SEVEN), LEADER OF THE SAO, TO CONDUCT ANOTHER SURVEILLANCE OF THE BOHMER RESIDENCE FOR THE PURPOSE OF OBTAINING ADDITIONAL INTELLEGIENCE INFORMATION SUCH AS LICENSE PLATE NUMBERS AND DESCRIPTIONS AND

END PAGE TWO

PAGE THREE

HABITS OF OCCUPANTS. ANY INFORMATION OBTAINED WAS TO BE USED IN THE PREPARATION OF FORTHCOMING SAO INTELLIGENCE BULLETINS.

INFORMANT, NOT DESIRING TO CONDUCT SUCH A SURVEILLANCE ALONG, CONTACTED GEORGE M. HOOVER (SD ONE ZERO ZERO DASH ONE FIVE THREE FIVE SIX), AN ASSOCIATE OF SAO MEMBERS, REQUESTING HE ACCOMPANY SOURCE. SOURCE AND HOOVER ARRIVED IN THE VICINITY OF BOHMER'S RESIDENCE AT APPROXIMATELY EIGHT FORTYFIVE PM, JANUARY SIX LAST, WATCHED THE RESIDENCE FOR A PERIOD OF TIME, DETERMINED THERE WERE NO CARS PARKED ON THE STREET NEAR THE HOUSE, OBSERVED TWO INDIVIDUALS LEAVE THE HOUSE AND WALK AWAY TO AN UNKNOWN DESTINATION, AND FROM THE SUBSEQUENT APPEARANCE OF THE HOUSE ASSUMED IT THEN TO HAVE BEEN UNOCCUPIED. SOURCE AND HOOVER WENT SO FAR AS TO PLACE AN SAO STICKER ON THE FRONT DOOR OF THE RESIDENCE FOLLOWING WHICH THEY DROVE BY THE HOUSE ONE LAST TIME PRIOR

END PAGE THREE

PAGE FOUR

TO GOING HOME. AT THIS TIME, WITHOUT WARNING, HOOVER, WHO IS GENERALLY ARMED, POINTED A PISTOL OUT THE PASSENGER WINDOW OF THE CAR FIRING TWO SHOTS AT THE HOUSE. SOURCE YELLED AT HOOVER, "WHAT DO YOU THINK YOU'RE DOING?" AND THEN LEFT THE AREA AS QUICKLY AS POSSIBLE. SOURCE STATED THAT FORTUNATELY THE PISTOL, AN AUTOMATIC, JAMMED ON THE THIR<sup>d</sup> SHOT OR HE FEELS CERTAIN HOOVER WOULD HAVE EMPTIED THE CLIP IN THE GUN. SOURCE ADVISED HE UNDERSTANDS THAT THE WEAPON HAS BEEN DISPOSED OF.

IT IS NOTED SOURCE WAS DRIVING HIS SIXTYNINE RAMBLER AMERICAN, MEDIUM BLUE, GENERALLY MATCHING THE DESCRIPTION OF THE SHOOTING VEHICLE AS FURNISHED BY WITNESSES TO THE POLICE.

SOURCE EXPLAINED HE WAS RELUCTANT TO DISCUSS THIS MATTER IN DETAIL WHEN TELEPHONICALLY CONTACTED REGARDING THE SHOOTING ON JANUARY SEVEN LAST AS HIS WIFE WAS PRESENT AT THAT TIME AND HE DID NOT DESIRE TO UPSET HER UNNECESSARILY.

END PAGE FOUR

PAGE FIVE

HE STATED THAT THE ABOVE SHOOTING HAD COME AS A COMPLETE SURPRISE TO HIM AND THAT HE HAD NO INTENTION OR DESIRE TO TAKE ANY ACTION AT BOHMER'S RESIDENCE OTHER THAN TO OBTAIN WHATEVER INFORMATION WAS AVAILABLE AS DISCREETLY AS POSSIBLE. HE STATED HE IS EXTREMELY UPSET AND DISMAYED AT THIS TURN OF EVENTS.

IN CONNECTION WITH HIS ACTIVITIES IN BEHALF OF THE BUREAU, INFORMANT HAS BEEN REPEATEDLY CAUTIONED TO AVOID BECOMING DIRECTLY INVOLVED IN ANY SITUATION WHICH MIGHT CAUSE DEATH OR PERSONAL INJURY TO ANY PERSON. SOURCE HAS WHOLEHEARTEDLY AGREED WITH THIS POSITION AND HAS CONSISTANTLY FURNISHED ALL INFORMATION IN HIS POSSESSSION REGARDING THE POSSIBLE OCCURRENCE OF SUCH INSTANCES. IT IS BELIEVED SOURCE WAS TOTALLY UNAWARE THAT HOOVER MIGHT SHOOT INTO THE HOUSE PRIOR TO THE OCCURENCE OF THE INCIDENT AND HE HAS BEEN CAUTIONED TO AVOID ALL UNNECESSARY CONTACT WITH HOOVER IN THE FUTURE.

END PAGE FIVE

PAGE SIX

SOURCE STATED, TO HIS KNOWLEDGE, ONLY HE AND HOOVER ARE PRESENTLY AWARE OF THIS INCIDENT. SOURCE ADVISED THE INCIDENT APPEARS TO HAVE CAUSED HOOVER TO BECOME "FIRED UP" AND READY FOR A VIOLENT CONFRONTATION WITH THE POLICE IF APPROACHED ON THE MATTER. HE SAID HE DOUBTS HOOVER WOULD DISCUSS THE INCIDENT WITH ANYONE ELSE BUT CANNOT BE SURE OF THIS. IN VIEW OF HOOVER'S UNPREDICTABLE NATURE AND PRESENT EMOTIONAL STATE, SOURCE SAID HE WOULD ADVISE AGAINST ANY INTERVIEW OF HOOVER.

UACB, THE FOREGOING INFORMATION WILL BE DISCUSSED DISCREETLY WITH THE SAN DIEGO POLICE DEPARTMENT AND, IF NECESSARY, INFORMAT'S IDENTITY WILL BE FURNISHED TO THAT DEPARTMENT AT A LATER DATE.

END

UNITED STATES GOVERNMENT

# Memorandum

Tolson	_____
Felt	_____
Rosen	_____
Moore	_____
Bishop	_____
Miller	_____
Callahan	_____
Casper	_____
Conrad	_____
Dalbey	_____
Cleveland	_____
Ponder	_____
Bates	_____
Waikart	_____
Walters	_____
Soyars	_____
Tele. Room	_____
Holmes	_____
Gandy	_____

- 1 - Mr. A. Rosen
- 1 - Mr. E. S. Miller
- DATE: 1/14/72
- 1 - Mr. R. L. Shackelford
- 1 - Mr. G. C. Moore
- 1 - Mr. L. G. Brockman
- 1 - Mr. J. G. Deegan
- 1 - Mr. R. L. Ridgeway

TO : Mr. E. S. Miller

FROM : G. C. Moore

SUBJECT: CONF. INET  
SD 1155-E Informant  
 EXTREMIST INFORMANT

This is to advise of information developed by captioned informant disclosing a shooting incident arising from activities of the newly organized white extremist Secret Army Organization.

By memorandum dated 1/11/72, you were advised of the formation and activities of the newly formed ultraconservative white extremist paramilitary group known as Secret Army Organization (SAO). SAO has targeted for harassment San Diego State College Professor Peter Bohmer. Bohmer's residence is a well-known New Left commune, whose occupants, along with Bohmer, are planning demonstrations at the Republican National Convention scheduled at San Diego for August, 1972.

Captioned informant, a 28-year-old white male operated since August, 1967, has been recently targeted to penetrate the extremist-oriented SAO. On January 6, 1972, informant was requested by SAO leader to surveil Bohmer's residence in order to obtain intelligence information. Accompanying informant on surveillance was SAO associate George M. Hoover. The surveillance, held during the evening of January 6, 1972, was discontinued after the Bohmer residence appeared unoccupied. However, prior to discontinuance, an SAO sticker was left at the front door. While passing in front of the house in informant's automobile, Hoover, without warning and to the complete dismay of informant, fired two shots into the house. The informant strongly protested and they sped away. A female occupant of the house reportedly sustained minor gunshot wound in her elbow.

Enclosure

137-17222

RLR:pjc  
(8)

JAN 27 1972

137-17222-14X  
 5-17222-14X

REC-2  
 CONTINUED OVER

JAN 20 1972



Memorandum to Mr. E. S. Miller  
Re: SD 1155-E  
134-17222

Informant furnished details of the shooting, which would not have been available through any other source, and cautioned that Hoover is "fired up" over the incident and ready for a violent confrontation should police approach him on this matter. Identities of those involved in shooting not known to San Diego police; however, witnesses did furnish description of informant's automobile.

This informant, during his utilization, has furnished exceptionally valuable information on the Minutemen and has been completely reliable. He has been previously cautioned, as all extremist informants are, not to become directly involved in violent confrontations or activities. He is the only Bureau source covering the violence-prone SAO. San Diego has advised that pertinent information developed by informant will be furnished to the San Diego Police Department but informant's identity withheld unless disclosure becomes necessary. There appears to be no objection to this, and San Diego will be instructed to closely follow this matter and promptly report pertinent developments.

RECOMMENDATION:

That attached teletype in accordance with above be approved and sent.

*Detached  
& sent 11/14  
WBS*

[NIFEL]

*PER JGD  
DEM*

*OK R  
PLEP  
7*

*EM  
WBS  
AS*

CODE

TELETYPE

URGENT

6/26/72

TO: SAC, SAN DIEGO (170-286)

1 - Mr. T. F. Howard

1 - Mr. W. C. Patterson

FROM: ACTING DIRECTOR, FBI (134-17222)

1 - Mr. R. L. Ridgeway

~~SD ONE ONE FIVE FIVE DASH E~~ Informant

REURTELETYPE JUNE TWENTY-TWO LAST CAPTIONED "UNSUB; BOMBING OF GUILD MOVIE THEATER, THREE EIGHT TWO SEVEN DASH FIFTH AVENUE, SAN DIEGO, CALIFORNIA, JUNE NINETEEN LAST. EID."

AUTHORITY GRANTED TO MAKE CAPTIONED INFORMANT AVAILABLE TO SAN DIEGO POLICE DEPARTMENT (SDPD) FOR PURPOSE STATED IN REFERENCED TELETYPE ONLY IF INFORMANT IS A WILLING WITNESS AND ONLY AS A LAST RESORT TO INSURE PROSECUTIVE ACTION. SDPD MUST CLEARLY UNDERSTAND THAT INFORMANT HOLDS GREAT FEAR FOR HIS LIFE AND PERSONAL SAFETY SHOULD HE BE SURFACED AND IT IS THEIR RESPONSIBILITY TO PROVIDE ANY NECESSARY PROTECTION TO INFORMANT SHOULD HE BE USED. SDPD SHOULD BE ENCOURAGED TO EXPLORE ALL OTHER AVENUES TO SECURE PROSECUTION AGAINST SUSPECT WAKOPEC BEFORE UTILIZING INFORMANT AS A WITNESS.

MC

REC-33 137-17222-15

- alt \_\_\_\_\_
- thr \_\_\_\_\_
- sen \_\_\_\_\_
- les \_\_\_\_\_
- hop \_\_\_\_\_
- 'ahan \_\_\_\_\_
- pbell \_\_\_\_\_
- er \_\_\_\_\_
- eland \_\_\_\_\_
- id \_\_\_\_\_
- y \_\_\_\_\_
- all \_\_\_\_\_
- E.S. \_\_\_\_\_
- \_\_\_\_\_
- \_\_\_\_\_
- oom \_\_\_\_\_
- ey \_\_\_\_\_
- trong \_\_\_\_\_
- ig \_\_\_\_\_
- ian \_\_\_\_\_

RLR:klk (5)

JUN 23 5 55 PM '72

25 JUN 28 1972

FBI - POLICE RECEIVED WITNES

Handwritten initials/signature

FEDERAL BUREAU OF INVESTIGATION COMMUNICATIONS SECTION

SEE NOTE ON PAGE TWO

JUN 26 1972 GXC TELETYPE JUL 3 1972

Handwritten notes: GCM, JUN 27 1972, R-12

MAIL ROOM  TELETYPE UNIT

UNRECORDED COPY FILED IN 174-2

TELETYPE TO SAN DIEGO

RE: SD 1155-E

134-17222

NOTE:

William Yakopec, El Cajon, California, has disclosed to captioned informant that he is responsible for bombing of Guild Movie Theater in San Diego and plans additional bombings. Informant is acquainted with Yakopec through involvement in Secret Army Organization (SAO), an extremist right-wing group in San Diego. Without informant's testimony, SDPD will not be able to obtain arrest warrant for Yakopec. Therefore, SDPD requests informant be made available as prosecution witness. Informant believed extremely reluctant to testify for fear of life and personal safety. SAC recommends informant be made available to SDPD provided he is willing to cooperate and PD can afford protection. Informant is member of SAO on behalf of Bureau. He is a 28-year-old white male operated since 1967.

1 - Mr. R. L. Ridgeway  
1 - Mr. F. A. Tansey

SAC, San Diego (170-286)

7/3/72

EX-112

Acting Director, FBI (137-27222)

Attention: Voucher-Statistical Section

SD 1155-E

Reurlet 6/20/72.

Authority is granted to designate captioned individual a Bureau-approved PSI and to proceed to develop source as a security informant in accordance with instructions set forth in Section 107, Volume IV, Manual of Instructions.

Authority is granted to designate captioned individual as a  probationary extremist informant  ghetto extremist informant in accordance with instructions set out in Section 130, Volume IV, Manual of Instructions.

Authority is granted to pay captioned informant an amount up to \$ 250 per  month  week for services rendered on a c.o.d. basis, and up to \$ 100 per  month  week for expenses actually incurred for a period of six  months  weeks effective 6/1/72. You should continue to maintain contact with informant and follow appropriate instructions in the Manual of Instructions.

Advise captioned informant that the Bureau is not concerned with the legitimate activities of the college or university or of its students. Do not contact informant on the campus.

Bufiles disclose no pertinent information regarding  captioned source  immediate relatives of source

Concerning your payments to this informant and all informants, you are reminded that payments must be commensurate with the value of the information received; that payments are to be made only for actual expenses incurred in connection with obtaining information for the FBI. In addition, payments should be made in such a manner that the informant clearly understands he is not being paid on a salary basis but rather on a c.o.d. basis.

Make certain informant understands cooperation with Bureau is strictly voluntary and that this cooperation must be maintained on a confidential basis at all times. Impress upon informant that informant is not Bureau employee. Exercise caution in your contacts with informant to make certain informant is not a plant.

FAT:klk (5)

- Felt \_\_\_\_\_
- Campbell \_\_\_\_\_
- Rosen \_\_\_\_\_
- Vohr \_\_\_\_\_
- Bishop \_\_\_\_\_
- Miller, E.S. \_\_\_\_\_
- Callahan \_\_\_\_\_
- Casper \_\_\_\_\_
- Conrad \_\_\_\_\_
- Dalbey \_\_\_\_\_
- Cleveland \_\_\_\_\_
- Ponder \_\_\_\_\_
- Bates \_\_\_\_\_
- Waikart \_\_\_\_\_
- Walters \_\_\_\_\_
- Soyars \_\_\_\_\_
- Tele. Room \_\_\_\_\_
- Holmes \_\_\_\_\_
- Gandy \_\_\_\_\_

MAIL ROOM TELETYPE UNIT

RECEIVED  
JUL 10 1972  
FBI

MBM

DEM/ADD

GCM

EM/DEM

SEE NOTE ON PAGE TWO

FAN

FAT

Letter to San Diego  
Re: SD 1155-E  
137-17222

In the future you should be certain that request for payment authorization is submitted at least two weeks in advance of the effective date.

NOTE:

This is a continuation of previously authorized payment levels. Informant is a member of the Secret Army Organization (SAO) in San Diego, California, and is the principal informant reporting on this and other right-wing groups in the San Diego area. He has also furnished considerable valuable information concerning revolutionary activities groups and anti-law enforcement demonstrations. Specifically, he has furnished 83 reports concerning several functions and 30 to 40 individuals. Ninety-five per cent of the information furnished by him has been verified through other sources. He has reported data concerning contacts between the SAO and the Minutemen including the branch headed by Jesse Stevens in Maryland with regard to possible alliance being formed between these two groups. He has been in contact with the leader of the National Socialist White Peoples Party (NSWPP); has reported on the acquisition of weapons and explosives by the San Diego members of SAO; and has provided substantial information regarding finances and sources of funds of SAO. He furnished data concerning sale and delivery of weapons and other military surplus items by an individual from the Seattle, Washington, area. Based on quality and quantity of information, payments are fully justified.

UNITED STATES GOVERNMENT

# Memorandum

TO *Handwritten initials* ACTING DIRECTOR, FBI (137-17222) DATE: 6/20/72

FROM SAC, SAN DIEGO (170-286)(P)

SUBJECT: CONF. INFL.  
SD 1155-E / *v for a cert 7-13*  
EM-SAO

*Held*

Re: EXTREMIST OR SECURITY INFORMANT PROGRESS/JUSTIFICATION LETTER

I.  (a) I recommend that authority be granted to continue captioned informant for a period of \_\_\_\_\_ months effective \_\_\_\_\_ and that he continue to be paid under the authority of the Special Agent in Charge, UACB.

(b) I recommend that authority be granted to pay captioned informant an amount up to \$ \$250.00 per  month  week for services rendered on a c.o.d. basis, and up to \$ 100.00 per  month  week for expenses actually incurred for a period of Six (6)  months  weeks effective 6/1/72.  
(If increase, furnish full justification under "Miscellaneous.")

II. Membership: Informant is a member of the Secret Army Organization (SAO) in the San Diego, California, area.

Amount paid for services and expenses:

(SEE PAGE 1-A)

Number of activities and persons on whom coverage is provided:

Informant reports regularly on activities of 30 to 40 individuals associated with the SAO organization and related right wing groups in the San Diego, California area. He continues to be employed by the San Diego City Fire Department which employment affords him considerable free time which he can use to observe and report on activities of many radical and militant individuals and organizations on and off college campuses in the San Diego area.

Number of statements (written and oral) submitted: EX-112 83 117-17222-16

Considered stable and reliable  Yes  No (Explain in "Miscellaneous.")

Indoctrinated against disclosure  Yes

Percentage of information verified 95%

All necessary action taken on information furnished  Yes  No (Explain in "Miscellaneous.")

③ - Bureau (RM)  
I - San Diego

EX-112

38

Q

16

EXT. *Handwritten signature*

*Handwritten notes:*  
FAT-KLK  
6/30/72  
6/21/72  
#222.44

SD 170-286

Amount paid for services and expenses:

<u>PERIOD</u>	<u>SERVICES</u>	<u>EXPENSES</u>
12/1 - 31/71	\$215.00	\$38.75
1/1 - 31/72	220.00	22.40
2/1 - 29/72	205.00	50.00
3/1 - 31/72	205.00	31.40
4/1 - 30/72	220.00	52.70
5/1 - 31/72	215.00	27.19

1-A

Summary of information furnished: *(If more space needed, add addendum.)*

157-7557-11  
On January 28, 1972, source advised that the SAO had been contacted by Newsweek magazine and also by a San Diego daily newspaper, The Evening Tribune, asking for interviews for articles they wished to run on the organization.

During the early part of 1971 source made available a list of several hundred names which were represented to him as being a mailing list compiled by TROY HAUGHTON, former West Coast leader of the Minutemen Organization. Furthermore, source made available copies of all printed matter distributed by the SAO and furnished information relating to contact between the SAO and a Minutemen type group being operated by an individual named JESSE CLAYBURN STEVENS at Silver Springs, Maryland, and the possible formation of an alliance of these two groups.

(SEE ADDENDUM)

Miscellaneous: *(Furnish steps being taken to advance informant, and any other pertinent information which should be brought to Bureau's attention.)*

Informant has been instructed to report on compensation received from the Bureau for services as income when filing his income tax return and he has agreed to comply.

Informant has been encouraged to take advantage of any opportunities to improve his coverage of activities of interest to the Bureau in the San Diego area. Through his close association with individuals involved in extremist activities in the San Diego area, he has been able to achieve a leadership position in these activities, particularly in the newly formed Secret Army Organization.

Delay in submission of this letter was caused by the urgency of other important investigative matters having to do with protection of presidential candidates and preparation for the 1972 Democratic and National Conventions.



SD 170-286

In January, 1972, source contacted GERALD LEE SMITH, leader of the National Socialist White People's Party (NSWPP), at San Diego, and provided information relating to his philosophies, plans and activities. Through contact with associates who are familiar with NSWPP activities, source generally has been able to stay abreast of important happenings of that organization, and has attended some public meetings of the group.

During the period in question source has provided a large quantity of information relating to the acquisition and use of weapons by members of the SAO and related individuals. In January source advised that JERRY LYNN DAVIS, San Diego area leader of the SAO, claimed to have obtained the keys to the powder magazine of a large sand and gravel company in the area, and that in the future he planned to enter the magazine, take away as much of the explosives as possible and then blow up the rest to destroy any evidence of the theft.

In February, 1972, source advised of efforts by DAVIS to obtain two 81 mm mortars from two unidentified individuals at Los Angeles, California. He further reported on the acquisition of a complete military radio by the SAO known to him, which he has continued to do throughout the reporting period. In this regard he has identified several new members of the group as well as associates of these members, and also potential members of the organization. Source has furnished information pertaining to the relocation of several of these individuals to other parts of the country, particularly BETTIE HAUGHTON, wife of TROY HAUGHTON, who moved to a remote part of California in March and subsequently remarried.

In March the source provided information about the finances of the SAO and the sources of its funds. He also advised of the travel to San Diego by CY ANDERSON of Seattle, Washington, who brought with him a large quantity of weapons, military surplus items and other articles to sell.

SD 170-386

In May, 1972, source identified CLAVIN HENDELL FOX as a new member of the SAO and furnished information regarding travel to Washington, D.C., by FOX to participate in a victory march sponsored there by Reverend CARL MC INTYRE.

UNITED STATES GOVERNMENT

# Memorandum

TO : ACTING DIRECTOR, FBI (137-17222) DATE: 11/20/72

FROM : SAC, SAN DIEGO (170-286) (P)

SUBJECT: HOWARD BARRY GODFREY  
(Formerly SD 1155-E) *in front*  
EI - SAO, MINUTEMEN  
(OO: San Diego)

Re San Diego letter to Bureau dated 6/20/72 and Bureau letter to San Diego dated 7/3/72.

Source was contacted on November 14, 1972, and was advised that since he had left the area and would not be able to furnish information to the Federal Bureau of Investigation concerning activities in San Diego, his agreement to furnish information to the Bureau was terminated as of that date and he would no longer be operated by the Bureau.

Source stated that he is willing to testify in Federal, State or Local court or before a congressional hearing if subpoenaed for such testimony. He was reminded that he should continue to be factual and truthful in any such testimony and that he should not embellish his statements in any way. He has been advised that he will testify in a Federal trial of subject; THOMAS LEE FORREST, where the Bureau of Alcohol, Tobacco and Firearms, San Diego, is prosecuting FORREST for the sale of automatic weapons conversion kits.

Source is presently testifying in San Diego County Superior Court in a case involving GEORGE MITCHELL HOOVER, Secret Army Organization (SAO) member, who is charged with attempted murder. He will testify in cases involving

- 2- Bureau
- 2- Los Angeles
- 2- San Diego

EMP/ed  
(6)

REC-72

137-17222-17

ST 101

NOV 24 1972

INT. SEC.

DEC 5 1972

100 810 940

SD 170-286

JERRY LYNN DAVIS, SAO leader, for possession of explosives; DINO MARTINELLI, and CALVIN HENDALL FOX for perjury in the trial of WILLIAM FRANCIS YAKOPEC, who was found guilty of the bombing of the Guild Theatre in San Diego. YAKOPEC was sentenced to one year to life and a concurrent sentence of one to five years on another charge. He will keep the Federal Bureau of Investigation advised of any further testimony required of him.

Source was advised that because of publicity resulting from his exposure as an FBI paid informant during the trials now in progress, he might be contacted by the press, radio or television for public appearances. He advised that he will always feel free to contact the Bureau for assistance and guidance if he is contacted to make any kind of public appearance.

He advised that he has been contacted by an individual named LAURITZ P. MILLER, 8337 Castano Place, Sun Valley, California, who advised him that he is a writer and would like to cooperate with him in the writing of a book regarding "right wing" activities, including that of the Secret Army Organization. MILLER claims to have some information already in his possession regarding "right wing" organizations.

Source stated that he is giving serious consideration to writing a book and that he will appreciate any advice and guidance the Bureau can give him. The book would place the FBI in a favorable light. He requested that he be advised if the Bureau has any information concerning MILLER which would make it undesirable to work with him on the book.

Source was advised that the Bureau will not sponsor or endorse any book or publication he might write.

Flash notice on source <sup>will</sup> has been removed in ONE YEAR. )

SD 170-286

No FD 401 being submitted. Source has been paid the following amounts for services and expenses since June 1, 1972:

<u>Date</u>	<u>Services</u>	<u>Expenses</u>
7/10/72	\$250.00	\$100.00
7/10/72	-	\$200.00
8/3/72	\$250.00	\$100.00
9/6/72	\$150.00	-
11/14/72	\$100.00	-

LOS ANGELES

Search Indices regarding LAURITZ P. MILLER, 8337 Castano Place, Sun Valley, California, and advise Bureau and San Diego of any pertinent information.

UNITED STATES GOVERNMENT

# Memorandum

TO : ACTING DIRECTOR, FBI (137-17222)

DATE: 12/22/72

FROM : ASSISTANT DIRECTOR, LOS ANGELES  
(157-8214) (RUC)

SUBJECT: HOWARD BARRY GODFREY  
(formerly SD 1155-E) *interview*  
EM - SAO, MINUTEMEN  
OO: San Diego

Re San Diego letter to the Bureau, dated 11/20/72.

On 8/11/72, Mr. LAURITZ P. MILLER, 8337 Castano Place, Sun Valley, California, wrote a letter to the Acting Director, FBI, in which he advised as follows:

MILLER, a free-lance writer, had recently returned to Los Angeles from Japan, where he had researched a potential story on the Japanese terrorist groups that provided three gunmen for the Lod Airport massacre in Tel Aviv, Israel, 5/30/72. According to information learned by MILLER there was a strong indication of a world-wide Communist conspiracy dedicated to international revolution. Mr. MILLER related some of the facts which he learned concerning the Red Army group in Japan and its ties to revolutionary groups throughout the world.

On 8/23/72, Mr. MILLER was interviewed concerning details of the information which he had related in his letter to the Bureau. After the interview MILLER produced several books written in Japanese which he had had partially translated and which were extremely revolutionary and violent in nature. These books were forwarded to the Bureau for complete translation.

Mr. MILLER seemed to be a reasonable man who was very concerned about the dangers posed by terrorists organizations throughout the world.

- 2 - Bureau (RM)
- 2 - San Diego (170-286) (RM)
- 1 - Los Angeles

REC-49

137-17222-18

ST-115

4 JAN 2 1973

JCD/clc  
(5)

JAN 9 1973

Buy U.S. Savings Bonds Regularly on the Payroll Savings Plan

FBI

Date: 3/1/73

Transmit the following in \_\_\_\_\_  
(Type in plaintext or code)

Via AIRTEL \_\_\_\_\_  
(Priority)

TO: ACTING DIRECTOR, FBI (137-17222) ATTN: OFFICE OF LEGAL COUNSEL  
FROM: SAC, SAN DIEGO (170-286) (P)

HOWARD BARRY GODFREY  
FORMER SD 1155-E *informant*  
EM - SAC  
(OO: San Diego)

Re San Diego letter to Bureau dated 11/20/72; Los Angeles letter to Bureau dated 12/22/72.

On 2/23/73, LAURITZ P. MILLER, Sun Valley, California, telephone (213) 767-3581, telephonically contacted SA EARL M. PETERSEN stating that he was planning to assist former FBI informant HOWARD BARRY GODFREY in writing a book concerning his experiences while assisting the FBI. He advised that the book will be pro-FBI and will be as factual as possible. He stated that he would like to verify that GODFREY had actually reported to the FBI some of the things that he has reported to him in discussing the preparation of the book.

HOWARD BARRY GODFREY was formerly SD 1155-E *informant*

MILLER was advised that he could be furnished no information without the specific authority of the Acting Director of the FBI and, possibly, the additional approval of the U. S. Department of Justice.

MILLER stated that it is his intention to prepare a letter to the Acting Director of the FBI setting forth information concerning the book he intends to write and requesting authority to obtain information that he needs to verify the authenticity of information furnished by GODFREY.

- 2 - Bureau (RM)
- 1 - Los Angeles (157-8214) (INFO) (RM)
- 2 - San Diego

EMP:clb  
(5)

DECLASSIFIED

25 MAR 3 1973

Approved: \_\_\_\_\_

Sent \_\_\_\_\_ M Per \_\_\_\_\_

February 28, 1973

Patrick L. Gray, Director  
Federal Bureau of Investigation  
Washington, D.C. 20535

Mr. Hoover   
Mr. Helm \_\_\_\_\_  
Mr. Harboison \_\_\_\_\_

Mr. Felt \_\_\_\_\_  
Mr. Baker \_\_\_\_\_  
Mr. Callahan \_\_\_\_\_  
Mr. Cleveland \_\_\_\_\_  
Mr. Conrad \_\_\_\_\_  
Mr. Gearty \_\_\_\_\_  
Mr. Jenkins \_\_\_\_\_  
Mr. Marshall \_\_\_\_\_  
Mr. Miller, E.S. \_\_\_\_\_  
Mr. Parris \_\_\_\_\_  
Mr. Soyars \_\_\_\_\_  
Mr. Walters \_\_\_\_\_  
Tele. Room \_\_\_\_\_  
Mr. Kinley \_\_\_\_\_  
Mr. Armstrong \_\_\_\_\_  
Mr. Bowers \_\_\_\_\_  
Mr. Herington \_\_\_\_\_  
Ms. Herwig \_\_\_\_\_  
Mr. Mintz \_\_\_\_\_  
Mrs. Neenan \_\_\_\_\_

Dear Sir:

As you have been informed by Agent Earl Peterson of San Diego I am collaborating with Howard Barry Godfrey to produce a book based on his experiences as an informant for the Bureau.

I would like to assure you we intend to present the Federal Bureau of Investigation in only a favorable way.

Our motive for writing this book is to alert the general public of a dangerous situation developing (and in some cases well established) in every major community in the nation.

Godfrey wants to lay out the nation network of communication between extremist groups, both right and left wing.

He plans to recount as much detail as possible of his years as a member of these extremist groups, explaining the recruiting, training, assignment and some actual operations accomplished by them.

It would be of great assistance to us if you would authorize me to interview Agent Peterson in San Diego. This would not constitute an endorsement of our Book, but would help me to understand more about Godfrey, the general situation, and the position of the F.B.I. in coping with paramilitary organizations.

I will naturally agree to any conditions you suggest for holding such an interview.

32 MAR 2 1973  
900-3-11-29  
FILED IN 900-3-11-29

137-17222-  
NOT RECORDED  
MAR 20 1973

see Brownfield  
Stankins memo  
3-8-73  
A.E.S. dky

Act let  
3-9-73  
H.E.S. dky

MAR 19 1973

CONFIDENTIAL



Hoping to hear from you soon, I remain

Very truly yours,

LPM: jm

UNITED STATES GOVERNMENT

# Memorandum

TO : Mr. Jenkins *TJG*

DATE: 3-8-73

FROM : T. J. Brownfield *TJB*

SUBJECT: LAURITZ P. MILLER  
FREE LANCE WRITER,  
SUN VALLEY, CALIFORNIA  
REQUEST TO INTERVIEW SA EARL M.  
PETERSEN, SAN DIEGO OFFICE

- Mr. Felt \_\_\_\_\_
- Mr. Baker \_\_\_\_\_
- Mr. Callahan \_\_\_\_\_
- Mr. Cleveland \_\_\_\_\_
- Mr. Conrad \_\_\_\_\_
- Mr. Gebhardt \_\_\_\_\_
- Mr. Jenkins
- Mr. Marshall
- Mr. Miller
- Mr. Soyars \_\_\_\_\_
- Mr. Thompson \_\_\_\_\_
- Mr. Walters \_\_\_\_\_
- Tele. Room \_\_\_\_\_
- Mr. Kinley \_\_\_\_\_
- Mr. Armstrong \_\_\_\_\_
- Mr. Bowers \_\_\_\_\_
- Mr. Herington \_\_\_\_\_
- Ms. Hervig \_\_\_\_\_
- Mr. Mintz \_\_\_\_\_
- Mrs. Neenan \_\_\_\_\_

*Sluff*  
*5 Miller*  
*MEMO*

*John*

BACKGROUND:

By letter dated February 28, 1973, Miller advised he is collaborating with Howard Barry Godfrey to produce a book based on Godfrey's experiences as an FBI informant. Although the letter was unsigned, it bore letterhead information including Miller's name and address, 8337 Castano Place, Sun Valley, California. Miller's stationery described him as a "Freelance Writer-Photographer-Editor." Miller said he and Godfrey intended to present the FBI "in only a favorable way," and that Godfrey would describe "the nation network of communication by the extremists groups, both right and left wing," recounting his years as a member of these extremists groups.

Miller requested authorization for interview of "Agent Earl Peterson of San Diego" (SA Earl M. Petersen), explaining the interview "would help me to understand more about Godfrey, the general situation, and the position of the F.B.I. in coping with paramilitary organizations."

By airtel dated March 1, 1973, the San Diego Office advised that Miller had telephonically contacted Special Agent Petersen regarding interviewing him and that Miller was advised he could be furnished no information without the specific authority of the Acting Director of the FBI and, possibly, the additional approval of the Department of Justice.

INFORMATION IN BUFILES:

Regarding Godfrey:

Howard Barry Godfrey, born July 1, 1943, at Portsmouth, England, was designated a symbol-number informant

Enclosure *sent 3-9-73 mlb*

- 5 *MAR 28 1973* Mr. Jenkins - Enclosure
- 1 Mr. Miller - Enclosure
- 1 - Mr. Mintz - Enclosure

NOT RECORDED  
178 MAR 23 1973

"CONTINUED" OVER

ORIGINAL FILED IN 69-115975-12

Brownfield to Jenkins Memo  
RE: LAURITZ P. MILLER

of the San Diego Office August 10, 1967, while employed as an equipment-checker for Pacific Telephone and Telegraph Company, San Diego, California. A gun hobbyist, Army trained in the use of explosives, he became associated with the top echelon of the Minutemen as well as the Secret Army Organization (SAO), furnishing excellent information to the FBI regarding these and other extremists groups.

By communication dated November 20, 1972, the San Diego Office discontinued Godfrey as an informant. Godfrey had testified in San Diego County Superior Court in the trial of George Mitchell Hoover, SAO member charged with attempted murder, and in the trial of William Francis Yakopec, who was found guilty of the bombing of the Guild Theater in San Diego. At that time, Godfrey also was scheduled to testify against Jerry Lynn Davis, SAO leader charged with illegal possession of explosives.

SA Petersen also testified in Hoover's trial and had been Godfrey's contacting Agent.

As a result of Godfrey's appearances as a prosecution witness, his identity as an FBI informant was publicized in the news media. (137-17222, 157-17513-10)

Regarding Miller:

Our files show that by letter dated November 30, 1971, Miller requested information regarding crimes committed by juvenile females. He was furnished a Uniform Crime Reports Bulletin.

Miller wrote to Acting Director Gray August 11, 1972, furnishing information regarding what he considered to be a world-wide communist conspiracy for revolution, including direct communication between U. S. revolutionaries and the Japanese. Miller stated that some American servicemen were sympathetic with the world revolutionaries and were being used as couriers. Miller explained he had developed this information while doing research in Japan. He requested information as to whether the FBI knew of the "situation."

By airtel August 21, 1972, the Los Angeles Office was advised of Miller's August 11th letter and was instructed to interview him. The Los Angeles Office further was instructed to advise Miller of the confidential nature of information contained in Bureau files and to alert him regarding the jurisdictions of the respective military services over their personnel.

Brownfield to Jenkins Memo  
RE: LAURITZ P. MILLER

Miller was subsequently advised by the Los Angeles Office per instructions and the information he furnished was forwarded to the Legal Attache, Tokyo.

Miller also furnished similar information directly to the Japanese National Police Agency (NPA), in August, 1972. The NPA in October, 1972, advised the Legal Attache, Tokyo, that NPA's inquiry failed to substantiate Miller's allegations. (62-115275)

ADDITIONAL INFORMATION:

On March 6, 1973, ASAC Clark F. Brown, San Diego Office, was telephonically advised of Miller's request to interview SA Petersen in connection with the projected book. ASAC Brown was advised that interview of SA Petersen would not be authorized in view of regulations regarding revealing information in Bureau files.

This matter has been coordinated with the Intelligence Division and James L. Williamson of the Office of Legal Counsel.

RECOMMENDATION:

That the attached reply be sent to Miller.

HWS

JAM

UNITED STATES GOVERNMENT

# Memorandum

TO : ACTING DIRECTOR, FBI (137-17222)  
ATTN: FBI LABORATORY, FIREARMS SECTION

DATE: 4/30/73

FROM : SAC, SAN DIEGO (170-286)(C)

SUBJECT: HOWARD BARRY GODFREY  
FORMERLY SD 1155-E informant  
EM - SAO CONF. INFT.

*W. Williams*  
*4*  
*3*

Source made available a number of items during his activity as a source within the Secret Army Organization (SAO). He has authorized disposal of these items in any way seen fit by the San Diego Office of the FBI. The remaining items not used as evidence and not destroyed are:

One Browning Machine Gun, Caliber 50M2, U. S. Number 32846, manufactured by Colts Patent Firearms Manufacturing, Col., Hartford, Connecticut. This weapon is completely disassembled and the barrel has been cut off with a welding torch. This weapon was removed from a wrecked airplane on the desert and it was necessary to cut off the barrel to get the weapon out of the plane.

One .38 Caliber Silencer, no brand name, with Patent Pending and the number 96 stamped on it. Blue steel.

One sawed off shotgun barrel and stock (also sawed off) from Sears Roebuck model 1001.100 shotgun, no serial number. Barrel 13 1/2 inches long.

Two rifle grenade launchers. No identifying marks.

ST-104 REC-23 137-17222-20

The above-listed items are forwarded to the Firearms Section for disposal or for any other use desired of them.

*Weapons Destroyed in Laboratory*

- ③ - Bureau
- 1 - Package
- 1 - San Diego

EMP:mlr  
(5)

MAY 3 1973

*McCallister*

- 1 - General Investigative Division
- 1 - Internal Affairs Division
- 1 - Mr. D. W. Cowers
- 1 - Mr. H. A. Newman
- 1 - Mr. P. E. Nugent
- 1 - Mr. F. A. Tansey
- 1 - Mr. T. FitzPatrick

Mr. W. R. Wannall

2/7/74 1 - Mr. W. R. Wannall  
1 - Mr. G. C. Moore

G. C. Moore

THREE ANTI-FBI ARTICLES  
 APPEARING IN FEBRUARY, 1974, ISSUE OF  
 NATIONAL STATES RIGHTS PARTY (NSRP)  
 NEWSPAPER "THE THUNDERBOLT"  
 EXTREMIST MATTER - NSRP

Page 8 of the February, 1974, issue of "The Thunderbolt" (TT), a monthly newspaper of the NSRP, contains three articles critical of the FBI and, in part, of former Director J. Edgar Hoover. The NSRP is an antiblack, anti-Semitic, white racist political party headquartered in Marietta, Georgia, which is composed of past members of klan-type organizations. TT is edited by Dr. Edward R. Fields who is NSRP National Secretary.

The lead article is captioned "FBI Turned Into Secret Police." It discusses a lengthy written report allegedly given by former FBI Assistant to the Director William C. Sullivan to the White House, in which Sullivan "revealed" former Director Hoover "was not of sound mind in his last years"; how Director Hoover allegedly "kept files on Congressmen and blackmailed them"; and how the FBI allegedly committed illegal acts in "prosecuting white patriots" for many years. The article alleges that former White House aide John Dean III gave a copy of Sullivan's report to the Senate Watergate Committee (SWC); however, the SWC has allegedly suppressed it. Readers are urged to write their Congressmen and the SWC demanding release of the "Sullivan Report."

The article further alleges the FBI has been "wrecking patriotic organizations" while only "giving lip service to the fight against communism," and has experienced a "loss of reputation."

Enclosures (3)

- 105-66233
- 1 - 137-17222 (Cloward Godfrey)
- 1 - 157-23577 (SAO)

137-17222-  
 NOT RECORDED  
 201 FEB 27 1974

CONTINUED - OVER

TF:lmc (12)

54 MAR 5 1974

ORIGINAL FILED IN

Memorandum to Mr. W. R. Wannall  
Re: Three Anti-FBI Articles  
Appearing in February, 1974, Issue Of  
National States Rights Party (NSRP)  
Newspaper "The Thunderbolt"

It says a need exists to repeal antigun and similar laws that enable Federal agents to "impose a police state." An analogy is made between alleged FBI tactics and Russian "secret police" tactics. The article closes by urging readers to refuse to answer questions from "federal agents."

The second article is a reprint from the "Atlanta Journal," 5/15/73 issue, by Jack Nelson, captioned "FBI's Hoover Called 'Not Of Sound Mind.'" The article essentially states that wiretap files located by the FBI in a White House safe were kept from former Director Hoover because he was "not of sound mind in his last years." Former FBI official William Sullivan reportedly turned the files over to then Assistant Attorney General Robert Handian, before "Hoover forced Sullivan to retire from the FBI on October 6, 1971," since the late Director "could not be trusted to keep the records confidential." Sullivan is quoted as saying former Director Hoover "was a master blackmailer.... with considerable finesse, despite the deterioration of his mind."

The third article is captioned "FBI Frameup Fails." It relates that George M. Hoover, a member of the Secret Army Organization (SAO) was convicted last year of firing into the home of a "Marxist radical" of San Diego, California. This conviction was overturned on appeal on the basis the jury should have been informed the sole witness testifying against Hoover was a "paid FBI informant." This informant is identified as Howard Berry Godfrey, and the article alleges Godfrey "constantly encouraged violence," was "allowed" by the FBI to participate in acts of violence, and used "entrapment" to involve Hoover in the shooting incident. It is stated this successful appeal by Hoover of his "frameup" is an "outstanding victory for patriots everywhere," and exposes "how far Government agents will go to wreck patriotic groups."

CONTINUED - OVER

Memorandum to Mr. W. R. Wannall  
Re: Three Anti-FBI Articles  
Appearing in February, 1974, Issue Of  
National States Rights Party (NSRP)  
Newspaper "The Thunderbolt"

SAO is a now defunct organization formed in San Diego, California, in 1971 as an anticommunist, paramilitary group. SAO intended to conduct intelligence-type investigations and to offer urban guerrilla training for use against "left-wing groups and suspected enemies of the U. S."

Godfrey was a San Diego Division extremist informant from 12/6/68 to 11/20/72. He was targeted to penetrate the SAO and subsequently became a SAO leader. We have no confirmed information ~~in our files~~ indicating his actual participation in "entrapment" were raised by the defense along this line during ~~no other~~ <sup>Moover's trial</sup> and these allegations were refuted or explained in open court. Godfrey's testimony was instrumental in achieving successful prosecutions against several SAO members, and thereby producing the demise of the SAO.

Copies of the above three articles are attached.

ACTION:

None. For information. This newspaper has a small circulation aimed at its white hate membership. We are not refuting the allegations therein as to do so would serve no useful purpose and would merely prompt the NSRP to prolong these attacks.



# FBI Turned Into Secret Police

J. EDGAR HOOVER  
WAS A MENTAL CASE  
AND A BLACKMAILER

For many years, William C. Sullivan was assistant director to J. Edgar Hoover at the FBI.

In fact, Sullivan was the main public spokesman for the FBI and Hoover, except on those

occasions when Hoover personally spoke. Sullivan often spoke to conventions and important meetings in behalf of Hoover. If any man on the inside ever knew what Hoover really was, it was Assistant Director of the FBI William C. Sullivan.

William C. Sullivan gave a long written report to the White House in which he revealed that J. Edgar Hoover was not of sound mind in his last years. This was a long report which spelled out many of Hoover's illegal activities. He also told how Hoover kept files on congressmen and senators and blackmailed them during the forty eight years that he headed the FBI.

It is bad enough for a man to be a blackmailer and of unsound mind, but much worse when that man is the head of the nationwide secret police that has files on over half the American people.

Jew Daniel Ellsberg stole military secrets and has been accused of giving them to Russia. Yet, Hoover refused to investigate Ellsberg because of his friendship with Ellsberg's father-in-law, Jew Louis Marx. It is tragic when the chief of the secret police is surrounded with Jews.

William C. Sullivan gave his report to the White House. Then, the Senate Watergate Committee was given the report by John Dean, 3rd. The Watergate Committee has suppressed the Sullivan report ever since. They don't want the people to know the truth about how the FBI has been used to commit burglary, perjury, and break other laws in persecuting loyal White patriots throughout the country for many years. It would be well for every person to write to the senators on the Watergate Committee and demand that they release and publish the full text of the Sullivan Report which exposes the evils of the FBI.

A federal court recently ordered the FBI to turn over some of its documents on investigations to a reporter. The documents showed that the FBI had been illegally working for years and years not only to spy upon rightwing patriotic organizations, but to also sabotage them. The only leftwing organizations sabotaged by the FBI were those that had splintered and broken away from the discipline of the main communist movement.

137-17222 -

Enclosure

# FBI's Hoover Called "Not Of Sound Mind"

By JACK NELSON  
WASHINGTON (LAT) —  
Wiretap files located by the  
FBI in a White House safe  
were kept from J. Edgar  
Hoover because he was "not  
of sound mind" in his last  
years, William C. Sullivan,  
former FBI assistant director  
told the Los Angeles Times  
Monday.

Sullivan said that because  
the late FBI director "could  
not be trusted" to keep the  
files confidential Sullivan  
turned them over to Assistant  
Atty. Gen. Robert Mardian be-  
fore Hoover forced Sullivan to  
retire from the FBI on Oct. 6,  
1971.

Sullivan, now director of the  
Justice Department's office of  
national narcotics intelligence,  
said John N. Mitchell, who  
was attorney general at the  
time, ordered that the files be  
given to Mardian.

Acting FBI Director. Wil-  
liam B. Ruckelshaus quoted  
Mardian as saying he trans-  
ferred the files after Sullivan  
warned that Hoover "might  
use the records in some man-  
ner" against President Nixon  
and Mitchell.

RUCKELSHAUS said Sulli-  
van did not "affirm" Mard-  
ian's claim in a statement to  
the FBI. But Sullivan told the  
Times he and Mardian did  
agree that Hoover might use  
the files for "some ill-conceiv-  
ed purpose" against govern-  
ment officials. "I don't specifi-

cally remember mentioning  
the President," Sullivan said,  
"but we certainly had the  
President in mind."

Sullivan, who feuded with  
Hoover over FBI policy mat-  
ters in the last few years be-  
fore the director's death in  
May 1972, said that the wire-  
tap records never were a part  
of the FBI's officially record-  
ed files.

"Hoover didn't want the  
records in the official file,"  
Sullivan said. "He told me to  
keep them myself and have  
them ready for him, available  
any time he wanted them. I  
had them in a file cabinet in  
my office, but they were  
never serialized or recorded  
in the FBI files."

Sullivan said that when Jus-  
tice Department officials who  
knew of the wiretap records  
learned he was leaving "they  
were very upset and under-  
standably because they could  
no longer depend on Hoover.  
He had been leaking stuff all  
over the place. He could no  
longer be trusted. So I was in-  
structed to pass the records to  
Mardian."

HOOVER, who had been  
under considerable criticism  
for his administration of the  
FBI, was concerned about  
being fired as director and  
kept the records "to keep  
Mitchell and the others in  
line," Sullivan said.

That fellow was a master  
blackmailer and he did it with  
considerable finesse despite  
the deterioration of his mind,"  
Sullivan said.

"He always did that sort of  
thing. The moment he would  
get something on a senator  
he's send one of the errand  
boys up and advise the sena-  
tor that we're in the course of  
an investigation and we by  
chance happened to come up  
with this data on your daugh-  
ter. But we wanted you to  
know this — we realize you'd  
want to know it. But don't  
have any concern, no one will  
ever learn about it. Well,  
Jesus, what does that tell the  
senator? From that time on  
the senator's right in his prob-  
ect."

Sullivan said that neither  
Mitchell nor Mardian ever  
specifically told him that they  
did not want Hoover to have  
the files because he could not  
be trusted. But Sullivan said  
he could "read this between  
the lines.

"NEITHER MARDIAN nor  
Mitchell trusted him but they  
didn't want to say that," Sulli-  
van said. "Hoover wasn't of  
sound mind — as a matter of  
fact a high administration  
official once said Hoover has  
been of unsound mind for the  
past few years. Everybody  
who had anything to do with  
Hoover knew that he was no  
longer rational. He was doing  
the strangest things, like  
going into a rage."

37-17232

Enclosure

# FBI Frameup Fails

## CALIFORNIA PATRIOT FREED IN FBI FRAMEUP CASE

Mr. George M. Hoover was a member of the now defunct right-wing "Secret Army Organization." Hoover, age 37 of Santee, California, was convicted last year of firing into the home of a Marxist radical named Peter Bohmer of San Diego.

It was later admitted by the federal prosecution that an FBI pimp named Howard Berry Godfrey had infiltrated the Secret Army. He had driven the car from which the shots were fired. Therefore the California Fourth District Court of Appeals ruled to overturn Hoover's conviction. Judge William T. Low said the jury should have been informed that the sole witness testifying against Hoover, and driver of

the car, was a paid FBI informer.

It was also charged that the pimp, Howard Godfrey, was the chief "firebrand" in the Secret Army and constantly encouraged violence. The FBI allowed Godfrey to participate in the shooting, several firebombings and burglaries before they arrested several others using Godfrey as their main witness against them.

Godfrey was so convincing that he rose to Assistant State Coordinator of The Secret Army. Through acts of violence he was able to prove his "loyalty" to the organization. The court deemed this an act of "entrapment." The FBI pimp was the provocateur of the acts of violence and his FBI superiors had the power to stop them before they occurred.

## RIGHT-WING VICTORY

This important case represents an outstanding victory for Patriots everywhere. The victory of George M. Hoover over this FBI frameup helps to expose how far government agents will go to wreck patriotic groups. The disturbing part of this is that the FBI will itself break the law, with acts of violence, in order to maneuver innocent patriots into a trap, where they can then be framed by lying paid pimps testifying in court.

While this sort of skullduggery has been going on for some time, the true facts behind it all are just now coming to light. We have all read the chilling accounts of secret police terror in Russia and now we witness the very same thing taking place right here in this country.

137-17222 -

[Enc: 200

Mr. J. B. Adams

June 28, 1975

Legal Counsel

PETER BOHMER, et al., v.  
RICHARD MILROUS MERON, et al.  
(U.S.D.C., CALIFORNIA)  
CIVIL ACTION NO. 75-4-T

In captioned civil action plaintiffs Peter Bohmer and Paula Thary allege that defendants conspired to deprive them of rights, privileges and immunities secured to them by the Constitution and laws of the United States. Defendants include SAC Rex L. Schroder, San Diego, former San Diego ASAC Clark F. Brown, presently assigned Inspection Division, SA C. Jordan Naylor and SA Earl M. Peterson, San Diego, former SA Steven L. Christensen, and Howard Barry Godfrey, a former San Diego informant. A litigation report was submitted to the Department by memorandum to the Assistant Attorney General, Criminal Division, dated 5/23/75.

On 6/13/75, Benjamin C. Flanagan, Senior Trial Attorney, Special Litigation Section, Criminal Division, advised that former San Diego FBI informant Howard Barry Godfrey, who reported on rightist activities, had requested Departmental representation in this civil action and that the Department has agreed to represent Mr. Godfrey. Mr. Flanagan asked whether this Bureau had any objection to Mr. Godfrey's representation by the Department.

Enclosure (1)

① 137-17222

~~1 - SAC, SD~~

1 - 100-470202

1 - Mr. Wannall

1 - Mr. Dulladway

2 - Mr. Mintz

1 - Mr. Latorno

GML:kiw

(9)

JUL 24 1975

137-17222  
NOT RECORDED  
JUL 10 1975  
(CONTINUED OVER)

ORIGINAL FILED IN 137-17222-9

Memo to Mr. J. B. Adams  
Re: Peter Bohner, et al., v.  
Richard Milhous Nixon, et al.  
Civil Action No. 75-4-T

The attached memorandum to the Department indicates we have no objection to the Department affording Mr. Goadrey representation as long as his interests do not conflict with the interests of defendant FBI personnel.

RECOMMENDATION:

That the attached memorandum to the Assistant Attorney General, Criminal Division, be approved and sent.

6/5/75

AIRTEL

AIRMAIL

TO: DIRECTOR, FBI (100-461715) (100-470202)  
ATTN: LEGAL COUNSEL DIVISION

FROM: SAC, SAN DIEGO (62-2248) (P)

PETER BOHMER, ET AL  
versus  
RICHARD MILHOUS NIXON, ET AL  
(United States District Court  
San Diego, California)  
CIVIL ACTION NO. 75-4-T

Re your call, 6/4/75.

HOWARD BARRY GODFREY is a defendant in captioned case. He has directed a communication to the U.S. Justice Department requesting that he be represented by the Justice Department attorneys in this law suit. GODFREY was a paid informant of the FBI during the period concerned by the allegation in captioned suit.

It is the recommendation of the San Diego Office that the Justice Department represent GODFREY as an agency relationship existed. Also GODFREY's defense by Departmental attorneys would establish continuity to the answers to the complaint. Finally GODFREY was under the impression that his role as an FBI informer would not be made public and place him in the current position of a defendant in a civil action.

3 - Bureau  
1 - San Diego  
AAR/BMP:kab  
(4)

137-17222-  
NOT RECORDED

46 JUL 10 1975

Assistant Attorney General  
Criminal Division

June 24, 1975

Director, FBI

137-17222

- 1 - Mr. Wannall
- 1 - Mr. DuHadway
- 2 - Mr. Mintz
- 1 - Mr. Laturno

PETER BOLESER, et al., v.  
RICHARD F. DUBOSE HUYEN, et al.  
(U.S.D.C., CALIFORNIA)  
CIVIL ACTION NO. 75-4-T

On June 13, 1975, Mr. Flannagan of your office advised that former San Diego FBI informant Howard Barry Godfrey, who reported on rightist activities, had requested Departmental representation in this civil action and that the Department has agreed to represent Mr. Godfrey. Mr. Flannagan asked whether this Bureau had any objection to Mr. Godfrey's representation by the Department.

For your information, we have no objection to the Department affording representation to Mr. Godfrey as long as his interests do not conflict with the interests of defendant FBI personnel. In the event such conflict arises, we do not feel it would be proper or appropriate for the Department to represent him. See Code of Professional Responsibility, Canon 5, Ethical Considerations EC 5-14 through 19.

① 137-17222  
~~1-100-467715~~  
1 - 100-470202  
GML:kiw  
(11)

DUPLICATE YELLOW

ORIGINAL FILED IN 100-470202-1715

SSC Request 1/20/76  
Item 2 (Re: Howard Berry Godfrey)  
Volume I

Access



UNITED STATES GOVERNMENT

# Memorandum

TO : DIRECTOR, FBI

DATE: 8/10/67

FROM : SAC, SAN DIEGO (137-1643) (P)

SUBJECT: HOWARD BARRY GODFREY  
~~CONF. INFT.~~

*See index*

*Circle*  
*4*  
*3*  
*BLM*  
*Rogers*  
*T. J. ...*  
*S. ...*

GODFREY has furnished valuable information in the past and is being designated a Symbol Number Informant of the San Diego Office. The following information is submitted pursuant to Bureau instructions:

I. INFORMANT'S NAME AND ALL ALIASES

HOWARD BARRY GODFREY

II. SYMBOL NUMBER ASSIGNED

~~XXXXXXXXXX~~

III. ADDRESS AT WHICH CONTACTED

Informant is contacted in the downtown area of San Diego in the vicinity of Tenth and C Street, San Diego, California.

IV. RESIDENCE ADDRESS

4582 Maple Street  
La Mesa, California

REC-78

*N 137-17222-1*

V. DESCRIPTION

MCT-5

16 AUG 14 1967

Race	White
Sex	Male
Date of Birth	7/1/43
Place of Birth	Portsmouth, England
Height	5' 10"
Weight	160 pounds
Hair	Brown

*FRS*  
~~CONF. CONTROL~~

- ② - Bureau (REGISTERED MAIL)
- 2 - San Diego

CJN:cav  
(4)

*Throughout " " indicates symbol number deleted.*

62 AUG 22 1967

*Fred C. ...*  
*10/10*

SD 137-1643

Build	Medium
Marital Status	Married
Social Security Number	564-56-5825

VI. DATE DESIGNATED INFORMANT

August 10, 1967

VII. ESTIMATE OF RELIABILITY

As far as has been determined through association in the past, this informant has not furnished any false information.

VIII. EMPLOYMENT

Informant is currently employed at the Pacific Telephone and Telegraph Company with offices located at Ninth and C Street, San Diego, California. A review of his employment record at the Telephone Company on 5/10/67 reflected no derogatory information. His present duties include the testing of various equipment used by the Telephone Company in the building located at Ninth and C Street.

IX. PAST ACTIVITIES

This informant is not known to have any criminal record nor to have been involved in any criminal activities in the past.

X. IDENTIFICATION RECORD

Identification Record request submitted 3/24/67 was returned 3/27/67 marked "Unable to identify in Criminal Files." Identification Record request submitted 5/9/67 was returned 5/11/67 marked "Unable to identify in Civil File or Criminal Files."

XI. CRIMINAL ASSOCIATES

Informant has been a gun hobbyist all of his life and was also trained in the use of explosives while serving in the United States Army from 1/18/62 to 1/17/63. Because of this background he has a thorough knowledge of firearms, ammunition and various explosive devices. Although he does not have any close associates who would be considered to be known criminals, he maintains acquaintance with numerous individuals who own and operate gun stores and also other people who are interested in buying and selling firearms and military type equipment. His interest and associations have put him into contact with numerous individuals of possible interest to this Bureau both because of possible theft of government property and also due to the interests of various militant and subversive groups who have an interest in obtaining firearms and explosives.

XII. INFORMATION FURNISHED IN THE PAST

1. PATRIOTIC PARTY  
INTERNAL SECURITY - C

The informant was requested to attend a public meeting on 2/24/67 at the House of Hospitality, Balboa Park, San Diego, California. Approximately 100 adults attended this meeting. HOWARD F. CLARK, 1086 Sixth Street, Ramona, California, employed at Convair, San Diego, California and also Treasurer of the International Toastmasters, District #5, conducted this public meeting at which ROBERT B. DE PUGH of Norborne, Missouri, National Co-ordinator of the "Minutemen" was the principle speaker. DE PUGH discussed the aims of the Patriotic Party following which elections were held and informant reported that HOWARD F. CLARK was elected Chairman of the Patriotic Party with a Mr. BRINKER as Vice-Chairman, Mrs. BRINKER Secretary, and GARNER P. DICUS, aka Jerry Dicus, Treasurer. The informant furnished the identity and background information regarding numerous individuals present in attendance at this meeting.

2. MINUTEMEN - INFORMATION CONCERNING  
INTERNAL SECURITY

Informant advised that he attended a meeting on 3/4/67 at the residence of VICTOR WALTON, 5549 Kiowa Drive, La Mesa, California at which 43 people were present. The main speaker of the evening was BERTRAND L. COMPARET, a local San Diego attorney with office at 525 C Street and residence at 4930 Mansfield, San Diego, California. COMPARET was identified by the informant as author of the book "Your Heritage" and commentator on radio programs for stations XERB, KTYM, and KBIF. The informant reported the theme of COMPARET's talk to be on the history of Isreal and of an anti-Semetic nature. Numerous individuals present were identified by informant including TROY HAUGHTON.

Through subsequent association of the informant with TROY HAUGHTON, Western Regional Co-ordinator of the Minutemen, who resides in San Diego, California, informant learned that HAUGHTON is anxious to purchase automatic weapons of all types. HAUGHTON displayed to informant a new 308 German rifle and indicated he was extremely interested in obtaining Browning automatic rifles and any sub-machine guns that might be available. HAUGHTON indicated he had been purchasing materials including guns and ammunition from GERALD T. GIYER, who resides at 9467 Riverview, Lakeside, California. Informant identified GIYER as a well known amateur gun collector in the San Diego area.

3. UNKNOWN SUBJECT;  
THEFT OF AUTOMATIC WEAPONS,  
MADISON HIGH SCHOOL, ROTC,  
SAN DIEGO, CALIFORNIA  
2/24 - 27/67  
TGP

During February, 1967, two Browning automatic rifles, one .30 caliber machine gun and 5,000 rounds of .22 caliber ammunition were stolen from

SD 137-1643

the office of the ROTC, Madison High School, San Diego, California. The above guns were subsequently discovered to be buried in a remote area east of El Cajon, California and were recovered and returned to the school. Investigation to locate the ammunition was conducted. On 4/13/67, informant advised that he had observed GERALD GIYER selling large quantities of .22 caliber ammunition at a swap meet at a drive-in theater in El Cajon, California during a recent weekend. Investigation was conducted to determine if this ammunition was identical with that stolen from the ROTC office; however, no conclusion could be reached inasmuch as the ammunition could not be identified.

Informant has furnished numerous copies of articles and material obtained by him from the residence of TROY HAUGHTON. The material deals primarily with instructions regarding military type operations as well as considerable anti-Semetic literature.

On 7/27/67, informant reported that he had accompanied BILL CLAY, active in Minutemen activities, on the previous weekend when CLAY traveled throughout the remote areas east of San Diego, California on various Indian Reservations during which time CLAY was attempting to discover abandoned mines and any other appropriate areas deemed to be useful in storing arms caches. Informant reported that during this time while with CLAY, CLAY referred to the theft of Browning automatic rifles, a machine gun and ammunition stolen from the ROTC at Madison High School during February, 1967. CLAY said that if these weapons had been hidden better they would never have been found by Police Officers. Informant reported that CLAY did not specifically say he knew who had been responsible for the theft of these weapons and ammunition but did give the general impression that he had such knowledge.

4. "LOVE IN",  
RAMONA OAKS RANCH,  
RAMONA, CALIFORNIA  
5/20 - 21/67  
INTERNAL SECURITY

On 5/19/67, informant advised that several thousand "hippies" planned to congregate at Ramona, California during 5/20 - 21/67. Informant reported that the "Minutemen" planned to create trouble among the "hippies" so that as a result of this, the "hippies" would try to take over the town of Ramona, California.

Informant reported that the idea behind the "Minutemen" participating in the activity was so the people of Ramona would become alert to the fact that "it can happen in their town".

Informant advised that the "Minutemen" planned to spread sugar cubes throughout the town of Ramona to give the impression that the cubes contained LSD. They intended to change highway signs and road markers to create confusion and to direct arriving "hippies" to local Indian Reservations thus creating the possibility of clashes between local Indians and the "hippie groups". Informant said the "Minutemen" planned to collect bags of dog waste material and distribute this throughout the city of Ramona so that the "hippies" would be blamed for this act. All information furnished by informant was furnished to local law enforcement agencies. On the first day of the scheduled "love in" the San Diego County Sheriff's Office and California Highway Patrol established a command post in the vicinity of Ramona Oaks Ranch, Ramona, California following which ten arrests were made of adults and juveniles for possession of marijuana and LSD. A road block was set up in the vicinity by the California Highway Patrol to check on the safety of vehicles traveling in the vicinity. It was reported that this apparently discouraged a number of individuals from attending the "love in" at Ramona Oaks Ranch as the attendance did not exceed more than 300 or 400 participants. The informant reported following this activity that the members of the "Minutemen" group who attempted to cause trouble in the area were dissuaded because of the law enforcement officers being present in the community.

SD 137-1643

XIII. CAPABILITY OF BEING USED OUTSIDE THE SAN DIEGO DIVISION

Due to the informant's residence in La Mesa, California and full time employment at San Diego, California, he has indicated he does not desire to receive assignments outside of this local area. He has indicated, however, that he would make his services available for any important matters which might take place in other areas.

XIV. INFORMATION REFLECTING INFORMANT TO BE EMOTIONALLY UNSTABLE, UNRELIABLE, OR TO HAVE FURNISHED FALSE INFORMATION

No information has been developed during contacts with informant to date which indicate the informant is unstable or unreliable. No information has been developed that would indicate he has furnished any false information.

Inasmuch as the informant has furnished information of both a security and criminal nature, he will be operated as a Criminal Informant, however, security type information will continue to be received from him.

SAC, San Diego (137-1043)

1/12/68

Director, FBI (137-17222) - 2

REC-21

~~CONFIDENTIAL~~

C

Reurlet 1/5/68.

Your request to pay captioned informant at the rate of \$125 per month on a regular basis is not approved. This individual was developed by you on 8/10/67, and since that time has furnished, almost exclusively, security-type information. The Theft of Government Property-type information being furnished, while of a criminal nature, appears to have a direct relationship with the activities of security subjects.

In view of the newness of this informant and the fact that virtually all information being furnished is of a security nature, you should consider redesignating this individual as a security informant in accordance with provisions set forth in Section 107, Manual of Instructions.

Authority is granted, effective with the date of this letter, to pay captioned informant on a strictly C.O.D. basis the sum of up to \$200 in accordance with provisions set forth in Section 108 J2, Manual of Instructions.

- 1 - M. J. Rozamus, 906 9th & D
- 1 - M. F. Row, 6221 IB

MAILED 22  
 JAN 12 1968  
 COMM-FBI

NOTE: Captioned individual was approved as an informant 8/10/67. Since that time all information furnished by him relates to various Internal Security subjects and Internal Security groups under investigation by this Bureau. Authority to make regular payments as a criminal informant should not be approved at this time. It is recommended, however, that a new \$200 SAC authority be approved with payments to be made on a strictly C.O.D. basis.

ABF:paf  
(6)

- Tolson \_\_\_\_\_
- DeLoach \_\_\_\_\_
- Mohr \_\_\_\_\_
- Bishop \_\_\_\_\_
- Casper \_\_\_\_\_
- Callahan \_\_\_\_\_
- Conrad \_\_\_\_\_
- Felt \_\_\_\_\_
- Gale \_\_\_\_\_
- Rosen \_\_\_\_\_
- Sullivan \_\_\_\_\_
- Tavel \_\_\_\_\_
- Trotter \_\_\_\_\_
- Tele. Rm. \_\_\_\_\_
- Holmes \_\_\_\_\_
- Gandy \_\_\_\_\_

51 FEB 8 1968

MAIL ROOM  TELETYPE UNIT

*Walt*  
*ABF*  
*Ad*



UNITED STATES GOVERNMENT

# Memorandum

TO : DIRECTOR, FBI (137-17222)

FROM : SAC, SAN DIEGO (137-1643) (P)

SUBJECT: CONF. INFT.

DATE: 1/5/68

I recommend that authority be granted to pay the above informant up to \$75 per month for services and \$50 per month for expenses for a period of six months on a COD basis or for expenses to be incurred or services rendered in seeking information at our specific request. This authorization is to be effective January 15, 1968, and letters of progress will be submitted quarterly. My letter of June 15, 1968, will contain my recommendation concerning further payments.

In all contacts with this informant to date there has been no indication on the part of the informant of any emotional instability, unreliability, nor has he furnished any false information.

Informant was designated a PCI on February 27, 1967, and converted to a Criminal Informant on August 10, 1967.

### PAYMENTS

Under authority of Section 108J, Number 2, Manual of Instructions, the following amounts have been paid to the informant as indicated:

- ③ - Bureau (Reg.)
- 1 - San Diego

CJN:ecc  
(4)

let to SD  
1-12-68  
ABF: P

*[Handwritten signatures and initials]*

REC-21

137-17222-2

24

15 JAN 10 1968

35

R

SD137-1643

<u>Date</u>	<u>Period</u>	<u>Amount Paid</u>
3/15/67	2/27-3/10/67	\$ 50.00
5/3/67	3/11-5/1/67	50.00
5/26/67	5/2-5/25/67	35.00
9/1/67	5/26-8/31/67	40.00
11/3/67	9/1-11/2/67	25.00
Total Amount Paid		\$ 200.00

INFORMATION FURNISHED

UNSUB;  
THEFT OF AUTOMATIC WEAPONS,  
MADISON HIGH SCHOOL,  
ROTC, SAN DIEGO, CALIFORNIA  
2/24-27/67  
TGP  
SD52-4585

The following theft of two Browning Automatic Rifles, one .30 Caliber Machine Gun and five thousand rounds of .22 Caliber ammunition from Madison High School, San Diego, California, CI developed information that one, GERALD GIYER was selling large amounts of .22 Caliber ammunition at a swap meet at prices below the San Diego market. Investigation was conducted, however it was impossible to identify the ammunition as being that stolen from the High School.

CI developed association with one, BILL CLAY, active in Minutement Activities in the San Diego area and spent several days with CLAY traveling in remote areas of San Diego and on various Indian Reservations during which time CLAY was attempting

to discover abandoned mines and other appropriate areas deemed useful in storing arms caches. CI reported that during this excursion CLAY referred to theft of the Browning Automatic Rifles and other items stolen from Madison High School. Subsequent investigation conducted in this captioned matter located the Browning Automatic Rifles buried in the remote area which had been previously observed by CLAY.

7  
P. B. ...

PATRIOTIC PARTY  
INTERNAL SECURITY -C

(SD-100-13832)

Informant has attended meetings of the Patriotic Party and specifically has identified individuals present at such groups including ROBERT B. DE PUGH of Norborne, Missouri, National Coordinator of the Minutemen, as speaker at one meeting. CI also furnished the identity of officers elected to the Patriotic Party at a meeting which he attended.

MINUTEMEN-  
INFORMATION CONCERNING  
INTERNAL SECURITY  
SD100-12461

CI is a very active member of the Minutemen Organization in San Diego, California, and has furnished complete details of all Minutemen activities in this area. He has been a close associate of TROY HAUGHTON, the West Coast leader of the Minutemen until his disappearance about six months ago. Since that time informant has continued his association with BETTY HAUGHTON, who is active in organizing Minutemen activities throughout Southern California and publishing much material for distribution through Minutemen contacts. CI furnishes copies of literature published by HAUGHTON and also attends numerous functions of the Minutemen as well as other functions through assignments by BETTY HAUGHTON. He has been extensively developed by the Minutemen because of his knowledge of firearms and use of explosives. He has also been assigned to make frequent visits to the Peace Center operated by the Peace and Freedom Party at San Diego, California, and has associated with individuals in that group to identify them and their activities for information of local Minutemen. In addition, he is frequently contacted

SD137-1643

by individuals seeking assistance in obtaining guns, ammunition and explosives. He has thus been able to identify individuals interested in obtaining weapons and explosives. During recent visit of former Alabama Governor GEORGE C. WALLACE, who spoke at Russ Auditorium, San Diego, California, informant attended this meeting and furnished information regarding identities of persons present as well as reporting that local Minutemen were utilized as doorkeepers and ushers.

"LOVE IN"  
RAMONA OAKS RANCH  
RAMONA, CALIFORNIA  
5/20-21/67  
INTERNAL SECURITY  
SD100-12461

CI furnished information regarding the plans of Minutemen to disrupt meeting of several thousand "hippies" to congregate at Ramona, California, during spring of 1967. Information furnished by CI regarding plans and activities at this meeting were furnished to local police agencies and assisted in the prevention of wide spread rioting in the Ramona area.

PEACE AND FREEDOM PARTY  
INTERNAL SECURITY  
SD100-14061

At the request of BETTY HAUGHTON, on behalf of local San Diego Minutemen Organization, CI has frequented the Peace and Freedom Party Headquarters in San Diego for purposes of identifying members and participants in activities there. He has furnished information about the harassment of this group by the local Minutemen and in addition, has obtained literature and mailing lists and other pertinent information for distribution to the Minutemen Organization. CI makes the information available to the San Diego Division before passing on to Minutemen Organization

SD137-1643

GILBERT O. MC GILL  
POSSIBLE THEFT OF GOVERNMENT PROPERTY  
SD52-4723

CI has identified MC GILL as an individual dealing in guns and ammunition in the San Diego area and determined that MC GILL is dealing in large amounts of ammunition and other explosives. MC GILL has attempted to assist CI in obtaining large amounts of ammunition including hand grenades for use by local Minutemen Organizations.

POLICE COOPERATION  
SAN DIEGO DIVISION

CI furnished information reflecting that officers of the Peace and Freedom Party at San Diego, California, had reported theft of two typewriters to the San Diego Police Department from the Peace and Freedom Party Headquarters. CI was present at the Headquarters on the date of this reported theft and personally observed one of the officers take the two typewriters in question from the building and place them in his personal automobile. This information was furnished to the Burglary Detail of the San Diego Police Department and the theft report confirmed. CI furnished the identity of JOHN SCHOPP as the suspect in the theft of these typewriters.

CI furnished information that local Minutemen planned to make threatening phone calls to police departments and other law enforcement agencies in the San Diego area during a meeting honoring LINUS PAULING. PAULING was being honored by the Peace and Freedom Party at San Diego, California, at a meeting held at the Village Inn. CI advised that these threatening phone calls to place bombs at the Village Inn were for the purpose of disrupting the meeting and no actual bombs would be placed. Inspector EDWARD DE BOLT, San Diego Police Department, advised that the Police Department did receive a bomb threat report

SD137-1643

regarding the above meeting and he was advised of appropriate information received from CI. Inspector DE BOLT advised that the Police Department covered the Peace and Freedom Meeting as indicated above and no bomb was placed there.

CI has identified the residence of WILLIAM KITT, 1929 North 33rd Street, San Diego, as a place where LSD and other narcotics are being purchased and resold in the San Diego area. This information has been furnished to the Narcotics Bureau of the San Diego Police Department.

In addition to the above information set out regarding the activities of the CI it is to be noted that he has volunteered the clerical and secretarial assistance of his wife to the Minutemen organization for the purpose of obtaining additional background information for information regarding the Minutemen activities and work being performed at the Minutemen office, the residence of BETTY HAUGHTON.

This CI has enabled the San Diego Division to follow activities of local Minutemen groups and activities of the Peace and Freedom Party to a very extensive degree. This information would not generally be available to any other sources of the San Diego Division and could not be obtained by Special Agents due to the nature of the information.

This CI has demonstrated resourcefulness and ingenuity in obtaining information and has dedicated a great deal of his time to this work for the Bureau. Information furnished by the CI is believed to be of much greater value than the remuneration which he receives.

It is to be noted that a considerable amount of information furnished by the informant is of a security nature. This information is appropriately disseminated and channeled. It is recommended however, that the informant be continued as a Criminal Informant inasmuch as he was originally developed for this purpose and continues to furnish information in the criminal field.



UNITED STATES DEPARTMENT OF JUSTICE  
FEDERAL BUREAU OF INVESTIGATION

In Reply, Please Refer to  
File No. SD 137-1643

San Diego, California  
December 15, 1967

SYMBOL NUMBER:

CONF. INFT. ~~XXXXXXXXXX~~

BUREAU FILE NUMBER:

137-17222

EMPLOYMENT:

Informant is currently employed at the Pacific Telephone and Telegraph Company with offices located at Ninth and C Streets, San Diego, California. His present duties include testing of various equipment used by the telephone company in the building located at Ninth and C Streets.

DATES OF CONTACT:

CI designated informant on 8/10/67.  
8/11, 23, 24/67;  
9/1, 11, 14, 22, 26/67;  
10/23, 26, 30/67;  
11/3, 6, 7, 27, 29, 30/67;  
12/1/67.

OUTCOME OF CASES NOT PREVIOUSLY COMPLETED:

None.

INFORMATION FURNISHED:

Informant was designated a CI on 8/10/67. A summary of information furnished was sent to the Bureau by letter dated 8/10/67 and is not being repeated in this summary.

MINUTEMEN - INFORMATION  
CONCERNING, INTERNAL  
SECURITY, SD File 100-12461

137-17222-10  
DEC 15 1967

Informant has been furnishing information regarding the activities of Minutemen groups in the San Diego area on a continuing basis for several months. He has been developed by the Minutemen because of his extensive knowledge of firearms and use of explosives. Since August 24, 1967, he has been

*[Handwritten signatures and initials]*

SD 137-1643

asked on a continuing basis by BETTY HAUGHTON, present leader of Minutemen activities in the San Diego area to make frequent visits to the Peace Center, operated by the Peace and Freedom Party. Purpose of the informant's assignment has been to identify individuals participating in activities at the Peace Center and obtain all available literature as well as to secure keys to the office and any files, which keys can be used by the Minutemen to obtain mailing lists and other confidential information. In addition to informant's assignments in attending meetings and other activities for the Minutemen, he is frequently contacted by individuals seeking assistance in obtaining guns, ammunition, and explosives. He has thus been able to identify individuals interested in obtaining weapons and explosives.

Informant furnishes literature distributed through local Minutemen sources and has kept this office advised of the activities of BETTY HAUGHTON regarding actions taken by her in an effort to locate her husband, TROY HAUGHTON, who is a National Minuteman leader and who disappeared several months ago.

During the visit of former Alabama Governor GEORGE C. WALLACE, who spoke at Russ Auditorium, San Diego, California, the night of 11/2/67, informant attended this meeting and furnished information regarding the identities of several persons present as well as reporting that local Minutemen were utilized during this meeting as door keepers and ushers..

PEACE AND FREEDOM PARTY  
INTERNAL SECURITY  
SD File 100-14061

On 10/26/67, informant advised that at the request of BETTY HAUGHTON, in behalf of the local San Diego Minutemen organization, he has been visiting the new office of the Peace and Freedom Party located at 5728 El Cajon Boulevard, San Diego, California. The purpose of informant's contacts at this Center has been to identify members and people interested in the activities of the Peace and Freedom Party as well as to obtain mailing lists and obtain any other information of value regarding activities occurring there. Informant stated that at the request of Dr. FRANCIS HALPERN,



SD 137-1643

Chairman of the Peace and Freedom Party, who is also a professor at the University of California, San Diego, California, informant registered as a member of the Peace and Freedom Party on Certificate Number 524401 while visiting the Peace Center on 10/21/67 and identified the registrar as FRITJOF P. THYGESON. Informant has participated in numerous activities at the Peace Center and has furnished information including mailing lists and addresses of members of that Party to the San Diego Office. He has also furnished information regarding activities of the local Minutemen to cause disturbances and create a continuing harrassment of the Peace and Freedom Party activities.

GILBERT O. MC GILL  
POSSIBLE THEFT OF GOVERNMENT  
PROPERTY, SD File 52-4723

On 9/1/67, informant identified GILBERT O. MC GILL as an individual known to be dealing in guns and ammunition on a confidential basis with anyone having necessary cash. MC GILL was identified as an employee of the Pacific Telephone Company at San Diego, California, and offered to assist informant in obtaining 10,000 rounds of 30.06 ammunition for informant and indicated this could be obtained by MC GILL in sealed, water-tight metal containers in clips ready for firing. MC GILL indicated to informant that he could also assist him in obtaining hand grenades. MC GILL indicated to informant it was possible for him to obtain the ammunition in sealed metal cartons only when large Navy ships were in the San Diego Bay for repair. He indicated that he could get big lots of ammunition only at that time, but could obtain regular cartons at any time they were desired. A background investigation was conducted of MC GILL, however no prosecution is pending at this time.

POLICE COOPERATION  
SAN DIEGO DIVISION

On 11/27/67, informant advised that during the Thanksgiving holidays he visited the Peace and Freedom Party Headquarters on El Cajon Boulevard, San Diego, California on 11/23/67. He reported that during this visit, it was learned that an alleged burglary had occurred at the premises and that a loss of two typewriters had occurred in addition to having the telephone lines of the office pulled from their

SD 137-1643

installations. Informant advised that the theft had been reported to the San Diego Police Department by JOHN SCHOPP, Executive Board Member of the Peace and Freedom Party on 11/23/67. Informant further advised that early in the morning on 11/23/67, he had personally observed JOHN SCHOPP to remove two typewriters from the Peace and Freedom Party Headquarters Building and place these typewriters in his automobile. Informant advised that it was his feelings SCHOPP had taken these typewriters and reported them stolen in order to obtain publicity for the organization. Records of the San Diego Police Department reflect that the Peace and Freedom Party, San Diego, California, reported a burglary of their office on 11/23/67, indicating that two typewriters had been stolen and telephones in the office pulled from their installations. Investigation conducted failed to develop any suspects.

On 11/28/67, Detective PAUL YBARRONDO, Burglary Detail, San Diego Police Department, was advised of the fact that JOHN SCHOPP was a possible suspect in the theft of the typewriters and the Police Department was furnished sufficient detail to enable them to conduct an appropriate investigation in this matter.

On 9/1/67, information was furnished by informant reporting that a bookmaker identified only as "Charlie" was operating from a used clothing store located next to the Villa Inn at 45th and Market Streets, San Diego, California. This information was orally furnished to the San Diego Police Department for appropriate action.

On 12/1/67, informant advised that he had been in contact with LYLE J. MANNING, a local Minuteman member, who had advised him that the Minutemen intended to telephonically report to the San Diego Police Department and other police agencies on that date, that a bomb would be placed at the Village Inn as a protest against the Peace and Freedom Party holding a meeting at the Village Inn. Informant reported that MANNING indicated the Minutemen had no intention of placing any bombs, but that their intention was to make false reports to police and other authorities to create a disturbance. This disturbance was to be created in connection with an activity of the Peace and Freedom Party who had sent out invitations for a dinner to be held at the Vacation Village Hotel at San Diego, California at 7:00 p.m. on 12/1/67 to

SD 137-1643

honor Dr. LINUS PAULING, Nobel Peace Prize Winner and Professor of the University of California at San Diego, California. Informant reported that the Minutemen intended to create a disturbance at this dinner because of PAULING's well known communist background.

On 12/1/67, Inspector EDWARD DE BOLT, Police Department, San Diego, California, advised that the Business Office of the Police Department received an anonymous telephone call that date alleged to be from a member of the Minutemen. The anonymous telephone call reported that someone was going to blow up the Village Inn on the evening of 12/1/67.

Inspector DE BOLT was furnished information concerning the Peace and Freedom Party dinner to honor Dr. LINUS PAULING and Inspector DE BOLT advised that the San Diego Police Department would have the necessary coverage at the Vacation Village Inn in the event a bomb was placed there.

On 12/4/67, Inspector DE BOLT advised that the Police Department had covered the Peace and Freedom Party Affair at the Vacation Village and that no bomb had been placed there.

The above information furnished by this informant has been of considerable value to the San Diego Division and could not have been obtained through other sources.

RECOMMENDATION:

During the inspection of the San Diego Division which occurred in November, 1967, informant was rated as excellent by the Inspector. It is highly recommended that this informant be continued.

STABILITY AND  
RELIABILITY:

There has been no indication of emotional instability on the part of the informant and as far as can be determined, informant has furnished no false information.



SD 137-1643

contacted him that date advising he could furnish 500 rounds of shot line shells at 4:00 p.m. that date and planned to take this ammunition from the ship. In order not to compromise the informant through an FBI investigation of this matter the above information was furnished to the Security Office of the U. S. Naval Station, at which time it was recommended that a search of all personnel be conducted that day as they were departing the ship for shore leave. CI reported later that same date that he had been contacted by COON, but COON indicated he could not obtain the ammunition from the ship because of increased security measures on board.

On 3/25/68, CI advised that in connection with a nationwide telephone strike under consideration by telephone employees, TERRY FINK, Western Electric Union representative, San Diego, California, had been talking about sabotage to telephone company equipment in order to impress upon the telephone company the need for negotiating with telephone company unions. Specific recommendations were made regarding use of rifles to shoot insulators off of telephone lines in rural areas and also sabotaging telephone lines in the city by cutting lines where possible. It was indicated this tactic was the only means considered feasible to stop telephone transmissions to enforce the demands of union employees. This information was immediately furnished to Special Agent SAM BEASLEY, Security Office, Pacific Telephone Company, San Diego, California.

MINUTEMEN - INTERNAL SECURITY  
INFORMATION CONCERNING  
SD File 100-12461

On a continuing basis the informant has furnished copies of all literature and information printed and published by Minutemen sources in the San Diego area including the initiation of the publication of the periodical "TARGET" published in the San Diego area by BETTY HAUGHTON for distribution to all active Minutemen and super patriots. On 1/3/68, the informant advised that during the appearance of the Moscow Circus at the San Diego International Sports

SD 137-1643

Arena several Minutemen participated in picketing the circus and marched up and down in front of the arena carrying signs and placards. CI furnished the identities of those members of the Minutemen who participated in these activities.

On 4/22/68, CI reported that he, at the request of BILL CLAY, who has taken over active leadership of the Minutemen inasmuch as BETTY HAUGHTON has ceased active leadership of the Minutemen activities, participated in placing several large signs over prominent overpasses spanning freeways in the San Diego area where they would be observed by the morning rush hour traffic on 4/22/68. CI reported the individuals involved in this activity which involved the placing of the above signs constructed by BILL CLAY bearing inscriptions such as, "Communist Traitors Beware". CI reported that the signs were placed in prominent places through the use of two-way radios in vehicles so that the individuals placing the signs could avoid being apprehended.

In addition to the above information, CI has continuously furnished information from Minutemen activities particularly dealing with contemplated destruction or assault which did not in fact take place. It is to be noted that this informant is the only source of information in the San Diego Division actually engaged in Minutemen activities.

MIKE VEJVODA, aka.,  
Paul Anthony;  
BOB JONES;  
POSSIBLE THEFT OF GOVERNMENT PROPERTY  
SD file 52-4918

On 4/15/68, informant advised that MIKE VEJVODA, a young Cuban recently moving to San Diego from the Los Angeles area, has been actively attempting to establish himself in the Minutemen activities in San Diego. VEJVODA was identified by informant as the San Diego Chief Supporter of "Staff" in this area.

VEJVODA was reported by informant to be extremely interested in encouraging accumulation of arms and ammunition

SD 137-1643

by private citizens in the San Diego area. VEJVODA was accompanied by informant to Hawthorne, California to attend a gun show on March 30 - April 1, 1968, at which time informant was introduced by VEJVODA to several acquaintances in the Los Angeles, California area. One such individual was BOB JONES, identified as a member of the 40th Armoured Division National Guard. Informant reported that VEJVODA has been in contact with BOB JONES in a continuing effort to obtain two Browning Automatic Rifles which he plans to have stolen from the 40th Armored Division Armory. This information has been furnished to the Los Angeles Division who in turn has advised appropriate military authorities, in that area.

On 6/5/68, CI furnished the identity of MIKE VEJVODA as a very likely suspect in the shooting of ROBERT KENNEDY in Los Angeles, California on 6/4/68 inasmuch as the physical description of the individual apprehended following the shooting was almost identical to the physical description of MIKE VEJVODA. Informant conducted the subsequent investigation which determined that VEJVODA was in the San Diego area on the morning of 6/5/68 and therefore could not have been the individual in custody in Los Angeles in connection with that assault.

JERRY DICUS  
INTERNAL SECURITY - C  
SD File 100-14017

On 5/3/68 and 5/27/68, informant furnished information relative to the activities of DICUS who has been actively engaged in the past in Minutemen activities and also in attempting to encourage organization of anti-Negro and anti-semitic activities in the San Diego area. Informant has developed information reflecting that DICUS is no longer to be contacted by any members of the Minutemen organization in the San Diego area and reported that DICUS has been having personal problems which caused the separation of he and his

SD 137-1643

wife during recent weeks. Background information regarding DICUS was developed including the location of his mailing address at Post Office Box 3393 Hillcrest Station, San Diego, California.

RECOMMENDATION:

Informant has consistently and conscientiously demonstrated a high degree of intelligence as well as interest in assisting the FBI in the gathering and reporting of information to this office. It is highly recommended that this informant be continued.

STABILITY AND  
RELIABILITY:

There has been no indication of emotional instability on the part of the informant and as far as can be determined, informant has furnished no false or misleading information.



UNITED STATES GOVERNMENT

# Memorandum

*File*

TO: SAC, *San Diego* (Your file \_\_\_\_\_) DATE: *9/23/68*

FROM: Director, FBI (Bufile and Serial *137-17222*)

Room No. *7501*

Post in file and destroy 0-1 (For SOG use only)

SUBJECT: *[REDACTED]*

1. Bufiles indicate this case is delinquent. Give specific reason for delinquency.

\_\_\_\_\_  
\_\_\_\_\_

2. DATE  airtel  letterhead memo  submitted  
 report  letter  90-day progress letter  will be submitted \_\_\_\_\_

Reporting employee \_\_\_\_\_

3. If valid reason exists for not submitting report at this time, state reason specifically and when report will be submitted \_\_\_\_\_

4. Status of  Appeal  Inquiry  Investigation  Prosecution

airtel  letterhead memo  
 5. Submit  report *Bufile 62-107261-46-5*  letter  90-day progress letter by \_\_\_\_\_

*See Bufile 100-1246*

SEARCHED	INDEXED
SERIALIZED	FILED
OCT 1 1968	
FBI - SAN DIEGO	

*File*

(Place reply hereon and return to Bureau. Note receipt and acknowledgment on top serial in case file.)

*(over)*

U. S. GOVERNMENT PRINTING OFFICE : 1955 O - 781-652 907-748

~~\_\_\_\_\_~~ just change employment  
and his current status undetermined due to  
change in working schedule and time available  
to continue in assisting Bureau, if CI  
able to continue to be active in minute man activities  
he will be converted to SI.

Since CI is presently in training status until  
middle of Oct. and schedule unknown until training  
completed, no change being made at this time and  
BU will be advised of any change in status within  
45 days -

SEP 29 1968

INCONS OCT 18 1968

Memorandum

TO : DIRECTOR, FBI (62-107261)

DATE: 8/2/68

FROM : SAC, SAN DIEGO (100-12461) (P)

SUBJECT: MINUTEMEN  
IS -- MISCELLANEOUS

Re SAC Letter 68-38, dated 7/2/68.

INFORMANT COVERAGE - MINUTEMEN:

I. EXISTING INFORMANTS WHO REPORT EXCLUSIVELY ON MINUTEMEN

None

II. EXISTING INFORMANTS WHO REPORT ON SEVERAL ORGANIZATIONS

CONF. INFO. [redacted] San Diego file 137-1643  
Bufile 137-17222

Above informant was opened as a PCI in the San Diego Division on 2/27/67, and for a while furnished information relating to theft of firearms. Informant then connected himself with the top echelon of Minutemen members in the San Diego area and has furnished valuable information regarding Minutemen members and the activities of the organization itself in the San Diego area.

Through his connections with the Minutemen he has involved himself in New Left and Black Power activities for the purpose of obtaining intelligence data on these various organizations for the Minutemen. All information derived on these organizations, including Students for a Democratic Society and the Black Panther Group, has been of assistance to the Bureau.

Although above informant has been handled as a criminal informant to date, steps will be taken to convert him to a security informant.

- 2 - Bureau (AM) (REGISTERED)
- 3 - San Diego
- (1 - 137-1643)

AWO:bef.

50 AUG 5 1968

*F. J. [unclear]*  
*Ryan [unclear]*  
*D. [unclear]*

REC-31

8/2/68 137-17222-5  
10 AUG 23 1968  
NOT RECORDED  
178 AUG 23 1968

INT. SEC.

ORIGINAL FILED IN

SD 100-12461

In view of the highly secretive nature of the Minutemen organization, wherein no one member is allowed to know all other members, efforts are being made to develop additional quality informant coverage to insure complete coverage of this organization in the San Diego Division.

The San Diego Division has intensified its investigation into members and suspected Minutemen members for the purpose of determining the total membership in the San Diego area. It is felt that this intensified investigation will also assist in identifying individuals who would be prospects for quality informants.

This program will be closely followed in the San Diego Division.

1 - Mr. T. P. Broken

SAC, San Diego

12/6/68

122

REF-127

Director, FBI (137-17222)

*[Handwritten signature]*

\*

~~\_\_\_\_\_~~

Reurlet 11/13/68.

Authority is granted to change captioned individual from a criminal to a security informant.

Authority is granted to pay captioned individual an amount up to \$75 per month for services rendered on a c.o.d. basis and up to \$25 per month for expenses actually incurred for a period of six months effective 12/1/68.

Concerning your payments to this informant and all informants, you are reminded that payments must be commensurate with the value of the information received; that payments are to be made only for actual expenses incurred in connection with obtaining information for the FBI. In addition, payments should be made in such a manner that the informant clearly understands he is not being paid on a salary basis but rather on a c.o.d. basis.

- 1 - San Diego (137-1642)
- 1 - Mr. M. F. Row (6221 IB)

EPD:fsk  
(6)

*fsk*

*0-1-2-3-4-5-6-7-8-9  
9/28/70*

NOTE:

\*

~~\_\_\_\_\_~~, a white male, 25 years of age and an honorably discharged U.S. Air Force veteran, reveals he is presently undergoing training as a fireman with the San Diego, California, Fire Department. He was designated a criminal informant of the San Diego Office during August, 1967, however, information furnished by him since his development primarily concerns Minutemen activities in the San Diego area. He is the only source of the San Diego Office furnishing such information and

DEC 6 - 1968  
COMM-FBI

- Tolson \_\_\_\_\_
- DeLoach \_\_\_\_\_
- Mohr \_\_\_\_\_
- Bishop \_\_\_\_\_
- Casper \_\_\_\_\_
- Callahan \_\_\_\_\_
- Conrad \_\_\_\_\_
- Felt \_\_\_\_\_
- Gale \_\_\_\_\_
- Rosen \_\_\_\_\_
- Sullivan \_\_\_\_\_
- Tavel \_\_\_\_\_
- Trotter \_\_\_\_\_
- Tele. Room \_\_\_\_\_
- Holmes \_\_\_\_\_
- Gandy \_\_\_\_\_

DEC 12 1968  
*[Handwritten initials]*

NOTE CONTINUED PAGE TWO

*[Handwritten initials]*  
TOP

MAIL ROOM  TELETYPE UNIT

Letter to SAC, San Diego  
RE: SD 1155-S  
137-17222

NOTE CONTINUED:

is well acquainted with Troy Haughton, former West Coast leader of the Minutemen. He continues to obtain and make available to the San Diego Office literature distributed by the Minutemen and actively participates in Minutemen meetings and affairs. As a result of informant's background and knowledge of firearms and explosives, he is cognizant of practically all individuals in the San Diego area who deal in weapons and ammunition. He furnishes information on approximately 20 persons actively engaged in Minutemen and ultra-right wing activities in the San Diego area.

Payments to this informant are justified.

UNITED STATES GOVERNMENT

# Memorandum

TO : DIRECTOR, FBI

DATE: 11-13-68

FROM : SAC, SAN DIEGO (134- ) (P)

*Handwritten notes and signatures in the top right corner, including a signature that appears to be "Dove".*

SUBJECT: HOWARD BARRY GODFREY

CONF. INFO. ~~REDACTED~~

Informant was designated a criminal informant of the San Diego Division on August 10, 1967. He was furnishing primarily criminal information at the beginning of his development, however, he has continued to direct his efforts toward infiltrating the activities of the Minutemen in the San Diego area. \* the only informant in the San Diego area who is able to furnish any information regarding Minutemen activities up to the present time. Due to the Bureau's continuing interest in the Minutemen activities informant, has been encouraged to devote his full time to this activity and it is therefore felt appropriate he should be designated a security informant at this time.

*Handwritten initials "M-3" and "H" on the left margin.*

I recommend that authority be granted to make payments to the above informant up to \$75.00 per month for services plus up to \$25.00 per month for expenses actually incurred for a period of six months effective December 1, 1968.

Background information regarding informant has been set out in San Diego letter to the Bureau dated 8-10-67, (Bufile 137-17222), however, appropriate information is being repeated at this time for background purposes.

## I. CHECK OF FIELD OFFICE FILES

A review of the indices of the San Diego Office fail to reflect any derogatory information regarding informant.

## II. CANVAS OF LOGICAL INFORMANTS

A discrete canvas of all logical informants in the San Diego Division in the Security Field has been made and there is no indication that any of these informants are personally acquainted with the informant. It is to be noted that subject's devotes the majority of his time to Minutemen activities and does not participate in activities of the Communist Party or other subversive groups.

*Vertical stamp on the right margin: "RECORDED COPY FILED IN 137-17222-3"*

REC-46

NOV 15 1968

- (3) - Bureau
  - (1 - 137-17222)
- 3 - San Diego
  - (1 - 137-1643)

CJN:blb

(6)

*Handwritten signature and date "Date" with a date stamp "NOV 13 1968".*

*Handwritten initials and stamps at the bottom right, including "NOV 15 1968" and "RECORDED COPY FILED IN".*

III. PERSONAL HISTORY

Informant is a white male, born 7-1-43, at Portsmouth, England, presently residing at 4582 Maple Street, La Mesa, California. He is presently undergoing training as a firemen with the San Diego Fire Department and has previously been employed at the Pacific Telephone and Telegraph Company, San Diego, California. A review of his employment record at the Telephone Company was made on 5-10-67, at which time it was determined that the employment record contained no derogatory information. Informant has been furnishing information of value to the San Diego Division for approximately 1 1/2 years during which time he has demonstrated himself to be a reliable stable individual, who enjoys a favorable reputation and is believed to be a loyal American citizen with high moral standards and high degree of personal integrity. During his operation as a criminal informant he has demonstrated his ability to develop information in a very discrete manner and has never caused any embarrassment to the Bureau.

IV. CREDIT AND CRIMINAL RECORDS

A review of local credit and arrest records in the San Diego Division has been made and there is no information of a derogatory nature regarding subject's credit history and no arrest record was located. Form FD 165 has previously been submitted to the Identification Division effective 8-1-67.

V. ARMED SERVICES RECORD

The master service file of HOWARD BARRY GODREY, serial number AF19724309, was reviewed on 9-12-67, at the Records Service Division, Air Reserve Personnel Center, Denver, Colorado. The file reflects informant born 7-1-43, at Portsmouth, England. He enlisted on 1-18-62, at Phoenix, Arizona, in the grade of Airmen Basic for Service in the U. S. Air Force for a period of four years. He went on extended active duty on 1-18-62. He was separated from the service in the grade of Airmen Second Class on 1-17-66, after being honorably released from active duty upon completion of his enlistment. He received performance ratings ranging from good to excellent and was recommended for an Air Force career. He did not serve outside the continental limits of the United States while in military service and received the Air Force good conduct medal.



SD 134-

His occupational speciality was armament systems helper and weather observer. A complete background was furnished in connection with this record review and the entire record has been preserved in San Diego file 137-1643.

VI. DRAFT STATUS

Inasmuch as informant has served honorably in the U. S. Military Service for a period of four years he is under no current obligation for reserve training and does not participate in any reserve activity at the present time.

VII. DOMESTIC STATUS

Informant is married to CINDY L. GODREY and they are the parents of one child born during the summer of 1968. Informant is known to be a happily married man and has demonstrated his concern for his family in the past and is believed to have a satisfactory domestic and marital status.

VIII. CONSIDERATION FOR USE IN ESPIONAGE AND FOREIGN NATIONALITY CASES

No attempt has been made at this point to encourage or evaluate the participation of informant in espionage or foreign nationality cases, however, it is considered to be very possible for informant to be developed in this area if such a need should develop.

The following information is set out in connection with section 107 (N) of the manual of instructions beginning with item #2 of sub 3.

II. RESIDENCE AND EMPLOYMENT

Informant presently resides with his wife at 4582 Maple Street, La Mesa, California. He has previously been employed by the Pacific Telephone and Telegraph Company at 9th and C Streets, San Diego, California, however, he recently terminated this employment and commenced employment with the San Diego Fire Department, August 23, 1968, seeking an increase in pay in order to be able to support his family.

III. CURRENT MEMBERSHIP AND POSITION HELD IN SUBVERSIVE ORGANIZATIONS

Informant is not a current member of any subversive organization but does attend and participate in activities of several groups, which includes the San Diego White Citizen Council, The Peace and Freedom Party, and is extremely active in the activities of the Minutemen in the San Diego, California area.

IV. SUMMARY OF INFORMATION FURNISHED

Since February of 1967 informant has been in close contact with several individual involved in the direction of the Minutemen Group in the San Diego area. He is well acquainted with TROY HAUGHTON, former West Coast leader of the Minutemen and continues to the present time to be in frequent contact with Mrs. BETTY HAUGHTON, since the disappearance of TROY HAUGHTON several months ago. He continues to obtain and to make available to the San Diego Division all publications and printed material distributed by the local Minutemen Organization. Informant is currently one of the three men engaged in the leadership of the Local Total Resistance Organization in the San Diego area, set up as an alliance to work with the Minutemen. Informant has worked with Mr. WILLIAM CLAY and others with the Local Total Resistance Organization. This three man committee is divided in the control of the Organization. Informant is the number 2 man in the group who has been assigned the responsibility for development of intelligence material and the maintaining of records for all activities. Informant is presently under consideration by WILLIAM CLAY as one of the members of the group who might be assigned to travel to the East Coast and attempt to assist in the coordination of activities of such groups as The Loyal Order of Mountanmen and other similar groups in an effort to help direct the activities of all similar groups in coordinating their efforts on a nationwide basis. More specific items are not being enumerated at this point, inasmuch as this information has been previously furnished to the Bureau in Bufile 137-17222.

V. AMOUNT PAID FOR SERVICES AND EXPENSES

From March of 1967 to July 31, 1968, informant has been paid a total of \$400.00 for expenses and services rendered.

VI. TYPE AND NUMBER OF MEETINGS ATTENDED AND OTHER ACTIVITY

Informant attends numerous activities of a varied nature including participation in Minutemen activities, planning and council meetings of the Minutemen, as well as, fullfills assignments to work at the headquarters of the Peace and Freedom Party, the American Nazi Party, San Diego Council for Social Action, and the Patriotic Party, where he attempts to obtain information and records of those groups for use by the Minutemen. In addition to meetings attended the informant makes numerous visits to the homes of people participating in Minutemen and other activities including the residents of TROY HAUGHTON, where he attempts to keep track of the activities of Mrs. BETTY HAUGHTON during the absence of her husband, former regional director of the West Coast Minutemen activities.

VII. NUMBER OF WRITTEN AND ORAL STATEMENTS SUBMITTED

Informant has been submitting primarily oral information with the exception of printed bulletins and other material which he obtains from various mailing rooms of organizations he visits, as well as obtaining names, addresses and membership lists of individuals participating in various group activities.

VIII. INFORMATION FURNISHED OF UNUSUAL VALUE

Through his close association with the HAUGHTON family informant has maintained a relationship which has enabled him to keep the San Diego Division apprised of the activities of BETTY HAUGHTON since the disappearance of her husband TROY HAUGHTON several months ago. Informant has also been furnishing information relative to the obtaining and stock piling weapons and ammunition by numerous individuals in the San Diego area.

IX. APPROXIMATE NUMBER OF PERSONS ON WHOM INFORMANT FURNISHED COVERAGE AND THEIR IMPORTANCE

Through informants background and wide knowledge of firearms and explosives he is closely acquainted with practically all individuals in the San Diego area who deal in weapons and ammunition. This includes approximately 25 individuals who not only buy and sell weapons and ammunition in the San Diego area but who also travel to Los Angeles and Yuma, Arizona, where they purchase weapons and bring them to the San Diego area for resale. Inasmuch as

SD 134-

informant is closely associated with these individuals he is able to furnish specific information regarding numerous purchases and the sales by such people. In addition to these individuals informant also acquainted with approximately 20 people actively engaged in Minutemen and related type groups in the San Diego area. Informant also knows by sight numerous individuals who attend such activities as those sponsored by the Patriotic Party, the Peace and Freedom Party and the San Diego County White Citizen Council Meetings.

X. STEPS BEING TAKEN TO ADVANCE INFORMANT

Informant has been encouraged to continue his progress in the Local Minutemen Organization to the extent that he is closely associated with WILLIAM CLAY, who is one of the apparent leaders of the Minutemen activity in the Southern California area. Through his association with CLAY the informant has been able to furnish considerable information relative to plans and programs of the Minutemen in the San Diego area. Informant will continue his association with BETTY HAUGHTON and others who are apparently in positions of leadership in the Minutemen activities in the San Diego area.

XI. STABILITY AND RELIABILITY

Since the initial development of the informant there have been no situations occur which have caused any embarrassment to the Bureau nor has there been any situation occur which would cause any question relative to the emotional stability of the informant. With regard to his domestic situation he is believed to be a happily married man and with the exception of the recent critical condition of a newborn child has had no extreme personal difficulties. In connection with the birth of his child the informant reported that immediately the child's birth in July of 1968, doctors felt that heart surgery would be necessary and that a cathORIZATION would have to be performed. The surgery was subsequently performed and after three weeks in the hospital the child was allowed to be taken home and at the present time is reported by the informant to be in a very satisfactory condition.

XII. INDOCTRINATION AGAINST DISCLOSURE

SD 134-

Informant is cautioned at each contact that he must maintain strict security in connection with the information which he furnishes to the FBI. It is to be noted that the informant is extremely cautious with regard to his association with the Bureau, inasmuch as he realizes that there is considerable personal danger should any disclosure arise relative to his activities in connection with the meetings he attends and his relationship with those people involved in extreme right wing activities. Contacts with the informant are made at irregular times and in varied locations so there is very little likelihood that detection made of informants contact with the FBI.

XIII. ALL NECESSARY ACTION TAKEN ON INFORMATION FURNISHED

The Bureau and all appropriate offices have been properly advised of information which has been furnished in the past by the informant relative to matters of Bureau interest. Items of a local nature furnished by the informant have been disseminated to local police agencies involving information of value to local agencies.

XIV. MISCELLANEOUS

Due to extensive training and interest on the part of the informant he is extremely well qualified with regard to identification and use of all types of weapons and ammunition including newest types of explosives. His background in this area has been of particular interest in qualifying him for assisting the Minutemen and other groups in developing technical data regarding explosives and arms and ammunitions.

UACB the San Diego Division will continue to contact this informant and consider him to be a security informant and information furnished by him will be handled on that basis. Any criminal information which is furnished by the informant will continue to be accepted and will be appropriately disseminated.

DIRECTOR, FBI

11-13-68

SAC, SAN DIEGO (134- ) (P)

HOWARD BARRY GODFREY  
~~██████████~~

Informant was designated a criminal informant of the San Diego Division on August 10, 1967. He was furnishing primarily criminal information at the beginning of his development, however, he has continued to direct his efforts toward infiltrating the activities of the Minutemen in the San Diego area. SD 1155-8 is the only informant in the San Diego area who is able to furnish any information regarding Minutemen activities up to the present time. Due to the Bureau's continuing interest in the Minutemen activities informant has been encouraged to devote his full time to this activity and it is therefore felt appropriate he should be designated a security informant at this time.

I recommend that authority be granted to make payments to the above informant up to \$75.00 per month for services plus up to \$25.00 per month for expenses actually incurred for a period of six months effective December 1, 1968.

Background information regarding informant has been set out in San Diego letter to the Bureau dated 8-10-67, (Bufile 137-17222), however, appropriate information is being repeated at this time for background purposes.

I. CHECK OF FIELD OFFICE FILES

A review of the indices of the San Diego Office fail to reflect any derogatory information regarding informant.

II. CANVAS OF LOGICAL INFORMANTS

A discrete canvas of all logical informants in the San Diego Division in the Security Field has been made and there is no indication that any of these informants are personally acquainted with the informant. It is to be noted that subject devotes the majority of his time to Minutemen activities and does not participate in activities of the Communist Party or other subversive groups.

- (3 - Bureau
- (1 - 137-17222)
- 3 - San Diego
- (1 - 134-1643)

CAN:blb

(6)

NOT RECORDED

87 NOV 15 1968

COMMUNICATIONS SECTION

ORIGINAL FILED IN

### III. PERSONAL HISTORY

Informant is a white male, born 7-1-43, at Portsmouth, England, presently residing at 4582 Maple Street, La Mesa, California. He is presently undergoing training as a firemen with the San Diego Fire Department and has previously been employed at the Pacific Telephone and Telegraph Company, San Diego, California. A review of his employment record at the Telephone Company was made on 5-10-67, at which time it was determined that the employment record contained no derogatory information. Informant has been furnishing information of value to the San Diego Division for approximately 1 1/2 years during which time he has demonstrated himself to be a reliable stable individual, who enjoys a favorable reputation and is believed to be a loyal American citizen with high moral standards and high degree of personal integrity. During his operation as a criminal informant he has demonstrated his ability to develop information in a very discrete manner and has never caused any embarrassment to the Bureau.

### IV. CREDIT AND CRIMINAL RECORDS

A review of local credit and arrest records in the San Diego Division has been made and there is no information of a derogatory nature regarding subject's credit history and no arrest record was located. Form FD 165 has previously been submitted to the Identification Division effective 8-1-67.

### V. ARMED SERVICES RECORD

The master service file of HOWARD BARRY GODREY, serial number AF19724309, was reviewed on 9-12-67, at the Records Service Division, Air Reserve Personnel Center, Denver, Colorado. The file reflects informant born 7-1-43, at Portsmouth, England. He enlisted on 1-18-62, at Phoenix, Arizona, in the grade of Airmen Basic for Service in the U. S. Air Force for a period of four years. He went on extended active duty on 1-18-62. He was separated from the service in the grade of Airmen Second Class on 1-17-66, after being honorably released from active duty upon completion of his enlistment. He received performance ratings ranging from good to excellent and was recommended for an Air Force career. He did not serve outside the continental limits of the United States while in military service and received the Air Force good conduct medal.

SD 134-

His occupational speciality was armament systems helper and weather observer. A complete background was furnished in connection with this record review and the entire record has been preserved in San Diego file 137-1643.

#### VI. DRAFT STATUS

Inasmuch as informant has served honorably in the U. S. Military Service for a period of four years he is under no current obligation for reserve training and does not participate in any reserve activity at the present time.

#### VII. DOMESTIC STATUS

Informant is married to CINDY L. GODREY and they are the parents of one child born during the summer of 1968. Informant is known to be a happily married man and has demonstrated his concern for his family in the past and is believed to have a satisfactory domestic and marital status.

#### VIII. CONSIDERATION FOR USE IN ESPIONAGE AND FOREIGN NATIONALITY CASES

No attempt has been made at this point to encourage or evaluate the participation of informant in espionage or foreign nationality cases, however, it is considered to be very possible for informant to be developed in this area if such a need should develop.

The following information is set out in connection with section 107 (N) of the Manual of Instructions beginning with item #2 of sub 3.

#### II. RESIDENCE AND EMPLOYMENT

Informant presently resides with his wife at 4582 Maple Street, La Mesa, California. He has previously been employed by the Pacific Telephone and Telegraph Company at 9th and C Streets, San Diego, California, however, he recently terminated this employment and commenced employment with the San Diego Fire Department, August 23, 1968, seeking an increase in pay in order to be able to support his family.



III. CURRENT MEMBERSHIP AND POSITION HELD IN SUBVERSIVE ORGANIZATIONS

Informant is not a current member of any subversive organization but does attend and participate in activities of several groups, which includes the San Diego White Citizen Council, The Peace and Freedom Party, and is extremely active in the activities of the Minutemen in the San Diego, California area.

IV. SUMMARY OF INFORMATION FURNISHED

Since February of 1967 informant has been in close contact with several individual involved in the direction of the Minutemen Group in the San Diego area. He is well acquainted with TROY HAUGHTON, former West Coast leader of the Minutemen and continues to the present time to be in frequent contact with Mrs. BETTY HAUGHTON, since the disappearance of TROY HAUGHTON several months ago. He continues to obtain and to make available to the San Diego Division all publications and printed material distributed by the local Minutemen Organization. Informant is currently one of the three men engaged in the leadership of the Local Total Resistance Organization in the San Diego area, set up as an alliance to work with the Minutemen. Informant has worked with Mr. WILLIAM CLAY and others with the Local Total Resistance Organization. This three man committee is divided in the control of the Organization. Informant is the number 2 man in the group who has been assigned the responsibility for development of intelligence material and the maintaining of records for all activities. Informant is presently under consideration by WILLIAM CLAY as one of the members of the group who might be assigned to travel to the East Coast and attempt to assist in the coordination of activities of such groups as The Loyal Order of Mountanmen and other similar groups in an effort to help direct the activities of all similar groups in coordinating their efforts on a nationwide basis. More specific items are not being enumerated at this point, inasmuch as this information has been previously furnished to the Bureau in Bufile 137-17222.

V. AMOUNT PAID FOR SERVICES AND EXPENSES

From March of 1967 to July 31, 1968, informant has been paid a total of \$400.00 for expenses and services rendered.

VI. TYPE AND NUMBER OF MEETINGS ATTENDED AND OTHER ACTIVITY

Informant attends numerous activities of a varied nature including participation in Minutemen activities, planning and council meetings of the Minutemen, as well as, fulfills assignments to work at the headquarters of the Peace and Freedom Party, the American Nazi Party, San Diego Council for Social Action, and the Patriotic Party, where he attempts to obtain information and records of these groups for use by the Minutemen. In addition to meetings attended the informant makes numerous visits to the homes of people participating in Minutemen and other activities including the residence of TROY HAUGHTON, where he attempts to keep track of the activities of Mrs. BETTY HAUGHTON during the absence of her husband, former regional director of the West Coast Minutemen activities.

VII. NUMBER OF WRITTEN AND ORAL STATEMENTS SUBMITTED

Informant has been submitting primarily oral information with the exception of printed bulletins and other material which he obtains from various mailing rooms of organizations he visits, as well as obtaining names, addresses and membership lists of individuals participating in various group activities.

VIII. INFORMATION FURNISHED OF UNUSUAL VALUE

Through his close association with the HAUGHTON family informant has maintained a relationship which has enabled him to keep the San Diego Division apprised of the activities of BETTY HAUGHTON since the disappearance of her husband TROY HAUGHTON several months ago. Informant has also been furnishing information relative to the obtaining and stock piling weapons and ammunition by numerous individuals in the San Diego area.

IX. APPROXIMATE NUMBER OF PERSONS ON WHOM INFORMANT FURNISHED COVERAGE AND THEIR IMPORTANCE

Through informants background and wide knowledge of firearms and explosives he is closely acquainted with practically all individuals in the San Diego area who deal in weapons and ammunition. This includes approximately 25 individuals who not only buy and sell weapons and ammunition in the San Diego area but who also travel to Los Angeles and Yuma, Arizona, where they purchase weapons and bring them to the San Diego area for resale. Inasmuch as

informant is closely associated with these individuals he is able to furnish specific information regarding numerous purchases and the sales by such people. In addition to these individuals informant also acquainted with approximately 20 people actively engaged in Minutemen and related type groups in the San Diego area. Informant also knows by sight numerous individuals who attend such activities as those sponsored by the Patriotic Party, the Peace and Freedom Party and the San Diego County White Citizen Council Meetings.

X. STEPS BEING TAKEN TO ADVANCE INFORMANT

Informant has been encouraged to continue his progress in the Local Minutemen Organization to the extent that he is closely associated with WILLIAM CLAY, who is one of the apparent leaders of the Minutemen activity in the Southern California area. Through his association with CLAY the informant has been able to furnish considerable information relative to plans and programs of the Minutemen in the San Diego area. Informant will continue his association with BETTY HAUGHTON and others who are apparently in positions of leadership in the Minutemen activities in the San Diego area.

XI. STABILITY AND RELIABILITY

Since the initial development of the informant there have been no situations occur which have caused any embarrassment to the Bureau nor has there been any situation occur which would cause any question relative to the emotional stability of the informant. With regard to his domestic situation he is believed to be a happily married man and with the exception of the recent critical condition of a newborn child has had no extreme personal difficulties. In connection with the birth of his child the informant reported that immediately the child's birth in July of 1968, doctors felt that heart surgery would be necessary and that a cathORIZATION would have to be performed. The surgery was subsequently performed and after three weeks in the hospital the child was allowed to be taken home and at the present time is reported by the informant to be in a very satisfactory condition.

XII. INDOCTRINATION AGAINST DISCLOSURE

SD 134-

Informant is cautioned at each contact that he must maintain strict security in connection with the information which he furnishes to the FBI. It is to be noted that the informant is extremely cautious with regard to his association with the Bureau, inasmuch as he realizes that there is considerable personal danger should any disclosure arise relative to his activities in connection with the meetings he attends and his relationship with those people involved in extreme right wing activities. Contacts with the informant are made at irregular times and in varied locations so there is very little likelihood that detection made of informant's contact with the FBI.

XIII. ALL NECESSARY ACTION TAKEN ON INFORMATION FURNISHED

The Bureau and all appropriate offices have been properly advised of information which has been furnished in the past by the informant relative to matters of Bureau interest. Items of a local nature furnished by the informant have been disseminated to local police agencies involving information of value to local agencies.

XIV. MISCELLANEOUS

Due to extensive training and interest on the part of the informant he is extremely well qualified with regard to identification and use of all types of weapons and ammunition including newest types of explosives. His background in this area has been of particular interest in qualifying him for assisting the Minutemen and other groups in developing technical data regarding explosives and arms and ammunitions.

UACB the San Diego Division will continue to contact this informant and consider him to be a security informant and information furnished by him will be handled on that basis. Any criminal information which is furnished by the informant will continue to be accepted and will be appropriately disseminated.

UNITED STATES GOVERNMENT

# Memorandum

*File*

TO : SAC, San Diego (Your file \_\_\_\_\_) DATE: 11/25/68

FROM : Director, FBI (Bufile and Serial 137-17222)  
Room No. \_\_\_\_\_

Post in file and destroy 0-1 (For SOG use only)

SUBJECT : \_\_\_\_\_  
\_\_\_\_\_  
\_\_\_\_\_

- 1. Bufiles indicate this case is delinquent. Give specific reason for delinquency.
- Letter submitted 11/13/68 recommending informant be designated as security informant.*

- airtel       letterhead memo       submitted.
- 2. DATE  report       letter       90-day progress letter       will be submitted \_\_\_\_\_

Reporting employee \_\_\_\_\_

- 3. If valid reason exists for not submitting report at this time, state reason specifically and when report will be submitted \_\_\_\_\_

- 4. Status of  Appeal       Inquiry       Investigation
- airtel       letterhead memo
- 5. Submit  report       letter       90-day progress letter

SEARCHED _____	INDEXED _____
SERIALIZED _____	FILED _____
NOV 27 1968	
FBI - SAN DIEGO	

by CT

(Place reply hereon and return to Bureau. Note receipt and acknowledgment on top serial in case file.)

7149

*File 9 abn*

UNITED STATES GOVERNMENT

# Memorandum

TO : DIRECTOR, FBI (137-17222)

DATE: 3/21/69 *CM/P*

FROM : SAC, SAN DIEGO (134-914)

*P/14*  
SUBJECT: ~~CONF. INFT.~~

*Reg. 7.2  
view  
Suff.*

Re San Diego letter to the Bureau dated 11/13/68  
and Bureau letter to San Diego dated 12/6/68.

The Bureau is advised that captioned informant  
is using the code name JEROME in furnishing written reports  
to the Bureau.

- ② - Bureau
- 2 - San Diego

SLC:mtg  
(4)

*see under*

REC-21  
MCT-40

137-17222-4

10 MAR 26 1969

*[INT. SEC.]*

*159*  
54 APR 4 - 1969

1 - Mr. C. D. Brennan (SF)  
1 - Mr. J.F. Farr

S/C, San Diego (134-914)

7/2/69

SR

REC-132  
Director, FBI (137-17222)-5

~~██████████~~  
EX-103

Bureau 6/10/69.

Authority is granted to increase payments to captioned informant from \$75 per month up to \$100 per month for services rendered and to continue payment of expenses at the same rate of up to \$50 per month for expenses actually incurred for six months effective 6/1/69.

Concerning your payments to this informant, you are reminded that payments must be commensurate with the value of information received and that payments for expenses are to be made only for those actually incurred. The informant should clearly understand that he is not being paid on a salary basis.

Advise Agent and stenographic personnel of your office in letters such as referenced letter only the first page of the carbon copy of these letters should be typed and transmitted to the Bureau. To type more than this is inefficient and a waste of time and is not in accordance with existing instructions. You should also advise Agent personnel that payment justification letters should be submitted two weeks prior to the date when the authorization is due.

1 - Mr. M.P. Row (6221 IB)

JFF:slg

(6)

NGEE: *[Signature]*

7-1-69

~~██████████~~, 25 years old, and a honorable discharged U.S. Air Force veteran, has been undergoing training as a fireman with the San Diego, California, Fire Department. He was designated a criminal informant of the San Diego Office in August, 1967, however, information furnished by him since his development primarily concerns Minutemen activities in the San Diego area. He is the primary source of such activities in the area, and has furnished information regarding plans of the organization and background of its leaders and members. He has also provided coverage of New Left activities. He is in contact with members and officers of the Minutemen several times weekly, has attended meetings of a gun club and the American Volunteer Club, both of which are patronized by the Minutemen. He has been at a number of New Left rallies and demonstrations. He has submitted 15 written and 19 ~~██████████~~ in payments is warranted.

Olson \_\_\_\_\_  
DeLoach \_\_\_\_\_  
Mohr \_\_\_\_\_  
Bishop \_\_\_\_\_  
Casper \_\_\_\_\_  
Callahan \_\_\_\_\_  
Conrad \_\_\_\_\_  
Felt \_\_\_\_\_  
Gale \_\_\_\_\_  
Rosen \_\_\_\_\_  
Sullivan \_\_\_\_\_  
Tavel \_\_\_\_\_  
Trotter \_\_\_\_\_  
Tele. Room \_\_\_\_\_  
Holmes \_\_\_\_\_  
Gandy \_\_\_\_\_

MAILED 24  
JUL - 2 1969  
COMM-FBI

UNITED STATES GOVERNMENT

# Memorandum

TO : DIRECTOR, FBI (137-17222)

DATE: 6/16/69

FROM : SAC, SAN DIEGO (134-914) (P)

SUBJECT: ~~CONFIDENTIAL~~  
SI

Re San Diego letter to the Bureau 3/21/69, approving up to \$75 per month for services and up to \$25 per month for expenses incurred on a C.O.D. basis from 12/1/68 to 6/1/69.

I. RECOMMENDATION

*Increase \$25*

It is recommended that increased authority be granted to pay the above SI up to \$100 per month for services rendered and up to \$25 ~~per~~ *Sum* per month for expenses actually incurred for a period of six months, effective 6/1/69. An additional \$25 monthly is requested for services due to expected increased activity of the Minutemen organization in the San Diego area and informant's increased importance in the organization.

II. RESIDENCE AND EMPLOYMENT

SI resides at 738 Graves, El Cajon, California, and is employed full time by the San Diego City Fire Department.

III. CURRENT MEMBERSHIP IN SUBVERSIVE ORGANIZATIONS

Informant is considered a member of the local Minutemen organization.

IV. SUMMARY OF INFORMATION FURNISHED DURING PERTINENT PERIOD

During the period 12/1/68 to 6/1/69, informant has continuously participated in Minutemen activities in the San Diego area. He has furnished information on the plans of this organization and background information on its leaders and members. Informant has also provided coverage of several New Left activities by attending or participating anonymously. This informant is not the only source of information concerning the Minutemen organization in the San Diego area. However, he is the primary source of such information.

AMOUNT PAID FOR SERVICES AND EXPENSES

*137-17222-5*

*JFF: sfg 7/2/69*

Date	Services	Expenses
12/12/68	\$35.00	\$15.00
1/17/69	40.00	(10.00)
2/13/69	35.00	15.00
3/12/69	37.00	13.00

REC 36

INT. SEC.

2 - Bureau (RM)  
2 - San Diego  
SLC: pgh/mt (4)



## V. AMOUNT PAID FOR SERVICES AND EXPENSES, continued

<u>Date</u>	<u>Services</u>	<u>Expenses</u>
3/28/69	\$36.00	\$12.00 ✓
4/18/69	29.00	11.00
5/7/69	37.50	12.50

VI. TYPE AND NUMBER OF MEETINGS  
ATTENDED AND OTHER ACTIVITIES

While the local Minutemen organization holds no regular meetings, the informant is in contact several times weekly with leaders and members of the group. In addition, he has attended meetings of a gun club and also of the American Volunteer Group, both of which are patronized by Minutemen. He has also been present at several New Left rallies and demonstrations.

VII. NUMBER OF WRITTEN AND  
ORAL REPORTS SUBMITTED

Written - 15 reports  
Oral - 19 reports

VIII. INFORMATION FURNISHED OF UNUSUAL VALUE

Informant has been the primary source of information relating to the Minutemen organization and the activities of its members in the San Diego area. He has provided advance information on the plans of the Minutemen organization and also the activities of several New Left and black militant organizations, in San Diego.

IX. APPROXIMATE NUMBER OF PERSONS  
ON WHOM INFORMANT HAS FURNISHED COVERAGE AND THEIR  
IMPORTANCE

SI is currently furnishing information on ten or fifteen individuals who are active in the Minutemen organization, in addition to a number of individuals who are sympathetic to the organization. Informant has also furnished information on speakers and organizers of local New Left organizations.

X. STEPS BEING TAKEN TO ADVANCE THE INFORMANT

Informant has gravitated to a position of trust and confidence with the recognized leaders of the local Minutemen organization. At the present time, SI is probably the third or

SD 134-914 .

fourth most prominent member of the organization. He has been instructed to avail himself of every opportunity to enhance his position in the organization.

XI. STABILITY AND RELIABILITY

Informant has exhibited no indications of personal weakness, untrustworthiness, unreliability or other problems and steps are being taken to guard against future situations which may possibly embarrass the Bureau.

XII. INDOCTRINATION AGAINST DISCLOSURE

Informant has been properly indoctrinated against making any disclosure in any manner of his relationship with the Bureau. He has been operating as a symbol number informant for the San Diego Division since August, 1967.

XIII. ALL NECESSARY ACTION TAKEN  
ON INFORMATION FURNISHED

All necessary action has been taken in information furnished by the informant.

UNITED STATES GOVERNMENT

# Memorandum

*Handwritten initials*

TO : DIRECTOR, FBI (137-17222) DATE: 11/17/69

FROM : SAC, SAN DIEGO (134-914)

CONF. INFO.

SUBJECT: SI SECURITY

*Handwritten initials*

RE: ~~RACIAL~~ INFORMANT PROGRESS/JUSTIFICATION LETTER

I.  (a) I recommend that authority be granted to continue captioned informant for a period of \_\_\_\_\_ months and that he continue to be paid under the authority of the Special Agent in Charge, UACB.

(b) I recommend that authority be granted to pay captioned informant an amount up to \$ 100 per  month  week for services rendered on a c.o.d. basis, and up to \$ 25 per  month  week for expenses actually incurred for a period of six  months  weeks effective 12/1/69.  
*(If increase, furnish full justification under "Miscellaneous.")*

*Handwritten initials*

II. Membership: Informant is a member of the Minutemen Organization in the San Diego area.

Amount paid for services and expenses:

Date	Services	Expenses
6/11/69	\$70.00	9.60
8/5/69	65.00	16.43
10/10/69	45.00	12.49
11/10/69	95.00	21.50

Number of activities and persons on whom coverage is provided: Informant reports regularly on activities of 30 - 40 members of the Minutemen Organization and related right wing organizations at San Diego, California. In addition informant is acquainted with approximately five persons connected with the publishing of the "San Diego Free Door to Liberation", a San Diego underground newspaper and reports on activities connected to it. Due to free time available to the informant by the nature of his employment, he is able to observe and report on activities of radical and militant individuals and organizations, both on and off college campuses in the San Diego area.

Number of statements (written and oral) submitted: 24

Considered stable and reliable  Yes  No (Explain in "Miscellaneous.")

Indoctrinated against disclosure  Yes

Percentage of information verified 95%

All necessary action taken on information furnished  Yes  No (Explain in "Miscellaneous.")

137-17222-6

NOV 20 1969

REC-47

MAILED 23  
DEC 2 - 1969  
COMM-FBI

3 Bureau (AM-RM)

San Diego

APPROVED

Date

DEC 2 1969

Summary of information furnished: *(If more space needed, add addendum.)* On 9/7/69, informant reported WILLIAM CLAY, local leader of the Minutemen Organization, allegedly has in his possession a large quantity of Composition C high explosive.

On 9/8/69, informant advised that LYLE MANNING, local right wing sympathizer and owner of a gun store and swap shop, is allegedly buying and selling stolen military equipment and is sending weapons to Servicemen in Vietnam.

On 9/12/69, informant reported WILLIAM CLAY will become more active in Minutemen activities and in order to protect his family, has moved into an apartment in El Cajon, California, to make it appear he has separated from his wife.

On 9/16/69, informant advised of the formation of the new right wing organization known as Virtue In America. This organization was established by PAUL RUPLINGER, a Minutemen member and friend of WILLIAM CLAY. Informant provided the names of 22 persons believed to be members of or interested in this organization.

(See attached Addendum, page 2a)

Miscellaneous: *(Furnish any change in residence and employment, steps being taken to advance informant, and any other pertinent information which should be brought to Bureau's attention.)*

The informant is being encouraged to take advantage of any opportunities to enhance his position in the Minutemen Organization and in other right wing groups. He is also being encouraged to penetrate left wing activities and to gain the confidence of individuals involved therein wherever possible.

Informant has been instructed to report all compensation received from the Bureau for services as income when filing an income tax return and he has agreed to comply.

ADDENDUM

SUMMARY OF INFORMATION FURNISHED: (Continued)

During the period 10/8 - 15/69, informant provided coverage of "Stop the War Week" sponsored by the Student Mobilization Committee at San Diego State College. Coverage included photographs taken by the informant which allowed the identification of several previously unknown militant leaders at San Diego State College. One of these was HARRY RUJA, San Diego State College professor who on 10/15/69 admitted to informant he had solicited donations for the Viet Cong.

During this same period of time, informant provided coverage of right wing harassment activities on the San Diego State College campus including the placing of Minutemen stickers, painting out the names of San Diego area Vietnam war dead on a signboard prepared by the Student Mobilization Committee, and the hanging in effigy of ANGELA DAVIS, self-admitted Communist and Black Panther Party member.

On 10/3/69, informant reported on activities of LEON NOWER, Professor at San Diego State College, including his involvement in the Exploring Family School, a school organized by San Diego area radical individuals and designed to teach revolutionary thoughts and ideas to elementary age school children.

On 10/28/69, informant advised the "San Diego Free Door to Liberation", a San Diego underground newspaper, had moved to a new address and was planning a small protest demonstration on the occasion of the National Convention of the Sigma Delta Chi Fraternity, a society of journalists at San Diego, California, on 11/13/69.

During the period 10/15/69 - 11/14/69, informant has provided information relating to preparations by militant individuals at San Diego, California, for the DEMNOV Demonstrations on 11/15/69 and right wing plans to harass those activities occurring in San Diego area on that date.

SAC, San Diego (170-236)

6-18-70

EX-115

Director, FBI (157-17222) — 7

1-Mr. J. G. Deegan  
1-Mr. R. L. Ridgeway

REC-128

Reurlet 6-8-70.

In view of informant's membership in the Minutemen organization and the nature of information he furnishes, he is being designated a racial informant and should be carried as such in the future.

Pursuant to your recommendation, authority granted to make payments to captioned informant at a level of up to \$350 per month for services and up to \$100 per month for expenses, for a period of six months, effective 6-1-70. This payment authorization represents an increase to previous payment levels of up to \$150 for services and up to \$75 per month for expenses. Be certain all payments to this informant are commensurate with the value of information received and actual expenses incurred on a c.o.d. basis.

It has been noted in the past that you have been making payments to this informant in even amounts of \$100 for services. You should refrain from making payments in the exact amount each time in order to avoid having informant reach the erroneous conclusion that he is being paid on a salary basis. Therefore, in the future, stagger amounts of payments to this informant.

1-Mr. M. F. Row 6221, IB

RLR:djw  
(6)

NOTE:

Informant is a 26-year-old white male employed as a fireman in San Diego, California. He was designated a criminal informant in August, 1967, and converted to a security informant in December, 1968. Since 1968, he has furnished

- Tolson \_\_\_\_\_
- DeLoach \_\_\_\_\_
- Walters \_\_\_\_\_
- Mohr \_\_\_\_\_
- Bishop \_\_\_\_\_
- Casper \_\_\_\_\_
- Callahan \_\_\_\_\_
- Conrad \_\_\_\_\_
- Felt \_\_\_\_\_
- Gale \_\_\_\_\_
- Rosen \_\_\_\_\_
- Sullivan \_\_\_\_\_
- Tavel \_\_\_\_\_
- Soyars \_\_\_\_\_
- Tele. Room \_\_\_\_\_
- James \_\_\_\_\_
- Sandy \_\_\_\_\_

NOTE CONTINUED PAGE TWO

Letter to San Diego  
RE: SD 1155-R  
137-17222

NOTE CONTINUED:

information on the Minutemen and related groups in the San Diego area. He has also furnished reports on meetings, demonstrations, and other activities of the Student Mobilization Committee, and the San Diego Citizens Mobilization Committee; advanced information concerning the eviction of the militant New Left underground newspaper, "The San Diego Street Journal." He has also furnished information concerning conferences of Students for a Democratic Society and advanced information of militant students' plans to seize a part of the Administration Building, San Diego State College. He is not contacted on campus and not affiliated with an educational institution. During pertinent period, he furnished 87 reports of which 95 percent of information verified through other sources. Current payment levels are \$100 per month for services and \$25 per month for expenses. An increase in payments as authorized above fully justified, based on a value of information furnished and informant potential. This has been coordinated with the Security Informant Unit.

UNITED STATES GOVERNMENT

# Memorandum

TO : DIRECTOR, FBI (137-17222) DATE: 6/3/70

FROM : *E.A.C.G.*  
SAC, SAN DIEGO (170-286) (P)

*J.F. Moore*

SUBJECT: CONF. INFO.  
SI

Re: RACIAL OR SECURITY INFORMANT PROGRESS/JUSTIFICATION LETTER

I.  (a) I recommend that authority be granted to continue captioned informant for a period of \_\_\_\_\_ months effective \_\_\_\_\_ and that he continue to be paid under the authority of the Special Agent in Charge, UACB.

(b) I recommend that authority be granted to pay captioned informant an amount up to \$ 250 per  month  week for services rendered on a c.o.d. basis, and up to \$ 100 per  month  week for expenses actually incurred for a period of six  months  weeks effective 6/1/70.  
*(If increase, furnish full justification under "Miscellaneous.")*  
*inc cost \$75*

II. Membership: Informant is a member of the Minutemen Group in the San Diego area.

Amount paid for services and expenses:

Date	Period Covered	Services	Expenses
12/15/69	11/1 - 30/69	\$100	\$19.36
1/16/70	12/1 - 31/69	\$100	\$22.43

(See attached Addendum, page 2a)

Number of activities and persons on whom coverage is provided:

Informant reports regularly on activities of 30 to 40 individuals associated with the Minutemen organization and related right wing organizations in San Diego, California. He continues to be employed by the San Diego City Fire Department and consequently has considerable free time available to use in observing and reporting on activities of a number of radical and militant individuals and organizations both on and off college campuses in the San Diego area. Informant has attended and reported on planning meetings, demonstrations, and other activities of such organizations as the San Diego Citizens Mobilization Committee (CMC) and Student Mobilization Committee (SMC) to end the war in Vietnam and the Movement for a Democratic

Number of statements (written and oral) submitted: 87 137-17222-7

Considered stable and reliable  Yes  No (Explain in "Miscellaneous.")

Indoctrinated against disclosure  Yes

Percentage of information verified 95%

All necessary action taken on information furnished  Yes  No (Explain in "Miscellaneous.")

3 - Bureau  
1 - San Diego  
SLC:kdw (4)

JUN 3 1970

RACIAL SEC.



Summary of information furnished: *(If more space needed, add addendum.)*

On 11/17/69, 3/5/70, 3/11/70, 3/20/70 and 3/21/70, informant furnished an extremely large volume of information consisting mostly of names and addresses of persons supporting or sympathetic to New Left oriented activities in and around San Diego which were obtained through harrassment activities of right wing groups and individuals in the San Diego area.

On 12/8/69, informant provided advance information regarding the eviction of the San Diego Street Journal, a militant New Left oriented underground newspaper from its offices at 360 Fifth Avenue, San Diego, California, because of general disturbances and harrassment activities directed against the Street Journal and the landlord.

On 1/8/70, informant reported that WILLIAM CLAY, San Diego area leader of the Minutemen Organization, had traveled during the last two weeks of December, 1969, throughout several western states for the purpose of making contact with Minutemen and right wing groups and individuals to establish some kind of communications and contact network. Informant advised CLAY was extremely pleased with the results of his trip.

*(See attached Addendum page 2a)*

Miscellaneous: *(Furnish any change in residence and employment, steps being taken to advance informant, and any other pertinent information which should be brought to Bureau's attention.)*

Informant has been instructed to report all compensation received from the Bureau for services as income when filing an income tax return and he has agreed to comply.

It is noted an increase in the amount of money to be authorized for payment of services and expenses to the informant is requested. Informant has provided large volumes of information concerning activities of both right and left wing individuals and organizations in the San Diego area and regularly contacts the San Diego Office several times weekly. It is felt the time and effort given on the part of the informant in providing this coverage to the Bureau is worth well in excess of the amount previously authorized. In addition, informant has stated that with additional expense money available, he would be able to provide greater in depth coverage of activities of Minutemen and other right wing extremist individuals, especially with regard to the sales and movements of weapons, ammunition and explosives.

Informant continues to be encouraged to take advantage of any opportunities to improve his coverage of activities of interest to the Bureau in the San Diego area.

AMOUNT PAID FOR SERVICES AND EXPENSES (Continued):

<u>Date</u>	<u>Period Covered</u>	<u>Services</u>	<u>Expenses</u>
3/3/70	1/1 - 31/70	\$100	\$16.29
3/30/70	2/1 - 28/70	\$100	\$24.33
4/24/70	3/1 - 31/70	\$100	\$21.93
6/2/70	4/1 - 30/70	\$100	\$14.13
6/2/70	5/1 - 31/70	\$100	\$12.00

NUMBER OF ACTIVITIES AND PERSONS ON WHOM COVERAGE IS PROVIDED (Continued):

Military (MDM). Informant has traveled to Oceanside, California, to cover activities of MDM there.

SUMMARY OF INFORMATION FURNISHED: (Continued)

On 1/8/70, informant reported that through contact with the publisher of the San Diego Free Door to Liberation, a local underground newspaper he had learned the paper is losing money and that the publisher had found it necessary to use money from his savings and from other funds to continue printing the paper.

On 1/20/70, informant provided advance information regarding a conference of the Students for a Democratic Society, which was to be held at Los Angeles, California, during the period 1/24 - 25/70. Subsequently, informant provided information regarding the conference itself. ✓

On 3/12/70, informant provided advance information on the seizure of part of the Administration Building at San Diego State College by students protesting administration action regarding four professors and lecturers popular with the many militant and radical students at the school. Informant continued to provide coverage of the progress of the demonstration until its conclusion on 3/17/70. ||

On 3/23/70, informant reported on the establishment of contact between the San Diego Minutemen Group and a

Minutemen cell or organization at Santa Ana, California, which was previously unknown to the San Diego group. Informant stated plans were made for mutual cooperation on activities of the two groups.

Prior to 4/15/70, informant attended several planning meetings of the CMC and the SMC and was able to provide advance information on the anti-Vietnam war demonstration which took place in San Diego on 4/15/70. During this demonstration, informant provided photographic coverage and was helpful in establishing the presence of a number of known militants at the demonstration.

Informant has also provided coverage of anti-war rallies and demonstrations sponsored by the MDM at San Diego on 4/18/70 and at Oceanside, California, on 5/10/70; anti-war rallies at San Diego sponsored by CMC and SMC on 5/9/70; a teach-in and rally at San Diego State College on 5/18/70 sponsored by Tuesday the Ninth Committee, a militant organization at that school opposed to white racism and political oppression.

On 5/1/70, informant made a pretext visit to an individual named MORRIS KOMINSKI at Elsinore, California. Informant described KOMINSKI as a person who formerly moved in high levels of federal and local government and said he learned KOMINSKI is soon to have published a book in two volumes and in excess of 2,000 pages on the history of facism in the United States. Informant also learned KOMINSKI is sympathetic to the San Diego Street Journal and its publishers and has provided that paper with large quantities of information regarding political and business activities, as well known individuals in the San Diego area, some of which information has appeared in subsequent issues of the paper.

// In addition to the foregoing, informant has provided large quantities of information regarding activities of right wing individuals and Minutemen members in the San Diego area.

*[Handwritten signature]*

SAC, San Diego (170-286)

12/8/70

Director, FBI ( 137-17222 )

Attention: Voucher-Statistical Section

1 - Mr. R. L. Ridgeway

REC-54  
EX-106

Reurlet dated 11/27/70.

Authority is granted to designate captioned individual a Bureau-approved PSI and to proceed to develop source as a security informant in accordance with instructions set forth in Section 107, Volume IV, Manual of Instructions.

Authority is granted to designate captioned individual as a  probationary racial informant  ghetto probationary racial informant in accordance with instructions set out in Section 130, Volume IV, Manual of Instructions.

Authority is granted to pay captioned informant an amount up to \$ 250 per  month  week for services rendered, on a c.o.d. basis, and up to \$ 100 per  month  week for expenses actually incurred for a period of 6  months  weeks effective 12/1/70. You should continue to maintain contact with informant and follow appropriate instructions in the Manual of Instructions.

Advise captioned informant that the Bureau is not concerned with the legitimate activities of the college or university or of its students. Do not contact informant on the campus.

SEARCHED 12  
SERIALIZED 12/10/70  
INDEXED  
FILED

Bufiles disclose no pertinent information regarding  captioned source  immediate relatives of source

Concerning your payments to this informant and all informants, you are reminded that payments must be commensurate with the value of the information received; that payments are to be made only for actual expenses incurred in connection with obtaining information for the FBI. In addition, payments should be made in such a manner that the informant clearly understands he is not being paid on a salary basis but rather on a c.o.d. basis.

Make certain informant understands cooperation with Bureau is strictly voluntary and that this cooperation must be maintained on a confidential basis at all times. Impress upon informant that informant is not Bureau employee. Exercise caution in your contacts with informant to make certain informant is not a plant.

- Tolson \_\_\_\_\_
- Sullivan \_\_\_\_\_
- Mohr \_\_\_\_\_
- Bishop \_\_\_\_\_
- Brennan \_\_\_\_\_
- Callahan \_\_\_\_\_
- Casper \_\_\_\_\_
- Conrad \_\_\_\_\_
- Felt \_\_\_\_\_
- Gale \_\_\_\_\_
- Rosen \_\_\_\_\_
- Tavel \_\_\_\_\_
- Walter \_\_\_\_\_
- Soyars \_\_\_\_\_
- Tele. Room \_\_\_\_\_

RLR:rmm (4).

SEE NOTE PAGE TWO

DEC 16 1970 363

*[Handwritten signatures and initials: CMA, W.S., R.L., etc.]*

Letter to SAC, San Diego  
RE: SD 1155-R  
137-17222

NOTE:

The above is a continuation of previously authorized payment levels. Informant is a member of the Minutemen in San Diego on which he furnishes information. In addition, he furnishes reports on the activities of the Student Mobilization Committee and the San Diego Citizens Mobilization Committee. During the past payment period he submitted 95 reports which included coverage on 30 to 40 Minutemen followers and related right wing oriented individuals. Ninety-five percent of the information furnished was verified through other sources. During past payment period informant attended meetings and demonstrations of several antiwar and new left oriented extremist groups including travel to Los Angeles to cover the Disneyland invasion by the Youth International Party. Informant is the sole source of information on Minutemen activities in the San Diego area.

UNITED STATES GOVERNMENT

# Memorandum

TO : DIRECTOR, FBI(137-17222) DATE: 11/27/70

FROM : SAC, SAN DIEGO (170-286) (P)

CONF. INFO.

SUBJECT:

Re: RACIAL OR SECURITY INFORMANT PROGRESS/JUSTIFICATION LETTER

- I.  (a) I recommend that authority be granted to continue captioned informant for a period of \_\_\_\_\_ months effective \_\_\_\_\_ and that he continue to be paid under the authority of the Special Agent in Charge, UACB. *same*
- (b) I recommend that authority be granted to pay captioned informant an amount up to \$ 250 per  month  week for services rendered on a c.o.d. basis, and up to \$ 100 per  month  week for expenses actually incurred for a period of six  months  weeks effective 12/1/70.  
(If increase, furnish full justification under "Miscellaneous.")

II. Membership: Informant is a member of the Minutemen (MM) Organization in San Diego, California.

Amount paid for services and expenses:

(See page 1-A)

Number of activities and persons on whom coverage is provided:

Informant reports regularly on activities of 30 to 40 individuals associated with the MM organization and related right wing groups in the San Diego, California, area. He continues to be employed by the San Diego City Fire Department which employment affords him considerable free time which he can use to observe and report on activities of many radical and militant individuals and organizations on and off college campuses in the San Diego area. Informant has attended planning meetings and demonstrations of various anti-war and militant groups and voluntarily traveled to Los Angeles, California, to observe an attempted invasion of Disneyland by individuals supporting the Youth International Party (yippies).

Number of statements (written and oral) submitted: 94 *137-17222-10*

Considered stable and reliable  Yes  No (Explain in "Miscellaneous.")

Indoctrinated against disclosure  Yes

Percentage of information verified 95% *EX-106*

All necessary action taken on information furnished  Yes  No (Explain in "Miscellaneous.")

- 2 - Bureau (RM)
- 1 - San Diego SLC:jam (3)

*987.00*  
*10.50*

*12-8-71 11:41 AM*

*3*  
*137-17222-10*

*REC-94*

SD 170-286

<u>Period</u>	<u>Services</u>	<u>Expenses</u>
6/1 - 6/30/70	\$200	\$39.47
7/1 - 7/31/70	210	36.70
8/1 - 8/31/70	215	29.44
9/1 - 9/30/70	230	26.39

Summary of information furnished: *(If more space needed, add addendum.)*

On 5/6/70, informant was in attendance at a rally of the Peace and Freedom Party (PFP) on the University of California at San Diego (UCSD) campus and, while there, obtained a number of copies, with names and addresses, of a PFP petition which was being circulated. The purpose of the petition was to impeach RONALD REAGAN, Governor of California. On 5/8/70, informant reported on plans being made by the San Diego Citizens Mobilization Committee (CMC) and the Student Mobilization Committee (SMC) at San Diego State College (SDSC) to protest the announcement of the United States' invasion of Cambodia.

On 5/9/70, informant was present at and observed the anti-war march and rally sponsored by CMC and SMC and furnished the names of a number of individuals responsible for, and participating in, the rally. Source also furnished photographic coverage of individuals participating in the rally and reported on attempts by an small number of right wing oriented individuals to disrupt the march.

(Cont'd on Page 3)

Miscellaneous: *(Furnish any change in residence and employment, steps being taken to advance informant, and any other pertinent information which should be brought to Bureau's attention.)*

Informant has been instructed to report on compensation received from the Bureau for services as income when filing his income tax return and he has agreed to comply.

Informant continues to be encouraged to take advantage of any opportunities to improve his coverage of activities of interest to the Bureau in the San Diego area. Due to the somewhat disorganized nature of the MM organization and related groups in the San Diego area because of the fugitive status and arrest of ROBERT BOLIVAR DE PUGH, National MM Leader, informant has been able to assume a position of leadership among many right wing oriented individuals in this area.



SD 170-286

On 5/27/70, source reported on the establishment of a new information center on the UCSD campus. The purpose of the new information center was to be a message, telephone, and contact center for student members of the radical or New Left community at the school.

On 6/3, and 6/8/70, source was instrumental in identifying GEORGE HOOVER as the person who had been actively and militantly associated with the MM organization in the San Diego area and was able to furnish information regarding HOOVER's associates and his place of residence.

On 7/2/70, source provided the names and addresses of three individuals who had contacted San Diego area underground newspaper for information regarding Weatherman activities and the establishment of a Weatherman group in San Diego. These names and addresses were obtained by members of the MM organization and made available to the source.

On 8/6/70, source traveled to Los Angeles, California, to observe an attempted invasion of the Disneyland Amusement Park by persons who had previously advertised themselves as being Yippies of the Youth International Party.

On 8/17/70, source was present at the White Whale, a restaurant and tavern in the San Diego area which caters to members of the New Left movement and the hippie establishment, and reported on activities there in connection with a fund raising benefit for the San Diego Street Journal, a San Diego area underground newspaper. Source reported that a large number of individuals were present and it appeared that a considerable amount of money had been raised.

On 9/2/70, informant reported information he had obtained indicating that plans were being made by individuals in the San Diego area for a large scale anti-Vietnam war demonstration to take place on 9/3/70 during the visit and State dinner of President NIXON and President ORDAZ of Mexico at Coronado, California.

On 9/3/70, source was present at activities and festivities surrounding the visit of Presidents NIXON and ORDAZ at Coronado, California, and furnished information regarding individuals he recognized as being militant members

SD 170-286

of the New Left movement and who were observed to have firearms in their vehicles.

On 8/27/70, source was in contact with former General WILLIAM LENLY of Coronado, California, who furnished source with extensive information regarding an organization known as American Volunteer Group (AVG) which LENLY described as being an underground military organization, the purpose of which is to take over the United States Government in the event it appears to be threatened either from within or without by Communists or other totalitarian organizations or governments.

During the months of September and October, 1970, source successfully penetrated Message Information Center (MIC), a message and telephone service established by members of the New Left movement in San Diego for the benefit of persons adhering to the New Left policy. Source was able to furnish a large volume of information concerning individuals connected with the MIC.

Informant is sole source of information in the MM activities in the San Diego area.

1 - Mr. L. L. Anderson

SAC, La Hogo (170-286)  
Director, FBI (137-17222 -) 9

6/10/71

Attention: Voucher-Statistical Section

*[Handwritten signature and initials]*

FBI - MEMPHIS

Authority is granted to designate captioned individual a Bureau-approved PSI and to proceed to develop source as a security informant in accordance with instructions set forth in Section 107, Volume IV, Manual of Instructions.

Authority is granted to designate captioned individual as a  probationary racial informant  ghetto probationary racial informant in accordance with instructions set out in Section 130, Volume IV, Manual of Instructions.

Authority is granted to pay captioned informant an amount up to \$ 250.00 per  month  week for services rendered on a c.o.d. basis, and up to \$ 100.00 per  month  week for expenses actually incurred for a period of ~~6-12~~  months  weeks effective 6/1/71. You should continue to maintain contact with informant and follow appropriate instructions in the Manual of Instructions.

MAILED 2  
JUN 10 1971  
FBI

Advise captioned informant that the Bureau is not concerned with the legitimate activities of the college or university or of its students. Do not contact informant on the campus.

Bufiles disclose no pertinent information regarding  captioned source  immediate relatives of source

Concerning your payments to this informant and all informants, you are reminded that payments must be commensurate with the value of the information received; that payments are to be made only for actual expenses incurred in connection with obtaining information for the FBI. In addition, payments should be made in such a manner that the informant clearly understands he is not being paid on a salary basis but rather on a c.o.d. basis.

Make certain informant understands cooperation with Bureau is strictly voluntary and that this cooperation must be maintained on a confidential basis at all times. Impress upon informant that informant is not Bureau employee. Exercise caution in your contacts with informant to make certain informant is not a plant.

In the future, insure that Progress Letter is submitted at least two weeks before expiration date.

LJA:co  
(4)

SEE NOTE PAGE TWO

*[Handwritten notes and signatures]*

*[Handwritten notes and signatures]*

- Olson \_\_\_\_\_
- Hagan \_\_\_\_\_
- Harbo \_\_\_\_\_
- Shop \_\_\_\_\_
- Conrad, C.D. \_\_\_\_\_
- Callahan \_\_\_\_\_
- Isper \_\_\_\_\_
- Marad \_\_\_\_\_
- Thayer \_\_\_\_\_
- St \_\_\_\_\_
- De \_\_\_\_\_
- Wason \_\_\_\_\_
- Wel \_\_\_\_\_
- Alters \_\_\_\_\_
- Warr \_\_\_\_\_
- Tele. Room \_\_\_\_\_
- Blues \_\_\_\_\_

Letter to San Diego  
Re: SD 1155-R  
137-17222

NOTE:

The above is continuation of previously authorized payment levels. Informant is member of Minutemen organization in San Diego, California, and is principle informant reporting on this and other right wing groups in San Diego area. He has also furnished considerable information concerning New Left activity and antilaw enforcement demonstrations. Specifically, he has furnished information regarding Post Office boxes being opened under fictitious names, advance data regarding publishing of New Left underground newspapers identities of individuals organizing and participating in "Stop the Pig" rally, identified newly appointed National White People's Party (NSWPP) official in San Diego area and information regarding surveillance of FBI radio facilities at Ramona, California, as well as selected Minutemen sabotage targets. He has furnished 83 reports involving 30-40 individuals, 95% of which have been verified.

UNITED STATES GOVERNMENT

# Memorandum

TO : DIRECTOR, FBI (137-17222) DATE: 6/4/71

FROM : SAC, SAN DIEGO (170 285) (P)

SUBJECT: CONF. INFO [REDACTED]

Re: RACIAL OR SECURITY INFORMANT PROGRESS/JUSTIFICATION LETTER

- I.  (a) I recommend that authority be granted to continue captioned informant for a period of \_\_\_\_\_ months effective \_\_\_\_\_ and that he continue to be paid under the authority of the Special Agent in Charge, UACB.
- (b) I recommend that authority be granted to pay captioned informant an amount up to \$ 250 per  month  week for services rendered on a c.o.d. basis, and up to \$ 100 per  month  week for expenses actually incurred for a period of six  months  weeks effective 6/1/71.  
(If increase, furnish full justification under "Miscellaneous.")

II. Membership: Informant is a member of the Minutemen (MM) Organization in San Diego, California.

Amount paid for services and expenses: \_\_\_\_\_  
(See page 1-A)

Number of activities and persons on whom coverage is provided:

Informant reports regularly on activities of 30 to 40 individuals associated with the MM Organization and related right wing groups in the San Diego, California area. He continues to be employed by the San Diego City Fire Department which employment affords him considerable free time which he can use to observe and report on activities of many radical and militant individuals and organizations on and off college campuses in the San Diego area.

*See memo 5/10/71  
LLA:CD*

*Three copies received  
What is required in report 6/9/71*

*5-17 SD 6/8/71  
re: omission of  
Character. JWS/YS*

ST-110

REC-31 157-17222-9

62 JUN 5 1971

Number of statements (written and oral) submitted: 83

Considered stable and reliable  Yes  No (Explain in "Miscellaneous.")

Indoctrinated against disclosure  Yes

Percentage of information verified 95%

All necessary action taken on information furnished  Yes  No (Explain in "Miscellaneous.")

- ② - Bureau (RM)
- 1 - San Diego
- SLC/lse

RACIAL INT. SEC.

SD 170-286

<u>Period</u>	<u>Services</u>	<u>Expenses</u>
10/1 - 10/31/70	\$205	\$31.61
11/1 - 11/30/70	210	51.49
12/1 - 12/31/70	225	23.97
1/1 - 1/31/71	235	34.24
2/1 - 2/28/71	230	47.51

- la -

Summary of information furnished: *(If more space needed, add addendum.)*

In September 1970, source advised of the opening of several Post Office boxes by the MM organization and furnished the number of the Post Office boxes and the fictitious names under which they were rented.

In September, source also provided advance information on efforts to republish the new left underground newspaper named Street Journal and also on plans on the part of persons associated with the Street Journal to hold an anti-law enforcement demonstration named "Stop the Pig."

During October 1970, source provided coverage of the "Stop the Pig" rally, furnishing information regarding activities and identities of speakers and participants.. Furthermore, source provided similar information and coverage for an anti-war demonstration held in San Diego on 10/31/70.

(Cont-d on Page 3)

Miscellaneous: *(Furnish any change in residence and employment, steps being taken to advance informant, and any other pertinent information which should be brought to Bureau's attention.)*

Informant has been instructed to report on compensation received from the Bureau for services as income when filing his income tax return and he has agreed to comply.

Informant continues to be encouraged to take advantage of any opportunities to improve his coverage of activities of interest to the Bureau in the San Diego area. Due to the somewhat disorganized nature of the MM organization and related groups in the San Diego area because of the fugitive status and arrest of ROBERT BOLIVAR DE PUGH, National MM leader, informant has been able to assume a position of leadership among many right wing oriented individuals in this area.

During October 1970, source was instrumental in identifying MARGERY MC NICKLES as an associate of the MM organization and advised of her relationship with ROBERT BOLIVAR DE PUGH and with the Patriotic Party

In December 1970, source was instrumental in identifying GERALD L. SMITH as leader of the local National Socialist White People's Party.

In January 1971, source furnished information regarding surveillance of Bureau radio facilities at Ramona, California and MM plans to compile a list of selected targets for sabotage in the event of a totalitarian takeover of the United States. In addition, source furnished printed information regarding literature and other materials emanating from what was purported to be a new MM organization headquartered at Elgin, Illinois.

Source was provided information regarding possible efforts on the part of LOU CONDE, an MM affiliate to arm a seagoing vessel for the purpose of providing protection for American tuna boats against ships of various Latin-American countries while fishing in waters off those countries.

During February, March, April and May, source has provided information and coverage of several anti-war rallies on the San Diego State College campus and in the San Diego area. Furthermore, he has furnished information concerning continuing efforts on the part of right wing sympathizers in the Southern California area to rebuild the MM organization or to establish a new organization similar to the old one.

During the preceding six months, source has identified several individuals as being members or sympathizers of the MM organization and has provided extensive information regarding their activities including their dealings in firearms and explosives.

Informant is sole source of information in MM activities in the San Diego area.



FBI

Date: 7/27/71

Transmit the following in \_\_\_\_\_  
(Type in plaintext or code)

Via AIRTEL \_\_\_\_\_  
(Priority)

TO: DIRECTOR, FBI  
FROM: S.C. SAN DIEGO (170-236) (P)  
SUBJECT: ~~CONF INFL.~~  
RE - MINUTEMEN

*J.C.H.*

Re San Diego teletype to the Bureau dated 7/23/71 and Bureau teletype to San Diego dated 7/24/71.

Enclosed for the Bureau are the original and six copies of an LHM entitled "JERRY LYNN DAVIS, also known as Sam Davis; EUGENE BROWN," dated 7/27/71 at San Diego, San Diego file 174-428.

For the information of the Bureau, ~~\_\_\_\_\_~~ for reasons of his and his family's personal safety, has petitioned for relocation. Enclosed LHM sets forth in summary form the basis for his request. It appears from several years of association with the Minutemen organization and members and other individuals associated with this group, particularly JERRY LYNN DAVIS, the subject has a legitimate concern that injury or death may occur to him and his family as a result of his services performed in behalf of the government.

It is noted that the informant is willing to leave the home which he owns and a civil service job with the City of San Diego which pays him in excess of \$1,000 per month, in order to secure the safety of his family.

Informant has not asked for other employment and estimates that cost of relocation would amount to approximately \$1500 to \$2000.

- 1 - Bureau (Enc. 7) (RM)
- 2 - 137-10000
- 3 - San Diego (Enc. 3)
- 2 - 170-236
- 1 - 174-428

REC-2 137-17222-10

EX-104

16 JUL 29 1971

Approved: *[Signature]*  
Special Agent in Charge

Sent \_\_\_\_\_ M Per \_\_\_\_\_

*1-150 36946-1*  
*1-00*  
*1-100 by RS*  
*1-100 by [unclear]*  
*1-100 by [unclear]*  
*8/2/71*

UNREC COPY AND COPY OF ENCL FILED IN 174-2183

In accordance with the court decision set forth in S.C. Letter 70-12 dated 3/10/70, it would appear that the Government does have an obligation to relocate the informant. It would also appear that inasmuch as the informant's usefulness has been effectively terminated as the result of a case falling within the jurisdiction of the Alcohol, Tobacco and Firearms Division that either that agency or the U.S. Department of Justice should bear the expenses for such a relocation.

However, in the event neither ATFD nor the Department will accept the responsibility for providing such relocation to the informant, the FBI has a moral obligation to do so. This follows by virtue of the fact that ~~XXXXXX~~ was requested to serve as an informant by the Bureau and that he has performed faithfully in this capacity for four and one-half years.

The Bureau is requested to contact the Department of Justice and Washington, D.C. headquarters of ATFD to determine if they will provide necessary expenses to relocate the informant. If such a request is denied by these offices, it is then recommended that the Bureau take upon itself the government's obligation to relocate the informant at a place of safety to him and his family.



UNITED STATES DEPARTMENT OF JUSTICE

FEDERAL BUREAU OF INVESTIGATION

San Diego, California

July 27, 1971

In Reply, Please Refer to  
File No.

JERRY LYNN DAVIS,  
Also Known As Sam Davis;  
EUGENE BROWN

The following is information in addition to our communications dated June 29, 1971 and July 7, 1971.

For the past four and one-half years, the San Diego Division of the Federal Bureau of Investigation has been operating an informant who has been highly successful in penetrating the Minuteman organization in the San Diego, California, area. In this capacity, informant has performed an outstanding service to the government and to the nation in acquiring and making available a large volume of information regarding the activities of the Minuteman organization and related groups. In addition, due to the nature of his employment, informant has been successfully targeted against other unrelated activities and has provided coverage and penetration of a number of New Left oriented groups and demonstrations. The scope of information provided by the source has often extended beyond the immediate San Diego area to other parts of the nation. He also has been instrumental in identifying and following the activities of many individuals who are of interest to the Federal Bureau of Investigation. Informant has at all times been found to be stable, trustworthy and reliable.

The Minutemen is a paramilitant group organized in June, 1960, by ROBERT B. DE PUGH in Norborne, Missouri, as a resistance to the spread of communism in the United States by use of guerrilla tactics. DE PUGH is currently incarcerated in a Federal penitentiary for violation of the Federal Firearms Act.

On June 23, 1971, source advised that on the previous Saturday, June 19, 1971, he was in attendance at a gun show held at Pasadena, California. Accompanying him to the show

137-17222-10

ENCLOSURE

JERRY LYNN DAVIS, ALSO KNOWN AS  
SAM DAVIS; EUGENE BROWN

was JERRY LYNN DAVIS, known to the informant for several years as a member of the Minuteman organization. At the show, contact was made with a third party, EUGENE BROWN, a reporter for the "Anaheim Bulletin" and an associate of members of the Minuteman organization in the Los Angeles, California, area, if not a member himself.

During the show, several arrests were made, some by the Alcohol, Tobacco and Firearms Division (ATFD). Because of these arrests and long held attitudes on the part of DAVIS and BROWN that, although Communism and Socialism pose threats to their security, the government of this country is their real enemy, a decision was reached by BROWN and DAVIS that retaliation should be made against the government by bombing ATFD and the Internal Revenue Service (IRS) offices. Plans were made for the three to meet again the following Saturday evening at a motel in or near the City of El Cajon, California, the exact time and place not then specified. At this meeting, final plans would be made for the bombing and specific targets selected, one in the Los Angeles, California, area which BROWN would handle, and one at San Diego, California, which DAVIS would handle.

In apparent furtherance of this scheme, DAVIS delivered to the informant on two occasions, two metal ammunition cans for storage and safekeeping. These cans were found to contain several pounds of TNT explosives, 18 hand grenade fuse assemblies, two rifle grenades, approximately 275 blasting caps of various sizes and types, a military hand illuminating grenade, a number of parts for converting M-1 and M-15 rifles to the corresponding M-2 and M-16 fully automatic weapons and other miscellaneous items. This material was turned over to the Federal Bureau of Investigation by the informant on June 25, 1971, and was in turn given to ATFD for possible use as evidence by that agency.

Assistant U.S. Attorney STEPHEN G. NELSON, then Chief of the Complaint Section, U.S. Attorney's Office, San Diego, California, was contacted on June 25, 1971, and stated that, as then developed, the facts in this case did not represent a prosecutable violation and that additional

JERRY LYNN DAVIS, ALSO KNOWN AS  
SAM DAVIS; EUGENE BROWN

evidence, such as photographs and tape recordings substantiating the conspiratorial meeting to take place on the evening of June 26, 1971, would be necessary. For as yet unexplained reasons, subject BROWN did not appear for the meeting on the evening of June 26, 1971, and has not subsequently been seen or heard from by either the informant or subject DAVIS. Informant has advised that to his knowledge no additional plans have been made or work done toward carrying out the above-described bombings.

On July 20, 1971, subject DAVIS requested that the hand illuminating grenade included in the explosives given by him to the informant, be returned to him on the weekend of July 24 - 25, 1971, indicating he had some use for the weapon but not elaborating further on the matter.

On July 23, 1971, following consultation with Assistant U.S. Attorney ROBERT P. RISSO, newly appointed Chief of the Criminal Complaint Section, and with representatives of the San Diego ATFD office, authorization was granted by RISSO and by ATFD for the hand illuminating grenade to be returned to DAVIS through the informant. This was only to be done on the condition that the illuminating grenade was effectively deactivated.

At this same time, RISSO stated he saw no possible way to obtain successful prosecution of DAVIS in this matter. Furthermore, he advised that he would in no way authorize return of the remaining items of explosives to DAVIS.

On July 23, and 26, 1971, the source pointed out that DAVIS' request that the hand illuminating grenade be returned to him points up the fact that his request for other parts or all of the items entrusted by him to the informant is imminent. Because of his association with DAVIS, whom the informant believes to be bordering on being mentally irrational, informant is convinced that for whatever reason, when it becomes necessary for him to tell DAVIS he cannot return these materials to him it will become obvious to DAVIS that the informant is exactly that or has in some other way betrayed him, and that DAVIS will then take reprisal of a violent nature against the informant and his family.

JERRY LYNN DAVIS, ALSO KNOWN AS  
SAM DAVIS; EUGENIE BROWN

Inasmuch as the explosives cannot be returned, the informant has petitioned that he and his family be relocated in some other part of the country out of DAVIS' reach. To this end, informant is willing to leave his home and an excellent employment but does not ask for another job. Informant has stated a personal preference for relocation at Boise, Idaho, which he feels would be a safe location as it is not a place to which he would be expected to go.

On July 27, 1971, Special Investigator STEVE LOGAN, ATFD, San Diego, was contacted regarding the matter of relocating the informant. LOGAN stated that he was not in a position to make a determination on a question of that nature but stated he did not believe that ATFD would accept such a responsibility unless the informant had served as a witness in an ATFD prosecution.

This document contains neither recommendations nor conclusions of the FBI. It is the property of the FBI and is loaned to your agency; it and its contents are not to be distributed outside your agency.

FBI

Date: 8/2/71

Transmit the following in \_\_\_\_\_  
(Type in plaintext or code)

Via A I R T E L AIR MAIL - REGISTERED  
(Priority)

TO: DIRECTOR, FBI (137-17222)

FROM: SAC, SAN DIEGO (170-286) (P)

CONF. INFO.

RM-MINUTEMEN

Re San Diego airtel to the Bureau dated 7/27/71, with enclosed LHM entitled "JERRY LYNN DAVIS, aka.; EUGENE BROWN, BOMBING MATTER."

Enclosed for the Bureau are the original and six copies of a Letterhead Memorandum entitled "JERRY LYNN DAVIS; EUGENE BROWN," which is dated August 2, 1971, at San Diego, California, SD file 174-428.

Enclosed LHM sets forth details of a telephone call made by Mr. and Mrs. CHARLES GODFREY, 4433 Maple, La Mesa, California, on 7/28/71 to Field Supervisor ANTHONY J. MALONEY, JR. Also reflected in the LHM is the results of contact by SA STEVEN L. CHRISTENSEN with [redacted] on 7/29/71.

4 - Bureau (Encs. 7)(RM) EX-105  
(2 - 137-17222)  
(2 - 174-JERRY LYNN DAVIS, aka;  
EUGENE BROWN,  
BOMBING MATTER)

3 - San Diego  
(2 - 170-286)  
(1 - 174-428)

SLC/dfm/mt  
(7)

ENCLOSURE

REC-26/ 37-17222-11

Rec detached by  
Man Unit

AUG 6 1971

51 AUG 10 1971

Approved: \_\_\_\_\_  
Special Agent in Charge

Sent \_\_\_\_\_ M Per \_\_\_\_\_

UNREC COPY AND COPY OF ENCL FILED IN 174-2183

1-177-D  
1-170-286-1  
2-170-286-1  
8/11/71

Handwritten signatures and initials, including "D. J. Maloney" and "S. L. Christensen".

For the Bureau's information, it is noted that the parents of [REDACTED] have been aware of his activities in behalf of the Bureau, inasmuch as informant counselled with them at the time he was initially approached with regard to performing services for the FBI. Over the years, through casual contact, informant's parents have become fairly well acquainted with many of the individuals with whom the informant has associated in his capacity as a source of information, including JERRY LYNN DAVIS. Based on their knowledge of these individuals they have expressed considerable concern, not only for the safety of their son and his family, but also for other members of their own family.

No assurances with regard to relocation or securing employment for the informant have been made either to the informant or his parents.

With regard to the remark of the informant's father as to his "friends" in Washington, D.C., the inference of this remark was interpreted as being that if the FBI did not help SD 1155-R as to relocation, Mr. GODFREY might seek the assistance of his "friends" in Washington. This remark was not further pursued with Mr. GODFREY.





UNITED STATES DEPARTMENT OF JUSTICE  
FEDERAL BUREAU OF INVESTIGATION

San Diego, California  
August 2, 1971

In Reply, Please Refer to  
File No.

JERRY LYNN DAVIS;  
EUGENE BROWN

The following is information in addition to our communication dated July 27, 1971:

On July 26, 1971, the informant who has furnished the previous information in this case, was approached on the subject of relieving him of custody of certain explosive materials previously furnished to him by subject DAVIS, by the use of a search warrant for the explosives at his home. The search warrant, it was felt, would serve the purpose of explaining to DAVIS why this informant could not produce the explosives. After lengthy consideration, the informant declined to accept this suggestion as a workable solution to the problem. The informant is convinced that regardless of the reason given, when he advises DAVIS he no longer has possession of the explosives, DAVIS's anger will cause him to become irrational to the point that he would commit some act or acts of violence against the informant or his family. Informant continued to be of the opinion that due to the fact the explosives could not be made available for return to DAVIS, the only safe course of action for him and his family would be relocation in an area where the informant and his family would be out of DAVIS's reach.

On July 28, 1971, the informant's parents telephonically contacted the San Diego Division of the FBI. They advised that based on their knowledge of JERRY LYNN DAVIS, and other individuals with whom their son had been associating, they felt his concern for the personal safety of both himself and his family was completely justified. The parents advised that they contemplated moving to the state of Hawaii in the near future for reasons of health.

137-17222-11

JERRY LYNN DAVIS;  
EUGENE BROWN

In addition, the parents indicated they were not satisfied solely with the possibility of the informant's relocation to Boise, Idaho, and felt that in addition to relocation, the Federal Bureau of Investigation should secure a job for the informant at the place of relocation comparable to the \$12,000 a year job he presently holds at San Diego. The parents advised they had suggested to informant the possibility of his relocation in Hawaii, as they felt there should be an abundance of employment opportunities with the U.S. Government in that state and that the Federal Bureau of Investigation should be able to get one for their son without too much difficulty.

During this conversation, the informant's father advised he (the father) has friends in Washington, D.C., and that if it appeared help might be necessary in obtaining authorization for relocation and the securing of employment for the informant, he would be glad to contact these people for any assistance they might be able to render.

On July 29, 1971, the informant was recontacted at which time he stated he had continued to give the matter of relocation considerable thought. He pointed out that his parents have, for some time, been trying to convince him of the desirability of moving to the state of Hawaii. He explained that his parents have resided and visited in that state several times, and are contemplating moving there permanently in the near future for health and business reasons. Informant advised he personally continues to feel that relocation at Boise, Idaho, would be more advantageous to him. He stated he would appreciate assistance from the Federal Bureau of Investigation in finding employment there.

Informant further advised that the home in which he lives at San Diego is being purchased through a Federal Housing Administration (FHA) loan and has a current market value of approximately \$20,000. He said that subsequent to making the original estimate of \$1,500 to \$2,000, as the cost of relocating him to another place, the points required for liquidating FHA loans have raised from 2 to 10.

JERRY LYNN DAVIS;  
EUGENE BROWN

He said that this meant that while originally it would have cost him only \$400 to pay off his FHA loan, he is now faced with the problem of paying \$2,000 to do the same thing. The informant feels that it will now cost him approximately \$3,000 to \$3,500 to relocate at Boise, Idaho.

This document contains neither recommendations nor conclusions of the FBI. It is the property of the FBI and is loaned to your agency; it and its contents are not to be distributed outside your agency.

1 - Mr. F. A. Tansey

SAC, San Diego (1703225)

1/4/72

Director, FBI REC 25 ST 105 12  
137-17222

Attention: Voucher-Statistical Section

*Sawyer*  
*[Signature]*

Reurlet 12/23/71.

Authority is granted to designate captioned individual a Bureau-approved PSI and to proceed to develop source as a security informant in accordance with instructions set forth in Section 107, Volume IV, Manual of Instructions.

Authority is granted to designate captioned individual as a  probationary extremist informant  ghetto extremist informant in accordance with instructions set out in Section 130, Volume IV, Manual of Instructions.

Authority is granted to pay captioned informant an amount up to \$250.00 per  month  week for services rendered on a c.o.d. basis, and up to \$100.00 per  month  week for expenses actually incurred for a period of 6  months  weeks effective 12/1/71. You should continue to maintain contact with informant and follow appropriate instructions in the Manual of Instructions.

MAILED 23  
JAN 4 - 1972  
FBI

Advise captioned informant that the Bureau is not concerned with the legitimate activities of the college or university or of its students. Do not contact informant on the campus.

Bufiles disclose no pertinent information regarding  captioned source  immediate relatives of source

Concerning your payments to this informant and all informants, you are reminded that payments must be commensurate with the value of the information received; that payments are to be made only for actual expenses incurred in connection with obtaining information for the FBI. In addition, payments should be made in such a manner that the informant clearly understands he is not being paid on a salary basis but rather on a c.o.d. basis.

Make certain informant understands cooperation with Bureau is strictly voluntary and that this cooperation must be maintained on a confidential basis at all times. Impress upon informant that informant is not Bureau employee. Exercise caution in your contacts with informant to make certain informant is not a plant.

- Tolson \_\_\_\_\_
- Felt \_\_\_\_\_
- Rosen \_\_\_\_\_
- Mohr \_\_\_\_\_
- Bishop \_\_\_\_\_
- Miller, E.S. \_\_\_\_\_
- Callahan \_\_\_\_\_
- Casper \_\_\_\_\_
- Conrad \_\_\_\_\_
- Dalbey \_\_\_\_\_
- Cleveland \_\_\_\_\_
- Ponder \_\_\_\_\_
- Bates \_\_\_\_\_
- Tavel \_\_\_\_\_
- Walters \_\_\_\_\_
- Soyars \_\_\_\_\_
- Tele. Room \_\_\_\_\_
- Holmes \_\_\_\_\_
- Gandy \_\_\_\_\_

FAT:dls dls  
(4)

SEE NOTE PAGE TWO

*[Handwritten notes and signatures]*  
JED  
FBI  
DEM

Letter to San Diego  
Re: SD 1155-E  
137-17222

NOTE:

The above is continuation of previously authorized payment levels. Informant is member of Minutemen organization in San Diego, California, and is principal informant reporting on this and other right-wing groups in San Diego area. He has also furnished considerable information concerning New Left activity and anti-law enforcement demonstrations. Specifically he has provided information identifying approximately 15 individuals associated with known Minutemen or related right-wing supporters; data regarding alleged dealings in firearms and other items of interest on part of these individuals; coverage of a plot to bomb offices of the Alcohol, Tobacco, and Firearms Division in Southern California in retaliation for arrests made by that office during a gun show held at Pasadena, California, in June, 1971; information regarding leaders and members of the San Diego Branch of the National Socialist White People's Party (NSWPP); and, information concerning formation of a new group in San Diego known as the "Secret Army Organization." He has also identified several persons involved in New Left oriented activities in the San Diego area. Informant provided 76 reports involving 30-40 individuals, 95% of which has been verified. Requested payments fully justified.



SD 170-286

<u>PERIOD</u>	<u>SERVICES</u>	<u>EXPENSES</u>
6/1 - 30/71	\$240.00	\$51.25
7/1 - 30/71	\$250.00	\$96.00
8/1 - 31/71	\$205.00	\$30.12
9/1 - 30/71	\$205.00	\$25.55
10/1 - 29/71	\$210.00	\$21.40
11/1 - 30/71	\$220.00	\$27.50

- la -

Summary of information furnished: *(If more space needed, add addendum.)*

On several occasions during the period June, 1971 to November, 1971, informant has provided information containing pertinent details regarding the disappearance and probable death of TROY HAUGHTON, former West Coast leader of the MM Organization. In this regard, informant has been able to independently substantiate information received by other field divisions concerning HAUGHTON's probable death.

In addition, during the same period of time, informant has identified approximately 15 individuals, who are associated with known MM or related right wing supporters and sympathizers. He has furnished a large volume of information regarding alleged dealings in firearms and other items of interest on the part of these individuals.

In June, July, and August, 1971, informant provided considerable coverage of a plot on the part of JERRY LYNN DAVIS, a known MM leader in the San Diego area, and EUGENE BROWN, a right wing sympathizer in the Los Angeles, California area to bomb offices of the Alcohol, Tobacco, and Firearms Division in Southern California in retaliation for arrests made by that office during a gun show held at Pasadena, California in June, 1971.  
Miscellaneous: *(Furnish steps being taken to advance informant, and any other pertinent information which should be brought to Bureau's attention.)* (Cont'd Page 3)

Informant has been instructed to report on compensation received from the Bureau for services as income when filing his income tax return and he has agreed to comply.

Informant has been encouraged to take advantage of any opportunities to improve his coverage of activities of interest to the Bureau in the San Diego area. Through his close association with individuals involved in extremist activities in the San Diego area, he has been able to achieve a leadership position in these activities, particularly in the newly formed Secret Army Organization.



SD 170-286

During the period June to November, 1971, source has also provided information relative to the San Diego Branch of the National Socialist White People's Party, (NSWPP) identified some leaders and members of this group, and provided details regarding its relationships with similar groups at Los Angeles, California. Source has furnished the location of the new NSWPP Headquarters in the San Diego area. In October of 1971, source provided information regarding the formation of a new organization in San Diego known as the Secret Army Organization which was created by JERRY LYNN DAVIS and others to provide a new image for MM type activities in the area. Source has provided information regarding contact of leaders of this group with other individuals in the States of Arizona, Nevada, and Washington in an effort to expand the organization into those states.

During the months of October and November, 1971, the source was instrumental in identifying several individuals involved in New Left oriented activities in the San Diego area through surveillance and by participating in some of these activities.

Informant is sole source of information in MM and related activities in the San Diego area.

FEDERAL BUREAU OF INVESTIGATION  
COMMUNICATIONS SECTION

*[Handwritten signature]*

Mr. Felt	.....
Mr. Rosen	.....
Mr. Mohr	.....
Mr. Bishop	.....
Mr. Casper	.....
Mr. Callahan	.....
Mr. Conrad	.....
Mr. DeLoach	.....
Mr. Evans	.....
Mr. Gale	.....
Mr. Rosen	.....
Mr. Sullivan	.....
Mr. Tavel	.....
Mr. Trotter	.....
Mr. Tele. Room	.....
Miss Holmes	.....
Miss Gandy	.....

NR 16 SD CODE  
 947 PM NITEL 01-14-72 DDC  
 TO DIRECTOR 131-17222  
 FROM SAN DIEGO 170-236 2P

CONF. INFO.

~~REDACTED~~

EM - MM.

*[Handwritten signature]*

RE SD TEL TO BU JANUARY THIRTEEN LAST.

ON JANUARY THIRTEEN LAST, INFORMATION AS SET FORTH IN  
 RE TEL WAS FURNISHED ON A CONFIDENTIAL BASIS TO CAPTAIN KENNETH  
 O'BRIEN, SAN DIEGO PD, BY SA'S STEVEN L. CHRISTENSEN AND EARL  
 M. PETERSEN. INFORMANT'S IDENTITY WAS NOT DIVULGED DURING THE  
 INTERVIEW. O'BRIEN WAS ADVISED THAT THIS INFORMATION WAS  
 FURNISHED TO HIS DEPARTMENT FOR WHATEVER USE DEEMED APPROPRIATE.  
 O'BRIEN REPLIED HE WOULD MAKE SUCH DISSSEMINATION OF THIS INFORMATION  
 AS APPEARED NECESSARY. HE ASSURED INTERVIEWING AGENTS THAT  
 THIS INFORMATION WOULD BE MAINTAINED IN THE STRICTEST OF CONFIDENCE.  
 CAPTAIN O'BRIEN STATED THAT IN HIS PERSONAL OPINION,  
 FROM KNOWLEDGE HE THEN POSSESSED OF THE CASE INVOLVING THE

*[Handwritten initials]*  
 124  
 7

REC-32 131-17222-13

JAN 17 1972

END PAGE ONE

5- *[Handwritten signature]*  
 Haly *[Handwritten signature]*

F23



CODE

TELETYPE

NITEL

EX-104

FEDERAL BUREAU OF INVESTIGATION  
COMMUNICATIONS SECTION

1/14/72

TO SAC SAN DIEGO (170-286)  
FROM DIRECTOR FBI (154-17222)

JAN 14 1972

TELETYPE

- 1 - Mr. A. Rosen
- 1 - Mr. E.S. Miller
- 1 - Mr. Shackelford
- 1 - Mr. G.C. Moore
- 1 - Mr. L.G. Bradman
- 1 - Mr. J.G. Deegan
- 1 - Mr. R.L. Ridgeway

REURTEL JANUARY THIRTEEN, NINETEEN SEVENTYTWO.

CLOSELY FOLLOW SHOOTING INCIDENT SET FORTH IN REFERENCED  
TELETYPE AND PROMPTLY FURNISH BUREAU ALL PERTINENT DEVELOPMENTS.

FURNISH PERTINENT DETAILS TO THE SAN DIEGO POLICE DEPARTMENT; HOWEVER,  
WITHHOLD IDENTITY OF INFORMANT. THE IDENTITY OF INFORMANT SHOULD BE  
GIVEN ONLY AS A LAST RESORT AND THEN ONLY TO AN ESTABLISHED POLICE  
CONTACT WHO WILL HANDLE THE MATTER CONFIDENTIALLY.

REMINDE INFORMANT TO AVOID DIRECTLY BECOMING INVOLVED IN  
SITUATIONS THAT MIGHT DEVELOP INTO VIOLENT ACTIVITIES.

RLR:pjc <sup>v</sup>pc  
(9)

NOTE:

See memorandum G. C. Moore to Mr. E. S. Miller,  
dated 1/14/72, captioned ~~XXXXXXXXXX~~ "Extremist Informant,"  
prepared by RLR:pjc.

- Mr. Tolson \_\_\_\_\_
- Mr. Felt \_\_\_\_\_
- Mr. Rosen \_\_\_\_\_
- Mr. Mohr \_\_\_\_\_
- Mr. Bishop \_\_\_\_\_
- Mr. Miller, E.S. \_\_\_\_\_
- Mr. Callahan \_\_\_\_\_
- Mr. Casper \_\_\_\_\_
- Mr. Conrad \_\_\_\_\_
- Mr. Dalbey \_\_\_\_\_
- Mr. Cleveland \_\_\_\_\_
- Mr. Ponder \_\_\_\_\_
- Mr. Bates \_\_\_\_\_
- Mr. Wailart \_\_\_\_\_
- Mr. Walters \_\_\_\_\_
- Mr. Soyars \_\_\_\_\_
- Tele. Room \_\_\_\_\_
- Miss Holmes \_\_\_\_\_

GCM EM  
DEM JCP R

624

FEDERAL BUREAU OF INVESTIGATION  
COMMUNICATIONS SECTION

JAN 13 1972

NR 14 SD CODE  
710 PM NITEL 51-13-72 DDC  
TO DIRECTOR 134-17222  
FROM SAN DIEGO 170-286 6P

Mr. Tolson	_____
Mr. DeLoach	_____
Mr. Mohr	_____
Mr. Bishop	_____
Mr. Casper	_____
Mr. Callahan	_____
Mr. Conrad	_____
Mr. Felt	_____
Mr. Gale	_____
Mr. Rosen	_____
Mr. Sullivan	_____
Mr. Tavel	_____
Mr. Trotter	_____
Tele. Room	_____
Miss Holmes	_____
Miss Gandy	_____

G. R. [unclear]

CONF. INFO.

[REDACTED]

EM - MM.

1-14-72

1-14-72

RE SD TEL TO BU JANUARY SEVEN LAST, CAPTIONED CALREP; NEW LEFT MOVEMENT - VIOLENCE, IS - NL

REFERENCED TELETYPE REPORTED AN INCIDENT WHEREIN A YOUNG WOMAN, ALLEGEDLY A VISITOR AT FIVE ONE FIVE FIVE MUIR, SAN DIEGO, THE RESIDENCE OF PETER GEORGE BONMER (SD ONE ZERO ZERO DASH ONE FIVE FOUR FIVE ZERO), WAS THE VICTIM OF SHIPER FIRE RESULTING IN A GUNSHOT WOUND IN HER ELBOW. THE RESIDENCE AT FIVE ONE FIVE FIVE MUIR IS A WELL-KNOWN NEW LEFT COMMUNE NAMED "THE BOX" (SD ONE ZERO ZERO DASH ONE FIVE NINE SEVEN ONE). IT HAS BEEN DETERMINED THE GUNSHOT WOUND IS MINOR IN NATURE.

ON JANUARY TWELVE LAST CAPTIONED SOURCE WAS CONTACTED AT WHICH TIME HE FURNISHED THE FOLLOWING INFORMATION:

EX-104

137-17222-14

END PAGE ONE

RECEIVED  
FEDERAL BUREAU OF INVESTIGATION  
U.S. DEPARTMENT OF JUSTICE  
JAN 17 1972

5-16-72

PAGE TWO

ON DECEMBER TWENTY SEVENTYONE, THE SECRET ARMY ORGANIZATION (SAO) (SD ONE FIVE SEVEN DASH TWO EIGHT ONE FIVE), A NEWLY FORMED RIGHT WING PARAMILITARY ORGANIZATION IN THE SAN DIEGO AREA, PREPARED AND DISTRIBUTED A NUMBER OF COPIES OF AN INTELLEGIENCE TYPE BULLETIN REGARDING PETER GEORGE BOHMER. INFORMATION UTILIZED IN THE BULLETIN WAS OBTAINED PRIMARILY FROM RESEARCH OF NEWSPAPER ARTICLES AND PHYSICAL SURVEILLANCE OF THE BOHMER RESIDENCE BY SAO MEMBERS, INCLUDING INFORMANT. RESPONSE TO THE BULLETIN FROM RIGHT WING SYMPATHIZERS WAS CONSIDERED ENCOURAGING BY THE SAO AND <sup>C</sup>ONSEQUENTLY ON JANUARY SIX LAST INFORMANT WAS REQUESTED BY JERRY LYNN DAVIS (SD ONE ZERO ZERO DASH ONE FOUR TWO NINE SEVEN), LEADER OF THE SAO, TO CONDUCT ANOTHER SURVEILLANCE OF THE BOHMER RESIDENCE FOR THE PURPOSE OF OBTAINING ADDITIONAL INTELLEGIENCE INFORMATION SUCH AS LICENSE PLATE NUMBERS AND DESCRIPTIONS AND

END PAGE TWO

PAGE THREE

HABITS OF OCCUPANTS. ANY INFORMATION OBTAINED WAS TO BE USED IN THE PREPARATION OF FORTHCOMING SAO INTELLIGENCE BULLETINS.

INFORMANT, NOT DESIRING TO CONDUCT SUCH A SURVEILLANCE ALONG, CONTACTED (GEORGE M. HOOVER (SD ONE ZERO ZERO DASH ONE FIVE THREE FIVE SIX), AN ASSOCIATE OF SAO MEMBERS, REQUESTING HE ACCOMPANY SOURCE. SOURCE AND HOOVER ARRIVED IN THE VICINITY OF BOHMER'S RESIDENCE AT APPROXIMATELY EIGHT FORTYFIVE PM, JANUARY SIX LAST, WATCHED THE RESIDENCE FOR A PERIOD OF TIME, DETERMINED THERE WERE NO CARS PARKED ON THE STREET NEAR THE HOUSE, OBSERVED TWO INDIVIDUALS LEAVE THE HOUSE AND WALK AWAY TO AN UNKNOWN DESTINATION, AND FROM THE SUBSEQUENT APPEARANCE OF THE HOUSE ASSUMED IT THEN TO HAVE BEEN UNOCCUPIED. SOURCE AND HOOVER WENT SO FAR AS TO PLACE AN SAO STICKER ON THE FRONT DOOR OF THE RESIDENCE FOLLOWING WHICH THEY DROVE BY THE HOUSE ONE LAST TIME PRIOR

END PAGE THREE

PAGE FOUR

TO GOING HOME. AT THIS TIME, WITHOUT WARNING, HOOVER, WHO IS GENERALLY ARMED, POINTED A PISTOL OUT THE PASSENGER WINDOW OF THE CAR FIRING TWO SHOTS AT THE HOUSE. SOURCE YELLED AT HOOVER, "WHAT DO YOU THINK YOU'RE DOING?" AND THEN LEFT THE AREA AS QUICKLY AS POSSIBLE. SOURCE STATED THAT FORTUNATELY THE PISTOL, AN AUTOMATIC, JAMMED ON THE THIRD SHOT OR HE FEELS CERTAIN HOOVER WOULD HAVE EMPTIED THE CLIP IN THE GUN. SOURCE ADVISED HE UNDERSTANDS THAT THE WEAPON HAS BEEN DISPOSED OF.

IT IS NOTED SOURCE WAS DRIVING HIS SIXTYNINE RAMBLER AMERICAN, MEDIUM BLUE, GENERALLY MATCHING THE DESCRIPTION OF THE SHOOTING VEHICLE AS FURNISHED BY WITNESSES TO THE POLICE.

SOURCE EXPLAINED HE WAS RELUCTANT TO DISCUSS THIS MATTER IN DETAIL WHEN TELEPHONICALLY CONTACTED REGARDING THE SHOOTING ON JANUARY SEVEN LAST AS HIS WIFE WAS PRESENT AT THAT TIME AND HE DID NOT DESIRE TO UPSET HER UNNECESSARILY.

END PAGE FOUR



PAGE FIVE

HE STATED THAT THE ABOVE SHOOTING HAD COME AS A COMPLETE SURPRISE TO HIM AND THAT HE HAD NO INTENTION OR DESIRE TO TAKE ANY ACTION AT BOHMER'S RESIDENCE OTHER THAN TO OBTAIN WHATEVER INFORMATION WAS AVAILABLE AS DISCREETLY AS POSSIBLE. HE STATED HE IS EXTREMELY UPSET AND DISMAYED AT THIS TURN OF EVENTS.

IN CONNECTION WITH HIS ACTIVITIES IN BEHALF OF THE BUREAU, INFORMANT HAS BEEN REPEATEDLY CAUTIONED TO AVOID BECOMING DIRECTLY INVOLVED IN ANY SITUATION WHICH MIGHT CAUSE DEATH OR PERSONAL INJURY TO ANY PERSON. SOURCE HAS WHOLEHEARTEDLY AGREED WITH THIS POSITION AND HAS CONSISTANTLY FURNISHED ALL INFORMATION IN HIS POSSESSSION REGARDING THE POSSIBLE OCCURRENCE OF SUCH INSTANCES. IT IS BELIEVED SOURCE WAS TOTALLY UNAWARE THAT HOOVER MIGHT SHOOT INTO THE HOUSE PRIOR TO THE OCCURENCE OF THE INCIDENT AND HE HAS BEEN CAUTIONED TO AVOID ALL UNNECESSARY CONTACT WITH HOOVER IN THE FUTURE.

END PAGE FIVE

PAGE SIX

SOURCE STATED, TO HIS KNOWLEDGE, ONLY HE AND HOOVER ARE PRESENTLY AWARE OF THIS INCIDENT. SOURCE ADVISED THE INCIDENT APPEARS TO HAVE CAUSED HOOVER TO BECOME "FIRED UP" AND READY FOR A VIOLENT CONFRONTATION WITH THE POLICE IF APPROACHED ON THE MATTER. HE SAID HE DOUBTS HOOVER WOULD DISCUSS THE INCIDENT WITH ANYONE ELSE BUT CANNOT BE SURE OF THIS. IN VIEW OF HOOVER'S UNPREDICTABLE NATURE AND PRESENT EMOTIONAL STATE, SOURCE SAID HE WOULD ADVISE AGAINST ANY INTERVIEW OF HOOVER.

UACB, THE FOREGOING INFORMATION WILL BE DISCUSSED DISCREETLY WITH THE SAN DIEGO POLICE DEPARTMENT AND, IF NECESSARY, INFORMAT'S IDENTITY WILL BE FURNISHED TO THAT DEPARTMENT AT A LATER DATE.

END

UNITED STATES GOVERNMENT

# Memorandum

- Tolson \_\_\_\_\_
- Felt \_\_\_\_\_
- Rosen \_\_\_\_\_
- Moore \_\_\_\_\_
- DeLoach \_\_\_\_\_
- Mohr \_\_\_\_\_
- Malley \_\_\_\_\_
- Callahan \_\_\_\_\_
- Casper \_\_\_\_\_
- Conrad \_\_\_\_\_
- Dalbey \_\_\_\_\_
- Cleveland \_\_\_\_\_
- Ponder \_\_\_\_\_
- Bates \_\_\_\_\_
- Waikart \_\_\_\_\_
- Walters \_\_\_\_\_
- Soyars \_\_\_\_\_
- Tele. Room \_\_\_\_\_
- Holmes \_\_\_\_\_
- Gandy \_\_\_\_\_

TO : Mr. E. S. Miller *EM*

- 1 - Mr. A. Rosen
- 1 - Mr. E. S. Miller

DATE: 1/14/72

FROM : G. C. Moore *GCM*

- 1 - Mr. R. L. Shackelford
- 1 - Mr. G. C. Moore
- 1 - Mr. L. G. Brockman
- 1 - Mr. J. G. Deegan
- 1 - Mr. R. L. Ridgeway

CONF. INFO.

SUBJECT: ~~XXXXXXXXXX~~  
EXTREMIST INFORMANT

This is to advise of information developed by captioned informant disclosing a shooting incident arising from activities of the newly organized white extremist Secret Army Organization.

By memorandum dated 1/11/72, you were advised of the formation and activities of the newly formed ultraconservative white extremist paramilitary group known as Secret Army Organization (SAO). SAO has targeted for harassment San Diego State College Professor Peter Bohmer. Bohmer's residence is a well-known New Left commune, whose occupants, along with Bohmer, are planning demonstrations at the Republican National Convention scheduled at San Diego for August, 1972.

Captioned informant, a 28-year-old white male operated since August, 1967, has been recently targeted to penetrate the extremist-oriented SAO. On January 6, 1972, informant was requested by SAO leader to surveil Bohmer's residence in order to obtain intelligence information. Accompanying informant on surveillance was SAO associate George M. Hoover. The surveillance, held during the evening of January 6, 1972, was discontinued after the Bohmer residence appeared unoccupied. However, prior to discontinuance, an SAO sticker was left at the front door. While passing in front of the house in informant's automobile, Hoover, without warning and to the complete dismay of informant, fired two shots into the house. The informant strongly protested and they sped away. A female occupant of the house reportedly sustained minor gunshot wound in her elbow.

Enclosure

137-17222

RLR:pjc

(8)

JAN 27 1972 *OK*

137-17222-14X  
t. R. Ridgeway

REC-2

CONTINUED OVER

JAN 20 1972

Memorandum to Mr. E. S. Miller  
Re: SD 1155-E  
134-17222

Informant furnished details of the shooting, which would not have been available through any other source, and cautioned that Hoover is "fired up" over the incident and ready for a violent confrontation should police approach him on this matter. Identities of those involved in shooting not known to San Diego police; however, witnesses did furnish description of informant's automobile.

This informant, during his utilization, has furnished exceptionally valuable information on the Minutemen and has been completely reliable. He has been previously cautioned, as all extremist informants are, not to become directly involved in violent confrontations or activities. He is the only Bureau source covering the violence-prone SAO. San Diego has advised that pertinent information developed by informant will be furnished to the San Diego Police Department but informant's identity withheld unless disclosure becomes necessary. There appears to be no objection to this, and San Diego will be instructed to closely follow this matter and promptly report pertinent developments.

RECOMMENDATION:

That attached teletype in accordance with above be approved and sent.

*Detached  
+ sent 11/14  
WBS*

*[WIFE]*

*Per JGD  
DEM*

*OK R  
P/STP  
7*

*EM  
WBS  
AS*



TELETYPE TO SAN DIEGO  
RE: SD 1155-E  
134-17222

NOTE:

William Yakopec, El Cajon, California, has disclosed to captioned informant that he is responsible for bombing of Guild Movie Theater in San Diego and plans additional bombings. Informant is acquainted with Yakopec through involvement in Secret Army Organization (SAO), an extremist right-wing group in San Diego. Without informant's testimony, SDPD will not be able to obtain arrest warrant for Yakopec. Therefore, SDPD requests informant be made available as prosecution witness. Informant believed extremely reluctant to testify for fear of life and personal safety. SAC recommends informant be made available to SDPD provided he is willing to cooperate and PD can afford protection. Informant is member of SAO on behalf of Bureau. He is a 28-year-old white male operated since 1967.

1 - Mr. R. L. Ridgeway  
1 - Mr. F. A. Tansley

SAC, San Diego (173-285)

7/3/72

EX-112

Acting Director, FBI (157-17322)

Attention: Voucher-Statistical Section

16

Reurlet 6/20/72.

Authority is granted to designate captioned individual a Bureau-approved PSI and to proceed to develop source as a security informant in accordance with instructions set forth in Section 107, Volume IV, Manual of Instructions.

Authority is granted to designate captioned individual as a  probationary extremist informant  ghetto extremist informant in accordance with instructions set out in Section 130, Volume IV, Manual of Instructions.

Authority is granted to pay captioned informant an amount up to \$ 250 per  month  week for services rendered on a c.o.d. basis, and up to \$ 100 per  month  week for expenses actually incurred for a period of 6/5/72  months  weeks effective 6/5/72. You should continue to maintain contact with informant and follow appropriate instructions in the Manual of Instructions.

Advise captioned informant that the Bureau is not concerned with the legitimate activities of the college or university or of its students. Do not contact informant on the campus.

Bufiles disclose no pertinent information regarding  captioned source  immediate relatives of source

Concerning your payments to this informant and all informants, you are reminded that payments must be commensurate with the value of the information received; that payments are to be made only for actual expenses incurred in connection with obtaining information for the FBI. In addition, payments should be made in such a manner that the informant clearly understands he is not being paid on a salary basis but rather on a c.o.d. basis.

Make certain informant understands cooperation with Bureau is strictly voluntary and that this cooperation must be maintained on a confidential basis at all times. Impress upon informant that informant is not Bureau employee. Exercise caution in your contacts with informant to make certain informant is not a plant.

- Felt \_\_\_\_\_
- Campbell \_\_\_\_\_
- Rosen \_\_\_\_\_
- Mohr \_\_\_\_\_
- Bishop \_\_\_\_\_
- Miller, E.S. \_\_\_\_\_
- Callahan \_\_\_\_\_
- Casper \_\_\_\_\_
- Conrad \_\_\_\_\_
- Dalbey \_\_\_\_\_
- Cleveland \_\_\_\_\_
- Ponder \_\_\_\_\_
- Bates \_\_\_\_\_
- Waikart \_\_\_\_\_
- Walters \_\_\_\_\_
- Soyars \_\_\_\_\_
- Tele. Room \_\_\_\_\_
- Holmes \_\_\_\_\_
- Gandy \_\_\_\_\_

FAT:elk (5)

DEM/ASD

GCM

EM/...

SEE NOTE ON PAGE TWO

Letter to San Diego  
Re: SD 1155-E  
137-17222

In the future you should be certain that request for payment authorization is submitted at least two weeks in advance of the effective date.

NOTE:

This is a continuation of previously authorized payment levels. Informant is a member of the Secret Army Organization (SAO) in San Diego, California, and is the principal informant reporting on this and other right-wing groups in the San Diego area. He has also furnished considerable valuable information concerning revolutionary activities groups and anti-law enforcement demonstrations. Specifically, he has furnished 83 reports concerning several functions and 30 to 40 individuals. Ninety-five per cent of the information furnished by him has been verified through other sources. He has reported data concerning contacts between the SAO and the Minutemen including the branch headed by Jesse Stevens in Maryland with regard to possible alliance being formed between these two groups. He has been in contact with the leader of the National Socialist White Peoples Party (NSWPP); has reported on the acquisition of weapons and explosives by the San Diego members of SAO; and has provided substantial information regarding finances and sources of funds of SAO. He furnished data concerning sale and delivery of weapons and other military surplus items by an individual from the Seattle, Washington, area. Based on quality and quantity of information, payments are fully justified.



UNITED STATES GOVERNMENT

# Memorandum

TO: *[Handwritten initials]* ACTING DIRECTOR, FBI (137-17222) DATE: 6/20/72

FROM: SAC, SAN DIEGO (170-286)(P)

SUBJECT: *CONF. INFO.*  
*[Redacted]*  
EM-SAO

*7-13*

*Held*

Re: EXTREMIST OR SECURITY INFORMANT PROGRESS/JUSTIFICATION LETTER

I.  (a) I recommend that authority be granted to continue captioned informant for a period of \_\_\_\_\_ months effective \_\_\_\_\_ and that he continue to be paid under the authority of the Special Agent in Charge, UACB.

(b) I recommend that authority be granted to pay captioned informant an amount up to \$ \$250.00 per  month  week for services rendered on a c.o.d. basis, and up to \$ 100.00 per  month  week for expenses actually incurred for a period of Six (6)  months  weeks effective 6/1/72.  
(If increase, furnish full justification under "Miscellaneous.")

*FAT/KKK*  
*6/20/72*  
*6/21/72*

COPIES TO FILE

*38*

II. Membership: Informant is a member of the Secret Army Organization (SAO) in the San Diego, California, area.

Amount paid for services and expenses:

(SEE PAGE 1-A)

*10/11*  
*11/22/44*

Number of activities and persons on whom coverage is provided:

Informant reports regularly on activities of 30 to 40 individuals associated with the SAO organization and related right wing groups in the San Diego, California area. He continues to be employed by the San Diego City Fire Department which employment affords him considerable free time which he can use to observe and report on activities of many radical and militant individuals and organizations on and off college campuses in the San Diego area.

EX-112

*83-36*

Number of statements (written and oral) submitted: 117-17012-16

Considered stable and reliable  Yes  No (Explain in "Miscellaneous.")

Indoctrinated against disclosure  Yes

Percentage of information verified 95%

*7-3*  
JUN 23 1972

All necessary action taken on information furnished  Yes  No (Explain in "Miscellaneous.")

3 - Bureau (RM)  
1 - San Diego

*EX-112*  
*[Handwritten signature]*

SD 170-286

Amount paid for services and expenses:

<u>PERIOD</u>	<u>SERVICES</u>	<u>EXPENSES</u>
12/1 - 31/71	\$215.00	\$38.75
1/1 - 31/72	220.00	22.40
2/1 - 29/72	205.00	50.00
3/1 - 31/72	205.00	31.40
4/1 - 30/72	220.00	52.70
5/1 - 31/72	215.00	27.19

Summary of information furnished: (If more space needed, add addendum.)

157-7357-11  
On January 28, 1972, source advised that the SAO had been contacted by Newsweek magazine and also by a San Diego daily newspaper, The Evening Tribune, asking for interviews for articles they wished to run on the organization.

During the early part of 1971 source made available a list of several hundred names which were represented to him as being a mailing list compiled by TROY HAUGHTON, former West Coast Leader of the Minutemen Organization. Furthermore, source made available copies of all printed matter distributed by the SAO and furnished information relating to contact between the SAO and a Minutemen type group being operated by an individual named JESSE CLAYBURN STEVENS at Silver Springs, Maryland, and the possible formation of an alliance of these two groups.

(SEE ADDENDUM)

Miscellaneous: (Furnish steps being taken to advance informant, and any other pertinent information which should be brought to Bureau's attention.)

Informant has been instructed to report on compensation received from the Bureau for services as income when filing his income tax return and he has agreed to comply.

Informant has been encouraged to take advantage of any opportunities to improve his coverage of activities of interest to the Bureau in the San Diego area. Through his close association with individuals involved in extremist activities in the San Diego area, he has been able to achieve a leadership position in these activities, particularly in the newly formed Secret Army Organization.

Delay in submission of this letter was caused by the urgency of other important investigative matters having to do with protection of presidential candidates and preparation for the 1972 Democratic and National Conventions.

In January, 1972, source contacted GERALD LEE SMITH, leader of the National Socialist White People's Party (NSWPP) at San Diego, and provided information relating to his philosophies, plans and activities. Through contact with associates who are familiar with NSWPP activities, source generally has been able to stay abreast of important happenings of that organization, and has attended some public meetings of the group.

During the period in question source has provided a large quantity of information relating to the acquisition and use of weapons by members of the SAO and related individuals. In January source advised that JERRY LYNN DAVIS, San Diego area leader of the SAO, claimed to have obtained the keys to the powder magazine of a large sand and gravel company in the area, and that in the future he planned to enter the magazine, take away as much of the explosives as possible and then blow up the rest to destroy any evidence of the theft.

In February, 1972, source advised of efforts by DAVIS to obtain two 81 mm mortars from two unidentified individuals at Los Angeles, California. He further reported on the acquisition of a complete military radio by the SAO known to him, which he has continued to do throughout the reporting period. In this regard he has identified several new members of the group as well as associates of these members, and also potential members of the organization. Source has furnished information pertaining to the relocation of several of these individuals to other parts of the country, particularly BETTIE HAUGHTON, wife of TROY HAUGHTON, who moved to a remote part of California in March and subsequently remarried.

In March the source provided information about the finances of the SAO and the sources of its funds. He also advised of the travel to San Diego by CY ANDERSON of Seattle, Washington, who brought with him a large quantity of weapons, military surplus items and other articles to sell.

SD 170-386

In May, 1972, source identified CLAVIN HENDELL FOX as a new member of the SAO and furnished information regarding travel to Washington, D.C., by FOX to participate in a victory march sponsored there by Reverend CARL MC INTYRE.

UNITED STATES GOVERNMENT

# Memorandum

TO : ACTING DIRECTOR, FBI (137-17222) DATE: 11/20/72

FROM : *S/Ch* SAC, SAN DIEGO (170-286) (P)

SUBJECT: HOWARD BARRY GODFREY  
(Formerly ~~██████████~~)  
SI - SAC, MINUTEMEN  
(OO: San Diego)

Re San Diego letter to Bureau dated 6/20/72 and Bureau letter to San Diego dated 7/3/72.

Source was contacted on November 14, 1972, and was advised that since he had left the area and would not be able to furnish information to the Federal Bureau of Investigation concerning activities in San Diego, his agreement to furnish information to the Bureau was terminated as of that date and he would no longer be operated by the Bureau.

Source stated that he is willing to testify in Federal, State or Local court or before a congressional hearing if subpoenaed for such testimony. He was reminded that he should continue to be factual and truthful in any such testimony and that he should not embellish his statements in any way. He has been advised that he will testify in a Federal trial of subject, THOMAS LEE FORREST, where the Bureau of Alcohol, Tobacco and Firearms, San Diego, is prosecuting FORREST for the sale of automatic weapons conversion kits.

Source is presently testifying in San Diego County Superior Court in a case involving GEORGE MITCHELL HOOVER, Secret Army Organization (SAO) member, who is charged with attempted murder. He will testify in cases involving

- ② - Bureau
- 2 - Los Angeles
- 2 - San Diego

MP/ed  
(6)

REC-25

137-17222-17

ST 101

NOV 24 1972

*[Handwritten signature]*  
INT. SEC.

170 DEC 5 1972



SD 170-286

JERRY LYNN DAVIS, SAC leader, for possession of explosives; DINO MARTIN'LL, and CALVIN HENDALL FOX for perjury in the trial of WILLIAM FRANCIS YAKOPEC, who was found guilty of the bombing of the Guild Theatre in San Diego. YAKOPEC was sentenced to one year to life and a concurrent sentence of one to five years on another charge. He will keep the Federal Bureau of Investigation advised of any further testimony required of him.

Source was advised that because of publicity resulting from his exposure as an FBI paid informant during the trials now in progress, he might be contacted by the press, radio or television for public appearances. He advised that he will always feel free to contact the Bureau for assistance and guidance if he is contacted to make any kind of public appearance.

He advised that he has been contacted by an individual named LAURITZ P. MILLER, 8337 Castano Place, Sun Valley, California, who advised him that he is a writer and would like to cooperate with him in the writing of a book regarding "right wing" activities, including that of the Secret Army Organization. MILLER claims to have some information already in his possession regarding "right wing" organizations.

Source stated that he is giving serious consideration to writing a book and that he will appreciate any advice and guidance the Bureau can give him. The book would place the FBI in a favorable light. He requested that he be advised if the Bureau has any information concerning MILLER which would make it undesirable to work with him on the book.

Source was advised that the Bureau will not sponsor or endorse any book or publication he might write.

Flash notice on source <sup>will</sup> ~~has been~~ removed *in ONE YEAR,*

SD 170-286

No FD 401 being submitted. Source has been paid the following amounts for services and expenses since June 1, 1972:

<u>Date</u>	<u>Services</u>	<u>Expenses</u>
7/10/72	\$250.00	\$100.00
7/10/72	-	\$200.00
8/3/72	\$250.00	\$100.00
9/6/72	\$150.00	-
11/14/72	\$100.00	-

LOS ANGELES

Search Indices regarding LAURITZ P. MILLER, 8337 Castano Place, Sun Valley, California, and advise Bureau and San Diego of any pertinent information.



UNITED STATES GOVERNMENT

# Memorandum

TO : ACTING DIRECTOR, FBI (137-17222)

DATE: 12/22/72

FROM : ASSISTANT DIRECTOR, LOS ANGELES  
(157-8214) (RUC)

SUBJECT:

HOWARD BARRY GODFREY  
(formerly ~~██████████~~)  
EM - SAO, MINUTEMEN  
OO: San, Diego

Re San Diego letter to the Bureau, dated 11/20/72.

On 8/11/72, Mr. LAURITZ P. MILLER, 8337 Castano Place, Sun Valley, California, wrote a letter to the Acting Director, FBI, in which he advised as follows:

MILLER, a free-lance writer, had recently returned to Los Angeles from Japan, where he had researched a potential story on the Japanese terrorist groups that provided three gunmen for the Lod Airport massacre in Tel Aviv, Israel, 5/30/72. According to information learned by MILLER there was a strong indication of a world-wide Communist conspiracy dedicated to international revolution. Mr. MILLER related some of the facts which he learned concerning the Red Army group in Japan and its ties to revolutionary groups throughout the world.

On 8/23/72, Mr. MILLER was interviewed concerning details of the information which he had related in his letter to the Bureau. After the interview MILLER produced several books written in Japanese which he had had partially translated and which were extremely revolutionary and violent in nature. These books were forwarded to the Bureau for complete translation.

Mr. MILLER seemed to be a reasonable man who was very concerned about the dangers posed by terrorists organizations throughout the world.

REC-49 137-17222-18

- 2 - Bureau (RM)
- 2 - San Diego (170-286) (RM)
- 1 - Los Angeles

ST-115

JAN 2 1973

JCD/clg  
(5)

JAN 9 1973

*[Handwritten signature]*

FBI

Date: 3/1/73

Transmit the following in \_\_\_\_\_  
(Type in plaintext or code)

Via AIRTEL \_\_\_\_\_  
(Priority)

TO: ACTING DIRECTOR, FBI (157-17222) ATTN: OFFICE OF LEGAL COUNSEL  
FROM: SAC, SAN DIEGO (170-286) (P)

HOWARD BARRY GODFREY  
FORMER [REDACTED]  
EM - SAO  
(OO: San Diego)

Re San Diego letter to Bureau dated 11/20/72; Los Angeles letter to Bureau dated 12/22/72.

On 2/26/73, LAURITZ P. MILLER, Sun Valley, California, telephone (213) 767-3581, telephonically contacted SA EARL M. PETERSEN stating that he was planning to assist former FBI informant HOWARD BARRY GODFREY in writing a book concerning his experiences while assisting the FBI. He advised that the book will be pro-FBI and will be as factual as possible. He stated that he would like to verify that GODFREY had actually reported to the FBI some of the things that he has reported to him in discussing the preparation of the book.

HOWARD BARRY GODFREY was formerly [REDACTED]

MILLER was advised that he could be furnished no information without the specific authority of the Acting Director of the FBI and, possibly, the additional approval of the U. S. Department of Justice.

MILLER stated that it is his intention to prepare a letter to the Acting Director of the FBI setting forth information concerning the book he intends to write and requesting authority to obtain information that he needs to verify the authenticity of information furnished by GODFREY.

- 2 - Bureau (RM)
- 1 - Los Angeles (157-3214) (INFO) (RM)
- 2 - San Diego

BHP:elb  
(5)

DECLASSIFIED

25 MAR 3 1973

Handwritten notes and stamps, including "NOTED" and "19".

February 28, 1973

Mr. Hoover  
Mr. Helm  
Mr. Harington

Mr. Felt  
Mr. Baker  
Mr. Callahan  
Mr. Cleveland  
Mr. Conrad  
Mr. Gerhardt  
Mr. Jenkins  
Mr. Marshall  
Mr. Miller, E.S.  
Mr. Parris  
Mr. Soyars  
Mr. Walters  
Tele. Room  
Mr. Kinley  
Mr. Armstrong  
Mr. Bowers  
Mr. Harrington  
Ms. Herwig  
Mr. Mintz  
Mrs. Neenan

Patrick L. Gray, Director  
Federal Bureau of Investigation  
Washington, D.C. 20535

BP  
Dear Sir:

As you have been informed by Agent Earl Peterson of San Diego I am collaborating with Howard Barry Godfrey to produce a book based on his experiences as an informant for the Bureau.

I would like to assure you we intend to present the Federal Bureau of Investigation in only a favorable way.

Our motive for writing this book is to alert the general public of a dangerous situation developing (and in some cases well established) in every major community in the nation.

Godfrey wants to lay out the nation network of communication between extremist groups, both right and left wing.

He plans to recount as much detail as possible of his years as a member of these extremist groups, explaining the recruiting, training, assignment and some actual operations accomplished by them.

It would be of great assistance to us if you would authorize me to interview Agent Peterson in San Diego. This would not constitute an endorsement of our Book, but would help me to understand more about Godfrey, the general situation, and the position of the F.B.I. in coping with paramilitary organizations.

I will naturally agree to any conditions you suggest for holding such an interview.

32 MAR 2 1973  
137-17222-  
NOT RECORDED  
MAR 20 1973  
FILED IN 62-109

see Brownfield  
Stinkins memo  
3-8-73  
A.E.S. dky

Act let  
3-9-73  
HES:dky

~~1~~ MAR 2 1973

NOT RECORDED  
FILED

Hoping to hear from you soon, I remain

Very truly yours,

LPM: jm

UNITED STATES GOVERNMENT

# Memorandum

TO : Mr. Jenkins *TOGA*

FROM : T. J. Brownfield *TJB*

DATE: 3-8-73

- Mr. Felt \_\_\_\_\_
- Mr. Baker \_\_\_\_\_
- Mr. Callahan \_\_\_\_\_
- Mr. Cleveland \_\_\_\_\_
- Mr. Conrad \_\_\_\_\_
- Mr. Gebhardt \_\_\_\_\_
- Mr. Jenkins \_\_\_\_\_
- Mr. Marshall \_\_\_\_\_
- Mr. Miller \_\_\_\_\_
- Mr. Soyars \_\_\_\_\_
- Mr. Thompson \_\_\_\_\_
- Mr. Walters \_\_\_\_\_
- Tele. Room \_\_\_\_\_
- Mr. Kinley \_\_\_\_\_
- Mr. Armstrong \_\_\_\_\_
- Mr. Bowers \_\_\_\_\_
- Mr. Herington \_\_\_\_\_
- Ms. Hervig \_\_\_\_\_
- Mr. Mintz \_\_\_\_\_
- Mrs. Neenan \_\_\_\_\_

SUBJECT: LAURITZ P. MILLER  
FREE LANCE WRITER,  
SUN VALLEY, CALIFORNIA  
REQUEST TO INTERVIEW SA EARL M.  
PETERSEN, SAN DIEGO OFFICE

*Slip*  
*5 Miller*  
*Menzel*

BACKGROUND:

By letter dated February 28, 1973, Miller advised he is collaborating with Howard Barry Godfrey to produce a book based on Godfrey's experiences as an FBI informant. Although the letter was unsigned, it bore letterhead information including Miller's name and address, 8337 Castano Place, Sun Valley, California. Miller's stationery described him as a "Freelance Writer-Photographer-Editor." Miller said he and Godfrey intended to present the FBI "in only a favorable way," and that Godfrey would describe "the nation network of communication by the extremists groups, both right and left wing," recounting his years as a member of these extremists groups.

Miller requested authorization for interview of "Agent Earl Peterson of San Diego" (SA Earl M. Petersen), explaining the interview "would help me to understand more about Godfrey, the general situation, and the position of the F.B.I. in coping with paramilitary organizations."

By airtel dated March 1, 1973, the San Diego Office advised that Miller had telephonically contacted Special Agent Petersen regarding interviewing him and that Miller was advised he could be furnished no information without the specific authority of the Acting Director of the FBI and, possibly, the additional approval of the Department of Justice.

INFORMATION IN BUFILES:

Regarding Godfrey:

Howard Barry Godfrey, born July 1, 1943, at Portsmouth, England, was designated a symbol-number informant

Enclosure *sent 3-9-73 mb*

- 55 MAR 28 1973
- 1 - Mr. Jenkins - Enclosure
- 1 - Mr. Miller - Enclosure
- 1 - Mr. Mintz - Enclosure

NOT RECORDED  
178 MAR 23 1973

CONTINUED - OVER

ORIGINAL FILED IN 69-115975-12

Brownfield to Jenkins Memo  
RE: LAURITZ P. MILLER

of the San Diego Office August 10, 1967, while employed as an equipment-checker for Pacific Telephone and Telegraph Company, San Diego, California. A gun hobbyist, Army trained in the use of explosives, he became associated with the top echelon of the Minutemen as well as the Secret Army Organization (SAO), furnishing excellent information to the FBI regarding these and other extremists groups.

By communication dated November 20, 1972, the San Diego Office discontinued Godfrey as an informant. Godfrey had testified in San Diego County Superior Court in the trial of George Mitchell Hoover, SAO member charged with attempted murder, and in the trial of William Francis Yakopec, who was found guilty of the bombing of the Guild Theater in San Diego. At that time, Godfrey also was scheduled to testify against Jerry Lynn Davis, SAO leader charged with illegal possession of explosives.

SA Petersen also testified in Hoover's trial and had been Godfrey's contacting Agent.

As a result of Godfrey's appearances as a prosecution witness, his identity as an FBI informant was publicized in the news media. (137-17222, 157-17513-10)

Regarding Miller:

Our files show that by letter dated November 30, 1971, Miller requested information regarding crimes committed by juvenile females. He was furnished a Uniform Crime Reports Bulletin.

Miller wrote to Acting Director Gray August 11, 1972, furnishing information regarding what he considered to be a world-wide communist conspiracy for revolution, including direct communication between U. S. revolutionaries and the Japanese. Miller stated that some American servicemen were sympathetic with the world revolutionaries and were being used as couriers. Miller explained he had developed this information while doing research in Japan. He requested information as to whether the FBI knew of the "situation."

By airtel August 21, 1972, the Los Angeles Office was advised of Miller's August 11th letter and was instructed to interview him. The Los Angeles Office further was instructed to advise Miller of the confidential nature of information contained in Bureau files and to alert him regarding the jurisdictions of the respective military services over their personnel.

Brownfield to Jenkins Memo  
RE: LAURITZ P. MILLER

Miller was subsequently advised by the Los Angeles Office per instructions and the information he furnished was forwarded to the Legal Attache, Tokyo.

Miller also furnished similar information directly to the Japanese National Police Agency (NPA), in August, 1972. The NPA in October, 1972, advised the Legal Attache, Tokyo, that NPA's inquiry failed to substantiate Miller's allegations. (62-115275)

ADDITIONAL INFORMATION:

On March 6, 1973, ASAC Clark F. Brown, San Diego Office, was telephonically advised of Miller's request to interview SA Petersen in connection with the projected book. ASAC Brown was advised that interview of SA Petersen would not be authorized in view of regulations regarding revealing information in Bureau files.

This matter has been coordinated with the Intelligence Division and James L. Williamson of the Office of Legal Counsel.

RECOMMENDATION:

That the attached reply be sent to Miller.

H  
11/29

JLM

UNITED STATES GOVERNMENT

# Memorandum

TO : ACTING DIRECTOR, FBI (137-17222)  
ATTN: FBI LABORATORY, FIREARMS SECTION

DATE: 4/30/73

FROM : SAC, SAN DIEGO (170-286)(C)

SUBJECT: HOWARD BARRY CODERLEY  
FORMERLY ██████████  
EM - SAO CONF. INPT.

*W. Wilder*  
*4*  
*3*

Source made available a number of items during his activity as a source within the Secret Army Organization (SAO). He has authorized disposal of these items in any way seen fit by the San Diego Office of the FBI. The remaining items not used as evidence and not destroyed are:

One Browning Machine Gun, Caliber 50M2, U. S. Number 32846, manufactured by Colts Patent Firearms Manufacturing, Col., Hartford, Connecticut. This weapon is completely disassembled and the barrel has been cut off with a welding torch. This weapon was removed from a wrecked airplane on the desert and it was necessary to cut off the barrel to get the weapon out of the plane.

One .38 Caliber Silencer, no brand name, with Patent Pending and the number 96 stamped on it. Blue steel.

One sawed off shotgun barrel and stock (also sawed off) from Sears Roebuck model 1001.100 shotgun, no serial number. Barrel 13 1/2 inches long.

Two rifle grenade launchers. No identifying marks.

ST-104

REC-23

137-17222-20

The above-listed items are forwarded to the Firearms Section for disposal or for any other use desired of them.

- 3 - Bureau
- 1 - Package
- 1 - San Diego

EMP:mlr  
(5)

MAY 2 1973

*Handwritten signatures and initials*



- 1 - General Investigative Division
- 1 - External Affairs Division
- 1 - Mr. D. W. Bowers
- 1 - Mr. H. A. Newman
- 1 - Mr. P. E. Nugent
- 1 - Mr. F. A. Tansey
- 1 - Mr. T. Fitzpatrick

Mr. W. R. Wannall

2/7/74 1 - Mr. W. R. Wannall  
1 - Mr. G. C. Moore

G. C. Moore

THREE ANTI-FBI ARTICLES  
 APPEARING IN FEBRUARY, 1974, ISSUE OF  
 NATIONAL STATES RIGHTS PARTY (NSRP)  
 NEWSPAPER "THE THUNDERBOLT"  
 EXTREMIST MATTER - NSRP

Page 8 of the February, 1974, issue of "The Thunderbolt" (TT), a monthly newspaper of the NSRP, contains three articles critical of the FBI and, in part, of former Director J. Edgar Hoover. The NSRP is an antiblack, anti-Semitic, white racist political party headquartered in Marietta, Georgia, which is composed of past members of klan-type organizations. TT is edited by Dr. Edward R. Fields who is NSRP National Secretary.

The lead article is captioned "FBI Turned Into Secret Police." It discusses a lengthy written report allegedly given by former FBI Assistant to the Director William C. Sullivan to the White House, in which Sullivan "revealed" former Director Hoover "was not of sound mind in his last years"; how Director Hoover allegedly "kept files on Congressmen and blackmailed them"; and how the FBI allegedly committed illegal acts in "prosecuting white patriots" for many years. The article alleges that former White House aide John Dean III gave a copy of Sullivan's report to the Senate Watergate Committee (SWC); however, the SWC has allegedly suppressed it. Readers are urged to write their Congressmen and the SWC demanding release of the "Sullivan Report."

The article further alleges the FBI has been "wrecking patriotic organizations" while only "giving lip service to the fight against communism," and has experienced a "loss of reputation."

Enclosures (3)

105-66233

- 1 - 137-17222 (Howard Godfrey)
- 1 - 157-23577 (SLO)

EF:lnk (12)

137-17222 -  
 201 FEB 27 1974

CONTINUED - OVER

54 MAR 5 1974

Memorandum to Mr. W. R. Wannall  
Re: Three Anti-FBI Articles  
Appearing in February, 1974, Issue Of  
National States Rights Party (NSRP)  
Newspaper "The Thunderbolt"

It says a need exists to repeal antigun and similar laws that enable Federal agents to "impose a police state." An analogy is made between alleged FBI tactics and Russian "secret police" tactics. The article closes by urging readers to refuse to answer questions from "federal agents."

The second article is a reprint from the "Atlanta Journal," 5/15/73 issue, by Jack Nelson, captioned "FBI's Hoover Called 'Not Of Sound Mind.'" The article essentially states that wiretap files located by the FBI in a White House safe were kept from former Director Hoover because he was "not of sound mind in his last years." Former FBI official William Sullivan reportedly turned the files over to then Assistant Attorney General Robert Hardin, before "Hoover forced Sullivan to retire from the FBI on October 6, 1971," since the late Director "could not be trusted to keep the records confidential." Sullivan is quoted as saying former Director Hoover "was a master blackmailer... with considerable finesse, despite the deterioration of his mind."

The third article is captioned "FBI Francup Fails." It relates that George M. Hoover, a member of the Secret Army Organization (SAO) was convicted last year of firing into the home of a "Marxist radical" of San Diego, California. This conviction was overturned on appeal on the basis the jury should have been informed the sole witness testifying against Hoover was a "paid FBI informant." This informant is identified as Howard Berry Godfrey, and the article alleges Godfrey "constantly encouraged violence," was "allowed" by the FBI to participate in acts of violence, and used "entrapment" to involve Hoover in the shooting incident. It is stated this successful appeal by Hoover of his "francup" is an "outstanding victory for patriots everywhere," and exposes "how far Government agents will go to wreck patriotic groups."

CONTINUED - OVER

Memorandum to Mr. W. P. Wannall  
Re: Three Anti-FBI Articles  
Appearing in February, 1974, Issue Of  
National States Rights Party (NSRP)  
Newspaper "The Thunderbolt"

SAO is a now defunct organization formed in San Diego, California, in 1971 as an anticommunist, paramilitary group. SAO intended to conduct intelligence-type investigations and to offer urban guerrilla training for use against "left-wing groups and suspected enemies of the U. S."

Godfrey was a San Diego Division extremist informant from 12/6/68 to 11/20/72. He was targeted to penetrate the SAO and subsequently became a SAO leader. We have no confirmed information ~~in our files~~ indicating his actual participation in "entrapment" were raised by the defense along this line during Hoover's trial and these allegations were refuted or explained in open court. Godfrey's testimony was instrumental in achieving successful prosecutions against several SAO members, and thereby producing the demise of the SAO.

Copies of the above three articles are attached.

ACTION:

None. For information. This newspaper has a small circulation aimed at its white hate membership. We are not refuting the allegations therein as to do so would serve no useful purpose and would merely prompt the NSRP to prolong these attacks.

February 1974 Issue  
 (DR - had a fields - edit)

# FBI Turned Into Secret Police

J. EDGAR HOOVER  
 WAS A MENTAL CASE  
 AND A BLACKMAILER

For many years, William C. Sullivan was assistant director to J. Edgar Hoover at the FBI.

In fact, Sullivan was the main public spokesman for the FBI and Hoover, except on those

occasions when Hoover personally spoke. Sullivan often spoke to conventions and important meetings in behalf of Hoover. If any man on the inside ever knew what Hoover really was, it was Assistant Director of the FBI William C. Sullivan.

William C. Sullivan gave a long written report to the White House in which he revealed that J. Edgar Hoover was not of sound mind in his last years. This was a long report which spelled out many of Hoover's illegal activities. He also told how Hoover kept files on congressmen and senators and blackmailed them during the forty eight years that he headed the FBI.

It is bad enough for a man to be a blackmailer and of unsound mind, but much worse when that man is the head of the nationwide secret police that has files on over half the American people...

Jew Daniel Ellsberg stole military secrets and has been accused of giving them to Russia. Yet, Hoover refused to investigate Ellsberg because of his friendship with Ellsberg's father-in-law, Jew Louis Marx. It is tragic when the chief of the secret police is surrounded with Jews.

William C. Sullivan gave his report to the White House. Then, the Senate Watergate Committee was given the report by John Dean, 3rd. The Watergate Committee has suppressed the Sullivan report ever since. They don't want the people to know the truth about how the FBI has been used to commit burglary, perjury, and break other laws in persecuting loyal White patriots throughout the country for many years. It would be well for every person to write to the senators on the Watergate Committee and demand that they release and publish the full text of the Sullivan Report which exposes the evils of the FBI.

A federal court recently ordered the FBI to turn over some of its documents on investigations to a reporter. The documents showed that the FBI had been illegally working for years and years not only to spy upon rightwing patriotic organizations, but to also sabotage them. The only leftwing organizations sabotaged by the FBI were those that had splintered and broken away from the discipline of the main communist movement.

137-17222 -

Enclosure

# FBI's Hoover Called

## "Not Of Sound Mind"

By JACK NELSON  
WASHINGTON (LAT) — Wiretap files located by the FBI in a White House safe were kept from J. Edgar Hoover because he was "not of sound mind" in his last years, William C. Sullivan, former FBI assistant director told the Los Angeles Times Monday.

Sullivan said that because the late FBI director "could not be trusted" to keep the files confidential Sullivan turned them over to Assistant Atty. Gen. Robert Mardian before Hoover forced Sullivan to retire from the FBI on Oct. 6, 1971.

Sullivan, now director of the Justice Department's office of national narcotics intelligence, said John N. Mitchell, who was attorney general at the time, ordered that the files be given to Mardian.

Acting FBI Director William B. Ruckelshaus quoted Mardian as saying he transferred the files after Sullivan warned that Hoover "might use the records in some manner" against President Nixon and Mitchell.

RUCKELSHAUS said Sullivan did not "affirm" Mardian's claim in a statement to the FBI. But Sullivan told the Times he and Mardian did agree that Hoover might use the files for "some ill-conceived purpose" against government officials. "I don't specif-

ically remember mentioning the President," Sullivan said, "but we certainly had the President in mind."

Sullivan, who feuded with Hoover over FBI policy matters in the last few years before the director's death in May 1972, said that the wiretap records never were a part of the FBI's officially recorded files.

"Hoover didn't want the records in the official file," Sullivan said. "He told me to keep them myself and have them ready for him, available any time he wanted them. I had them in a file cabinet in my office, but they were never serialized or recorded in the FBI files."

Sullivan said that when Justice Department officials who knew of the wiretap records learned he was leaving "they were very upset and understandably because they could no longer depend on Hoover. He had been leaking stuff all over the place. He could no longer be trusted. So I was instructed to pass the records to Mardian."

HOOVER, who had been under considerable criticism for his administration of the FBI, was concerned about being fired as director and kept the records "to keep Mitchell and the others in line," Sullivan said.

That fellow was a master blackmailer and he did it with considerable finesse despite the deterioration of his mind, Sullivan said.

"He always did that sort of thing. The moment he would get something on a senator he's send one of the errand boys up and advise the senator that we're in the course of an investigation and we by chance happened to come up with this data on your daughter. But we wanted you to know this — we realize you'd want to know it. But don't have any concern, no one will ever learn about it. Well, Jesus, what does that tell the senator? From that time on the senator's right in his pocket."

Sullivan said that neither Mitchell nor Mardian ever specifically told him that they did not want Hoover to have the files because he could not be trusted. But Sullivan said he could "read this between the lines."

"NEITHER MARDIAN nor Mitchell trusted him but they didn't want to say that," Sullivan said. "Hoover wasn't of sound mind — as a matter of fact a high administration official once said Hoover had been of unsound mind for the past few years. Everybody who had anything to do with Hoover knew that he was no longer rational. He was doing the strangest things, like going into a rage."

37-172-52

Enclosure

# FBI Frameup Fails

## CALIFORNIA PATRIOT FREED IN FBI FRAMEUP CASE

Mr. George M. Hoover was a member of the now defunct right-wing "Secret Army Organization." Hoover, age 37 of Santee, California, was convicted last year of firing into the home of a Marxist radical named Peter Bohmer of San Diego.

It was later admitted by the federal prosecution that an FBI pimp named Howard Berry Godfrey had infiltrated the Secret Army. He had driven the car from which the shots were fired. Therefore the California Fourth District Court of Appeals ruled to overturn Hoover's conviction. Judge William T. Low said the jury should have been informed that the sole witness testifying against Hoover, and driver of

the car, was a paid FBI informer.

It was also charged that the pimp, Howard Godfrey, was the chief "firebrand" in the Secret Army and constantly encouraged violence. The FBI allowed Godfrey to participate in the shooting, several firebombings and burglaries before they arrested several others using Godfrey as their main witness against them.

Godfrey was so convincing that he rose to Assistant State Coordinator of The Secret Army. Through acts of violence he was able to prove his "loyalty" to the organization. The court deemed this an act of "entrapment." The FBI pimp was the provocateur of the acts of violence and his FBI superiors had the power to stop them before they occurred.

**RIGHT-WING VICTORY**

This important case represents an outstanding victory for Patriots everywhere. The victory of George M. Hoover over this FBI frameup helps to expose how far government agents will go to wreck patriotic groups. The disturbing part of this is that the FBI will itself break the law, with acts of violence, in order to maneuver innocent patriots into a trap, where they can then be framed by lying paid pimps testifying in court.

While this sort of skullduggery has been going on for some time, the true facts behind it all are just now coming to light. We have all read the chilling accounts of secret police terror in Russia and now we witness the very same thing taking place right here in this country.

137-17222 -

1/21/70

Mr. J. B. Adams

June 23, 1975

Legal Counsel

PETER LOEWNER, et al., v.  
RICHARD MILHOUS NELSON, et al.  
(U.S.D.C., CALIFORNIA)  
CIVIL ACTION NO. 75-4-T

In captioned civil action plaintiffs Peter Bohmer and Paula Tharp allege that defen. acts conspired to deprive them of rights, privileges and immunities secured to them by the Constitution and laws of the United States. Defendants include SAC Rex L. Schroder, San Diego, former San Diego AEAC Clark F. Brown, presently assigned Inspection Division, SA C. Jordan Naylor and SA Earl M. Petersen, San Diego, former SA Steven L. Christensen, and Howard Barry Godfrey, a former San Diego informant. A litigation report was submitted to the Department by memorandum to the Assistant Attorney General, Criminal Division, dated 5/23/75.

On 6/13/75, Benjamin C. Flanagan, Senior Trial Attorney, Special Litigation Section, Criminal Division, advised that former San Diego FBI informant Howard Barry Godfrey, who reported on rightist activities, had requested Departmental representation in this civil action and that the Department has agreed to represent Mr. Godfrey. Mr. Flanagan asked whether this Bureau had any objection to Mr. Godfrey's representation by the Department.

Enclosure (1)

137-17222

1 - 100-470802

1 - Mr. Wannall

1 - Mr. Dulladway

2 - Mr. Mintz

1 - Mr. Latorno

GML:kiw

(9)

JUL 2 1975

137-17222  
NOT RECORDED  
JUL 10 1975  
(CONTINUED OVER)

ORIGINAL FILED IN 137-17222-9

Memo to Mr. J. B. Adams  
Re: Peter Bohmer, et al., v.  
Richard Milhous Nixon, et al.  
Civil Action No. 75-4-1

The attached memorandum to the Department indicates we have no objection to the Department affording Mr. Godfrey representation as long as his interests do not conflict with the interests of defendant FBI personnel.

RECOMMENDATION:

That the attached memorandum to the Assistant Attorney General, Criminal Division, be approved and sent.



Mr. J. B. Adams

June 23, 1975

Legal Counsel

PETER BOHNER, et al., v.  
RICHARD MILTON NIXON, et al.  
(U.S.E.C., CALIFORNIA)  
CIVIL ACTION NO. 75-4-T

In captioned civil action plaintiffs Peter Bohner and Paula Sharp allege that defendants conspired to deprive them of rights, privileges and immunities secured to them by the Constitution and laws of the United States. Defendants include SAC Rex L. Shroder, San Diego, former San Diego ASAC Clark F. Brown, presently assigned Inspection Division, SA C. Jordan Naylor and SA Earl M. Peterson, San Diego, former SA Steven L. Christensen, and Howard Barry Godfrey, a former San Diego informant. A litigation report was submitted to the Department by memorandum to the Assistant Attorney General, Criminal Division, dated 5/23/75.

On 6/13/75, Benjamin C. Flanagan, Senior Trial Attorney, Special Litigation Section, Criminal Division, advised that former San Diego FBI informant Howard Barry Godfrey, who reported on rightist activities, had requested Departmental representation in this civil action and that the Department has agreed to represent Mr. Godfrey. Mr. Flanagan asked whether this Bureau had any objection to Mr. Godfrey's representation by the Department.

Enclosure (1)

① 137-17222

~~137-17222~~

1 - 100-470202

1 - Mr. Wannall

1 - Mr. Duffadway

2 - Mr. Mintz

1 - Mr. Laturno

GML:kiw

(9)

JUL 24 1975

137-17222

NOT RECORDED

15 JUL 10 1975

(CONTINUED OVER)

ORIGINAL FILED IN 137-17222-115

Memo to Mr. J. B. Adams  
Re: Peter Lubner, et al., v.  
Richard Milhous Nixon, et al.  
Civil Action No. 75-4-T

The attached memorandum to the Department indicates we have no objection to the Department affording Mr. Godfrey representation as long as his interests do not conflict with the interests of defendant FBI personnel.

RECOMMENDATION:

That the attached memorandum to the Assistant Attorney General, Criminal Division, be approved and sent.

6/5/75

AIRTEL

AIRMAIL

TO: DIRECTOR, FBI (100-461715) (100-470202)  
ATTN: LEGAL COUNSEL DIVISION

FROM: SAC, SAN DIEGO (62-2248) (P)

PETER BOHMER, ET AL  
versus  
RICHARD MILHOUS NIXON, ET AL  
(United States District Court  
San Diego, California)  
CIVIL ACTION NO. 75-4-T

Re your call, 6/4/75.

HOWARD BARRY GODFREY is a defendant in captioned case. He has directed a communication to the U.S. Justice Department requesting that he be represented by the Justice Department attorneys in this law suit. GODFREY was a paid informant of the FBI during the period concerned by the allegation in captioned suit.

It is the recommendation of the San Diego Office that the Justice Department represent GODFREY as an agency relationship existed. Also GODFREY's defense by Departmental attorneys would establish continuity to the answers to the complaint. Finally GODFREY was under the impression that his role as an FBI informer would not be made public and place him in the current position of a defendant in a civil action.

3-Bureau  
1-San Diego  
AAR/EMP:kab  
(4)

137-1702-  
NOT RECORDED

46 JUL 10 1975

Assistant Attorney General  
Criminal Division

June 24, 1975

Director, FBI

137-17222

- 1 - Mr. Wannall
- 1 - Mr. DuHadway
- 2 - Mr. Mintz
- 1 - Mr. Latorno

PETER ROSENBERG, et al., v.  
 RICHARD L. ALLENBERGER, et al.  
 (U.S.D.C., CALIFORNIA)  
 CIVIL ACTION NO. 75-2-T

On June 19, 1975, Mr. Flanagan of your office advise I that former San Diego FBI informant Howard Barry Godfrey who reported on rightist activities, had requested Departmental representation in his civil action and that the Department has agreed to represent Mr. Godfrey. Mr. Flanagan asked whether this Bureau had any objection to Mr. Godfrey's representation by the Department.

For your information, we have no objection to the Department affording representation to Mr. Godfrey as long as his interests do not conflict with the interests of defendant FBI personnel. In the event such conflict arises, we do not feel it would be proper or appropriate for the Department to represent him. See Code of Professional Responsibility, Canon 5, Ethical Considerations EC 5-14 through 15.

① 137-17222  
~~1-109-407715~~  
 1 - 100-470202  
 GML:kiw  
 (11)

DUPLICATE YELLOW

ORIGINAL FILED IN



SSC Request 1/20/76  
Item 3 (Re: Secret Army Organization)  
Volume I

Access

# Memorandum

TO : DIRECTOR, FBI (157-23577)

FROM : SAC, SEATTLE (157-1830) (P)

SUBJECT: SECRET ARMY ORGANIZATION (SAO)  
EXTREMIST MATTERS

DATE: 7-27-72

OO: SAN DIEGO

RE: SElet to Bureau 6-15-72.

Since the submission of the above relet, Seattle former sources ~~XXXXXX~~ and ~~XXXXXX~~ were contacted and advised that they have not been able for personal reasons to become active in Minutemen or SAO activities and therefore would be unable to assist this office in this matter.

The Seattle Office is attempting to establish other sources in order to determine if the SAO is a functioning organization within this division. If investigation fails to indicate such, this matter will be administratively closed pending receipt of pertinent positive information that the SAO is an organization in which this office has an interest.

- 2-Bureau (Reg.)
- 2-San Diego (157-2815) (Reg.)
- 2-Seattle

SER:ldk  
(6)

*Handwritten:* H. G. ...  
Ref. ...

EX-102

REC-53 157-23577-36

JUL 31 1972

EXT. FILE SEC.

ALL EXCISIONS UNLESS OTHERWISE NOTED ARE TO PROTECT SYMBOL NUMBER OF INFORMANTS.



AUG 9 1972 U.S. Savings Bonds Regularly on the Payroll Savings Plan

SAC, San Diego (157-2815)

7/25/72

Acting Director, FBI (157-23577)

- 1 - Mr. P. C. Mogen
- 1 - Mr. W. C. Patterson

SECRET ARMY ORGANIZATION (SAO)  
EXTREMIST MATTERS

ReSDlet 6/19/72 captioned "Characterizations of Subversive, Racial, Klan, White Hate and Militant Organizations."

Referenced letter enclosed characterizations and abbreviated thumbnail sketches of various organizations including SAO. In order to abide by instructions set forth on Pages 22 and 22a, Section 4 D, Part II, Manual of Rules and Regulations, the following changes are to be made of the abbreviated thumbnail sketch and the characterization of the SAO and they are to be resubmitted under the caption of this letter.

The abbreviated thumbnail sketch should be changed to

read:

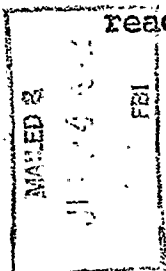

The Secret Army Organization (SAO) is an anticommunist, paramilitary organization formed in 1971 in San Diego, California. It intends to conduct intelligence-type operations and to offer training in urban guerrilla warfare to be used against "left-wing groups" and suspected enemies of the United States.

The characterization should be changed to read:

The Secret Army Organization (SAO) is an anticommunist, paramilitary organization formed during the early part of October, 1971, in San Diego, California, by former members and supporters of Minutemen organization and for the purpose of replacing that organization, which was considered defunct in the San Diego area.

- Felt \_\_\_\_\_
- Bates \_\_\_\_\_
- Bishop \_\_\_\_\_
- Callahan \_\_\_\_\_
- Campbell \_\_\_\_\_
- Cleveland \_\_\_\_\_
- Conrad \_\_\_\_\_
- Dalbey \_\_\_\_\_
- Jenkins \_\_\_\_\_
- Marshall \_\_\_\_\_
- Miller, E.S. \_\_\_\_\_
- Ponder \_\_\_\_\_
- Soyars \_\_\_\_\_
- Walters \_\_\_\_\_
- Tele. Room \_\_\_\_\_
- Mr. Kinley \_\_\_\_\_
- Mr. Armstrong \_\_\_\_\_
- Ms. Herwig \_\_\_\_\_
- Mrs. Neenan \_\_\_\_\_

WCP:aso (5)

REC-37

157-23577-35

SEE NOTE PAGE TWO

ST-111

16 JUL 26 1972

HEH

MAIL ROOM

TELETYPE UNIT

Letter to San Diego  
Re: Secret Army Organization (SAO)  
157-23577

On January 7, 1972, according to a source, the SAO intended to conduct intelligence-type operations and offer training in urban guerrilla warfare to be used against "left-wing groups" and suspected enemies of the United States.

The SAO is headquartered in San Diego, California, and intends to become a nationwide organization.

Submit along with the above characterization on a separate page a characterization of the Minutemen in accordance with instructions cited above.

Handle promptly the submission of the above.

NOTE:

San Diego being requested to submit amended abbreviated thumbnail sketch and characterization.



FEDERAL BUREAU OF INVESTIGATION  
COMMUNICATIONS SECTIC

JUL 20 1972

TELETYPE

Mr. Felt	_____
Mr. Bates	_____
Mr. Bishop	_____
Mr. Callahan	_____
Mr. Campbell	_____
Mr. Cleveland	_____
Mr. Conrad	_____
Mr. Dalbey	_____
Mr. Jenkins	_____
Mr. Marshall	_____
Mr. Miller, E.S.	_____
Mr. Ponder	_____
Mr. Soyars	_____
Mr. Walters	_____
Tele. Room	_____
Mr. Kinley	_____
Mr. Armstrong	_____
Ms. Herwig	_____
Mrs. Neenan	_____

NR 09 SD CODE

10:21 PM NITEL 7-19-72 GKF

TO ACTING DIRECTOR (100-451554)

FROM SAN DIEGO (157-2815) 1P

*G. E. Hooper  
SW*

*ren*

SECRET ARMY ORGANIZATION

EM-

*sw 32*

*R*

RE BUREAU LETTER TO ASSISTANT ATTORNEY GENERAL, INTERNAL SECURITY DIVISION, COPY TO SAC SAN DIEGO JULY FOURTEEN LAST.

FORMER SPECIAL AGENT STEVEN L. CHRISTENSEN DID NOT TESTIFY BEFORE THE SAN DIEGO, CALIFORNIA GRAND JURY AS HIS TESTIMONY WAS NOT NEEDED. HIS TESTIMONY MAY BE NEEDED FOR TRIAL PURPOSES LATER IN THE YEAR. SAN DIEGO WILL KEEP THE BUREAU ADVISED.

END

REG 44

~~157-23577-34X  
100-451554-114~~

JUL 21 1972

*5-Part 1 of 2*

MR. TRAINOR

DEC 21 1972

FBI

Date: 7/13/72

Photo Check  
CC TO Secret Service  
10/20/72  
BUG/ilm  
Re. Specific Request

Transmit the following in \_\_\_\_\_  
(Type in plaintext or code)

Via AIRTEL AIRMAIL - REGISTERED  
(Priority)

TO: ACTING DIRECTOR, FBI (157-23577)

FROM: SAC, SAN DIEGO (157-1820) (P)

*Tommy [unclear]*  
*ge*

WILLIAM FRANCIS YAKOPEC

EM - SAO

SECRET ADMINISTRATION

Re San Diego nitel to Bureau dated 6/27/72.

Enclosed for the Bureau are five (5) copies of an LHM concerning captioned matter.

INFORMANTS

Identity of Source

File Where Located

SD T-1 is [redacted]

SD 157-1820

SD T-2

See Nonsymbol Source Administrative Page

ADMINISTRATIVE

Two (2) copies of FD-376 are attached to the Bureau copies of this LHM.

A copy of this LHM is being disseminated to the U. S. Secret Service, San Diego, and one copy to Alcohol, Tobacco and Firearms Division, San Diego.

EX-114 REC-55 157-1820-34

This LHM is not being classified "Confidential" inasmuch as information being furnished does not meet the

- 2 Bureau (Encs. 5) (AM-RM)
- 2- San Diego
  - (1 - 157-1820)
  - (1 - 157-531)

7 JUL 17 1972

ENCLOSURE

ADH:can  
(4)

*W.C. [unclear]*  
FBI INT. SEC.

Approved: \_\_\_\_\_ Sent \_\_\_\_\_ M Per \_\_\_\_\_

SD 157-1820

criteria set forth in Executive Order 11652.

LEADS

SAN DIEGO

1. Will report results of FD-9 submitted to Bureau.
2. Will follow and report prosecution of subject.
3. An FD-356 has been resubmitted to St. Louis inasmuch as subject's service number has been ascertained. Will report military background when received.

BECAUSE OF YAKOPEC'S ACCESS TO AND USE OF FIREARMS AND EXPLOSIVES, HE SHOULD BE CONSIDERED ARMED AND DANGEROUS AND APPROACHED WITH CAUTION.

SD 157-1820

NONSYMBOL SOURCE ADMINISTRATIVE PAGE

SOURCE

SD T-2 is

**CONF. SOURCE**

Information located in SD 157-1820.



UNITED STATES DEPARTMENT OF JUSTICE  
FEDERAL BUREAU OF INVESTIGATION

July 13, 1972

WASHINGTON, D.C. 20535

In Reply, Please Refer to  
File No.

Director  
United States Secret Service  
Department of the Treasury  
Washington, D. C. 20220

RE: WILLIAM FRANCIS YAKOPEC

Dear Sir:

The information furnished herewith concerns an individual or organization believed to be covered by the agreement between the FBI and Secret Service concerning protective responsibilities, and to fall within the category or categories checked.

1.  Threats or actions against persons protected by Secret Service.
2.  Attempts or threats to redress grievances.
3.  Threatening or abusive statement about U. S. or foreign official.
4.  Participation in civil disturbances, anti-U. S. demonstrations or hostile incidents against foreign diplomatic establishments.
5.  Illegal bombing, bomb-making or other terrorist activity.
6.  Defector from U. S. or indicates desire to defect.
7.  Potentially dangerous because of background, emotional instability or activity in groups engaged in activities inimical to U. S.

Photograph  has been furnished  enclosed  is not available.

Very truly yours,

L. Patrick Gray, III  
Acting Director

1 - Special Agent in Charge (Enclosure(s)) - 2  
U. S. Secret Service, San Diego

Enclosure(s) - 2 (Upon removal of classified enclosures, if any, this transmittal form becomes UNCLASSIFIED.)



UNITED STATES DEPARTMENT OF JUSTICE

FEDERAL BUREAU OF INVESTIGATION  
San Diego, California

In Reply, Please Refer to  
File No.

July 13, 1972

MRS WILLIAM FRANCIS YAKOPEC

I. PREDICATION

Investigation in this matter is initiated upon receipt of information indicating the subject to have been active in the organization known as the Secret Army Organization (SAO).

The SAO is a para-military organization formed during the early part of October, 1971, by former members and supporters of the Minutemen Organization, for the purpose of replacing that organization, now considered defunct. With its headquarters located at San Diego, California, the SAO intends to work towards becoming a nationwide organization.

The Minutemen is a para-military group organized in June, 1960, by ROBERT B. DE PUGH in Norborne, Missouri, as a resistance to the spread of communism in the United States by use of guerrilla tactics. DE PUGH is currently incarcerated in a federal penitentiary for violation of the Federal Firearms Act.

II. BACKGROUND

DEBORAH YAKOPEC

A. Residence

Subject presently resides at 722 Graves Street, El Cajon, California.

(SD T-1, March 15, 1972)

This document contains neither recommendations nor conclusions of the FBI. It is the property of the FBI and is loaned to your agency; it and its contents are not to be distributed outside your agency.

157-22-77- 34

WILLIAM FRANCIS YAKOPEC

722 GRAVES ST.

B. Employment

EL CAJON, CALIF.

Subject is presently unemployed.

(SD T-1, March 15, 1972)

C. Education

BORN JAN. 10, 1942 - MILLER, IND.

The records of the Portage High School, provided by Mr. John Hevel, principal, reflected the following:

Subject attended Portage High School, Portage, Indiana, from September 4, 1956 to November 26, 1956, and from December, 1958 to January 9, 1959, when he left high school to enter the U. S. military service.

D. Military Service

Subject served in the U. S. Army from April 15, 1959 through March 14, 1962. Military occupational specialty -- Military Police; rank - Private First Class E-3. Subject received an Honorable Discharge.

(SD T-2, July 1, 1969)

E. Physical Description

On June 21, 1972, the California Law Enforcement Telecommunications System (CLETS) provided the following physical description of subject, effective March 10, 1970:

Race	Caucasian
Sex	Male
Height	5'8"
Weight	165
Hair	Brown
Eyes	Brown
Marital Status	Married
Social Security Account Number	

JFK Act 6 (3)

WILLIAM FRANCIS YAKOPEC

F. Marital Status

Subject is married. His spouse's name is Deborah.

(SD T-2, July 12, 1972)

G. Date and Place of Birth

Subject was born on January 10, 1942, at Miller, Indiana.

(SD T-2, July 1, 1969)

H. Employment Record

Subject served with the San Diego Police Department, without pay, in a reserve officer capacity, from September 16, 1969 through December 17, 1969. He was ostensibly released because of his poor credit rating. Yakopec actually was fired due to his involvement with the Minuteman organization. At the time of subject's reserve status with the San Diego Police Department, he was associated with the Council of Carpenters working as a carpenter. From October 16, 1967 through October 10, 1968, Yakopec was employed as an insurance agent for the Metropolitan Life Insurance Company, Santa Ana, California. Between January, 1965 and October, 1967, subject worked as a toolmaker for the Douglas Aircraft Company, Long Beach, California.

(SD T-2, July 1, 1969)

III. ACTIVITIES

On June 19, 1972, John Mansfield, San Diego Police Department, advised that an explosive device was detonated in the Guild Movie Theater, 3827 Fifth Avenue, San Diego, California, at 7:45 p.m., June 19, 1972, causing extensive damage.



WILLIAM FRANCIS YAKOPEC

On June 20, 1972, SD T-1 advised that subject had claimed responsibility for said bombing, describing the device involved as being a one-third pound HPD Primer Charge with six foot safety fuse, mechanical blasting cap and a pull time fuse lighter. Subject indicated he had placed this device by approaching the theater through an alley way removing the grate from an air vent and throwing the device through the vent beneath the stage of the theater.

Information concerning the bombing by subject was furnished to Detective Reuben Brandon, Investigative Support Unit (ISU), San Diego Police Department, on the date received.

On June 27, 1972, Detective Reuben Brandon advised that on the basis of information furnished by SD T-1 and based on the known involvement of subject in the Secret Army Organization (SAO) in the San Diego area, a warrant was secured and executed for a search of the subject's residence on June 26, 1972.

SAO and Minutemen literature dealing with explosives and construction of mines and booby traps were confiscated from subject's residence.

Yakopec was arrested for violations of Sections 12-303 and 12-303.2 of the California Penal Code (CPC) dealing with the possession and improper storage of gun powder in excess of twenty pounds without a license and violation of Section 217 CPC, charging him with attempted murder in connection with the bombing of the Guild Movie Theater.

William Francis Yakopec was indicted on July 12, 1972, after a true bill was returned by the San Diego County Grand Jury in and for the Superior Court of the State of California.

Yakopec was charged with Exploding Destructive Device with the Intent to Wrongfully Injure and Destroy Property and Injure Persons on said Property; five counts

WILLIAM FRANCIS YAKOPEC

of Attempted Murder in conjunction with said bombing; two counts of Assault with a Deadly Weapon by Means Likely to Cause Bodily Injury Upon Peace Officers; Possession of Explosives Near a Private Habitation.

Yakopec presently incarcerated in the San Diego County Jail. No trial date has yet been set. A hearing for the purpose of setting bail is to be held on July 13, 1972.

BECAUSE OF YAKOPEC'S ACCESS TO AND USE OF FIREARMS AND EXPLOSIVES, HE SHOULD BE CONSIDERED ARMED AND DANGEROUS AND APPROACHED WITH CAUTION.



UNITED STATES DEPARTMENT OF JUSTICE  
FEDERAL BUREAU OF INVESTIGATION  
San Diego, California

In Reply, Please Refer to  
File No.

July 13, 1972

Title WILLIAM FRANCIS YAKOPEC

Character

Reference Memorandum dated and captioned as  
above at San Diego.

All sources (except any listed below) whose identities  
are concealed in referenced communication have furnished reliable  
information in the past.

F B I

Date: 7/14/72

*Photo Copy  
Secret Service  
10/20/72*

Transmit the following in \_\_\_\_\_  
(Type in plaintext or code)

Via AIRTEL AIRMAIL \_\_\_\_\_  
(Priority)

REC-41  
BY: *BUC/ulm*

*Re: Specific Request  
Hlu*

TO: ACTING DIRECTOR, FBI (157-23577)

FROM: SAC, SAN DIEGO (157-2815) (P)

*Part of*

*Tom Howard*

SECRET ARMY ORGANIZATION (SAO)  
EXTREMIST MATTERS

Re San Diego teletype to Bureau 7/1/72 captioned  
"WILLIAM FRANCIS YAKOPEC, Bombing of Guild Theater, 3827 5th  
Avenue, San Diego, California, June 19, 1972, EID."

Enclosed for the Bureau are eleven copies of a  
letterhead memorandum.

Two copies of FD 376 are stapled to enclosed LHM.

SD T-1 is

Copies of the LHM are being disseminated locally  
to Alcohol Tobacco and Firearms Division, Secret Service,  
and Internal Revenue Service.

San Diego is following and will report activities  
of the SAO.

- ① - Bureau (Enc. 11) (RM)
- 3 - San Diego (2 - 157-2815)  
(1 157-3001)

ENCLOSURE

REC-41

33

7 JUL 17 1972

EMP:ejt  
(5)

*2-15D IRS, ATFD  
1-55, R/S  
7/19/72  
WCP/jim*

UNIFORM *W* CASE REPORTING

EXT. INT. SEC.

*W. E. [Signature]*

*4-destroyed*

Approved: \_\_\_\_\_ Sent \_\_\_\_\_ M Per \_\_\_\_\_



UNITED STATES DEPARTMENT OF JUSTICE  
FEDERAL BUREAU OF INVESTIGATION

WASHINGTON, D.C. 20535

July 14, 1972

In Reply, Please Refer to  
File No.

Director  
United States Secret Service  
Department of the Treasury  
Washington, D. C. 20220

RE: SECRET ARMY ORGANIZATION

Dear Sir:

The information furnished herewith concerns an individual or organization believed to be covered by the agreement between the FBI and Secret Service concerning protective responsibilities, and to fall within the category or categories checked.

1.  Threats or actions against persons protected by Secret Service.
2.  Attempts or threats to redress grievances.
3.  Threatening or abusive statement about U. S. or foreign official.
4.  Participation in civil disturbances, anti-U. S. demonstrations or hostile incidents against foreign diplomatic establishments.
5.  Illegal bombing, bomb-making or other terrorist activity.
6.  Defector from U. S. or indicates desire to defect.
7.  Potentially dangerous because of background, emotional instability or activity in groups engaged in activities inimical to U. S.

Photograph  has been furnished  enclosed.  is not available.

Very truly yours,

L. Patrick Gray, III  
Acting Director

1 - Special Agent in Charge (Enclosure(s)) 1  
U. S. Secret Service, San Diego

Enclosure(s) (Upon removal of classified enclosures, if any, this transmittal form becomes UNCLASSIFIED.)



UNITED STATES DEPARTMENT OF JUSTICE

FEDERAL BUREAU OF INVESTIGATION

In Reply, Please Refer to  
File No.

San Diego, California  
July 14, 1972

SECRET ARMY ORGANIZATION

At 8:03 PM on June 19, 1972, JOHN MANSFIELD, San Diego Police Department (SDPD) advised that an explosive device was detonated in the Guild Movie Theater at 3827 5th Avenue, San Diego, California, at 7:45 PM on that date, causing extensive damage to the theater.

On June 27, 1972, Detective RUBEN BRANDON, San Diego Police Department, advised that as a result of investigation into the explosion at the Guild Movie Theater, search warrants were served June 26, 1972, on the residences of WILLIAM FRANCIS YAKOPEC, 722 Graves Avenue, El Cajon, California; GEORGE MITCHELL HOOVER, 8721 Magnolia, Santee, California; and, RICHARD FLUERY, 1544 Harbison Canyon Road, San Diego, California.

YAKOPEC, HOOVER and FLUERY are known members of the Secret Army Organization (SAO).

(SD. T-1, June 27, 1972)

The SAO is a para-military ultra-conservative and militant organization in the San Diego area.

Detective BRANDON advised that after the search warrants were executed, YAKOPEC was arrested for violation of the California Penal Code (CPC) dealing with possession and improper storage of gun powder in excess of twenty pounds without a license and for attempted murder in connection with the bombing of the Guild Movie Theater. HOOVER was charged with

151-23577- 33

SECRET ARMY ORGANIZATION

violation of identical statutes. RICHARD FLUERY and his wife GENEVIEVE were arrested for violation of the CPC for improper storage of gun powder in excess of twenty pounds.

On June 30, 1972, JERRY LYNN DAVIS, National Leader of the SAO, stated that a member of the SAO had volunteered to take revenge for the arrest of SAO members in San Diego. He did not reveal the identity of the volunteer. His plan calls for the assassination of persons believed to be involved in the arrest of the SAO members. Individuals mentioned as targets for the assassin are Chief of Police RAYMOND HOUBLER, Inspector WILLIAM GORE and Detective RUBEN BRANDON, all of the San Diego Police Department; STEVE LOGAN, Bureau of Alcohol Tobacco and Firearms, and possibly the head of the Internal Revenue Service in San Diego, California. SAO members were instructed by DAVIS to gather intelligence information concerning home addresses and other information concerning persons picked as targets.

(SD T-1, July 1, 1972)

Sergeant JACK PEARSON, San Diego Police Department, LARRY CLENDENINE, Bureau of Alcohol Tobacco and Firearms, San Diego, JOHN KEEFE, U.S. Secret Service, San Diego, and Inspector RICHARD NELSON, Internal Revenue Service, Los Angeles, were advised July 1, 1972, of above information.

MEMBERS OF THE SAO SHOULD BE CONSIDERED ARMED AND DANGEROUS.

This document contains neither recommendations nor conclusions of the FBI. It is the property of the FBI and is loaned to your agency; it and its contents are not to be distributed outside your agency.



UNITED STATES DEPARTMENT OF JUSTICE  
FEDERAL BUREAU OF INVESTIGATION

In Reply, Please Refer to  
File No.

Title            SECRET ARMY ORGANIZATION

Character

Reference      Communication dated and  
captioned as above at San Diego,  
California.

All sources (except any listed below) whose identities  
are concealed in referenced communication have furnished reliable  
information in the past.



Assistant Attorney General  
Internal Security Division

July 14, 1972

Acting Director, FBI

- 1 - Mr. D. W. Dalbey
- 1 - Mr. H. N. Bassett
- 1 - Mr. W. C. Patterson

SECRET ARMY ORGANIZATION  
EXTREMIST MATTERS

This is to confirm that on July 12, 1972, Kevin T. Maroney, Deputy Assistant Attorney General, Internal Security Division, advised Special Agent William C. Patterson of this Bureau that authority was granted for former Special Agent Steven L. Christensen to testify before a San Diego, California, Grand Jury.

Testimony by former Special Agent Christensen is to be restricted to information he received while he was a Special Agent of the Federal Bureau of Investigation (FBI) from an informant regarding the shooting of Paula Tharp on January 6, 1972, by George M. Hoover, a member of the white extremist Secret Army Organization (SAO), and the June 19, 1972, bombing of a San Diego theater by William Francis Yakopec, also a member of the SAO. Should information be required in addition to the above, former Special Agent Christensen is to advise that in accordance with Code of Federal Regulations, Title 28, Section 16.12, such information acquired while in the performance of his official duties as a Special Agent of the FBI cannot be disclosed unless approved by the Attorney General. Additional information required is to be identified and furnished the Department in order that consideration can be given to whether such information is to be disclosed.

157-2815

2 - San Diego

MAILED 20  
JUL 14 1972  
FBI

REC-3 157-23579-32

SEE NOTE FOR SAC, SAN DIEGO,  
ON PAGE TWO  
JUL 17 1972

Felt \_\_\_\_\_  
Bates \_\_\_\_\_  
Bishop \_\_\_\_\_  
Callahan \_\_\_\_\_  
Campbell \_\_\_\_\_  
Cleveland \_\_\_\_\_  
Conrad \_\_\_\_\_  
Dalbey \_\_\_\_\_  
Jenkins \_\_\_\_\_  
Marshall \_\_\_\_\_  
Miller, E.S. \_\_\_\_\_  
Ponder \_\_\_\_\_  
Soyars \_\_\_\_\_  
Walters \_\_\_\_\_  
Tele. Room \_\_\_\_\_  
Mr. Kinley \_\_\_\_\_  
Mr. Armstrong \_\_\_\_\_  
Ms. Herwig \_\_\_\_\_  
Mrs. Neenan \_\_\_\_\_

1 - Personnel File of Steven L. Christensen

WCP:aso (9)

SEE NOTE PAGE TWO

MAIL ROOM  TELETYPE UNIT

Assistant Attorney General  
Internal Security Division

NOTE FOR SAC, SAN DIEGO:

ReSDtel 7/11/72 entitled "SD 1155-E."

This will confirm information furnished to ASAC Clark Brown by telephone on 7/12/72 by Bureau Supervisor William C. Patterson that authority had been granted by the Department for former Special Agent Steven L. Christensen to testify in San Diego, California, Grand Jury in accordance with the above.

NOTE:

Information regarding the above-described shooting and bombing was furnished the San Diego Police Department (SDPD) and persons involved are being prosecuted locally. [REDACTED] has been made available to the SDPD with regard to these matters. Recently, information was developed that [REDACTED] had furnished Special Agent Steven L. Christensen the pistol used in this shooting. This pistol had been obtained by the informant in a burglary. Special Agent Christensen made no record of the receipt of this pistol and retained it in his home and advised the Bureau the informant said "the gun had been disposed of." Special Agent Christensen acknowledged receipt of the gun and it has been turned over to the SDPD. Special Agent Christensen submitted his resignation effective 7/6/72.

Former Special Agent Christensen has been subpoenaed to testify before the San Diego, California, Grand Jury and the SAC, San Diego, recommended testimony of former Special Agent Christensen be restricted to information furnished him by the informant regarding the above incidents. This matter has been coordinated with Inspector John A. Mintz, Office of Legal Counsel.

FEDERAL BUREAU OF INVESTIGATION  
COMMUNICATIONS SECTION

JUN 28 1972

TELETYPE

Mr. Felt	_____
Mr. Mohr	_____
Mr. Rosen	_____
Mr. Bates	_____
Mr. Bishop	_____
Mr. Callahan	_____
Mr. Campbell	_____
Mr. Casper	_____
Mr. Cleveland	_____
Mr. Conrad	_____
Mr. Dalbey	_____ <i>SMX</i>
Mr. Marshall	_____ <i>SMX</i>
Mr. Miller, E.S.	_____ <i>SMX</i>
Mr. Ponder	_____ <i>SMX</i>
Mr. Soyars	_____ <i>SMX</i>
Mr. Walters	_____
Tele. Room	_____
Mr. Kinley	_____
Mr. Armstrong	_____
Ms. Herwig	_____
Mrs. Neenan	_____

NR 29 SD PLAIN

9:50PM NITEL 6-27-72 GKF

TO ACTING DIRECTOR (157-23577)

FROM SAN DIEGO (157-2815) (P) <sup>13</sup> (SP)

SECRET ARMY ORGANIZATION (SAO). EXTREMIST MATTERS.

RE SAN DIEGO TELETYPES TO BUREAU, JUNE NINETEEN,  
 TWENTYONE, TWENTY TWO, TWENTY THREE AND TWENTY SIX,  
 CAPTIONED "UNSUB; BOMBING OF GUILD MOVIE THEATRE,  
 THREE EIGHT TWO SEVEN DASH FIFTH AVENUE, SAN DIEGO,  
 CALIFORNIA, JUNE NINETEEN LAST, EID" AND SAN DIEGO  
 TELETYPE DATED JUNE TWENTYSEVEN INSTANT, CAPTIONED  
 "WILLIAM FRANCIS YAKOPEC, BOMBING OF GUILD MOVIE  
 THEATRE, THREE EIGHT TWO SEVEN DASH FIFTH AVENUE,  
 SAN DIEGO, CALIFORNIA, JUNE NINETEEN LAST, EID."

*Bo*

END PAGE ONE

REC-59  
EX-112

*157-23577-30*

JUN 5 1972

*267*

*5-4-72*

SD 157-2815

PAGE TWO

AT EIGHT: ZERO THREE PM, JUNE NINETEEN, SEVENTY TWO, JOHN MANSFIELD, SAN DIEGO, CALIFORNIA POLICE DEPARTMENT (SDPD), ADVISED THAT AN EXPLOSIVE DEVICE WAS DETONATED IN THE GUILD MOVIE THEATRE, THREE EIGHT TWO SEVEN DASH FIFTH AVENUE, SAN DIEGO, CALIFORNIA, ST SEVEN: FORTYFIVE PM, ON JUNE NINETEEN, SEVENTY TWO.

ON JUNE TWENTY, SEVENTY TWO, ~~REDACTED~~

ADVISED THAT ON THE MORNING OF THAT DATE, HE HAD RECEIVED A TELEPHONE CALL FROM WILLIAM FRANCIS YAKOPEC, SEVEN TWO TWO GRAVES STREET, EL CAJON, CALIFORNIA, ASKING HIM IF HE HAD READ AN ARTICLE IN THAT MORNING'S ISSUE OF THE SAN DIEGO DAILY NEWSPAPER THE "SAN DIEGO UNION" REGARDING THE BOMBING OF THE GUILD THEATRE. SOURCE INDICATED THAT HE HAD SEEN THE ARTICLE

END PAGE TWO

SD 157-2315

PAGE THREE

AT WHICH TIME, YAKOPEC HINTED HE WAS RESPONSIBLE FOR THE BOMBING. ON THAT SAME DATE, SOURCE CONTACTED YAKOPEC IN PERSON AT WHICH TIME, YAKOPEC CLAIMED RESPONSIBILITY FOR THE BOMBING AND DESCRIBED THE DEVICE INVOLVED AS BEING A ONE DASH THIRD POUND HPD PRIMER CHARGE WITH SIX FOOT SAFETY FUSE, MECHANICAL BLASTING CAP AND A PULL TIME FUSE LIGHTER. HE INDICATED HE HAD PLACED THIS DEVICE BY APPROACHING THE THEATRE THROUGH AN ALLEY WAY REMOVING THE GRATE FROM AN AIRVENT AND THROWING THE DEVICE THROUGH THE VENT BENEATH THE STAGE OF THE THEATRE.

YAKOPEC STATED HE THEN WALKED APPROXIMATELY ONE BLOCK AWAY FROM THE THEATRE AND WAITED FOR THE DEVICE TO DETONATE. YAKOPEC HAS PREVIOUSLY INDICATED TO THE SOURCE HIS DISTASTE FOR PORNOGRAPHIC ENTERTAINMENT.

END PAGE THREE

SD 157-2815

PAGE FOUR

YAKOPEC TOLD SOURCE HE CONSIDERED THE FILMS SHOWN BY THE GUILD THEATRE TO BE PORNOGRAPHIC AND INDICATED THAT HE HAD OTHER TARGETS.

YAKOPEC IS A MEMBER OF THE SECRET AMRY ORGANIZATION (SAO) IN SAN DIEGO, A RIGHT WING ACTIVIST GROUP. SOURCE INDICATED THAT THE BOMBING INCIDENT WAS AN INDIVIDUAL ACT ON THE PART OF YAKOPEC AND THAT OTHER MEMBERS OF SAO WERE NOT AWARE OF THE BOMBING.

INFORMATION CONCERNING THE BOMBING BY YAKOPEC WAS FURNISHED TO DETECTIVE REUBEN BRANDON, INVESTIGATIVE SUPPORT UNIT (ISU), SDPD, ON THE DATE RECEIVED.

AFTER LEAVING THE GUILD THEATRE, YAKOPEC WENT TO CHUCK'S BOOKSTORE CARRYING ANOTHER BOMB IN THE POCKET OF A JACKET SLUNG OVER HIS SHOULDER. HE TOLD SOURCE HE HAD INTENDED TO ALSO BOMB THE BOOKSTORE. AS HE ENTERED, AN SDPD OFFICER FLASHED HIS BADGED AND TOLD

END PAGE FOUR

SD 157-2815

PAGE FIVE

HIM HE COULD NOT ENTER AS THE BOOKSTORE WAS BEING CLOSED DOWN. YAKOPEC IMMEDIATELY LEFT THE AREA.

YAKOPEC TOLD SOURCE HE HAD "CASED" SEVERAL OTHER LOCATIONS IN THE SAN DIEGO METROPOLITAN AREA WHICH HE BELIEVES TO BE PLACES OF PORNOGRAPHIC ENTERTAINMENT. SOME OF THESE POSSIBLE FUTURE TARGETS ARE: "THE IN CROWD", A NIGHT CLUB<sup>B</sup> OFFERING NUDE ENTERTAINMENT IN SANTEE, CALIFORNIA; "THE ACADEMY THEATRE" ON UNIVERSITY AVENUE, SAN DIEGO; "THE PUSSYCATE THEATRE" ON FOURTH AVENUE, SAN DIEGO; "THE BEDROOM" ON UNIVERSITY AVENUE, SAN DIEGO.

YAKOPEC INDICATED THAT HE MIGHT ATTEMPT ANOTHER BOMBING IN THE NEXT FEW NIGHTS.

THE INFORMATION CONCERNING POSSIBLE FUTURE TARGETS WAS FURNISHED TO LT. ED STEVENS AND LT. REUBEN BRANDON, ISU, SDPD, ON JUNE TWENTY ONE LAST. THEY WERE ADVISED

END PAGE FIVE

SD 157-2815

PAGE SIX

THAT THE INFORMATION WAS FROM A CONFIDENTIAL SOURCE WHO HAD FURNISHED RELIABLE INFORMATION IN THE PAST. LT. STEVENS AND DETECTIVE BRANDON STATED THAT A SURVEILLANCE WAS BEING PLACE<sup>D</sup><sub>A</sub> ON YAKOPEC IN AN EFFORT TO PREVENT FUTURE BOMBINGS.

ON JUNE TWENTY TWO LAST, CHIEF OF THE SDPD RAYMOND HOOBLER ADVISED THAT HE IS GREATLY CONCERNED WITH THE ACTIVITIES OF YAKOPEC BECAUSE OF THE THREAT THAT HE PRESENTS TO THE WELFARE OF THE CITIZENS OF SAN DIEGO, PARTICULARLY INASMUCH AS HE HAS STATED TO INFORMANT THAT HE HAS FOUR OTHER TARGETS WHICH HE HAD UNDER CONSIDERATION FOR BOMBING AND HAS INDICATED AN INTENT TO CARRY OUT THESE BOMBINGS.

ON JUNE TWENTYTHREE LAST, ~~REDACTED~~ ADVISED THAT HE HAD BEEN CONTACTED BY YAKOPEC WHO

END PAGE SIX



SD 157-2815

PAGE SEVEN

STATED THAT HE HAD BEEN UNDER SURVEILLANCE FOR THE PAST TWO DAYS BY SOME POLICE AGENCY BUT THAT HE BELIEVED THAT THE SURVEILLANCE HAD BEEN DROPPED. HE STATED THAT HE HAD DECIDED TO BOMB "GENIES MASSAGE PARLOR," EL CAJON, CALIFORNIA, ON THE EVENING OF JUNE TWENTY THREE LAST, AND ASKED THE INFORMANT TO ACCOMPANY HIM. INFORMANT INDICATED TO YAKOPEC THAT HE MIGHT ACCOMPANY HIM IF HE WAS FREE THAT EVENING. INFORMANT WAS INSTRUCTED NOT TO ACCOMPANY YAKOPEC AND TO FURNISH HIM WITH A REASONABLE EXCUSE THAT HE COULD NOT BE CERTAIN THE SURVEILLANCE HAD BEEN DROPPED. INFORMATION CONCERNING THE BOMBING OF GENIES MASSAGE PARLOR WAS FURNISHED TO SGT. WHITT MURRAY, ISU, SDPD, THE OFFICER IN CHARGE OF THE SURVEILLANCE ON YAKOPEC. MURRAY STATED THAT YAKOPEC HAD FILED A COMPLAINT WITH THE EL CAJON POLICE

END PAGE SEVEN

SD 157-2815

PAGE EIGHT

DEPARTMENT CHARGING HARRASSMENT. LT. FREIDLAND, EL CAJON POLICE DEPARTMENT, COOPERATING WITH THE .SDPD ADVISED YAKOPEC THAT THE SURVEILLANCE MATTER INVOLVED A NARCOTICS MATTER IN THE NEIGHBORHOOD AND THE SURVEILLANCE WOULD BE CONTINUING.

YAKOPEC ADVISED SOURCE THAT IN VIEW OF THE SURVEILLANCE, HE WAS HOLDING THE BOMBING OF GENIES MESSAGE PARLOR IN ABEYANCE FOR THE TIME BEING.

ON JUNE TWENTY FIVE LAST, SOURCE ADVISED THAT YAKOPEC TOLD HIM THAT BECAUSE OF THE SURVEILLANCE, HE HAD DECIDED TO CONCEAL SOME EXPLOSIVES WHICH HE HAD IN HIS RESIDENCE AND HAD IN FACT CONCEALED THEM BENEATH A PILE OF SCRAP OF LUMBER LOCATED IN A VACANT LOT BEHIND HIS RESIDENCE. YAKOPEC LEFT SAN DIEGO ABOUT FOUR PM ON THE EVENING OF JUNE TWENTY FIVE LAST, TO VISIT RELATIVES IN LOS ANGELES, CALIFORNIA. SHORTLY

END PAGE EIGHT

SD 157-2815

PAGE NINE

FOLLOWING YAKOPEC'S DEPARTURE FOR LOS ANGELES, INFORMANT VERIFIED THE LOCATION OF THE EXPLOSIVES AND DETERMINED THAT THE STASH CONSISTED OF ONE, TWO AND ONE FOURTH POUNDS BLOCK OF C DASH FOUR MILITARY PLASTIC EXPLOSIVES; TWO, ONE POUND CANNISTERS OF DU PONT HPD PRIMER CHARGES; APPROXIMATELY THIRTY MECHANICAL CAPS IN A CANNISTER AND AN UNKNOWN QUANTITY OF SAFETY FUSE, BLACK IN COLOR; A TRIP LEVER FROM A KIT USED TO CONVERT AN M DASH ONE MILITARY CARBINE TO THE FULLY AUTOMATIC M DASH TWO VERSION WAS INCLUDED WITH THESE EXPLOSIVE DEVICES.

THIS INFORMATION WAS IMMEDIATELY FURNISHED TO SGT. JACK PEARSON, ISU, SDPD.

DURING THE EVENING OF JUNE TWENTY FIVE LAST, SGT. PEARSON, SUPRA, ADVISED A SEARCH HAD BEEN CONDUCTED BY OFFICERS OF THE SDPD IN THE VACANT LOT AND THE EXPLOSIVES

END PAGE NINE

SD 157-2315

PAGE TEN

AND THE TRIP LEVER LOCATED IN THE BROWN PAPER BAG BENEATH THE LUMBER PILE HAD BEEN CONFISCATED BY THE SDPD.

~~REDACTED~~ INDICATED A WILLINGNESS TO TESTIFY IN THIS MATTER IF TESTIMONY WAS REQUIRED TO SECURE PROSECUTIVE ACTION PROVIDED HE COULD BE ASSURED OF PROTECTION FOR HIMSELF AND HIS FAMILY, INCLUDING RELOCATION TO ANOTHER AREA IF NECESSARY. INFORMANT WAS MADE AVAILABLE ON JUNE TWENTY SIX LAST FOR INTERVIEW BY DETECTIVE REUBEN BRANDON, ISU, SDPD, IN THE PRESENCE OF SPECIAL AGENTS OF THE FBI AND HE WAS ADVISED BY BRANDON THAT THE SAN DIEGO CHIEF OF POLICE HAD AUTHORIZED HIM TO ASSURE THE INFORMANT THAT IF THE TESTIMONY BECAME NECESSARY, THE POLICE DEPARTMENT WOULD TAKE THE NECESSARY STEPS TO INSURE PROTECTION OF THE INFORMANT AND HIS FAMILY, TO RELOCATE THEM AND TO FIND SUITABLE EMPLOYMENT FOR THE INFORMANT.

END PAGE TEN

SD 157-2815.

<sup>E</sup>  
PAGE ELEVIN

ON JUNE TWENTY SEVEN INSTANT, DETECTIVE REUBEN BRANDON, SUPRA, ADVISED THAT ON THE BASIS OF INFORMATION FURNISHED BY [REDACTED] AND BASED ON THE KNOWN INVOLVEMENT OF YAKOPEC IN THE SAO IN THE SAN DIEGO AREA, WARRANTS WERE SECURE<sup>D</sup> ON THE EVENING OF JUNE TWENTY SIX LAST FOR SEARCHES OF THE RESIDENCES OF YAKOPEC AT SEVEN TWO TWO GRAVES AVENUE, EL CAJON, CALIFORNIA, AND OF KNOWN SAO MEMBERS GEORGE MITCHELL HOOVER, EIGHT SEVEN TWO ONE MAGNOLIA, SANTEE, CALIFORNIA, AND RICHARD FLEURY, ONE FIVE FOUR FOUR HARBISON CANYON ROAD, SAN DIEGO, CALIFORNIA. THE SEARCH WARRANTS WERE EXECUTED ON THE EVENING OF JUNE TWENTY SIX LAST.

LARGE QUANTITIES OF SAO AND MINUTEMEN LITERATURE DEALING WITH EXPLOSIVES AND CONSTRUCTION OF MINES AND BOOBY TRAPS WERE CONFISCATED FROM YAKOPEC'S RESIDENCE.

END PAGE ELEVEN

SD 157-2815

PAGE TWELVE

A TOTAL OF FOURTEEN ASSORTED WEAPONS WERE SEIZED AT THE RESIDENCES OF HOOVER AND FLEURY, INCLUDING NINE MM AUTOMATIC PISTOL, A TWENTY TWO MAGNUM DERRINGER AND ASSORTED RIFLES, SHOTGUNS AND PISTOLS AS WELL AS SEVERAL THOUSAND ROUNDS OF ASSORTED AMMUNITIONS FOR THE WEAPONS. APPROXIMATELY FIFTY POUNDS OF GUN POWDER WAS SEIZED AT FLEURY'S RESIDENCE.

YAKOPEC WAS ARRESTED FOR VIOLATIONS OF SECTIONS TWELVE DASH THREE ZERO THREE AND TWELVE DASH THREE ZERO THREE POINT TWO OF THE CALIFORNIA PENAL CODE (CPC) DEALING WITH THE POSSESSION AND IMPROPER STORAGE OF GUN POWDER IN EXCESS OF TWENTY POUNDS WITHOUT A LICENSE AND VIOLATION OF SECTION TWO ONE SEVEN CPC, CHARGING HIM WITH ATTEMPTED MURDER IN CONNECTION WITH THE BOMBING OF THE GUILD MOVIE THEATRE. HOOVER WAS CHARGED WITH VIOLATION OF THE IDENTICAL STATUTES. FLEURY AND HIS WIFE GENEVIEVE

END PAGE TWELVE

SD 157-2815

PAGE THIRTEEN

WERE CHARGED WITH VIOLATION OF SECTION TWELVE DAS<sup>H</sup> THREE  
ZERO THREE POINT TWO (B), IMPROPER STORAGE OF GUN POWDER  
IN EXCESS OF TWENTY POUNDS, A VIOLATION OF THE CALIFORNIA  
HEALTH AND SAFETY CODE. YAKOPEC, HOOVER, AND MR. AND  
MRS. FLEURY ARE CURRENTLY INCARCERATED IN THE SAN DIEGO  
COUNTY JAIL.

DETECTIVE BRANDON STATED THAT THE CHARGE OF VIOLATION  
OF SECTION TWO ONE SEVEN CPC WAS BROUGHT AGAINST HOOVER IN AN  
EFFORT TO FURTHER PROTECT THE IDENTITY OF   
 HE ANTICIPATES THAT THIS CHARGE WILL LATER  
BE DROPPED.

LHM FOLLOWS.

END

UNITED STATES GOVERNMENT

# Memorandum

TO : Mr. E. S. Miller

FROM : G. C. Moore *GEM*

SUBJECT: SECRET ARMY ORGANIZATION  
EXTREMIST MATTERS

- 1 - Mr. S. B. Donahoe
- 1 - Mr. E. S. Miller
- 1 - Mr. A. W. Gray
- DATE: 6/28/72
- 1 - Mr. G. C. Moore
- 1 - Mr. R. L. Ridgeway
- 1 - Mr. W. C. Patterson

- Felt \_\_\_\_\_
- Mohr \_\_\_\_\_
- Rosen \_\_\_\_\_
- Bates \_\_\_\_\_
- Bishop \_\_\_\_\_
- Callahan \_\_\_\_\_
- Campbell \_\_\_\_\_
- Casper \_\_\_\_\_
- Cleveland \_\_\_\_\_
- Conrad \_\_\_\_\_
- Dalbey \_\_\_\_\_
- Marshall \_\_\_\_\_
- Miller, E.S. \_\_\_\_\_
- Ponder \_\_\_\_\_
- Soyars \_\_\_\_\_
- Walters \_\_\_\_\_
- Tele. Room \_\_\_\_\_
- Mr. Kinley \_\_\_\_\_
- Mr. Armstrong \_\_\_\_\_
- Ms. Herwig \_\_\_\_\_
- Mrs. Neenan \_\_\_\_\_

*J. E. [Signature]*

Purpose of this memorandum is to advise that a San Diego Division extremist informant furnished information resulting in the solution of a bombing perpetrated by a member of the Secret Army Organization (SAO), a white ultraconservative, paramilitary group clandestinely formed in Arizona in 1971, and the confiscation of explosives.

On 6/20/72, ~~\_\_\_\_\_~~ advised that William Francis Yakopec, a member of the SAO, El Cajon, California, said he personally, *Bo* without the knowledge of other SAO members, was responsible for the 6/19/72 bombing of the Guild, a movie theater specializing in pornographic films, 3827 Fifth Avenue, San Diego, and he identified four pornography-oriented establishments as potential future bombing targets. This information was furnished to the San Diego Police Department (SDPD).

On 6/25/72, Yakopec told the informant the location of explosives he had concealed in a vacant lot behind his residence. This information was also furnished to the SDPD and a search of the lot resulted in the confiscation of one two-and-one-quarter-pound block of C-4 military plastic explosives, two one-pound canisters of primer charges, approximately 30 mechanical caps, and an unknown quantity of safety fuses.

EX-112 REC-59

*157-13577-315 H [Signature]*

On 6/26/72, based on information furnished by the source and Yakopec's known involvement in SAO activity, the SDPD executed search warrants at the home of Yakopec and SAO members George Mitchell Hoover and Richard Fleury. The searches produced large quantities of SAO and Minutemen literature dealing with explosives and the construction of mines and booby traps, 14 weapons, several thousand rounds of ammunition, and approximately 50 pounds of gunpowder.

RWH:aso (7) *[Handwritten marks]*

CONTINUED - OVER



Memorandum to Mr. E. S. Miller  
Re: Secret Army Organization

Yakopec and Hoover were arrested and charged with attempted murder and improper storage of gunpowder in excess of 20 pounds without a license. Fleury and his wife, Genevieve, were arrested and charged with improper storage of gunpowder in excess of 20 pounds. All four subjects are currently incarcerated in the San Diego County Jail.

The source has expressed willingness to testify in this matter if necessary to secure prosecutive action. The SDPD has stated should the source's testimony become necessary steps would be taken by that Department to insure protection of the source and his family and that they would be relocated and suitable employment obtained for the source.

Inasmuch as the preliminary facts regarding the bombing of the Guild Theater failed to indicate involvement of members of a terrorist or revolutionary group, under existing guidelines the incident was one within the primary jurisdiction of the Alcohol, Tobacco and Firearms Division and that agency was immediately advised.

Pertinent portions of this information will be furnished to the Internal Security Division of the Department of Justice and to Secret Service.

ACTION:

For information.

RW/7 AET  
DEM./HJD

EM/DEM AG  
WGC

JA

San Diego, California  
June 19, 1972

San Diego File: 157-2815  
Bufile: 157-23577

BRIEF DESCRIPTIVE CHARACTERIZATION

SECRET ARMY ORGANIZATION (SAO)

*gws*

The Secret Army Organization (SAO) is a para-military organization formed in 1971, at San Diego, California, by former members and supporters of the Minutemen Organization.

*157-23577*

NOT RECORDED

12 JUN 22 1972

*id*

Source:                     

AUG 2 1972

Ext. INT. [Signature]

San Diego, California  
June 19, 1972

San Diego File: 157-2815  
Bufile: 157-23577

APPENDIX

SECRET ARMY ORGANIZATION (SAO)

The Secret Army Organization (SAO) is a para-military organization formed during the early part of October, 1971, at San Diego, California, by former members and supporters of the Minutemen Organization, for the purpose of replacing that organization, now considered defunct in San Diego, California. With its headquarters located at San Diego, California, the SAO intends to work toward becoming a nation-wide organization.

*Handwritten initials: JWS*

*Handwritten notes: see p. 50, WEP: 050, 7/25/72*

*Handwritten initials: ed*

APPENDIX

Source:                       
June 14, 1972

157-23577-

NOT RECORDED  
12 JUN 22 1972

*Handwritten initials: WEP*

*Handwritten: F.30\**

F B I

Date: 6/16/72

Transmit the following in \_\_\_\_\_  
(Type in plaintext or code)

Via AIRTEL \_\_\_\_\_  
(Priority)

TO: BUREAU (157-23577)  
FROM: SAC, SAN DIEGO (157-2815)(P)  
SECRET ARMY ORGANIZATION (SAO)  
EXTREMIST MATTERS

*Handwritten:* 2 copies per 169

Re Bureau and San Diego teletypes on 4/25/72, and 4/28/72, respectively, both captioned "JERRY LYNN DAVIS, EXTREMIST MATTERS - SECRET ARMY ORGANIZATION"; "SECRET ARMY ORGANIZATION, EXTREMIST MATTERS".

Enclosed for the Bureau are eight copies of an LHM dated and captioned as above.

Source utilized in LHM is \_\_\_\_\_

*Handwritten:* T. Peter

Agents who conducted investigation set forth in the LHM are SAs STEVEN L. CHRISTENSEN and EARL M. PETERSEN.

Two copies of an FD-376 are stapled hereto. Copies of the LHM have been disseminated locally to U. S. Secret Service and Alcohol, Tobacco and Firearms Division (ATFD) in view of their interest in these matters.

Active investigation has been initiated on RICHARD MILLER. CY ANDERSON's activities are currently under investigation by the Seattle Division.

The pretext referred to in the LHM which was used for gaining access to the Gunsmoke Ranch, was that the Agents were seeking directions to the Deer Park Lodge.

LEAD

Will continue to follow activities of the SAO.

*Stamp:* EX 151

*Stamp:* REC-9 157-23577-29

- ② - Bureau (Enc - 8)
- 2 - San Diego
- SLC:sif
- (4)

*Stamp:* ENCLOSURE

JUN 22 1972

*Stamp:* EXT. SEC.



UNITED STATES DEPARTMENT OF JUSTICE  
FEDERAL BUREAU OF INVESTIGATION

June 16, 1972

WASHINGTON, D.C. 20535

In Reply, Please Refer to  
File No.

Director

United States Secret Service  
Department of the Treasury  
Washington, D. C. 20220

RE:

SECRET ARMY ORGANIZATION (SAO)  
EXTREMIST MATTERS

Dear Sir:

The information furnished herewith concerns an individual or organization believed to be covered by the agreement between the FBI and Secret Service concerning protective responsibilities, and to fall within the category or categories checked.

1.  Threats or actions against persons protected by Secret Service.
2.  Attempts or threats to redress grievances.
3.  Threatening or abusive statement about U. S. or foreign official.
4.  Participation in civil disturbances, anti-U. S. demonstrations or hostile incidents against foreign diplomatic establishments.
5.  Illegal bombing, bomb-making or other terrorist activity.
6.  Defector from U. S. or indicates desire to defect.
7.  Potentially dangerous because of background, emotional instability or activity in groups engaged in activities inimical to U. S.

Photograph  has been furnished  enclosed  is not available.

Very truly yours,

L. Patrick Gray, III  
Acting Director

1 - Special Agent in Charge (Enclosure(s)) 1  
U. S. Secret Service, San Diego

Enclosure(s) - 1 (Upon removal of classified enclosures, if any, this transmittal form becomes UNCLASSIFIED.)



UNITED STATES DEPARTMENT OF JUSTICE

FEDERAL BUREAU OF INVESTIGATION  
San Diego, California  
June 16, 1972

In Reply, Please Refer to  
File No. 157-2815

SECRET ARMY ORGANIZATION

On April 26, 1972, a confidential source, who has provided reliable information on numerous occasions in the past, advised no recent developments have been made in plans by Jerry Lynn Davis and the Secret Army Organization (SAO) for disruptions during the Republican National Convention (RNC). The source explained that due to the time interval until the advent of the RNC, such plans had only reached a speculation or discussion stage. Furthermore, actual plans and activities by the SAO would depend greatly on the nature of conditions existing during the RNC i.e., number of New Left demonstrators, riots, police retaliation, etc.

The Secret Army Organization (SAO) is a para-military organization formed during the early part of October, 1971, by former members and supporters of the Minutemen Organization, for the purpose of replacing that organization, now considered defunct. With its headquarters located at San Diego, California, the SAO intends to work towards becoming a nationwide organization. Jerry Lynn Davis, 2393 Washington, Spring Valley, California, is the leader of SAO in the San Diego area.

*JERRY L. DAVIS*  
The Minutemen Organization is a para-military group organized in June, 1960, by Robert B. DePugh in Norborne, Missouri, as a resistance to the spread of communism in the United States by use of guerrilla tactics. DePugh is currently incarcerated in a Federal penitentiary for violation of the Federal Firearms Act. The Patriotic Party has been the political arm of the Minutemen.

The source had previously received information to the effect that four cannons of a type similar to those used in the Civil War might be available for use by Davis and his associates. On April 26, 1972, the source stated that two of these are maintained in the front yard of the Gunsmoke Ranch, 1509 Harbison Canyon Road in San Diego County area. This ranch is owned by Alden Edward Willis, not a member of the SAO, however, he is *ALIF* politically sympathetic and friendly with Davis. The source is not sure how readily available these weapons might now be to the SAO. A third cannon, previously referred to as being under construction, is now complete and is located in the backyard of SAO member Stanley Don McDade, 3220 Sweetwater Road, Lemon Grove, California.

157-2815-29

SECRET ARMY ORGANIZATION

The source advised he was only told of the existence of the fourth cannon and does not know its owner or location. The source said he understands these weapons are legal under both State and Federal law.

The source stated to his knowledge, Davis is not presently manufacturing or selling firearms or explosives in violation of Federal or California law. The source advised that approximately six months ago he observed Davis in possession of a fully automatic AR 18 rifle in .223 caliber which was received earlier the same day by Davis from one Richard Miller, 7186 Glenroy, San Diego. Miller's source of the AR 18 is not known but source said it is rumored that he has contact with a stockholder of the manufacturer, Armalite Company, and has also had AR 180 rifles (legal civilian version of the AR 18 rifle) for sale when no one else could get them. CALIF.

Davis showed the source that the safety lever on his AR 18 had the third position for fully automatic fire. The source could not obtain the serial number.

On or about March 20, 1972, the source observed Davis take delivery of a fully automatic M-2 carbine in .30 caliber from Cy Anderson, 1948 Northeast 168 Place, Bothell, Washington, who is known to source as a trafficker in firearms and other items of questionable legality. The source observed the fully automatic fire control lever on the weapon but was not in a position to obtain its serial number. The source advised he is sure Davis still possesses the AR 18 rifle but Davis claims this weapon is now "stashed" and its location is not known to the source. The source said Davis maintains the M-2 carbine in his bedroom at his residence, 2393 Washington Street, Spring Valley, California; however, Davis has assured the source that certain parts have been removed from both rifles so as to cause them to fire semi-automatic only.

On September 28, 1971, Davis was observed by source in possession of about two blocks of C-4 plastic explosives weighing two and one quarter pounds each, about four pounds of TNT in one half and one pound blocks, and about two pounds of HPD primers in one third pound blocks. The source knows of no legal basis for the possession of these items by Davis. The source advised these items were last known by him to be located at the residence of SAO member George Mitchell Hoover, 8721 Magnolia, Santee, California, and were seen there by the source as late as

SECRET ARMY ORGANIZATION

approximately the first of April, 1972.

On April 27, 1972, Special Agents of the FBI at San Diego, using a suitable pretext, observed two Civil War style cannons on the premises of the Gunsmoke Ranch. One cannon, obviously hand made or home made, had a barrel approximately two feet in length with about a two inch bore and was mounted on a small four wheel carriage of an old Navy style. The second cannon appeared to be an original Civil War piece with about a three foot barrel having about a three inch bore.

A third cannon was observed by these Special Agents the same day in the backyard of the McDade residence by driving up a driveway commonly shared by three houses. This gun had a barrel of approximately four feet with close to a four inch bore and was mounted on a home made two wheel carriage.

On April 28, 1972, Donald Grossmeyer, Special Investigator, Alcohol, Tobacco and Firearms Department (ATFD), San Diego, advised neither he nor his office had any knowledge regarding Richard Miller or his activities. Grossmeyer stated that the three cannons are legal under Federal law but thought they might possibly have to be registered to be legal under California law.

On May 26, 1972, Special Agent James Berrian, California Bureau of Criminal Investigation and Identification, San Diego, made available copies of records maintained by his Bureau, pertaining to transactions involving sales of handguns by individuals using the name Jerry L. Davis or Jerry Lynn Davis. In excess of twenty such transactions were found which were identifiable with Davis. In no two of these transactions was the second party to the sale the same individual. Special Agent Berrian pointed out that due to the dates involved, many of these weapons would appear to have been resold by Davis.

On June 7, 1972, the first source advised that with the RNC having been changed to Miami, Florida, the activities of the SAO had entered into a relatively quiet period and that the organization would at least temporarily concentrate on recruitment and propagandizing. He stated he had not yet been able to determine the location of any illegal explosives or weapons.

This document contains neither recommendations nor conclusions of the FBI. It is the property of the FBI and is loaned to your agency; it and its contents are not to be distributed outside your agency.



UNITED STATES GOVERNMENT

# Memorandum

TO : ACTING DIRECTOR, FBI (157-23577)

DATE: 6/16/72

FROM : SAC, PHOENIX (157-1173) (P)

SUBJECT: SECRET ARMY ORGANIZATION (SAO)  
EXTREMIST MATTERS

*FILED  
R. J. [unclear]*

*ml*

RePXlet, 5/31/72, and Bulet, 6/12/72, captioned

As pointed out in referenced Phoenix letter, the SAO does not have any members in Arizona at this time. Informant states that he has received only six applications and that their identities do not check out.

**PROTECT INFORMANT AND POLICE  
UNDERCOVER OPERATION**

ARIZ.

ARIZ.

2 - Bureau (RM)  
2 - Phoenix (157-1173)  
(1 - 157-1242)

CLC:lmb  
(4)

REC-58  
EX-112  
157-23577-28

JUN 20 1972

EXT. INT. SEC.



JUN 28 1972

UNITED STATES GOVERNMENT

# Memorandum

TO : ACTING DIRECTOR, FBI (157-23577)

DATE: 6/15/72

FROM : SAC, SEATTLE (157-1830) (P)

SUBJECT: SECRET ARMY ORGANIZATION (SAO)  
EXTREMIST MATTERS  
OO: San Diego

CYRIL SUMNER ANDERSON  
EM - SAO  
OO: Seattle

Reference Seattle letter to the Bureau dated 5/17/72 captioned "Secret Army Organization" and San Diego airtel to the Bureau captioned "Secret Army Organization" dated 4/11/72.

Enclosed for the Bureau are six (6) copies of an LHM pertaining to captioned matter.

The confidential informant, SE T-1, is ~~located~~ located in Seattle file 157-1830-7.

This LHM is being classified CONFIDENTIAL because unauthorized disclosure of information furnished by SE T-1 could reasonably result in identifying a confidential source of continuing value and possibly adversely affect the defense interests of the nation.

Investigation in Seattle has determined that the FNU BAGWELL as mentioned in San Diego airtel to the Bureau dated 4/11/72, is apparently HUGHES ANDERSON-BAGLEY, JR. Seattle is currently conducting investigation to obtain current information concerning BAGLEY and, if warranted, an LHM will be submitted if investigation so indicates. Otherwise, after obtaining of pertinent background and activities, the matter on BAGLEY will be closed administratively in Seattle. The information in the referenced airtel indicates solely that BAGLEY was allegedly a member of the SAO in Seattle.

- ② - Bureau (Enc. 6)
- 2 - San Diego (Enc. 2) (157-2815)
- 3 - Seattle
  - (2 - 157-1830)
  - (1 - 157-1867) (CY ANDERSON)

ENCLOSURE (REG)

ST-115 REC-8

157-23577- )

ACT-38

JUN 19 1972

EX-103

CSER/Jul 13 1972 2cc-LSO  
(7) 1cc-SS  
1cc-IRS

EXT. INT. SEC. 157-1830-7

unique copy and copy of encl filed in 157-1830-7

SE 157-1830

The following sources have been contacted as indicated below, and none of them have furnished information indicating an active SAO in the Seattle Division. These sources have previously furnished reliable information concerning Minuteman activities:

<u>SOURCE</u>	<u>DATE CONTACTED</u>	<u>AGENT</u>
[REDACTED]	2/24/72 and 5/22/72	LOUIS M. HARRIS, JR.
[REDACTED]	2/24/72 and 5/22/72	LOUIS M. HARRIS, JR.

The Seattle Office is pursuing investigation concerning ANDERSON and the SAO to determine if, in fact, the SAO is a functioning organization in the Seattle Division.

Investigation will be conducted on ANDERSON's associates only upon receipt of pertinent information that they are associated with the SAO.

LEADS

SEATTLE  
At Seattle, Washington

Will direct former [REDACTED] and [REDACTED] to attempt to gain positive information directly through ANDERSON or other logical means to determine if the SAO exists in the Seattle Division.



CONFIDENTIAL

UNITED STATES DEPARTMENT OF JUSTICE

FEDERAL BUREAU OF INVESTIGATION

Seattle, Washington

June 15, 1972

In Reply, Please Refer to  
File No.

RE: SECRET ARMY ORGANIZATION  
(SAO)

CYRIL SUMNER ANDERSON

Secret Army Organization (SAO)

On May 5, 1971, this source advised that the Secret Army Organization was a new right wing group which was to organize individuals in various localities with the provision of military-type training for the purpose of being ready to eventually take over political power in the United States when the present Government fails due to oppression or communist influence.

SE T-1

On December 20, 1971, this source stated that although the SAO is a fairly new organization with a new name, it would continue to adhere to the tenets and principles of the old Minuteman Organization.

SE T-1

This document contains neither recommendations nor conclusions of the FBI. It is the property of the FBI and is loaned to your agency; it and its contents are not to be distributed outside your agency.

CONFIDENTIAL

GROUP 1

Excluded from automatic  
downgrading and  
declassification

ENCLOSURE 157-23577 27

CONFIDENTIAL

RE: SECRET ARMY ORGANIZATION

CYRIL SUMNER ANDERSON

The Minutemen is a paramilitant group organized in June, 1960, by Robert B. DePugh in Norborne, Missouri, as a resistance to the spread of communism in the United States by use of guerrilla tactics. DePugh is currently incarcerated in a Federal penitentiary for violation of the Federal Firearms Act.

The Patriotic Party has been the political arm of the Minutemen.

On January 6, 1972, this source advised that his office had no information concerning the Secret Army Organization.

Special Investigator  
DONALD MADSON  
Alcohol, Tobacco and  
Firearms Division,  
Seattle, Washington

On February 14, 15 and 16, 1972 the records of the Seattle Police Department, King County Sheriff's Office and police agencies in smaller communities in the Metropolitan Seattle area were examined and there was no information concerning the SAO in these departments.

On February 24, 1972, sources in the Seattle Division who have furnished reliable information in the past concerning Minutemen activities were contacted, none of whom were able to furnish any information concerning the Secret Army Organization. These sources were recontacted during May, 1972, and they were still unable to furnish any information concerning the existence of the SAO.

CYRIL SUMNER ANDERSON

On January 7, 1972, this source advised that CY ANDERSON, residing at 10418 Northeast 168th Place,

CONFIDENTIAL

CONFIDENTIAL

RE: SECRET ARMY ORGANIZATION

CYRIL SUMNER ANDERSON

Bothell, Washington, was "captain"  
within the Secret Army Organization.

SE T-1

On January 6, 1972, this source advised that his office had no information concerning CYRIL ANDERSON being involved with the SAO.

Special Investigator  
DONALD MADSON  
Alcohol, Tobacco and  
Firearms Division,  
Seattle, Washington

On February 14, 15 and 16, 1972 the records of the Seattle Police Department, King County Sheriff's Office and police agencies in smaller communities in the Metropolitan Seattle area were examined and there was no information of CYRIL ANDERSON being involved with the SAO.

On February 24, 1972, sources in the Seattle Division who have furnished reliable information in the past concerning Minutemen activities were contacted, none of whom were able to furnish any information concerning CY ANDERSON being involved with the SAO. These sources were recontacted during May, 1972, and they still had no knowledge of CY ANDERSON being involved with the SAO.

On February 17, 1972, the records of the Seattle Credit Bureau contained the following information concerning CYRIL SUMNER ANDERSON, also known as CY ANDERSON:

Address	10418 Northeast 168th Place Bothell, Washington
Wife	DEONNA HELEN SUITER (nee)
Height	6'1"
Weight	230 pounds
Eyes	Blue
Date of Birth	October 5, 1941
Social Security Account Number	

JFK Act 6 (3)

- 3 -

CONFIDENTIAL

CONFIDENTIAL

RE: SECRET ARMY ORGANIZATION

CYRIL SUMNER ANDERSON

Current Employment

Owner of AAA Enterprises  
Bothell, Washington

Former Employments

July, 1970  
Northwest Outfitters  
Position: partner

June, 1968  
Self-employed with the  
Pacific Ordinance Wholesale

Former Addresses

April, 1967  
Hilton Gun Shop  
Seattle, Washington  
April, 1967  
10040 Northeast 145th  
Bothell, Washington

October, 1964  
10712 Northeast 168th Place  
Bothell, Washington

On May 17, 1972, Sergeant R. J. PLANCICH, Bothell Police Department, Bothell, Washington, advised that he has no knowledge of the Secret Army Organization, but knows CY ANDERSON to have resided in the Bothell, Washington area for several years and considers CY ANDERSON a "gun nut" and "gunsmith." PLANCICH stated that he has had personal contact with ANDERSON over the years and knew him when he was a gun dealer in the Metropolitan Seattle area. PLANCICH stated that he knows of no specific criminal activities on the part of ANDERSON other than possible dealings in illegal weapons which PLANCICH stated is a possibility with anyone who is a gunsmith in the current days, referring to the present gun laws.

PLANCICH stated that his files previously had information of miscellaneous reports concerning ANDERSON's activities in the purchasing and selling of various type short and long barreled weapons. PLANCICH stated that the only information that would indicate any right wing activities on the part of ANDERSON were incidents that occurred during the summer of 1969 when his office received information that ANDERSON, accompanied by other white males were seen in the woods in

RE: SECRET ARMY ORGANIZATION

CYRIL SUMNER ANDERSON

the Bothell, Washington area carrying sidearms and wearing camouflage clothing. When investigated by his department, it was determined that at that time ANDERSON was involved in what was referred to as "simulated maneuvers" in the woods around the Bothell, Washington area which PLANCICH described as being heavily populated by farms and related businesses. Also during the summer of 1969, a Bothell Police Officer observed ANDERSON in the company of several other white males who were once again conducting some sort of maneuvers. At this time the officer observed a shotgun in one of the vehicles, which when measured was just 1/2 inch over the legal limit. During the early fall of 1969, ANDERSON approached an officer of the Bothell Police Department with a weapon to determine if it was legal and under the current interpretations of both Federal and state law, it was opined that the weapon ANDERSON had was legal, but no record was maintained as to the type of weapon.

PLANCICH stated that ANDERSON, in the past, has purchased old Bothell Police Department vehicles and it was PLANCICH's opinion that ANDERSON did this to satisfy some unknown egomania that he felt ANDERSON had. PLANCICH stated that he knew of no violent acts committed by ANDERSON at any time.

PLANCICH stated that the only close friends and acquaintances that he knows of ANDERSON's are as follows:

GEORGE LOSEY,  
Woodinville, Washington

W. H. (BILL) MacONAGHIE,  
3813 Northeast 123rd Street  
Seattle, Washington  
Date of Birth 5/21/42

ROBERT VERSTRATE  
1863 - 15th Avenue Northeast  
Seattle, Washington  
Date of Birth: 7/18/42.





UNITED STATES DEPARTMENT OF JUSTICE  
FEDERAL BUREAU OF INVESTIGATION

Seattle, Washington  
June 15, 1972

In Reply, Please Refer to  
File No.

Title           SECRET ARMY ORGANIZATION (SAO)  
                  CYRIL SUMNER ANDERSON

Character

Reference       Communication at Seattle, Washington,  
                  dated and captioned as above.

All sources (except any listed below) whose identities are concealed in referenced communication have furnished reliable information in the past.

This document contains neither recommendations nor conclusions of the FBI. It is the property of the FBI and is loaned to your agency; it and its contents are not to be distributed outside your agency.

UNITED STATES GOVERNMENT

# Memorandum

REC-68

1, 2

TO : ACTING DIRECTOR, FBI (157-23577)

DATE: 5/31/72

FROM : SAC, PHOENIX (157-1173) (P)

SUBJECT: SECRET ARMY ORGANIZATION (SAO)  
EXTREMIST MATTERS

ReBuairtel, 4/18/72; PXairtel, 4/27/72.

There are enclosed to the Bureau herewith six copies of an LHM pertaining to captioned matter.

## PROTECT INFORMANT

the SAO is proceeding cautiously in Arizona in order not to assimilate any eccentric people who could redound to the discredit of the SAO in terms of being a patriotic organization.

## INFO TENDS TO IDENTIFY INFORMANT

DANIEL MICHAEL TOPOROSKI, 615 West Alturas, Tucson, Arizona;

HOWARD ALLEN, Box 542, Phoenix, Arizona;

- 2 - Bureau (Encl.-6) (RM)
  - 2 - San Diego (Encl.-2) (RM)
  - 3 - Phoenix
- CLC:lmb  
(16)

ENCLOSURE  
REC 68 157-23577-26  
2 cc ~~IEC~~ IEC (DEPT)  
1 cc - SS  
JUN 2 1972

By Bu R/S

RPF/wel

EXHIBIT SEC.

REC-68  
157-23577-26

Handwritten notes and initials on the right side of the page.

Handwritten notes on the left side of the page.

999 1 cc 806P

54 JUN 30 1972

PX 157-1173  
CLC:lmb

STAN WILLIAMS, 16228 N. 28th Street, Phoenix, Arizona;  
RONALD LEE AUGUSTINOVICH, 1645 E. Thomas Road,  
Phoenix, Arizona;

## PROTECT INFORMANT

R. J. MATHEWS, 2401 W. Southern, Box 478, Tempe,  
Arizona;

DICK ORRMAN, P.O. Box 4142, Phoenix, Arizona;

TOM C. PAYNE, P.O. Box 828, Tucson, Arizona.

The Phoenix Office has opened recent files  
on only those above who are not known to the Phoenix  
Office.

## TO PROTECT FBI AND LOCAL AUTHORITIES INFORMANTS.

Efforts to identify  
the rest of the above list is currently being undertaken by  
the Phoenix Office.

PX T-1 in the enclosed LHM is

A report will be submitted on each accepted SAO  
member after initial background has been developed.

This LHM is being classified "Confidential" in  
order to protect the confidential informant who is of  
continuing value to the national defense of the U.S.



CONFIDENTIAL  
UNITED STATES DEPARTMENT OF JUSTICE

FEDERAL BUREAU OF INVESTIGATION

In Reply, Please Refer to  
File No.

Phoenix, Arizona  
May 31, 1972

SECRET ARMY ORGANIZATION

---

PX T-1 advised on May 26, 1972, that the captioned group has been endeavoring to take on an organizational structure since October, 1971. He states that, while the group is motivated by the same principles which brought the Minutemen into existence, the Secret Army Organization (SAO) is taking a more cautious approach than the Minutemen in its recruitment of membership, in order to avoid the assimilation of people of poor reputation.

In California, notably in San Diego, the SAO has recently had to sift the letters and applications being received there because of the obvious eccentric type person endeavoring to find acceptance in the group.

Concerning Arizona, source advised that the SAO has mailed a considerable amount of literature pertaining to the SAO to "conservative" thinking people, but has not at this time received response from the type of people they wish to affiliate. Consequently, no formal chapter or nucleus around which to organize has been formed in Arizona. However, a coordinator has been named and is operating. Source advised that not all former Minutemen will be accepted into the SAO.

Source advised that the SAO foresees a decentralized type of operation in each State, where in a revolutionary situation brought about by treasonous communist elements, the SAO could present a militant front immediately. Recent

CONFIDENTIAL

GROUP 1

Excluded from automatic  
downgrading and  
declassification

157-23577-26

CONFIDENTIAL

SECRET ARMY ORGANIZATION

---

bulletin material from SAO headquarters in San Diego has introduced the thought that "the basic battle facing our country today is the one between individualism and collectivism. In its political form it appears as personal freedom versus police-state regimentation.....In times of emergency, our members are not going to depend on General Headquarters for training material, bulletins and printed propaganda items. Local units and often the lone individual will have to improvise all these things. Communications to and from higher commands may be uncertain and the transmission of organization orders may be slow. We must have people who think for themselves. Equally important, we must have people who can see what needs to be done and get at it without being told."

The Minutemen is a paramilitant group organized in June, 1960, by Robert B. DePugh in Norborne, Missouri, as a resistance to the spread of communism in the United States by use of guerrilla tactics. DePugh is currently incarcerated in a Federal penitentiary for violation of the Federal Firearms Act.

The Patriotic Party has been the political arm of the Minutemen.

This document contains neither recommendations nor conclusions of the FBI. It is the property of the FBI and is loaned to your agency; it and its contents are not to be distributed outside your agency.

CONFIDENTIAL

2 \*

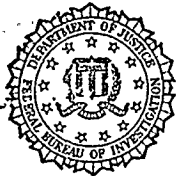

**CONFIDENTIAL**

**UNITED STATES DEPARTMENT OF JUSTICE  
FEDERAL BUREAU OF INVESTIGATION**

**Phoenix, Arizona  
May 31, 1972**

*In Reply, Please Refer to  
File No.*

**Title      SECRET ARMY ORGANIZATION**

**Character**

**Reference    Memorandum captioned and dated same  
                 as above at Phoenix, Arizona.**

All sources (except any listed below) whose identities are concealed in referenced communication have furnished reliable information in the past.

**CONFIDENTIAL**

This document contains neither recommendations nor conclusions of the FBI. It is the property of the FBI and is loaned to your agency; it and its contents are not to be distributed outside your agency.

UNITED STATES GOVERNMENT

# Memorandum

TO : BUREAU (157-23577)

DATE: 5/24/72

FROM : SAC, SAN DIEGO (157-2815)(P)

SUBJECT: SECRET ARMY ORGANIZATION (SAO)  
EXTREMIST MATTERS  
(OO: San Diego)

Enclosed for the Bureau's perusal are 2 copies of a San Diego area weekly newspaper, the Valley Grove News, dated May 3, 1972 and May 10, 1972, containing articles regarding the SAO.

*419 Sweetwater Road  
Spring Valley, Calif*

identified those present during the interview as follows:

- "Contact" - JERRY LYNN DAVIS
- "Spectacles" - HOWARD BARRY GODFREY
- "Walkie Talkie" - GEORGE MITCHELL HOOVER

Source pointed out that the article is written in a rather lurid style and added that much of the information in the article furnished by DAVIS is only propaganda designed to impress the reporter and the readers of the paper. He further noted that the second installment of the article appears to be incomplete as it is not continued on page three as indicated.

*A.J.*

The papers need not be returned to San Diego.

*A.J.*  
ENCLOSURE

- ② - Bureau (Enc. 2)(RM)
- 2 - San Diego

SLC:mlr  
(4)

ENCLOSURE ATTACHED  
REC 43

157-23577-25

JUN 2 1972

EX-109

EXT./INT. SEC.

UNITED STATES GOVERNMENT

# Memorandum

TO : ACTING DIRECTOR, FBI (157-23577)

DATE: 6/8/72

FROM : SAC, PHOENIX (157-1173) (P)

SUBJECT: SECRET ARMY ORGANIZATION (SAO)  
EXTREMIST MATTERS

ReBulet, 5/12/72.

Mrs. GUY ALDEN REEM, 4440 E. Arlington Road, Phoenix, Arizona, was interviewed at her home on 6/7/72, concerning the printed descriptive material which she received in the mail in April, 1972, from the Secret Army Organization (SAO). This printed material included a "Wanted for Treason" poster with President RICHARD NIXON as the subject.

Mrs. REEM advised that she does not know anything about the SAO and does not know who could have mailed the material to her. She noted that the material bore headquarters address in San Diego, California. She stated that in political circles she is known as a "conservative" and, consequently, she receives a lot of trash mail such as the printed material in question, which she mailed to Senator PAUL FANNIN of Arizona.

In the absence of pertinent information warranting an LHM, none will be submitted. The material in question was the subject matter of an LHM from the Phoenix Office on 12/21/71 and 3/8/72.

EX-115

REC-19

157-23577-24

- 2 - Bureau (RM)
- 1 - San Diego (Info) (RM)
- 1 - Phoenix

CLC:lmb  
(4)

JUN 12 1972



114  
60 JUN 21 1972

EXT. R-77 REC.

Buy U.S. Savings Bonds Regularly on the Payroll Savings Plan



UNITED STATES GOVERNMENT

# Memorandum

TO : ACTING DIRECTOR, FBI (157-23577)

DATE: 5/18/72

FROM : SAC, LOS ANGELES (157-7318) (P)

SUBJECT: SECRET ARMY ORGANIZATION (SAO)  
EXTREMIST MATTERS

Re San Diego airtel to Bureau, dated 4/11/72, and Bureau airtel to Las Vegas, Phoenix, San Diego, Seattle, and Los Angeles, dated 4/18/72.

Transmitted herewith to the Bureau are eight (8) copies of a letterhead memorandum (LHM) concerning captioned organization.

One (1) copy of this LHM is being disseminated to Secret Service, Los Angeles, in view of the plans of the organization to use disruptive tactics during the 1972 Republican Convention.

Sources utilized in the attached LHM are as follows:

- Source One
- Source Two
- Source Three
- Source Four

*y*

## LEADS

### LOS ANGELES

AT CARSON, CALIFORNIA: (1) Will contact local law agencies for any possible information on the Secret Army Organization.

(2) Will contact confidential sources in Los Angeles for any further information that may be available on the Secret Army Organization or possible activities of SAM NAPIER.

AT LOS ANGELES, CALIFORNIA: Will contact Mrs. BETTY MILLER, 4804 1/2 West 137th Street, Hawthorne, California, for possible information on NAPIER and the Secret Army Organization.

*5-21-72  
R/S  
wcl/jpo*

- ② - Bureau (Enc. 8) (RM)
- 3 - Los Angeles
- (1 - 157-656)

*ENCLOSURE*

REC-28

*157-23577-23*

2 1972  
HLG/clh

EX-109

MAY 22 1972

LA 157-7318

ADMINISTRATIVE

According to sources that have been contacted, there is no Secret Army Organization (SAO) in the Los Angeles area, and investigation thus far, has failed to disclose any associates or friends of SAM NAPIER that could be connected with NAPIER as a possible organizer of the SAO in the Los Angeles area. Several confidential sources are in a position to ascertain information about this organization should it become organized and active in Los Angeles. Contacts with these sources will be maintained for possible information on the SAO.

SAM NAPIER is currently undergoing investigation as to his possible connection with the Secret Army Organization (SAO) and possible affiliation with the National Socialist American Workers Party (NSAWP).

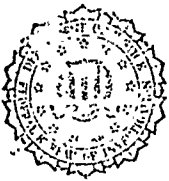

UNITED STATES DEPARTMENT OF JUSTICE

FEDERAL BUREAU OF INVESTIGATION

In Reply, Please Refer to  
File No.

Los Angeles, California  
May 18, 1972

SECRET ARMY ORGANIZATION  
EXTREMIST MATTERS

Source One, who has furnished reliable information in the past, advised on April 28, 1972, that there is no information available that such an organization as the Secret Army Organization exists in the Los Angeles area. Source added that there has been no past information of such a group.

On April 28, 1972, Source Two, who has furnished reliable information in the past, advised he could furnish no information on the Secret Army Organization or on an individual by the name of Sam Napier. Source advised the SAO is unknown to him.

On May 15, 1972, Source Three, who has furnished reliable information in the past, advised he had no information on the SAO or on Sam Napier, or on its possible organization in the Los Angeles area.

SUB-COMMITTEE ORGANIZATION

Source Four, who has furnished reliable information in the past, has previously advised that one Sam Napier has recently joined the SAO and is allegedly assisting JERRY LYNN DAVIS, Leader of the SAO in San Diego, California, in Davis' attempts to organize the SAO in Los Angeles. Source advised that Sam Napier had formerly been associated with the National Socialist American Workers Party (NSAWP), but he had left the group. Source said DAVIS claimed that NAPIER had recruited another SAO member, but could furnish no name. Further, Davis claimed there had been three additional members recruited in the SAO, one from Carson, California, but identities were not known.

The NSAWP, Post Office Box 11146, Santa Ana, California, was organized in the spring of 1971. According to the NSAWP, the white race and western civilization face the prospect of eventual destruction at the hands of the Jewish and Marxist "enemies". The organization intended to follow the "great example of ADOLF HITLER and so make it possible a new era of a truly advanced Aryan civilization." The NSAWP publishes a leaflet entitled "ATTACK!" and is headed by Commander EUGENE HAMILTON WINCHESTER, JR.

The following were checked in the Los Angeles area and all advised they could locate no record of the SAO or Sam Napier:

Credit Bureau,  
Voters Reg.  
Los Angeles PD

4/27/72  
5/1/72  
5/1/72

157-22577-23

ENCLOSURE

SECRET ARMY ORGANIZATION

On May 1, 1972, records of the Los Angeles County Sheriff's Office were checked by SC James G. Brown and they failed to show any information on the SAO but did reflect a record for Napier:

Name	Sam <sup>V</sup> Napier, Jr.
Date of Birth	August 18, 1918
Place of Birth	Beattyville, Kentucky
Sex	Male
Race	Caucasian
Height	5 feet 9 inches
Weight	200 pounds
Hair	Grey
Eyes	Brown
Social Security Account Number	<div style="border: 1px solid black; padding: 2px;">JFK Act 6 (3)</div>
Occupation	Trucker
Marital Status	Divorced
Drivers License Number	D0925598

Napier had been arrested on March 8, 1969, for drunk driving and his bail had been set at \$308.50.

The arrest record did not set forth any friends or associates of Napier's.

On February 25, 1972, Betty Miller, 4804 $\frac{1}{2}$  West 137th Street, Hawthorne, California, advised that Sam Napier lives at 4806 $\frac{1}{2}$  West 137th Street, Hawthorne, California. Mrs. Miller was interviewed previously in connection with another official Federal Bureau of Investigation (FBI) matter. She described Napier as a male, Caucasian, about sixty years of age, five feet ten inches tall, heavy build, and that he has no steady employment. Miller did not, at that time, furnish any known associates or friends of Napier's.

This document contains neither recommendations nor conclusions of the FBI. It is the property of the FBI and is loaned to your agency; it and its contents are not to be distributed outside your agency.

UNITED STATES GOVERNMENT

# Memorandum

TO : DIRECTOR, FBI (157-23577)

DATE: 5/17/72

FROM : SAC, SEATTLE (157-2815) (P)

*FIRAPPEL*

SUBJECT: SECRET ARMY ORGANIZATION (SAO)  
EXTREMIST MATTERS  
OO: SD

Re Bureau airtel to Las Vegas, 4/18/72.

Investigation at Seattle, Washington, has failed to reflect any information of an active SAO. Investigation has determined that CY ANDERSON has been actively involved as a gunsmith and a "gun nut" and is known to associate with a HUGH BAGLEY who is also considered a "gun nut" by the local office of AFD. Recent information has been obtained concerning the backgrounds of these individuals and due to the special assignments case agent is currently preparing an appropriate communication for dissemination which will be forthcoming in the very near future.

*WASH.*

*ow*

Whereas the Seattle Office has had numerous special assignments in the hijacking field as well as New Left matters, Buded of May 19, 1972, necessitates a reasonable extension of time to prepare this matter properly.

- 2 - Bureau (REG)
  - 2 - San Diego (157-2815) (REG)
  - 2 - Seattle
- SER:cmf  
(6)

*2-806900*

REC-33 / 157-23577-22

EX-112

6 MAY 22 1972

EXT. INT. SEC.



8199  
54 MAY 30 1972

FBI

Date: 4/27/72

Transmit the following in \_\_\_\_\_  
(Type in plaintext or code)

Via AIRTEL \_\_\_\_\_  
(Priority)

TO: DIRECTOR, FBI (157-23577) (100-451554)

FROM: SAC, PHOENIX (157-1173) (P)

JERRY LYNN DAVIS  
EXTREMIST MATTERS - SAO

SECRET ARMY ORGANIZATION (SAO)  
EXTREMIST MATTERS

OO: SAN DIEGO

ReButel, 4/25/72.

There are enclosed to the Bureau six (6) copies of a letterhead memorandum pertaining to captioned matter, under date of April 27, 1972.

Confidential informant PX T-1 in the LHM is

This LHM is being classified "Confidential" to protect the identity of this informant who is of continuing value to the internal security of the U. S.

The Phoenix Office will pursue the matter with informant to learn of any concrete plans of the SAO in connection with possible confrontations at the Republican National Convention in San Diego this year.

REC-28

157-23577-21

UNRECORDED COPY FILED IN 100-451554

- 2 - Bureau (RM) (Encl.-6)
  - 2 - San Diego (RM) (Encl.-2) (157-2815)
  - 1 - Las Vegas (RM) (Info) (Encl.-1)
  - 1 - Los Angeles (RM) (Info) (Encl.-1)
  - 1 - Seattle (RM) (Info) (Encl.-1)
  - 2 - Phoenix  
(1 - 170-37-a)
- ENCLOSURE  
EX-112  
2cc-150  
1cc-CRD, SS  
R/S  
5-8-72  
WCP/jgo

7 MAY 1 1972

EXT. INT. SEC.

CLC:lpb

54 MAY 23 1972

Sent \_\_\_\_\_ M Per \_\_\_\_\_

Special Agent in Charge



CONFIDENTIAL  
UNITED STATES DEPARTMENT OF JUSTICE

FEDERAL BUREAU OF INVESTIGATION

Phoenix, Arizona  
April 27, 1972

In Reply, Please Refer to  
File No.

SECRET ARMY ORGANIZATION

---

PX T-1 advised on April 26, 1972, that during his contact with members of the Secret Army Organization (SAO) in February, 1972, Sam Davis, also known as Jerry Davis, and one Cy Anderson, posed the question to an SAO group as to what measures could be taken by the SAO to counter disruptions by revolutionary groups at the Republican National Convention. This question was never discussed at great length, but in this connection, one member suggested that old junk-type cars be parked at strategic locations where, in the event of confrontation with dissident elements, the SAO members could have access to the necessary weapons hidden in the cars. Since the time of the above discussion, however, SAO leadership appears to have had second thoughts on the matter because the latter have been heard to say that they are going to stay out of San Diego entirely during the Republican National Convention in order to preclude any untoward incident that could be attributed to the presence of the SAO and redound to the discredit of the SAO.

Informant advised that he has not been present when sources of weapons may have been discussed by the SAO, but states that he is aware of the fact that leaders of the SAO have attended gun shows at every opportunity, notably at Yuma, Arizona, on October 15, 16, 1971, and again at Yuma on February 25, 26, 1972, and at Phoenix, Arizona, on March 25, 26, 1972.

Source advises that the Secret Army Organization is a new paramilitary group that has been formed in California to replace the Minutemen organization. It is composed of ex-Minutemen under the direction of Jerry Davis of the San Diego area.

CONFIDENTIAL  
GROUP 1

Excluded from automatic  
downgrading and  
declassification

157-23577-21  
ENCLOSURE

1  
XEROX

MAY 22 1972

CONFIDENTIAL

SECRET ARMY ORGANIZATION

---

The Minutemen is a paramilitant group organized in June, 1960, by Robert B. DePugh in Norborne, Missouri, as a resistance to the spread of communism in the United States by use of guerrilla tactics. DePugh is currently incarcerated in a Federal penitentiary for violation of the Federal Firearms Act.

This document contains neither recommendations nor conclusions of the FBI. It is the property of the FBI and is loaned to your agency; it and its contents are not to be distributed outside your agency.

CONFIDENTIAL

- 2\* -





CONFIDENTIAL  
UNITED STATES DEPARTMENT OF JUSTICE  
FEDERAL BUREAU OF INVESTIGATION

Phoenix, Arizona  
April 27, 1972

In Reply, Please Refer to  
File No.

Title            SECRET ARMY ORGANIZATION

Character

Reference       Memorandum dated and captioned as  
above at Phoenix, Arizona.

All sources (except any listed below) whose identities are concealed in referenced communication have furnished reliable information in the past.

This document contains neither recommendations nor conclusions of the FBI. It is the property of the FBI and is loaned to your agency; it and its contents are not to be distributed outside your agency.

NR 17 SD 0077

1144PM 4-23-72 NIPEL WAF

TO: DIRECTOR, FBI (136-451554) (157-23577)

FROM: SAC, SAN DIEGO (157-2315)

JERRY LYNN DAVIS, EXTREMIST MATTER - SECRET ARMY ORGANIZATION

SECRET ARMY ORGANIZATION

EXTREMIST MATTER

ATTENTION IS CALLED TO THE FACT THAT EXTREMIST  
 ACTIVITIES AND POSSESSION OF EXPLOSIVES BY JERRY LYNN DAVIS  
 WERE INVESTIGATED DURING THE SUMMER OF NINETEEN SEVENTYONE UNDER  
 THE CAPTION, "JERRY LYNN DAVIS, AKA SAM DAVIS; EUGENE BROWN;  
 BOMBING MATTER". IN THIS MATTER DAVIS AND EUGENE BROWN DISCUSSED  
 THE BOMBING OF OFFICES OF THE INTERNAL REVENUE SERVICE AND  
 THE ALCOHOL, TOBACCO AND FIREARMS DIVISION (ATFD) IN RETALIATION  
 FOR ARRESTS OF SOME INDIVIDUALS AT A GUN SHOW. CERTAIN EXPLOSIVES  
 IN THE POSSESSION OF DAVIS AT THAT TIME WERE OBTAINED BY A SOURCE  
 OF INFORMATION OF THE FEDERAL BUREAU OF INVESTIGATION (FBI) AT  
 SAN DIEGO, AND WERE SUBSEQUENTLY DISPOSED OF. DEVELOPMENTS IN  
 THIS MATTER WERE DISCUSSED IN DETAIL WITH THE UNITED STATES

END PAGE ONE

157-23577-

MAY 9 1972

NOT RECORDED  
168 MAY 11 1972

57 MAY 15 1972

*G. G. [unclear]*  
*ra*

*5- Patton*  
*[Signature]*

157-23577-11

ORIGINAL FILED IN

PAGE TWO

SD 157-2815

ATTORNEY'S OFFICE AT SAN DIEGO AND IT WAS DETERMINED THAT NO SUCCESSFUL PROSECUTION COULD BE BROUGHT AGAINST DAVIS AND BROWN BECAUSE OF INSUFFICIENT EVIDENCE.

ON APRIL TWENTY SIX, NINETEEN SEVENTY TWO, THIS SOURCE, WHO HAS PROVIDED RELIABLE INFORMATION ON NUMEROUS OCCASIONS IN THE PAST, ADVISED NO RECENT DEVELOPMENTS HAVE BEEN MADE IN PLANS BY DAVIS AND THE SECRET ARMY ORGANIZATION (SAO), A RIGHT WING, PARAMILITARY ORGANIZATION AT SAN DIEGO, FOR DISRUPTIONS DURING THE REPUBLICAN NATIONAL CONVENTION (RNC). THE SOURCE EXPLAINED THAT DUE TO THE TIME INTERVAL UNTIL THE ADVENT OF THE RNC, SUCH PLANS HAD ONLY REACHED A SPECULATION OR DISCUSSION STAGE. FURTHERMORE, ACTUAL PLANS AND ACTIVITIES BY THE SAO WOULD DEPEND GREATLY ON THE NATURE OF CONDITIONS EXISTING DURING THE RNC I.E., NUMBER OF NEW LEFT DEMONSTRATORS, RIOTS, POLICE RETALIATION, ETC.

THE SOURCE HAD PREVIOUSLY RECEIVED INFORMATION TO THE EFFECT THAT SEVERAL CANNONS OF A TYPE SIMILAR TO THOSE USED IN THE CIVIL WAR MIGHT BE AVAILABLE FOR USE BY DAVIS AND HIS

END PAGE TWO

PAGE THREE

SD 157-2815

ASSOCIATES. ON APRIL TWENTY SIX, NINETEEN SEVENTY TWO, THE SOURCE STATED THAT TWO OF THESE ARE MAINTAINED IN THE FRONT YARD OF THE GUNSMOKE RANCH, ONE FIVE ZERO NINE HARBISON CANYON ROAD IN SAN DIEGO COUNTY AREA. THIS RANCH IS OWNED BY ALDEN EDWARD WILLIS, NOT A MEMBER OF THE SAO, HOWEVER, HE IS POLITICALLY SYMPATHETIC WITH AND FRIENDLY WITH DAVIS. THE SOURCE IS NOT SURE HOW READILY AVAILABLE THESE WEAPONS MIGHT NOW BE TO THE SAO. A THIRD CANNON, PREVIOUSLY REFERRED TO AS BEING UNDER CONSTRUCTION, IS NOW COMPLETE AND IS LOCATED IN THE BACKYARD OF SAO MEMBER STANLEY DON MC DADE, THREE TWO TWO ZERO SWEETWATER ROAD, LEMON GROVE, CALIFORNIA.

THE SOURCE ADVISED HE WAS ONLY TOLD OF EXISTENCE OF THE FOURTH CANNON AND DOES NOT KNOW THE OWNER OR LOCATION. THE SOURCE SAID HE UNDERSTANDS THESE WEAPONS ARE LEGAL UNDER BOTH STATE AND FEDERAL LAW.

THE SOURCE STATED TO HIS KNOWLEDGE, DAVIS IS NOT PRESENTLY MANUFACTURING OR SELLING FIREARMS OR EXPLOSIVES IN VIOLATION OF FEDERAL OR CALIFORNIA LAW. THE SOURCE ADVISED THAT APPROXIMATELY SIX MONTHS AGO HE OBSERVED DAVIS IN POSSESSION OF A

END PAGE THREE

PAGE FOUR

SD 157-2815

FULLY AUTOMATIC AR EIGHTEEN RIFLE IN POINT TWO TWO THREE CALIBER WHICH WAS RECEIVED EARLIER THE SAME DAY BY DAVIS FROM ONE RICHARD MILLER, SEVEN ONE EIGHT SIX GLENROY, SAN DIEGO. MILLER'S SOURCE OF THE AR EIGHTEEN IS NOT KNOWN BUT RUMOR IS THAT HE HAS CONTACT WITH A STOCKHOLDER OF THE MANUFACTURER, ARMALITE COMPANY, AND HAS ALSO HAD AR ONE EIGHT ZERO RIFLES (LEGAL CIVILIAN VERSION OF AR EIGHTEEN) FOR SALE WHEN NO ONE ELSE COULD GET THEM.

DAVIS SHOWED THE SOURCE THAT SAFETY LEVER ON HIS AR EIGHTEEN HAD THE THIRD POSITION FOR FULLY AUTOMATIC FIRE. THE SOURCE COULD NOT OBTAIN THE SERIAL NUMBER.

ON OR ABOUT MARCH TWENTY, NINETEEN SEVENTY TWO, THE SOURCE OBSERVED DAVIS TAKE DELIVERY OF A FULLY AUTOMATIC M DASH TWO CARBINE IN POINT THIRTY CALIBER FROM CY ANDERSON, ONE ZERO FOUR ONE EIGHT NORTHEAST ONE SIX EIGHT PLACE, BOTHELL, WASHINGTON, WHO IS KNOWN TO SOURCE AS A TRAFFICKER IN FIREARMS AND OTHER ITEMS OF QUESTIONABLE LEGALITY. THE SOURCE OBSERVED THE FULLY AUTOMATIC FIRE CONTROL LEVER ON THE WEAPON BUT WAS

END PAGE FOUR

PAGE FIVE

NOT IN POSITION TO OBTAIN SERIAL NUMBER. THE SOURCE ADVISED HE IS SURE DAVIS STILL POSSESSES THE A R EIGHTEEN RIFLE BUT DAVIS CLAIMS THIS WEAPON IS NOW "STASHED" AND ITS LOCATION NOT KNOWN TO SOURCE. SOURCE SAID DAVIS MAINTAINS M DASH TWO CARBINE IN BEDROOM AT HIS RESIDENCE, TWO THREE NINE THREE WASHINGTON STREET, SPRING VALLEY, CALIFORNIA; HOWEVER, DAVIS ASSURED SOURCE THAT CERTAIN PARTS HAVE BEEN REMOVED FROM BOTH RIFLES SO AS TO CAUSE THEM TO FIRE SEMI-AUTOMATIC ONLY.

ON SEPTEMBER TWENTYEIGHT, INSTANT, DAVIS OBSERVED BY SOURCE IN POSSESSION OF ABOUT TWO BLOCKS OF C-FOUR PLACTIC EXPLOSIVES WEIGHING TWO AND ONE QUARTER POUNDS EACH, ABOUT FOUR POUNDS OF TNT IN ONE HALF AND ONE POUND BLOCKS, ABOUT TWO POUNDS OF HPD PRIMERS IN ONE THIRD POUNDS BLOCKS, SOURCE KNOWS OF NO LEGAL BASIS FOR POSSESSION OF ITEMS BY DAVIS. SOURCE ADVISED THESE ITEMS WERE LAST KNOWN BY HIM TO BE LOCATED AT RESIDENCE OF SAO MEMBER GEORGE MITCHELL HOOVER, EIGHT SEVEN TWO ONE MAGNOLIA, SANTEE, CALIFORNIA, AND WERE SEEN THERE BY SOURCE AS LATE AS APPROXIMATELY FIRST OF APRIL, SEVENTYTWO.

END PAGE P FIVE

PAGE SIX

SD

ON APRIL TWENTYSEVEN, LAST, SPECIAL AGENTS OF FBI AT SAN DIEGO, USING A SUITABLE PRETEXT, OBSERVED TWO CIVIL WAR STYLE CANNONS ON THE PREMISES OF THE GUNSMOKE RANCH. ONE CANNON, OBVIOUSLY HAND MADE OR HOME MADE, HAD A BARREL APPROXIMATELY TWO FEET IN LENGTH WITH ABOUT A TWO INCH BORE AND WAS MOUNTED ON A SMALL FOUR WHEEL CARRIAGE OF AN OLD NAVY STYLE. THE SECOND CANNON APPEARED TO BE AN ORIGINAL CIVIL WAR PIECE WITH ABOUT A THREE FOOT BARREL HAVING ABOUT A THREE INCH BORE.

A THIRD CANNON WAS OBSERVED BY SPECIAL AGENTS THE SAME DAY IN THE BACKYARD OF THE MC DADE RESIDENCE BY DRIVING UP A DRIVEWAY COMMONLY SHARED BY THREE HOUSES. THIS GUN HAD A BARREL OF APPROXIMATELY FOUR FEET WITH CLOSE TO A FOUR INCH BORE AND WAS MOUNTED ON A HOME MADE TWO WHEEL CARRIAGE.

ON APRIL TWENTYEIGHT, NINETEEN SEVENTYTWO, DONALD GROSSMEYER, SPECIAL INVESTIGATOR, ATFD, SAN DIEGO, ADVISED NEITHER HE NOR HIS OFFICE HAD ANY KNOWLEDGE REGARDING RICHARD MILLER OR HIS ACTIVITIES. GROSSMEYER STATED THAT THE THREE CANNONS ARE LEGAL UNDER FEDERAL

END PAGE SIX

PAGE SEVEN

LAW BUT THOUGHT THEY MIGHT POSSIBLY HAVE TO BE REGISTERED TO BE  
LEGAL UNDER CALIFORNIA LAW.

SOURCE HAS STATED ON SEVERAL OCCASIONS HE WILL NOT TESTIFY  
AGAINST DAVIS AND OTHER SAO MEMBERS AND ASSOCIATES FOR FEAR OF  
HIS LIFE.

ADMINISTRATIVE.

REBUTEL TO SD APRIL TWENTYFIVE, LAST.

SOURCE UTILIZED IS

AGENTS OBSERVING THE THREE CANNONS ON APRIL TWENTYSEVEN,  
LAST, WERE STEVEN L. CHRISTENSEN AND EARL M. PETERSON.

THE PRETEXT USED AT GUNSMOKE RANCH WAS INQUIRY AS TO  
LOCATION OF "DEER PARK LODGE."

SAN DIEGO WILL INITIATE INVESTIGATION REGARDING RICHARD  
MILLER AND WILL MAINTAIN CLOSE CONTACT WITH

WILL ALSO CONDUCT OTHER ADDITIONAL  
INVESTIGATION TO VERIFY POSSESSION OF ILLEGAL WEAPONS AND  
EXPLOSIVES BY DAVIS AND OTHER SAO MEMBERS.

LHM FOLLOWS.

END

DEB FBI WASH DC



SAC, Phoenix (157-1173)

5/12/72

Acting Director, FBI (157-23577)-20

1 - Mr. W. C. Patterson

REC-14

EX-100

SECRET ARMY ORGANIZATION (SAO)  
EXTREMIST MATTERS

Enclosed are a letter from James W. Ziglar, Special Assistant, Internal Security Division, dated 5/3/72, captioned "Correspondence from Senator Paul Fannin"; letter dated 5/3/72 from A. William Olson, Acting Assistant Attorney General to Senator Paul Fannin; letter from Senator Fannin, dated 4/12/72, to CONF. SOURCE and letter from CONF. SOURCE, dated 4/3/72, to Senator Fannin, which had as enclosures three items published by the SAO.

Review of Bureau files concerning  
CONF. SOURCE

Unless your files contain information which would preclude such action, contact CONF. SOURCE for any additional information she may have regarding the SAO. Furnish Bureau and San Diego results of interview. Pertinent information should be furnished in an LHM. MAILED 11

Enclosures (7) 05

WCP:aso (4) 05

NOTE:

Enclosures indicate CONF. SOURCE received the unsolicited material from the SAO and forwarded it to Senator Fannin, who in turn furnished it to the Department of Justice. The Department of Justice informed Senator Fannin this matter was being referred to the FBI for its consideration. The SAO is an ultraconservative, paramilitary organization clandestinely formed during the Fall of 1971 in Arizona. Its membership is small and much of the training material as well as the ideology follows that of the Minutemen. Several members of the SAO were formerly Minutemen.

- Tolson \_\_\_\_\_
- Felt \_\_\_\_\_
- Campbell \_\_\_\_\_
- Rosen \_\_\_\_\_
- Mohr \_\_\_\_\_
- Bishop \_\_\_\_\_
- Gillier, E.S. \_\_\_\_\_
- Allahan \_\_\_\_\_
- Spicer \_\_\_\_\_
- Rad \_\_\_\_\_
- DeLoach \_\_\_\_\_
- Mohr \_\_\_\_\_
- Land \_\_\_\_\_

MAY 11 1972  
FBI

0 MAY 17 1972  
MAIL ROOM  TELETYPE UNIT

UNITED STATES GOVERNMENT

# Memorandum

TO : Clyde A. Tolson  
Acting Director  
Federal Bureau of Investigation

FROM : James W. Ziglar *J.W.Z.*  
Special Assistant  
Internal Security Division

SUBJECT: Correspondence from Senator Paul Fannin

DATE: *May 3, 1972*

Mr. Tolson	_____
Mr. DeLoach	_____
Mr. Mohr	_____
Mr. Bishop	_____
Mr. Casper	_____
Mr. Callahan	_____
Mr. Conrad	_____
Mr. Felt	_____
Mr. Gale	_____
Mr. Rosen	_____
Mr. Sullivan	_____
Mr. Tavel	_____
Mr. Trotter	_____
Tele. Room	_____
Miss Holmes	_____
Miss Gandy	_____

The attached material from Senator Paul Fannin and his constituent, **CONF. SOURCE** concerning the "Secret Army Organization" is forwarded to you for your consideration. I am also attaching a copy of our reply to Senator Fannin.

*W.C.P.*  
*J.W.Z.*  
*J.W.Z.*

*W.C.P. aso*  
*5/12/72*

EX-100

REC-14 157-23577-20

18 MAY 12 1972

*J.W.Z.*  
ENCLOSURE  
ENCLOSURE ATTACHED

Department of Justice  
Washington, D.C. 20530

May 3, 1972

Honorable Paul Fannin  
United States Senate  
Washington, D. C. 20510

Dear Senator:

This is in response to your recent referral of a letter from **CONF. SOURCE** and your reply to that letter concerning an organization calling itself the "Secret Army Organization."

The "Secret Army Organization" is apparently a paramilitary group with headquarters in San Diego, California. The organization is currently mailing unsolicited material of the type which **CONF. SOURCE** received. While the nature of this group and the materials they are publishing are offensive to a vast majority of Americans, groups such as this are guaranteed the right to organize and publish their views under the First Amendment to the Constitution guaranteeing freedom of speech and of the press. However, I hope you will assure **CONF. SOURCE** that where evidence is developed which reflects a violation of Federal law, the Government will take the appropriate action.

We are referring the material which **CONF. SOURCE** sent to you to the Federal Bureau of Investigation for its consideration.

If we can be of any further assistance, please contact us. We are returning your enclosure herewith.

Sincerely,

A. WILLIAM OLSON  
Acting Assistant Attorney General

Enclosure

PAUL J. FANNIN  
ARIZONA

United States Senate

WASHINGTON, D.C. 20510

RECEIVED  
DEPARTMENT OF JUSTICE

APR 21 5 07 PM '72

SPECIAL LITIGATION  
SECTION  
INTERNAL SECURITY  
DIVISION

April 12, 1972

[Redacted]

CONF. SOURCE

[Redacted] CONF. SOURCE

Thank you for sending me on the material received by you from the Secret Army Organization. In my opinion this is the worst type of material that can be circulated. It accomplishes no good purpose, but is capable of doing terrible harm.

I am sending this material to the FBI with the request that the group be investigated for possible criminal prosecution.

Thank you for bringing this to my attention.

With kindest regards.

Sincerely,

Paul Fannin  
United States Senator

PF/mlb

bc: Department of Justice  
Congressional Liaison

VIRGINIA STEWART  
DEPT. OF JUSTICE

APR 13 1972

INTERNAL SECURITY

APR 20 1972

Correspondence Control Unit  
Internal Security Division

146-1-8030  
DEF.  
6 APR 14 1972  
R. S. M.  
DEPUTY ATTORNEY GENERAL  
INTERNAL SECURITY DIV.  
Civil Section

CONF. SOURCE

Apr. 3, 72

Dear Senator Famin -

This file was sent to me last week. In case you haven't seen it before, am sending it on to you. I hate to think they have my name on their list but I don't want to correspond with them at all. Do you know any thing about this group?

Sincerely,

CONF. SOURCE

# JOIN THE SECRET ARMY ORGANIZATION

*An organization of loyal Americans,  
dedicated to the preservation of both  
national and individual freedom.*

1. To prepare the means of personal defense and survival in case of enemy attack.
2. To resist and expose the spread of communist influence and propaganda within our own national boundaries.
3. To investigate by means of our own secret memberships the infiltration of communist sympathizers into American organizations of government, business, labor, religion and education.
4. To resist by any and all means the passage of laws which regulate the private ownership of firearms or which detract from the individual's ability to defend his own family and personal property.
5. To promote knowledge and skill in the use of arms by our own members and by the general public.
6. To form in advance of actual need a secret underground organization equipped to spy upon, harrass and destroy troops of any foreign power that might occupy United States territory.
7. To lend assistance and support wherever possible to other resistance organizations, domestic or foreign, opposing communist expansion or subversion.
8. To pursue these programs as private citizens motivated only by patriotism and to remain entirely free of government subsidies or control.

The Secret Army Organization is a national organization of patriotic Americans who are preparing themselves as a last line of defense against communism. To exemplify the necessity of such an organization, we quote the 1960 Annual Report of the Committee on Un-American Activities as follows:

"Events of the past year have provided convincing evidence that the American people cannot rely completely on this country's armed forces to protect themselves from communist domination and slavery. This is not because our military forces lack the power or the will to defend this country, but rather because the nature of the attacks being made on the United States by its major and only significant enemy are so designed as to render conventional military forces as ineffective as possible for defense purposes."

Starting from nothing 50 years ago, communism now rigidly controls one-third of the human race and has subverted to varying degrees the remaining two-thirds. In the past 20 years the communists have conquered 20 sovereign nations, one by armed conquest and 19 by internal subversion or negotiation.

There is not one of these countries in which the communists rule by the consent of the people. Everywhere they must perpetuate themselves by terror. They remain in power only through the use of the most brutal police state tactics.

The communists consider their party workers not simply as an accessory to armed conquest but as the actual spearhead of any invasion into new territory. From this point of view the United States was "invaded" by Soviet troops more than 30 years ago. It has been authoritatively estimated that the communists now have an army of 500,000 combatants already landed on American shores and already working by the most insidious means to destroy our American way of life.

The cold war is very real. It must be fought and won. The only alternative is to lose and to lose means that future Americans for generations to come must live in terror and in slavery. Appeasement is futile. We cannot bargain with moral barbarians who never have and never will know the meaning of honesty.

Communism must be defeated, not merely resisted. We must rid our country of traitors and fellow travelers. We must embark on a massive offensive turning every communist trick - from propaganda to infiltration - against our mortal enemy. This is the one and only way to win the struggle for survival.

Send 20¢ in coin or stamps for full information on the Secret Army Organization programs and membership application to: S. A. O., P. O. Box 5791, San Diego, California 92105.

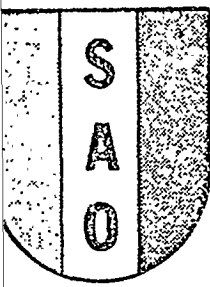

# SECRET ARMY ORGANIZATION

## GENERAL HEADQUARTERS

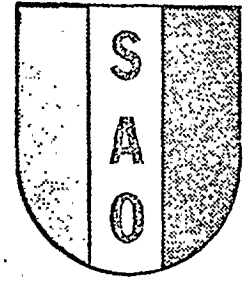

FROM: S. A. O. HEADQUARTERS

TO: FELLOW PATRIOTS

Greetings:

You may or may not have heard of the Secret Army Organization. In the past many patriotically oriented para-military groups have come and gone. Today the leadership of the S. A. O. is made up of those men who have weathered the storm of opposition and are more dedicated than ever to fighting the socialist parasites that are trying to enslave America.

If you care to join us we would welcome your application. However, we solicit your aid in any way that you can help. Your name has been coded so that you may contact us in a secure manner. Just use the coupon below or use the code number on it.

Sincerely yours,  
*Jordan Wells*  
Captain Jordan Wells  
S. A. O. Headquarters Staff

\*\*\*\*\*

Mail To: S. A. O.  
P. O. Box 5791  
San Diego, California 92105

050010

Code Number \_\_\_\_\_

- Please send membership information and application form.
- I wish to contribute \$\_\_\_\_\_ to help with the fight.
- I will help distribute literature, posters, leaflets, etc.
- I wish to be removed from your mailing list.



# WANTED

for TREASON



## NIXON

### DESCRIPTION

**FULL NAME:** Richard Milhous Nixon. **DATE OF BIRTH:** January 9, 1913 at Yorba Linda, California. **FORMER OCCUPATIONS:** Used car salesman, law clerk, second rate congressman, and mediocre Vice President. **PRESENT OCCUPATION:** Professional liar and double crosser (part time employment as United States President). **WEIGHT:** 170 pounds. **EYES:** brown. **HAIR:** black. **HEIGHT:** 5' 11". **RACE:** White. **NATIONALITY:** Claims American citizenship but actions prove this unlikely. **LAST KNOWN ADDRESS:** 1600 Pennsylvania Avenue, Washington, D. C. (Rumored to have a California hideout.)

### CRIMINAL RECORD

**RICHARD NIXON** (alias Cry-Baby Nixon, alias Tricky Dicky) is an expert in disguises and has successfully passed himself off as an anti-communist in the past. He may again try using this disguise if pressed for votes in 1972. Saying one thing, then doing the opposite is Nixon's MOA. While he campaigned in 1968 on a platform of curtailing socialism he has in fact done more to establish a socialistic dictatorship than either of the last two Democrat administrations. His economic policies have continued to enrich Big Industrialists while rising prices and higher taxes have all but reduced the average worker to a state of financial slavery. This criminal has even made vicious attacks on small children (forced busing to achieve "racial balance") and has caused the destruction of local school systems. **WARNING:** Nixon suffers from an **EMPEROR COMPLEX** and becomes extremely dangerous when criticized.

### CAUTION

Trickery and deceit are Nixon's trade-marks. At the present time Nixon and his chief henchman **HENRY (CZAR) KISSINGER** are engaged in forming an alliance with another gang of criminals, the Red Chinese. The **RED CHINA GANG** have slaughtered an estimated fifty million of their own people since coming to power. This Godless horde of barbarians killed thousands of Americans in the Korean War (shooting captured soldiers and starving and torturing prisoners of war). The **RED CHINA GANG** have been supplying the **NORTH VIETNAMESE BANDITS** with weapons and bullets to kill American soldiers in another no-win war in Vietnam. The very fact that Nixon is dealing with these **ARCH ENEMIES OF FREEDOM** is enough to convict him of treason. **DO NOT LET THIS CRIMINAL STEAL YOUR FREEDOM. DEMAND HIS ARREST BY PROPER AUTHORITIES AND HIS TRIAL FOR THE CRIME OF HIGH TREASON.**

4



Secret Army Organization

# Memorandum

Mr. Tolson	
Mr. Felt	
Mr. Campbell	
Mr. Rosen	
Mr. Mohr	
Mr. Bishop	
Mr. Miller, ES	
Mr. Callahan	
Mr. Casper	
Mr. Conrad	
Mr. DeLoach	
Mr. Cleveland	
Mr. Ponder	
Mr. Bates	
Mr. Wickert	
Mr. Walters	
Mr. Soyars	
Tele. Room	
Miss Holmes	
Miss Gandy	

TO : Director,  
Federal Bureau of Investigation

DATE: April 21, 1972

FROM: *ACM* Robert C. Mardian  
Assistant Attorney General  
Internal Security Division

SUBJECT: Jerry Lynn Davis  
Secret Army Organization

*Parkhill*

We note from your letterhead memorandum dated March 8, 1972 from Phoenix, Arizona, that Jerry Lynn Davis and other members of the Secret Army Organization met in Yuma, Arizona, and discussed preparations for the forthcoming Republican National Convention in San Diego, California. It is also noted from the report of SA Steven L. Christensen dated March 8, 1972 in San Diego, California, that Davis viewed the convention as "his big chance to do something that would be remembered;" and further that he had planned a sophisticated alibi to cover any bombings or other terrorist activities that he may engage in during the convention.

In this connection, it is requested that we be advised as expeditiously as possible of any further developments in Davis' plans for the convention including his acquisition of any weapons or explosives.

The report of SA Christensen also contains additional information from sources SD T-2 and SD T-3 pointing out that Davis said that he had ready access to illegal weapons and explosive materials. This report further advised that Davis had purchased \$500 worth of M-2 Carbine parts in May, 1971 for the purpose of making M-2 "enforcers," that Davis in September, 1971 had a cache of several hundred pounds of explosives including TNT, C-4, and rifle grenades and further that his group was in possession of three operational Civil War field artillery pieces with a fourth under construction.

*TEL BY SA 4/25/72  
W.P. 1050*

*EXP-1000  
100-451554-10*

*file cc-157-23577-Secret Army Organization  
5-wp*

*100-451554-Jerry Lynn Davis*

*157-23577-8*

APR 24 1972

NOT RECORDED  
191 MAY 11 1972

INT. SEC.

55 MAY 12 1972

It is requested that your sources be re-interviewed to determine if Davis is presently manufacturing, selling or in possession of any illegal weapons, explosives or explosive devices. It is further requested that any information you may acquire confirming such activities be furnished this office as expeditiously as possible.

With regard to the cannons noted above, it is requested that you determine their caliber and present location, including the weapon reportedly under construction in January, 1971.

CONFIDENTIAL

Acting Assistant Attorney General  
Internal Security Division

May 3, 1972

Acting Director, FBI

- 1 - Mr. A. W. Gray  
(Attention: Dally)
- 1 - Mr. T. J. Smith  
(Attention: Enright)
- 1 - Mr. R. P. Finzel
- 1 - Mr. W. C. Patterson

JERRY LYNN DAVIS  
EXTREMIST MATTERS -  
SECRET ARMY ORGANIZATION

SECRET ARMY ORGANIZATION  
EXTREMIST MATTERS

Reference is made to the letter of Robert C. Mardian, former Assistant Attorney General, Internal Security Division, dated April 21, 1972.

Confidential informants, who have previously furnished information regarding plans of Davis and members of the Secret Army Organization (SAO) to engage in disruptive activities at the forthcoming Republican National Convention in San Diego, were recontacted April 26, 1972, regarding latest developments in these plans. One informant indicated that SAO leaders appear to have had second thoughts regarding appearing at the Republican National Convention and that they have said they are going to stay out of San Diego during the Convention to preclude any incident that could be attributed to the presence of the SAO which would discredit the organization. Another informant reported there were no recent developments in the plans of Davis and the SAO and that due to the time interval until the Republican National Convention plans had only reached the speculation or discussion stage. This informant indicated actual plans and activities of the SAO would depend greatly on the nature of conditions existing during the Republican National Convention, such as the number of dissident demonstrators, riots, and police retaliation. 157-23577

ORIGINAL FILED IN 100-451554-8

The above letter mentions that the report of Special Agent Steven L. Christensen dated March 8, 1972, at San Diego, California, entitled "Jerry Lynn Davis, Extremist Matters" ~~is~~

NOT RECORDED  
MAY 10 1972

100-451554  
157-23577  
WCP:aso (9)

56 MAY 11 1972  
115

CONFIDENTIAL

Group 1

Excluded from automatic  
downgrading and  
declassification

SEE NOTE PAGE FOUR

DUPLICATE YELLOW

CONFIDENTIAL

Acting Assistant Attorney General  
Internal Security Division

Secret Army Organization," sets forth information from sources SD T-2 and SD T-3 regarding Davis' having access to illegal weapons and explosive materials. It was requested these sources be reinterviewed to determine if Davis is presently manufacturing, selling or in possession of any illegal weapons, explosives, or explosive devices. It was further requested that the caliber and present location of four Civil War artillery pieces, one which was under construction, be determined.

Our San Diego Office utilized SD T-2 and SD T-3 in the above report to further conceal the identity of one informant. This informant was recontacted on April 26, 1972, and stated Davis is not presently known to be manufacturing or selling firearms or explosives in violation of Federal or California laws. Informant claims approximately six months ago Davis was observed in possession of a fully automatic AR-18 rifle, .223 caliber, which was received that same day from Richard Miller, 7186 Glenroy, San Diego. Davis advised informant this weapon was altered to fire semi-automatic only. Its present location is not known.

On or about March 20, 1972, the informant observed Davis receive a fully automatic M-2 Carbine, .30 caliber, from Cy Anderson, 10418 Northeast 168th Place, Bothell, Washington. The source observed the fully automatic fire control lever on this weapon and claims Davis assured him this rifle was also altered to fire semi-automatic only. This carbine is maintained in Davis' bedroom at his residence, 2393 Washington Street, Spring Valley, California.

On September 28, 1971, the informant observed Davis in possession of two blocks of C-4 plastic explosive, weighing two and one-fourth pounds each; about four pounds of TNT in one-half and one-pound blocks; and about two pounds of HPD primers in one-third-pound blocks. Informant claims these items were last seen approximately April 1, 1972, at the residence of SAO member George Mitchell Hoover, 8721 Magnolia, Santee, California.

CONFIDENTIAL

CONFIDENTIAL

Acting Assistant Attorney General  
Internal Security Division

On April 26, 1972, the informant furnished the location of three Civil War type cannons and stated he had been told about the fourth one but did not know its location. On April 27, 1972, Special Agents of the FBI observed two Civil War style cannons on the premises of the Gunsmoke Ranch, 1509 Harbison Canyon Road, San Diego County, California. One cannon, obviously homemade, had a barrel approximately two feet in length, with about a two-inch bore, and was maintained on a small, old Navy style four-wheel carriage. The second cannon appeared to be an original Civil War cannon with about a three-foot barrel and having about a three-inch bore. This ranch is owned by Alden Edward Willis, who is not a member of the SAO but is politically sympathetic and friendly with Davis. A third cannon was observed by Special Agents in the back yard of SAO member Stanley Don McDade, 3220 Sweetwater Road, Lemon Grove, California. This cannon had a barrel approximately four feet in length with about a four-inch bore and was mounted on a homemade two-wheel carriage.

The informant stated he understands these cannons are legal under both state and Federal law.

On April 28, 1972, Donald Grossmeyer, Special Investigator, Alcohol, Tobacco and Firearms Division, Department of the Treasury, San Diego, California, advised his office had no knowledge regarding the previously mentioned Richard Miller. Mr. Grossmeyer stated that the above three cannons are legal under Federal law but thought they might possibly have to be registered to be legal under California law.

The informant, who has furnished information regarding weapons and explosives and activities of the SAO, has stated on several occasions he will not testify against Davis and other SAO members and associates for fear of his life.

- 3.-

CONFIDENTIAL

CONFIDENTIAL

Acting Assistant Attorney General  
Internal Security Division

Investigation is continuing to determine additional activities of Davis and the SAO. Corroborating information is being sought, particularly with regard to the aforementioned automatic rifles and explosives. The results of that investigation will be furnished you.

NOTE:

The SAO is an ultraconservative, paramilitary organization, that was clandestinely formed during the Fall of 1971 in Arizona. Membership has been small and much of the training as well as the ideology follows that of the Minutemen. Several involved in SAO were formerly Minutemen. Information was previously furnished the Department regarding disruptive activity planned at the forthcoming Republican National Convention in San Diego and also regarding past activities of SAO leader Jerry Lynn Davis' acquiring or possessing firearms and explosives. Above-mentioned letter requested most recent developments regarding SAO plans to disrupt Republican National Convention and information regarding Davis' acquisition of weapons and explosives.

Classified "Confidential" as information emanated from informants furnishing information on a continuing basis, unauthorized disclosure of which could be prejudicial to the defense interests of the Nation.

CONFIDENTIAL

Mr. Campbell	_____
Mr. Rosen	_____
Mr. Mohr	_____
Mr. Bishop	_____
Mr. Miller	_____
Mr. Callahan	_____
Mr. Casper	_____
Mr. Conrad	_____
Mr. DeLoach	_____
Mr. Glavin	_____
Mr. Harbo	_____
Mr. Hendon	_____
Mr. Jones	_____
Mr. Ladd	_____
Mr. Nichols	_____
Mr. Rosen	_____
Mr. Sullivan	_____
Mr. Tavel	_____
Mr. Trotter	_____
Tele. Room	_____
Miss Holmes	_____
Miss Gandy	_____

APR 27 1972  
TELETYPE

NR 05 PX CODE  
1125 AM URGENT 4-27-72 WJG  
TO DIRECTOR  
FROM PHOENIX (3P)

JERRY LYNN DAVIS, EXTREMIST MATTERS - SAO (BUFILE: ONE ZERO ZERO - FOUR FIVE ONE FIVE FIVE FOUR).

SECRET ARMY ORGANIZATION (SAO), EXTREMIST MATTERS (BUFILE: ONE FIVE SEVEN - TWO THREE FIVE SEVEN SEVEN).

PX T-ONE ADVISED ON APRIL TWENTYSIX SEVENTYTWO THAT DURING HIS CONTACT WITH MEMBERS OF THE SECRET ARMY ORGANIZATION (SAO) IN FEBRUARY, SEVENTYTWO, SAM DAVIS, ALSO KNOWN AS JERRY DAVIS, AND ONE CY ANDERSON, POSED THE QUESTION TO AN SAO GROUP AS TO WHAT MEASURES COULD BE TAKEN BY THE SAO TO COUNTER DISRUPTIONS BY REVOLUTIONARY GROUPS AT THE REPUBLICAN NATIONAL CONVENTION. THIS QUESTION WAS NEVER DISCUSSED AT GREAT LENGTH, BUT IN THIS CONNECTION ONE MEMBER SUGGESTED THAT OLD JUNK-TYPE CARS BE PARKED AT STRATEGIC LOCATIONS WHERE, IN THE EVENT OF CONFRONTATION WITH DISSIDENT ELEMENTS, THE SAO MEMBERS COULD HAVE ACCESS TO NECESSARY WEAPONS HIDDEN IN THE CARS. SINCE THE TIME OF THE

END PAGE ONE

~~32 MAY 9 1972~~

157-23577-

NOT RECORDED  
192 MAY 12 1972

57 MAY 15 1972

*Handwritten notes:*  
5-1-72  
5-1-72  
5-1-72  
ORIGINAL FILED IN  
100-451554-101



PAGE TWO

PX

ABOVE DISCUSSION, HOWEVER, SAO LEADERSHIP APPEARS TO HAVE HAD SECOND THOUGHTS ON THE MATTER BECAUSE THE LATTER HAVE BEEN HEARD TO SAY THAT THEY ARE GOING TO STAY OUT OF SAN DIEGO ENTIRELY DURING THE REPUBLICAN NATIONAL CONVENTION IN ORDER TO PRECLUDE ANY UNTOWARD INCIDENT THAT COULD BE ATTRIBUTED TO THE PRESENCE OF THE SAO AND REBOUND TO THE DISCREDIT OF THE SAO.

INFORMANT ADVISED THAT HE HAS NOT BEEN PRESENT WHEN SOURCES OF WEAPONS MAY HAVE BEEN DISCUSSED BY THE SAO, BUT STATES THAT HE IS AWARE OF THE FACT THAT LEADERS OF THE SAO HAVE ATTENDED GUN SHOWS AT EVERY OPPORTUNITY, NOTABLY AT YUMA, ARIZONA, ON OCTOBER FIFTEEN, SIXTEEN, SEVENTYONE, AND AGAIN AT YUMA ON FEBRUARY TWENTYFIVE, TWENTYSIX, SEVENTYTWO AND AT PHOENIX, ARIZONA ON MARCH TWENTYFIVE, TWENTYSIX, SEVENTYTWO.

END PAGE TWO



CODE

TELETYPE

URGENT

- 1 - Mr. A. Rosen
- 1 - Mr. E. S. Miller
- 1 - Mr. T. J. Smith
- 1 - Mr. G. C. Moore
- 1 - Mr. W. C. Patterson

4/25/72

TO SACS SAN DIEGO  
PHOENIX

FROM DIRECTOR FBI

JERRY LYNN DAVIS, EXTREMIST MATTERS - SAO (BUFILE: ONE ZERO ZERO DASH FOUR FIVE ONE FIVE FIVE FOUR).

SECRET ARMY ORGANIZATION (SAO), EXTREMIST MATTERS (BUFILE: ONE FIVE SEVEN DASH TWO THREE FIVE SEVEN SEVEN). BUDED: MAY ONE NEXT.

ASSISTANT ATTORNEY GENERAL (AAG) ROBERT C. MARDIAN, INTERNAL SECURITY DIVISION, DEPARTMENT OF JUSTICE, BY LETTER DATED APRIL TWENTY-ONE LAST REFERENCED PHOENIX LHM DATED MARCH EIGHT LAST CAPTIONED "SECRET ARMY ORGANIZATION" AND SAN DIEGO REPORT DATED MARCH EIGHT LAST CAPTIONED AS ABOVE WITH REGARD TO PREPARATIONS BEING MADE BY DAVIS AND OTHER SAO MEMBERS FOR FORTHCOMING REPUBLICAN NATIONAL CONVENTION IN SAN DIEGO.

AAG MARDIAN REQUESTED THAT SOURCES BE RECONTACTED AND HE BE ADVISED AS EXPEDITIOUSLY AS POSSIBLE FOR FURTHER DEVELOPMENTS IN

WCP:aso (8)

SEE NOTE PAGE THREE

157 - 23577 -

57 MAY 1 1972

NOT RECORDED  
89 APR 27 1972

ORIGINAL FILED IN 100-451554-7



TELETYPE TO SAN DIEGO AND PHOENIX  
RE: JERRY LYNN DAVIS  
100-451554  
SECRET ARMY ORGANIZATION (SAO)  
157-23577

PHOENIX AND SAN DIEGO SUTEL PERTINENT RESULTS IN FORM  
SUITABLE FOR DISSEMINATION NO LATER THAN MAY ONE NEXT.

NOTE:

See memorandum G. C. Moore to Mr. E. S. Miller,  
dated 4/25/72, captioned "Secret Army Organization, Extremist  
Matters," prepared by WCP:aso.

UNITED STATES GOVERNMENT

# Memorandum

TO Mr. E. S. Miller *EM*

FROM G. C. Moore *GCM*

SUBJECT SECRET ARMY ORGANIZATION  
EXTREMIST MATTERS

1 - Mr. A. Rosen  
1 - Mr. E. S. Miller  
DATE: 4/25/72

1 - Mr. T. J. Smith  
1 - Mr. G. C. Moore  
1 - Mr. W. C. Patterson

Tolson	_____
Felt	_____
Campbell	_____
Rosen	_____
Mohr	_____
Bishop	_____
Miller, E.S.	_____
Callahan	_____
Casper	_____
Conrad	_____
Dalbey	_____
Cleveland	_____
Ponder	_____
Bates	_____
Waikart	_____
Walters	_____
Soyars	_____
Tele. Room	_____
Holmes	_____
Gandy	_____

*p. J. Moore*

The purpose of this memorandum is to advise of receipt of letter from Robert C. Mardian, Assistant Attorney General (AAG), Internal Security Division, Department of Justice, 4/21/72, which requested any additional information regarding plans of the ultra-conservative, paramilitary Secret Army Organization (SAO) to disrupt the forthcoming Republican National Convention in San Diego and to obtain approval to send attached teletype directing recipients to submit requested information.

Jerry Lynn Davis was formerly active in the Minutemen in San Diego area and in the Fall of 1971 formed the SAO with headquarters in San Diego area. The SAO is composed currently of approximately 10 members in Phoenix and San Diego. Members of the group have a past history of stockpiling weapons and explosives and have discussed plans to disrupt the Republican National Convention. These plans basically consist of counterdemonstration to those by antiwar and revolutionary groups. Davis made mention of planning a sophisticated alibi to cover any bombing or terrorist act in which he may engage during the Convention.

San Diego informant has furnished extensive information received from Davis alleging possession or access to explosives and weapons including three cannons of Civil War vintage and one under construction. This information to date has not been corroborated. AAG Mardian has requested any additional data developed regarding plans to disrupt Republican National Convention and regarding illegal possession of weapons and explosives by Davis or members of SAO.

UNRECORDED COPY FILED IN 100-451554-439154-001

EX-114

REC-50

157-23577-19

157-23577  
Enclosure *Sent 4-25-72*  
1 - 100-451554 (Jerry Lynn Davis)

CONTINUED - OVER

7 MAY 9 1972

WCP:aso (7)

aso

51 MAY 11 1972

*5- [Signature]*

Memorandum to Mr. E. S. Miller  
Re: Secret Army Organization  
157-23577

In view of potential for violence of SAO and disruptive plans for Republican National Convention, investigations of this group and its members have been intensified and investigating offices instructed to be alert for violations of Federal antiriot statutes and Federal gun laws.

San Diego and Phoenix Divisions being instructed to recontact informants to obtain any additional data regarding plans of SAO members to disrupt Republican National Convention and information regarding whether Jerry Lynn Davis is presently manufacturing, selling or in possession of any illegal weapons, explosives or explosive devices. Results, along with any corroborating information developed, are to be furnished by 5/1/72.

ACTION:

That attached teletype to Phoenix and San Diego containing instructions in line with above be approved.

SENT 4-25-72  
7

wcp  
HEA

EM

DELETED

R

ds

just  
7

WGC

DJD  
JMK

F B I

Date: 4/11/72\*

Transmit the following in \_\_\_\_\_  
(Type in plaintext or code)

Via AIRTEL \_\_\_\_\_  
(Priority)

TO: DIRECTOR, FBI (157-23577)  
FROM: SAC, SAN DIEGO (157-2815)(P)

*CC 14  
HCP  
Pat [Signature]  
B*

*C* SECRET ARMY ORGANIZATION (SAO)  
EXTREMIST MATTERS

Re Bureau airtel to San Diego dated 3/30/72.

For the information of receiving offices, in referenced Bureau airtel, the Bureau instructed that, because of plans being made by the SAO involving the possibility of disruptions at the 1972 Republican National Convention to be held in San Diego, extremist informants and sources are to be targeted toward identifying all members and leaders of this group and to determine details of any plans for disruptive activities during the convention. Investigations of individuals members of the SAO are to be promptly handled and reported so that a determination can be made as to their potential for violence and whether they present a threat to the internal security of this country. Criminal violations, especially of the Federal Anti-Riot and Federal Firearms Statutes, are to be watched for.

The following is a list of known members of the SAO together with other supporting and background information as furnished by ~~\_\_\_\_\_~~ on 4/11/72:

San Diego, California Area

JERRY LYNN DAVIS  
2393 Washington  
Spring Valley, California  
SD 157-3001  
Status - Pending

*157-23577-18*  
*[Signature]*

APR 14 1972

- ② - Bureau
- 2 - Las Vegas (157-997)
- 2 - Los Angeles
- 2 - Phoenix (157-1173)
- 2 - Seattle
- 2 - San Diego

SLC:gdf (12)

Approved: \_\_\_\_\_ Sent \_\_\_\_\_ M Per \_\_\_\_\_

Special Agent in Charge

EXT. INT. SEC.



SD 157-2815

HOWARD BARRY GODFREY  
738 Graves  
El Cajon, California  
SD 100-14819  
Status - Closed

JAMES EVAN POTO  
3496 Olga Avenue  
San Diego, California  
SD 157-1816  
Status - Pending

FRANK YACOPEC  
722 Graves  
El Cajon, California  
SD 157-1820  
Status - Closed

ROBERT MAYER, JR.  
2204 Montclair  
San Diego, California  
SD 157-2931  
Status - Pending

PAUL RUPLINGER  
4567 Massachusetts  
San Diego, California  
SD 100-14301  
Status - Closed

CALVIN HENDELL FOX  
2426 Capitan Avenue  
San Diego, California  
SD 157-3170  
Status - Pending

GEORGE MITCHELL HOOVER  
Woodking Woodward,  
Lakeside, California  
SD 157-3017  
Status - Pending

SD 157-2815

Mrs. DONNA LEE HARTLEY  
615 North Melrose Drive  
Vista, California  
SD 157-3169  
Status - Pending

HOWARD FRANCIS CLARK  
1080 Sixth Avenue  
Ramona, California  
SD 157-2546  
Status - Pending

EDWARD ANDREWS  
Pacific Beach Area  
San Diego, California  
SD 157-2769  
Status - Pending

STANLEY DON MC DADE  
3220 Sweetwater Road  
Lemon Grove, California  
SD 157-2933  
Status - Pending

Where cases are shown to be closed, previous investigation of these individuals has reflected they do not meet the necessary criteria for inclusion on the ADEX.

Source advised that based on statements made by JERRY LYNN DAVIS, leader of the SAO at San Diego, he believes DAVIS may have several other individual members of the SAO in the San Diego area who are not known to source. Source explained that each person holding an official or leadership position in the SAO is encouraged to recruit members on his own who generally would not have become known to other people in the organization. In this regard he advised DAVIS recently claimed that a new SAO member was recruited through EDWARD ANDREWS.

SD 157-2815

This individual was described to source, and was a retired military man, who recently completed training in insurance investment and is to begin work soon with a large insurance company in the San Diego area.

Los Angeles, California, Area

Source advised that according to DAVIS, one SAM NAPIER has recently joined the SAO and is allegedly assisting DAVIS in his attempts to organize the SAO in the Los Angeles, California, area. Source said that according to DAVIS, NAPIER was formerly associated in the Los Angeles area with the National Socialist American Workers Party (NSAWP) under SCOTT WINCHESTER, but left that group. DAVIS claimed NAPIER has allegedly recruited another SAO member whose name is not known to the source. Furthermore, DAVIS claims to have three additional SAO members in the Los Angeles area, one who resides at Carson, California, and another who is supposed to move to the State of Oregon in the near future. The identities of these three individuals are not known to the source.

Seattle, Washington, Area

Source advised that according to DAVIS, CY ANDERSON and another individual named (FNU) BAGWELL are allegedly members of the SAO in that city. DAVIS claims ANDERSON has recruited additional members for the organization there.

Phoenix, Arizona, Area

Source advised that an individual named EVERETT MOORE at Phoenix, Arizona, is allegedly a member of the SAO. Source said DAVIS claims that the largest single group of SAO members is supposed to be located at Phoenix under the direction of MOORE. Source said DAVIS has indicated that SAO recruiting literature which is distributed in Arizona has its own separate Post Office Box number in the San Diego area, this number not being known to the source. Mail received at this post office box is picked up by DAVIS and sent, sealed to MOORE for his use.

SD 157-2815

In addition, DAVIS claims that the individual who was formerly leader of the Bishop Faction of the American Nazi Party at Phoenix, Arizona, and one of his associates, have joined the SAO and sent a full year's dues at one time. This first individual was also alleged to be State Director for the State of Arizona for SCOTT WINCHESTER's group, the NSAWP. According to DAVIS, these individuals left the NSAWP in order to join the SAO.

Las Vegas, Nevada, Area

Source advised he is not exactly sure what is happening with regard to the SAO at Las Vegas, and added DAVIS has indicated he thinks he will have to make another trip to Las Vegas in order to get things going well there for the SAO.

Source advised that the SAO appears to have been receiving a considerable quantity of mail from several places in the United States, but primarily from the Western states. He said most membership fees and dues have been sent by money order and that DAVIS has a business establishment located in El Cajon, California, which will allow him to cash these money orders signing any name to them he wishes.

Source said that as a rough estimate he would guess that approximately 40 membership applications have been received so far by the SAO. He said he felt the identities of many of these may never come to his attention.

LEADS

All receiving offices are requested to alert appropriate informants and sources of information to the SAO to identify actual and potential members of this organization. Thereafter, individuals identified should be promptly and thoroughly investigated to determine their potential for violence and disruptive activities during the Republican National Convention.

SD 157-2815

LEADS Cont'd

LOS ANGELES

Will identify SAM NAPIER and his associates to determine whether they may be involved in the SAO.

PHOENIX

Will determine the size of any SAO group being operated by EVERETT MOORE. Will also attempt to identify the former American Nazi Party leader and his associate who have allegedly joined the SAO.

SEATTLE

1. Will determine the nature and size of any group being operated by CY ANDERSON and determine the extent of its affiliation with the SAO.

2. Will attempt to identify (FNU) BAGWELL, apparently an associate of CY ANDERSON.

SAN DIEGO

1. Will follow and report activities of the SAO in the San Diego area.

2. Will attempt to identify additional members of the SAO, including the retired military man supposedly recruited by EDWARD ANDREWS.

airtel

4/18/72

To: SACs, Las Vegas (157-997)  
Los Angeles  
Phoenix (157-1173)  
San Diego (157-2815)  
Seattle

1 - Mr. G. C. Moore  
1 - Mr. D. A. Brumble  
1 - Mr. W. C. Patterson

From: Director, FBI (157-23577)

SECRET ARMY ORGANIZATION (SAO)

EXTREMIST MATTERS

BUDED: 5/19/72

9

*[Handwritten signature]*

ReSDairtel 4/11/72.

Referenced airtel sets forth data available to an informant of the San Diego Division pertaining to SAO efforts to organize chapters and recruit members in territories of the various field divisions. This group, which has several former members of the Minutemen and uses literature similar to that formerly used by the Minutemen, has indicated it plans to cause disruptive actions at the Republican National Convention in San Diego in August, 1972.

Recipient offices, except Las Vegas, are to initiate investigations of SAO to identify the leaders and members in the various chapters and to determine their activities and objectives. Active investigations of individual members are to be opened to develop background information and to determine the extent of their involvement with SAO. These investigations are to receive prompt investigative attention in view of the organization's apparent intent to cause disruptions at the Republican National Convention. Consideration should be given to an early interview after appropriate

*[Handwritten initials]*

MAILED 23  
APR 16 1972  
FBI

REC-3  
ST-112

157-23577-17  
19 APR 18 1972  
SEE NOTE PAGE TWO

WCP:aso (14)

- Tolson \_\_\_\_\_
- Felt \_\_\_\_\_
- Campbell \_\_\_\_\_
- Rosen \_\_\_\_\_
- Mohr \_\_\_\_\_
- Bishop \_\_\_\_\_
- Miller, E.S. \_\_\_\_\_
- Callahan \_\_\_\_\_
- Casper \_\_\_\_\_
- Conrad \_\_\_\_\_
- Dalbey \_\_\_\_\_
- Cleveland \_\_\_\_\_
- Ponder \_\_\_\_\_
- Bates \_\_\_\_\_
- Waikart \_\_\_\_\_
- Walters \_\_\_\_\_
- Soyars \_\_\_\_\_
- Tele. Room \_\_\_\_\_
- Holmes \_\_\_\_\_
- Gandy \_\_\_\_\_

*[Handwritten notes]*  
58 APR 17 1972  
ADM

*[Handwritten initials]*  
GCM  
page 2 of 2

*[Handwritten initials]*  
HEX

MAIL ROOM  TELETYPE UNIT

*[Handwritten initials]*  
WCP

Airtel to Las Vegas, et al.  
Re: Secret Army Organization (SAO)  
157-23577

authority is received to determine their informant potential and whether they present a threat of violence. Las Vegas should be alert for information regarding the formation of an SAO chapter within its territory, and upon receipt of such information, immediately advise the Bureau and initiate an investigation in line with the above instructions.

Phoenix, Los Angeles and Seattle are to submit results of investigations in form suitable for dissemination regarding SAO to reach Bureau no later than 5/19/72. In cover communications list names of members and whether investigation being conducted. Also include statement whether sufficient informant coverage of SAO is available, and if not, what corrective steps are being taken.

San Diego reopen investigations of those members named in referenced airtel which have been closed in order that their activities can be followed.

In view of the efforts to recruit new members, San Diego and recipient offices should take advantage of this opportunity to increase informant coverage so that a more complete analysis of this group can be made. San Diego, particularly, should expand its informant coverage so that all SAO members can be identified and advance plans for violence can be determined.

NOTE:

The SAO is an ultraconservative, paramilitary organization clandestinely formed during the Fall of 1971 in Arizona. The organization, which is headquartered in the San Diego territory, has confined its organizational efforts to the Rocky Mountain states. Estimated membership is approximately 40. Several former Minutemen are members and they use much of the same training material as the Minutemen. Immediate investigation is necessary to identify members and plans of this group as Jerry Lynn Davis, SAO leader and organizer, plans disruptive action at Republican National Convention.

airtel

3/30/72

To: SAC, San Diego (157-2815)

From: Director, FBI (157-23577)

- 1 - Mr. C. E. Enright
- 1 - Mr. R. J. Deily
- 1 - Mr. W. C. Patterson

SECRET ARMY ORGANIZATION (SAO)  
EXTREMIST MATTERS

Disruptive acts during the Republican National Convention in San Diego being planned by SAO leader Jerry Lynn Davis and discussion by SAO leaders in Yuma, Arizona, recently about preparations to control and counter dissident elements at the Convention should they "get out of hand" clearly indicate the necessity for intensifying the investigation of SAO and individual members. Extremist informants and sources are to be targeted toward identifying all members and leaders of this group as well as details of any disruptions planned during the Republican National Convention. Insure information regarding such disruptions are promptly submitted in accordance with Bureau instructions contained in Bureau airtel 11/2/71 entitled "Demonstrations During the Forthcoming Political Campaign."

San Diego as office of origin is to set out necessary leads to identify officers and members of SAO chapters determined forming in other field divisions. Investigations of individual members of SAO are to be promptly handled and reported so that a determination can be made as to whether they present a threat to the internal security and their potential for violence. Reportedly, most SAO members have firearms and some members in January, 1972, were attempting to obtain dynamite.

A<sup>2</sup> WCP:aso (6)  
ASO

SEE NOTE PAGE TWO

ST-114 REC-9 157-23577-16

MAILED 5  
MAR 30 1972  
FBI

10 MAR 30 1972

- Tolson \_\_\_\_\_
- Felt \_\_\_\_\_
- Campbell \_\_\_\_\_
- Rosen \_\_\_\_\_
- Mohr \_\_\_\_\_
- Bishop \_\_\_\_\_
- Miller, E.S. \_\_\_\_\_
- Callahan \_\_\_\_\_
- Casper \_\_\_\_\_
- Conrad \_\_\_\_\_
- Dalbey \_\_\_\_\_
- Cleveland \_\_\_\_\_
- Ponder \_\_\_\_\_
- Bates \_\_\_\_\_
- Waikart \_\_\_\_\_
- Walters \_\_\_\_\_
- Soyars \_\_\_\_\_
- Tele. Room \_\_\_\_\_
- Holmes \_\_\_\_\_
- Gandy \_\_\_\_\_

58 APR 5 - 1972

MAIL ROOM  TELETYPE UNIT

wcp



Airtel to San Diego  
Re: Secret Army Organization (SAO)  
157-23577

You should be alert during these investigations to possible violations of Federal antiriot statutes as well as Federal gun laws. Information being developed during the investigations concerning possible criminal violations may subsequently be utilized during prosecutive action as evidence and should be developed and preserved accordingly.

Submit by airtel names of all individuals identified as SAO members and current status of investigations.

NOTE:

The SAO, an ultraconservative, paramilitary organization, was clandestinely formed during the Fall of 1971 in Arizona. Membership has been small and they use much of the same training material as the Minutemen. Several involved in SAO were formerly Minutemen. In view of their plans for disruptive activity during the Republican National Convention, it is necessary to swiftly identify the leaders and members as well as details of the disruptive activities.

UNITED STATES GOVERNMENT

# Memorandum

TO : DIRECTOR, FBI (157-23577)

DATE: 3/8/72

FROM : SAC, PHOENIX (157-1173) (P)

*Albright*  
*[Handwritten signature]*

SUBJECT: SECRET ARMY ORGANIZATION  
EXTREMIST MATTERS  
OO: San Diego

*[Handwritten initials]*  
*[Handwritten scribble]*

There are enclosed to the Bureau six (6) copies of a letterhead memorandum (LHM) which is self-explanatory. Two copies of the LHM are being designated for San Diego, Sacramento, Kansas City; and one each for information for Las Vegas, Seattle, Detroit and Baltimore. One copy each of this LHM is being disseminated locally to U. S. Secret Service and the Alcohol, Tobacco and Firearms Division for information.

*[Handwritten signature]*

The LHM is classified CONFIDENTIAL in order to protect the confidential source who is of continuing value and whose exposure could be detrimental to the national defense.

The confidential source PX T-1 is ~~\_\_\_\_\_~~

LEADS:

5

*ATFD*  
*CRD, IUC*

THE SACRAMENTO DIVISION

AT SACRAMENTO, CALIFORNIA

Will search California license plates 99704-F and VES-494 through records of the California Motor Vehicle Division to establish the registered owners of these license plates.

THE PHOENIX DIVISION

AT PHOENIX, ARIZONA

Will maintain contact with ~~\_\_\_\_\_~~ for information concerning the activities of the SAO.

- 2 - Bureau (RM) (Enc. 6) ENCLOSURE
- 2 - San Diego (RM) (Enc. 2)
- 2 - Sacramento (RM) (Enc. 2)
- 1 - Las Vegas (RM) (Enc. 1) (Info)
- 1 - Seattle (RM) (Enc. 1) (Info)
- 2 - Kansas City (RM) (Enc. 2)
- 1 - Detroit (RM) (Enc. 1) (Info)
- 1 - Baltimore (RM) (Enc. 1) (Info)
- CLC:gjk
- 2 - Phoenix

REC 28

157-23577-15

MAR 16 1972

cc 8060

EXT. INT. SEC.  
*[Handwritten signature]*

(14)  
APR 17 1972

Buy U.S. Savings Bonds Regularly on the Payroll Savings Plan



UNITED STATES DEPARTMENT OF JUSTICE  
FEDERAL BUREAU OF INVESTIGATION

In Reply, Please Refer to  
File No.

Phoenix, Arizona  
March 8, 1972

CONFIDENTIAL

SECRET ARMY ORGANIZATION (SAO)

On March 7, 1972, Confidential Source PX T-1, who has furnished reliable information in the past, advised that five members of the Secret Army Organization (SAO) met a second time at the fairgrounds at Yuma, Arizona on February 25 and 26, 1972, incidental to the gun show which was in progress there, as sponsored by KIWANIS. Those who met together were Jerry Davis, also known as Sam Davis; Barry Godfrey, also known as Howard Godfrey; Stan McDade; Bill Guiette and one other unknown person. California vehicles bearing license plates 99704-F and VES-494 were noted as belonging to this group.

At the meeting, Davis discussed the Republican National Convention which will be held in San Diego this year and which could be beset with problems from dissident groups with intent to disrupt the convention. In this connection, Davis spoke in terms of having an SAO training session some time before the convention for the purpose of preparing to control and counter dissident elements in the event the latter should get out of hand.

Source advised that the SAO is confining its recruiting efforts to the Rocky Mountain States, but that the group has established contact with former Minutemen in Michigan and Maryland.

Source, who is familiar with the political philosophy of the Minutemen, advised that the training material being used by the SAO is Minutemen material with an SAO caption to it; that, however, the political philosophy of the SAO is somewhat nebulous and in the formative stage. Source explained that the SAO appears to be playing down the anti-communist fight

CONFIDENTIAL

Group 1

Excluded from automatic  
downgrading and declassification.

157-23517-15

ENCLOSURE

MEMBER OF SUBJECT ORGANIZATION

CONFIDENTIAL

RE: SECRET ARMY ORGANIZATION (SAO)

and to be injecting themselves into any political matter which they deem to be un-American or fraught with political intrigue. In this connection, the SAO has produced a Wanted Flyer captioned, "WANTED FOR TREASON-NIXON" wherein the SAO depicts President Nixon with photograph as a criminal for having gone to China to "form an alliance with another gang of criminals, the Red Chinese." A copy of this flyer is being made a part of this memorandum.

The Minutemen is a paramilitant group organized in June, 1960, by Robert B. DePugh in Norborne, Missouri, as a resistance to the spread of communism in the United States by use of guerrilla tactics. DePugh is currently incarcerated in a Federal penitentiary for violation of the Federal Firearms Act.

The Patriotic Party has been the political arm of the Minutemen.

Two printed items of SAO organizational material captioned, "Organizational Correspondence to Members" and "Security Classification Guidelines" were also furnished by source and are made a part of this memorandum.

This document contains neither recommendations nor conclusions of the FBI. It is the property of the FBI and is loaned to your agency; it and its contents are not to be distributed outside your agency.

- 2 -

CONFIDENTIAL

SUBJECT: Organizational Correspondence To Members (Outline)

1. Letter To Prospective Member  
History Of The Secret Army Organization  
To Prospective Members Of The Secret Army Organization  
Membership Application Form  
Join The Secret Army Organization Leaflet (one)
2. Identification Number & Mail Drop Letter  
Practical Security Measures  
The Combat Team
3. Training Program Letter  
Preliminary Training Lesson  
a. Join The Secret Army Organization Leaflets (5)
4. Intelligence Training Program  
a. Book "Guerrilla" By Charles W. Thayer
5. Security Training Program  
a. Practical Security Measures
6. Propaganda Training Program  
a. Join The Secret Army Organization Leaflet  
b. How To Organize An Underground Army Leaflet
7. Recruiting Training Program  
a. Prospect Data Forms (5)

Special Instructions:

The above order should be followed in sending out the listed materials. Extra material such as organizational bulletins on Weapons, Personal Equipment, and Booby Traps should be sent to the new members to fill in spaces between the regular correspondence. The member should also be sent each new monthly bulletin. Our main concern during the Correspondence Phase will be in keeping up the interest of the new member until we can contact them personally, or put them in contact with other members. The best way to do this is to keep them busy with printed material.

SECURITY CLASSIFICATION - DEFINITIONS - PERSONNEL STATUS RANKINGS

- NOVICE** - Classification for new members who have not proven themselves or completed any of the Basic Training Programs.
- TRAINEE** - Classification for those members who have completed at least one of the Basic Training Programs or performed some other routine operation.
- MEMBER (D)** - Classification for personnel who have been members for a period of at least six months but have not completed the Basic Training Programs or taken part in any but routine operations.
- MEMBER (C)** - Classification for members who have completed the Basic Training Programs, but have not taken part in "Special Operations".
- MEMBER (B)** - Classification for members who have not completed the Basic Training Programs, but have proven themselves by taking part in "Special Operations".
- MEMBER (A)** - Classification reserved for members who have completed their Basic Training Programs and taken part in "Special Operations". All members in this classification should automatically rate the rank of Sergeant.
- LEADER (D)** - Classification for Team Leaders who have not proven themselves or organized their units to the excepted level. Team Leaders in this classification should be assigned the rank of Second Lieutenant.
- LEADER (C)** - Classification for Group Leaders who have proven themselves and organized their units to the proper level. Team Leaders in this classification should be assigned the rank of First Lieutenant.
- LEADER (B)** - Classification for Group Leaders who have not proven themselves or organized their units to the proper level. Group Leaders in this classification should be assigned the rank of First Lieutenant.
- LEADER (A)** - Classification for Group Leaders who have proven themselves and organized their units to the excepted level. Group Leaders in this classification should be assigned the rank of Captain.
- DIRECTOR** - Classification for Network Leaders. All personnel assigned this classification must have proven themselves beyond any doubt. All Network Directors rate a rank of at least Captain.
- COORDINATOR** - Classification for Regional or State Leaders. All personnel in this classification must have proven themselves beyond question. Coordinators rate a rank of at least Captain.

4

Domestic Intelligence Division

INFORMATIVE NOTE

Date 2/16/72

Attached pertains to information furnished by an extremist informant to the effect that the Secret Army Organization (SAO), a recently formed ultraconservative, paramilitary organization in California, intends to distribute posters containing photograph of President Nixon with words "Wanted for Treason" in large letters.

According to source, these posters will be distributed in Arizona, California, Washington, Washington, D. C., and possibly Nevada.

Copy of attached being furnished Internal Security Division, Inter-Division Information Unit of the Department, and Secret Service.

HEH:aso

HEH

RSS

GEMTDR

ASO  
1





PAGE TWO

SD 157-2815

PRESUMABLY THE WHITE HOUSE. THE POSTER WOULD CONCLUDE WITH THE SUGGESTION THAT NIXON SHOULD BE IMPEACHED AND TRIED FOR TREASON BY THE PROPER AUTHORITIES.

SOURCE ADVISED THE POSTERS ARE TO BE PRINTED ON FEBRUARY SIXTEEN SEVENTY TWO AND SHOULD BE DISTRIBUTED IN TIME TO APPEAR ON THE STREETS ON MONDAY, FEBRUARY TWENTY ONE, SEVENTY TWO. SOURCE SAID DISTRIBUTION IS EXPECTED TO TAKE PLACE AT SEATTLE, WASHINGTON, LOS ANGELES AND SAN DIEGO, CALIFORNIA, PHOENIX, ARIZONA, AND WASHINGTON, D.C., AND POSSIBLY LAS VEGAS, NEVADA. A TOTAL OF FIVE THOUSAND COPIES WILL BE PRINTED. SOURCE SAID HE EXPECTS DISTRIBUTION OF THE POSTERS WILL BE MADE AT SEATTLE, WASHINGTON BY CY ANDERSON, FORMER MINUTEMAN (MM) MEMBER AND SAO CONTACT; AT WASHINGTON, D.C., BY JESSE CLAYBURN STEVENS, RIGHT WING LEADER AND SAO CONTACT AT SILVER SPRINGS, MARYLAND; AT PHOENIX, ARIZONA BY EVERETTE MOORE, FORMER MM LEADER AND SAO CONTACT; AND AT LOS ANGELES AND LAS VEGAS BY UNKNOWN INDIVIDUALS.

END PAGE TWO

PAGE THREE

SD 157-2815

POSTERS ARE TO BE PRINTED BY BETTIE HAUGHTON, WIFE OF  
A FORMER WEST COAST MM LEADER, AND SUPPORTER OF SAO ON  
A PRESS BELONGING TO HER. U.S.A.

THE SAO AND THE MM ARE ULTRA CONSERVATIVE PARA MILITARY  
ORGANIZATIONS IN THIS COUNTRY.

ADMINISTRATIVE:

SOURCE REFERRED TO ABOVE IS

|| AIRMAIL COPIES OF THIS COMMUNICATION BEING DISSEMINATED  
TO APPROPRIATE OFFICES.

FOREGOING INFORMATION FURNISHED TO SPECIAL AGENT  
JOHN KEEFE, SECRET SERVICE, SAN DIEGO, ON FEBRUARY SIXTEEN,  
INSTANT, BY SPECIAL AGENT STEVEN L. CHRISTENSEN.

<sup>memo</sup>  
NO LHM FOLLOWS, HOWEVER MATTER WILL BE CLOSELY FOLLOWED.

PENDING.

END

DWH FBI WASH DC

HOLD

cc  
MR. TRAINOR  
ROOM 7107 930

UNITED STATES GOVERNMENT

# Memorandum

TO : DIRECTOR, FBI (157-23577)

DATE: 2/25/72

FROM : SAC, PHOENIX (157-1173) (P)

SUBJECT: SECRET ARMY ORGANIZATION  
EXTREMIST MATTERS

Re Phoenix let to Director, 2/3/72.

There are enclosed to the Bureau six (6) copies of a letterhead memorandum (LHM) incorporating pertinent material from re Phoenix letter of 2/3/72. Two copies each of the LHM being designated for auxiliary offices.

The confidential informant mentioned in the LHM is *m3* The LHM is classified CONFIDENTIAL to protect the identity of the above source who is of continuing value and whose exposure could be detrimental to the national defense.

The Phoenix Office will maintain contact with above source for information which would identify personalities and activities in above organization.

*Boaffman*  
*D. J. [unclear]*

ENCLOSURE

- 2 - Bureau (RM) (Enc. 6)
- 2 - Kansas City (RM) (Enc. 2)
- 2 - Las Vegas (RM) (Enc. 2)
- 2 - San Diego (RM) (Enc. 2)
- 2 - Seattle (RM) (Enc. 2)
- 2 - Phoenix

CLC:gjk  
(12)

REC-30

0-7 to PK 3-2-71 action  
Re PK let + LHM 2-25-72

157-23577-13

FEB 28 1972

Dissem. LHM to  
SS + ATFD  
Locally (ATFD)

SI-100

AGENCY: ~~SECRETARY OF DEFENSE~~  
 DEPT: ~~DEFENSE~~  
 MAR 2 1972  
 JOT/WEB  
 MAR 13 1972

1-806-D

EXT. INT. SEC.



UNITED STATES DEPARTMENT OF JUSTICE

FEDERAL BUREAU OF INVESTIGATION

In Reply, Please Refer to  
File No.

Phoenix, Arizona  
February 25, 1972

CONFIDENTIAL

SECRET ARMY ORGANIZATION

On January 31, 1972, a confidential source who has furnished reliable information in the past, made "underground bulletin" material available concerning captioned organization. This material bears the date, "January 1972." The material has been photocopied and is made a part of this memorandum.

The source advises that the leader of the above organization is one Jerry Davis from San Diego, California, who attended a gun show at Yuma, Arizona on October 15 through October 17, 1971. Investigation at Yuma, Arizona develops that one Jerry Davis occupied Room #12 of the Thunderbird Motel in Yuma, Arizona, starting from October 15, 1971 to October 17, 1971. At that time, he recorded that he was driving a Ford vehicle bearing California license QNB-857 and that his residence was at 2393 Washington, Lemon Grove, California.

Source advises that the Secret Army Organization is a new paramilitary group that has been formed in California to replace the Minutemen organization. It is composed of ex-Minutemen under the direction of Jerry Davis of the San Diego area.

The Minutemen is a paramilitant group organized in June, 1960, by Robert B. DePugh in Norborne, Missouri, as a resistance to the spread of communism in the United States by use of guerrilla tactics. DePugh is currently incarcerated in a Federal penitentiary for violation of the Federal Firearms Act.

The Patriotic Party has been the political arm of the Minutemen.

CONFIDENTIAL

Group 1

Excluded from automatic  
downgrading and declassification.

This document contains neither recommendations nor conclusions of the FBI. It is the property of the FBI and is loaned to your agency; it and its contents are not to be distributed outside your agency.

ENCLOSURE 157-23177-13

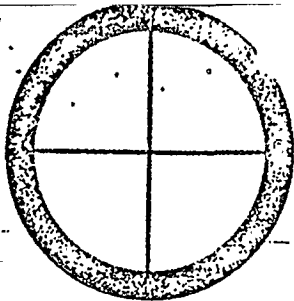

CONFIDENTIAL  
**SECRET ARMY ORGANIZATION**

**UNDERGROUND BULLETIN**

---

GENERAL HEADQUARTERS — JANUARY 1972

---

"God grants liberty only to those who love it and are always willing to guard and defend it". Daniel Webster

Fellow members,

This month's bulletin will deal mostly with "Booby Traps". Because of the length of this article we are only sending out the first half this month. The second half will be published in next month's bulletin. Future bulletins this coming year will contain material on psychological warfare, urban warfare tactics, communications, survival equipment, first aid, explosives, weapons, codes, and other related warfare subjects.

Those members who have not yet completed or started on the organization's basic training programs are hereby urged to do so. We cannot, in most cases, assign any member to an important underground project or to an organized team or group until they have completed this training program.

While headquarters cannot assign a member in the above classification to an established unit, any member can (and is encouraged to) recruit and form their own combat team (see December 1971 Bulletin). In many cases this may be the best policy in regards to personal security as the member would be working with the people he personally knows and trusts. If any member would like to form their own unit they should write to their assigned mail drop and the organization will send them further instructions along with a Team Recruiting Packet. The article on "The Dispersed Team" in this month's bulletin should help those members who wish to form their own Combat Team.

We are enclosing a small number of S. A. O. stickers with this month's bulletin. Please put them in your shirt pocket or billfold and as soon as possible stick them up in phone booths, at bus stops, or other public places that you visit. The stickers are already gummed and when wet will adhere firmly to glass, metal, or any other smooth surface. If our members would use these stickers along with the leaflets that are available, it would have a real psychological impact on the rest of the American people and give them evidence that there are still those among them who are willing to fight for the re-establishment of a Constitutional Republic. These first stickers are being sent to each member free, additional stickers and leaflets can be ordered on the monthly report form.

CONFIDENTIAL

When discussing a Secret Army Organization "Combat Team", we usually think of a small group of people who live very close to one another. Such an arrangement has certain advantages, such as ease of communication and travel for collective training and team operations, but there are also several disadvantages.

Among the disadvantages are these: Team members may be well acquainted with only a small geographical area. If forced to leave this area the team may be placed at a serious disadvantage. It is harder for a team of SAO members who live closely together to keep from attracting attention, thus unit security may be poor. If one member of the team is ever discovered and arrested by the enemy, chances are that all members of the team will be rounded up together.

These considerations have caused us to experiment with a new arrangement that we refer to as a "Dispersed Team". Such a team has the same number of members (usually six) as a regular Combat Team. Each team is split into two sections as is the old team. The members have the same type of individual specialties and duties.

The big difference lies in the fact that the team members may be located over a comparatively larger area - perhaps as much as 25 to 50 miles in diameter. In urban areas one team member may live in each of six different cities. Thus the team may range over a fairly large geographical area with at least one team member being familiar with the immediate territory through which they are traveling.

When active as part of an underground movement (as opposed to the classical forms of guerrilla warfare) the Dispersed Team has several other advantages. For example, if one member of the team gets too "hot" in his area, he automatically has five other hide-outs to which he can go for assistance or to which he can send his family for temporary safety. The Dispersed Team can conveniently cover a larger area in the fields of recruiting, psychological warfare, and propaganda. Operations of sabotage, surveillance and harassment of communist personnel, raids, and other combat type operations can be successfully conducted while moving a minimum of people over a minimum distance.

During the present period of deliberate delay the activities of the team will naturally be different from some future period in which all out warfare between our organization and our country's communist enemies develops.

If the team is to achieve its ultimate objectives the following activities must be provided for: (1) organization of and within the team, (2) communications between the team and higher command, (3) maintaining secrecy of team members, (4) maintaining a continuous and effective propaganda effort, (5) obtaining the necessary supplies and equipment for present and future needs, (6) training of the team in general, and of individual members in their own specialties.

When the required personnel are not available to form a full team, a three man section should be formed. When additional people are recruited the unit can then be expanded in an orderly fashion.

## BOOBY TRAPS

Broadly defined a booby trap can be any kind of apparatus in which a reaction unfavorable to the enemy is brought about when he unintentionally makes some act which triggers the reaction. The most common types of booby traps used in warfare involve an explosive charge which is set off by movement of a trip wire or the moving of some object which is connected to the trigger mechanism.

On occasion the explosive charge may be replaced by signal flares, gas, smoke or other chemical agents. The trigger mechanism may be either electric, mechanical, thermal or chemical.

**ELECTRICALLY OPERATED TRIGGERS.** Such trigger mechanisms are very easily arranged wherever a supply of electric blasting caps are available and also a suitable source of electricity. One of the most common electric type booby traps is to simply interrupt the electrical circuit in some building so that when the lights are turned on the explosive is detonated. This simple procedure applied to an automobile with a few sticks of dynamite has marked the end of more than one gangland hoodlum. To booby trap a car in this manner one side of the electric blasting cap can be attached to any metal part of the car while the other side is attached to a spark plug or the "cold side" of the ignition switch. In the first case the cap detonates the dynamite when the starter motor is turned over or if attached to the key switch detonating occurs when the ignition is turned on.

Any movable object can be booby trapped so that when it is moved some simple type electrical switch contact is closed to complete a circuit between a dry cell battery and the detonator. A very simple example would be to have one wire tacked along the edge of a door and the other wire tacked to the frame and extending out far enough that contact is made between the two when the door is opened. A slightly more refined trigger involves two small springs separated by some thin piece of insulation at one end as shown in Figure No. 1. When pressure is applied, the springs are held apart and when the pressure is released, the springs come together to make electrical contact. This may be placed in a door which is then closed to open the switch while the explosive is wired into the circuit. When the door is opened pressure is released and the charge explodes.

This simple trigger can be placed under the leg of a chair, a wooden box or any other movable object of sufficient weight. If the chair is moved or the box lifted the release of pressure will close the electrical circuit.

A person skilled in the placement of booby traps will not leave any part of the switch, wires or charge visible. Instead of

connecting the wires to the door itself he will take off the door frame, place the trigger mechanism at the edge of the door and then replace the frame so that the entire mechanism is hidden when the door is closed.

By taking off the frame of a window and drilling a hole out through the window casing the trigger mechanism can be placed so that the charge will be detonated by either raising or lowering a half open window.

A simple time delay mechanism can be arranged by placing one of these triggers under a glass jar filled with water. When enough of the water evaporates, the weight of the jar will no longer be sufficient to hold the contacts open.

Figure No. 2 shows another simple electrical trigger made from a spring clothes pin. The improvised contacts are held apart by a small wooden wedge in the jaws of the clothes pin. This wedge can be attached to a trip wire or other movable object. When it is withdrawn the clothes pin shuts and the electric circuit is completed.

A trigger of this type can be used to make a time delay mechanism in many different ways. The wedge may be connected by a loose cord to the end of a spring which is also attached to a tin can. Above this a second tin can full of sand or water is placed with a hole in the bottom so that the contents gradually fall through into the second can. When the weight of the lower can becomes enough to stretch the spring sufficiently the wedge will be pulled from the clothes pin. As an alternate method the spring may be already stretched out and held there by a second cord attached to some other solid object. The cord holding the spring could be placed through a candle so that it will be burned in two when the candle burned down a certain distance. An active imagination can devise countless ways for activating this type of trigger either by instant action or delayed action.

A clever derivative of this simple trigger is used in the "British book trap". In this case a book is hollowed out to contain a small battery and a quarter pound block of TNT which is detonated by an electrical blasting cap. The circuit passes through two contacts attached to opposite pages of the book but are held apart by some insulating material which is attached to the back of the bookcase. If the book is withdrawn from the case the contacts come together and the TNT is detonated.

A British ball bearing contact switch is shown in Figure No. 3. This type of contact is very useful in placing charges entirely within a movable object. For example, a suitcase could be laid on its side with the contact positioned inside in such a way that when the suitcase was picked up the ball bearing would roll forward and complete the contact. Similar electrically activated booby



traps could be placed in closed gasoline cans, canteens, ammunition boxes or dozens of other objects which an enemy would place right side up before opening. A plastic or glass test tube could be used instead of a metal case by sticking two wires through the cork in such a manner that the ball bearing would come in contact with both of them.

A surprisingly accurate timing device can be made with a tube of this type. Holding the tube with the open end up, first pour in a quantity of dried peas, then a measured amount of water, drop in the ball bearing (in this case a wad of tin foil could be used as well), finally put the cork in the top with the wire sticking down through. The water will cause the dried peas to swell which will push the ball bearing (or wad of tin foil) up until it makes contact with the two wires to complete the circuit. The time can be regulated from a few minutes to several hours depending on the length of the tube, the amount of water, and the quantity of peas used.

Far more sophisticated types of electrical triggers are manufactured some of which operate by photoelectric cell or even more difficult to recognize mechanisms. These may be used to safeguard record centers, important military or missile bases, etc. but are seldom encountered under battlefield conditions.

**MECHANICAL TRIGGERS.** These may be operated either by impact or by friction. The ordinary hand grenade employs an impact trigger. When the handle is released a spring operated lever snaps against a cap (similar to the priming cap in a shotgun shell) which in turn starts a short fuse to burn. This fuse leads to a blasting cap centered in an explosive charge.

The trigger mechanism of a "potato masher" hand grenade operates much like the firing pin of a bolt action rifle. In this case a spring activated plunger strikes a detonator. The plunger may be released by pulling out a pin as shown in Figure No. 4, by cutting a wire as shown in Figure No. 5 or by applying pressure to a slotted key as shown in Figure No. 6.

Explosion of the primer cap alone is not sufficient to detonate most military explosives. Generally a booster charge of a fairly sensitive explosive is detonated by the primer and this in turn detonates the main charge. In military use TNT is by far the most common explosive used in the main charge of booby traps. So called "plastic explosive" or "Composition C-3" contains 78 percent RDX and 22% plasticizer made up of mixture of dinitrotoluene, TNT, nitrocellulose and dimethylformamide. RDX is cyclotrimethylenetrinitramine which is manufactured by nitrating hexamethylenetetramine (which is obtained by the reaction of formaldehyde and ammonia).

Booster charges where necessary are usually tetryl or PETN. Common explosives used in primers are lead azide, lead styphnate

or the now largely discontinued mercury fulminate. Characteristics, uses and manufacture of explosives will be dealt with in another chapter.

A very simple device can be made from a screen door spring that will explode an ordinary rifle cartridge when activated by a trip wire. Although the "explosion" is almost harmless it can be very nerve racking to an approaching enemy.

A more deadly booby trap consists of a short piece of pipe which is driven into the ground. A plunger type trigger mechanism is dropped into the pipe and an ordinary rifle cartridge placed point up in the pipe so that perhaps one-half inch is exposed above the ground. The weight of a man stepping on the bullet releases the trigger and fires the cartridge which will penetrate well up into the leg or the body.

Some mechanical triggers are activated by friction just like striking a match on the rough material of the match cover. Figure No. 7 shows a cut-away drawing of the U.S. Army firing device, pull friction type M-2. The coated wire is covered with a gritty substance much like the strip on a book of matches. When this is pulled out through a container of flash compound (chemically similar to the match heads) the friction ignites the flash compound which may be used either to light a fuse or fire a blasting cap.

A crude but effective friction device can be prepared by sticking the end of a fuse in some small cylinder filled with match heads through which is placed a small strip of tin or heavy cardboard with a friction strip from match books glued to both sides.

In field use the friction type ignitor can be hidden in many ways connected with trip wires or attached to movable objects to set off either instant or delayed charges.

**THERMAL IGNITORS.** In some cases the ignitor, (fuse or primer) can be used as a trigger mechanism. For example in World War II the Germans were known to tear down fireplaces and cement them back together with hidden charges that would ignite when a fire was built. A simple hand grenade or mortar shell hidden in a hollow log by a burned out fire would, of course, explode if the log were used as fuel without being inspected.

A common trick is for a retreating army to leave behind coal oil lamps or lanterns filled with gasoline. An unthinking person who touches a match to such a lantern will nearly always be burned to death.

**CHEMICAL TRIGGERS.** These are more frequently used in the construction of time bombs than in booby traps. Figure No. 8

shows an Italian chemical delay igniter. The upper chamber contains acetone. When the piercing pin is pushed downward it penetrates the lead disc and allows the acetone to flow into the lower chamber. The acetone gradually dissolves the celluloid washer which holds back the striker. The time delay can be varied by placing different numbers of cellophane washers on the striker rod.

In several similar types of delayed mechanisms the striker is held back by a thin metal wire which is gradually dissolved when a solution of acid is allowed to surround it.

Other types of delay mechanisms may be constructed where a liquid is allowed to drop through a small hole into a lower container having a reactive substance attached part way up one wall. The liquid level in the chamber gradually raises until it comes in contact with the reactive substance which is the igniter. One suitable combination is sulfuric acid for the liquid and a mixture of potassium chlorate and sugar for the solid. Another suitable combination is plain water for the liquid and metallic sodium for the solid. There are many other combinations which a chemist might improvise from materials at hand.

There are some explosives so sensitive that they can be used as trigger mechanisms. Ammonium tri-iodide can be made from ordinary household ammonia and iodine crystals. If the iodine crystals are not available they can be obtained by evaporating sufficient volume of tincture of iodine in a flat glass dish.

Place two or three teaspoons of iodine crystals in a piece of kleenex and wet thoroughly with strong ammonia solution. A small amount of ammonia may be added from time to time making certain that it does not have the chance to dry out. After three or four tablespoons of ammonia solution have been absorbed and partly evaporated from the iodine it can be left to dry out. While wet ammonium tri-iodide is reasonably safe to handle. When dry, it is so sensitive that it detonates at the slightest touch. It may be exploded by a person walking on a wooden floor several feet away or a door being closed in the same building. The amount described above will produce a violent explosion and should be treated with extreme caution. Several similar compounds will be mentioned in the chapter on explosives.

One or two teaspoonsful of mercury fulminate of silver fulminate mixed (very gently) with ten percent coarse sand can be placed in a small packet of paper and attached to the upper side of an automobile tire with adhesive tape. When the tire rolls over it the fulminate will explode with sufficient power to destroy even a husky truck tire. These combinations also are very dangerous to handle.

## READY MADE BOOBY TRAPS

All national armies are supplied with a variety of manufactured trigger devices, charges, etc. to be used specifically as booby trap material. Most firing devices are threaded on one end with a standing size that allows them to be used either with prepared charges or with improvised charges made from mortar or artillery shells. Figure No. 9 shows a simple firing device attached to a hand grenade.

An antipersonnel mine of French manufacture is shown in Figure No. 10. The apparatus at the left side is a trigger mechanism that can be operated by a trip wire. When it is fired the flash passes through the "U" tube which propels a 60mm grenade into the air and at the same time ignites a 1/5 second delay pellet. The grenade explodes a few feet off the ground to shower metal fragments over a wide area. Total weight of mine is 5-1/2 pounds.

Guerrilla bands have sometimes used artillery shells or mortar shells in demolition work by placing them in a large pile of wood or other combustible material and building a bond fire around them until they exploded. For booby traps use, however, the projectile of an artillery shell is the only part of any value. Useful sizes include 75mm, 90mm, 105mm, and 155mm. In those artillery shells where the projectile is attached to the case, it is generally best to remove the projectile and discard the case. Artillery shell projectiles may be fused either in the nose or in the base. For most efficient use, the regular fuse must be unscrewed and a standard firing device (M10 Universal destructor) put in its place.

## IMPROVISED BOOBY TRAPS

Standard hand grenades can be used alone in booby traps in a number of methods. The simplest is to carefully remove the handle and wedge the grenade between two heavy objects strong enough to hold the spring in the cocked position.

Another trick is to cover a hand grenade with wet mud with just the safety pin ring sticking out. After the mud has hardened, it will hold the handle in place and the safety pin ring can be withdrawn. These harmless looking clumps of mud scattered along a dirt road will, of course, break open when hit by an automobile tire which will release the handle and fire the grenade. A similar trick is to place grenades in glass jars tight enough to hold the handle in place when the safety pins are withdrawn. At night these may be strung on a wire across a road and may not be seen by a car traveling at night with its lights off. When the bottles break the grenade handles are released and they soon explode.

It seems doubtful that man's ingenuity will ever be exhausted when it comes to improvising traps of various types. A rusty nail stuck to a board left where it will be stepped on by a running enemy may be just as deadly to that one individual as an atomic bomb. Open pits (sometimes with sharp stakes at the bottom) covered with flimsy camouflage is much older than the bow and arrow, but were still used by the Japanese in World War II.

"Dead falls" made from heavy tree limbs that fall when a victim releases them by tripping over a jungle vine can still be useful in guerrilla warfare.

Leaving behind poisoned food or bottled drinks is common. Alcoholic drinks are easily diluted with wood alcohol (temporary type antifreeze) equal to 1/4 their content of ethyl alcohol without detection. A total intake of 2 or 3 ounces will cause blindness or death in a few hours. Soft drinks can be easily poisoned with ethylene glycol (permanent type antifreeze) at the rate of 2 ounces per bottle. This dose is usually fatal and once symptoms develop there is no known antidote.

When five parts of potassium permanganate is mixed with one part of powdered sugar it forms a combination that will either explode (if confined) or burn with a flash if ignited in the open. A new idea might be to put three or four tablespoonsful of this material in an ash tray covered with a thin dust of cigarette ashes. The first person to put his cigarette out in that particular ash tray would be burned bad enough to be out of commission for quite some time. Black powder, if available, would actually explode if used in this way.

#### USE OF BOOBY TRAPS

It is obvious that the use of booby traps favors an army in retreat, and one of their greatest uses is to slow down pursuit. For most efficient use the laying of booby traps must be done in a planned and coordinated method. When time permits the entire area to be booby trapped should be reconnoitered and the placement of available material planned in such a way as to confuse the enemy, impede his progress and cause maximum number of casualties.

Generally speaking a large number of small booby traps are preferred to a few large ones. Two or more triggers may be attached to a single charge. Variety of types and settings is essential to effective use of booby traps in large numbers.

In the event that friendly troops or your own personnel may re-enter such an area later on, it is desirable that a written record and detailed maps be kept as to where booby traps are placed. When U.S. Army troops discover a place that is booby trapped they mark it with a sign which consists of a red triangle

pointed downward with a white circle in the middle and the word booby traps painted in white across the top.

When anti-vehicle mines are placed by regular army forces it is common practice to booby trap the mines so they will explode when being removed by personnel attempting to clear the area.

The use of booby traps is very adaptable to both guerrilla and counter-guerrilla activity. Guerrilla warfare involves two basic types of action: ambushes and raids. When the guerrillas ambush regular army forces, they are the ones that will make use of the booby traps. In raiding an enemy garrison or supply depot they must beware of booby traps that the regular forces have placed to protect their fixed positions.

The ambush may start when the leading vehicle of an enemy column strikes a mine or drives on to a bridge which is dynamited. Perhaps time delay booby traps activated by the first vehicle in the column may be used to destroy other vehicles several positions behind. Troops riding in a truck convoy may be expected to seek cover in ditches beside the road or other points of natural protection. If these ditches have been booby trapped beforehand, they will be killed in the very process of seeking shelter.

Before making any raid on a fixed enemy position, guerrilla forces should carefully consider the potential danger of booby traps. When regular army forces are being harassed by guerrillas they may be expected to leave supplies badly needed by the guerrillas in slightly protected warehouses as traps. These supplies may be heavily booby trapped and counter guerrilla forces may be waiting a short distance away to take pursuit. To guard against these things, the guerrilla should attempt to keep their target under surveillance for several hours or days before making the raid. They should observe the coming and going of enemy personnel. If the enemy is very careful to always come and go by the same route it may mean that other routes are booby trapped. If the supplies are not added to or taken from regularly, this may indicate that they are being used to bait a trap. By scouting the general area guerrilla forces should guard against surprise by other enemy forces waiting within danger distance.

After making either a raid or an ambush, guerrilla forces should place booby traps behind them to slow up pursuit. Real booby traps can be interspersed with imitation traps. To be safe the enemy will have to go around or de-activate the imitations and take just as much time doing so as if they were real. If the enemy becomes careless in handling your imitation traps, he will run the danger of getting killed by a live one. In planning the path of their retreat guerrilla forces should booby trap alternate routes which enemy forces might use to cut them off.

UNITED STATES GOVERNMENT

# Memorandum

TO : DIRECTOR, FBI (157-23577)

DATE: 2/3/72

FROM : SAC, PHOENIX (157-1173) (P)

SUBJECT: SECRET ARMY ORGANIZATION  
EXTREMIST MATTER

*13/1/72*  
*Shackman*

ReBulet 11/9/71; PXlet 12/22/71.

## CONF. SOURCE

..... furnished the registration cards for her motel for the month of October, 1971.

These records reflected that a JERRY DAVIS occupied Room 12 of this motel for two days starting at 10/15/71 and checked out the morning of 10/17/71.

JERRY DAVIS registered from an address of 2393 Washington, Lemon Grove, California, and gave a California license number of QNB-857, claiming to have been driving a Ford automobile.

A complete check of the records failed to locate anyone by the name of BARRY from San Diego; STAN from San Diego or a "SI" from Seattle, Washington; an EVERETT from Phoenix; a HOWARD CLARK from Ramona, California; a JOE BURTON from Las Vegas, Nevada; or a DOYLE from Las Vegas, Nevada.

..... advised however, that she noted on the registration cards that they had a California license vehicle, a Dodge with California license 286 AJO.

This party also came in on December 15, 1971, stayed two days, and left on the morning of 10/17/71.

- 2 - Bureau (Encl.-2) (Rm)
- 2 - San Diego (Encl.-2) (Rm)
- 2 - Seattle (Encl.-2) (Rm)
- 2 - Las Vegas (Encl.-2) (Rm)
- 2 - Phoenix (Encl.-2)

EX-112

REC-53

157-23577-12

22 FEB 8 1972

CLC:lmb  
(10)

*1 cc Encl retained Rm 806 JJI*

EXT. ENR. SEC.

*0-1 to PX 2/3/72  
Re furnished LHM setting out info via let 2/3/72  
JJI/gaw*



FEB 22 1972

Buy U.S. Savings Bonds Regularly on the Payroll Savings Plan

PX 157-1173  
CLC:lmb

*CONF. SOURCE* advised that the only other individual who stayed two days and came in on 10/15/71 was an R.N. JOHNSON, who had Room 22 and gave an address of 8582 Maple, Fontana, California. He gave a license number of 347 BUS California. There were two persons and one bed in this room. They checked in on December 15 and left the morning of 10/17/71.

It will be noted that the Kiwanis Gun Show in Yuma, Arizona, started on the evening of 10/15/71, and terminated shortly after noon on 10/17/71.

*CONF. SOURCE* advised on 1/31/72, that he received an "Underground Bulletin" from the Secret Army Organization by mail out of San Diego on 1/21/72. Two copies of this bulletin are being furnished as an enclosure to the Bureau and to each of the designated offices in this letter.

The Phoenix Office will maintain contact with *CONF. SOURCE* for information that would identify personalities and activity in this organization.



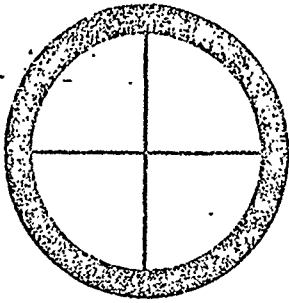

# SECRET ARMY ORGANIZATION

## UNDERGROUND BULLETIN

---

GENERAL HEADQUARTERS — JANUARY 1972

---

"God grants liberty only to those who love it and are always willing to guard and defend it". Daniel Webster

Fellow members,

This month's bulletin will deal mostly with "Booby Traps". Because of the length of this article we are only sending out the first half this month. The second half will be published in next month's bulletin. Future bulletins this coming year will contain material on psychological warfare, urban warfare tactics, communications, survival equipment, first aid, explosives, weapons, codes, and other related warfare subjects.

Those members who have not yet completed or started on the organization's basic training programs are hereby urged to do so. We cannot, in most cases, assign any member to an important underground project or to an organized team or group until they have completed this training program.

While headquarters cannot assign a member in the above classification to an established unit, any member can (and is encouraged to) recruit and form their own combat team (see December 1971 Bulletin). In many cases this may be the best policy in regards to personal security as the member would be working with the people he personally knows and trusts. If any member would like to form their own unit they should write to their assigned mail drop and the organization will send them further instructions along with a Team Recruiting Packet. The article on "The Dispersed Team" in this month's bulletin should help those members who wish to form their own Combat Team.

We are enclosing a small number of S. A. O. stickers with this month's bulletin. Please put them in your shirt pocket or billfold and as soon as possible stick them up in phone booths, at bus stops, or other public places that you visit. The stickers are already gummed and when wet will adhere firmly to glass, metal, or any other smooth surface. If our members would use these stickers along with the leaflets that are available, it would have a real psychological impact on the rest of the American people and give them evidence that there are still those among them who are willing to fight for the re-establishment of a Constitutional Republic. These first stickers are being sent to each member free, additional stickers and leaflets can be ordered on the monthly report form.

157-23544-12  
ENCLOSURE

## THE DISPERSED TEAM

When discussing a Secret Army Organization "Combat Team", we usually think of a small group of people who live very close to one another. Such an arrangement has certain advantages, such as ease of communication and travel for collective training and team operations, but there are also several disadvantages.

Among the disadvantages are these: Team members may be well acquainted with only a small geographical area. If forced to leave this area the team may be placed at a serious disadvantage. It is harder for a team of SAO members who live closely together to keep from attracting attention, thus unit security may be poor. If one member of the team is ever discovered and arrested by the enemy, chances are that all members of the team will be rounded up together.

These considerations have caused us to experiment with a new arrangement that we refer to as a "Dispersed Team". Such a team has the same number of members (usually six) as a regular Combat Team. Each team is split into two sections as is the old team. The members have the same type of individual specialties and duties.

The big difference lies in the fact that the team members may be located over a comparatively larger area - perhaps as much as 25 to 50 miles in diameter. In urban areas one team member may live in each of six different cities. Thus the team may range over a fairly large geographical area with at least one team member being familiar with the immediate territory through which they are traveling.

When active as part of an underground movement (as opposed to the classical forms of guerrilla warfare) the Dispersed Team has several other advantages. For example, if one member of the team gets too "hot" in his area, he automatically has five other hide-outs to which he can go for assistance or to which he can send his family for temporary safety. The Dispersed Team can conveniently cover a larger area in the fields of recruiting, psychological warfare, and propaganda. Operations of sabotage, surveillance and harassment of communist personnel, raids, and other combat type operations can be successfully conducted while moving a minimum of people over a minimum distance.

During the present period of deliberate delay the activities of the team will naturally be different from some future period in which all out warfare between our organization and our country's communist enemies develops.

If the team is to achieve its ultimate objectives the following activities must be provided for: (1) organization of and within the team, (2) communications between the team and higher command, (3) maintaining secrecy of team members, (4) maintaining a continuous and effective propaganda effort, (5) obtaining the necessary supplies and equipment for present and future needs, (6) training of the team in general, and of individual members in their own specialties.

When the required personnel are not available to form a full team, a three man section should be formed. When additional people are recruited the unit can then be expanded in an orderly fashion.

## BOOBY TRAPS

Broadly defined a booby trap can be any kind of apparatus in which a reaction unfavorable to the enemy is brought about when he unintentionally makes some act which triggers the reaction. The most common types of booby traps used in warfare involve an explosive charge which is set off by movement of a trip wire or the moving of some object which is connected to the trigger mechanism.

On occasion the explosive charge may be replaced by signal flares, gas, smoke or other chemical agents. The trigger mechanism may be either electric, mechanical, thermal or chemical.

**ELECTRICALLY OPERATED TRIGGERS.** Such trigger mechanisms are very easily arranged wherever a supply of electric blasting caps are available and also a suitable source of electricity. One of the most common electric type booby traps is to simply interrupt the electrical circuit in some building so that when the lights are turned on the explosive is detonated. This simple procedure applied to an automobile with a few sticks of dynamite has marked the end of more than one gangland hoodlum. To booby trap a car in this manner one side of the electric blasting cap can be attached to any metal part of the car while the other side is attached to a spark plug or the "cold side" of the ignition switch. In the first case the cap detonates the dynamite when the starter motor is turned over or if attached to the key switch detonating occurs when the ignition is turned on.

Any movable object can be booby trapped so that when it is moved some simple type electrical switch contact is closed to complete a circuit between a dry cell battery and the detonator. A very simple example would be to have one wire tacked along the edge of a door and the other wire tacked to the frame and extending out far enough that contact is made between the two when the door is opened. A slightly more refined trigger involves two small springs separated by some thin piece of insulation at one end as shown in Figure No. 1. When pressure is applied, the springs are held apart and when the pressure is released, the springs come together to make electrical contact. This may be placed in a door which is then closed to open the switch while the explosive is wired into the circuit. When the door is opened pressure is released and the charge explodes.

This simple trigger can be placed under the leg of a chair, a wooden box or any other movable object of sufficient weight. If the chair is moved or the box lifted the release of pressure will close the electrical circuit.

A person skilled in the placement of booby traps will not leave any part of the switch, wires or charge visible. Instead of

connecting the wires to the door itself he will take off the door frame, place the trigger mechanism at the edge of the door and then replace the frame so that the entire mechanism is hidden when the door is closed.

By taking off the frame of a window and drilling a hole out through the window casing the trigger mechanism can be placed so that the charge will be detonated by either raising or lowering a half open window.

A simple time delay mechanism can be arranged by placing one of these triggers under a glass jar filled with water. When enough of the water evaporates, the weight of the jar will no longer be sufficient to hold the contacts open.

Figure No. 2 shows another simple electrical trigger made from a spring clothes pin. The improvised contacts are held apart by a small wooden wedge in the jaws of the clothes pin. This wedge can be attached to a trip wire or other movable object. When it is withdrawn the clothes pin shuts and the electric circuit is completed.

A trigger of this type can be used to make a time delay mechanism in many different ways. The wedge may be connected by a loose cord to the end of a spring which is also attached to a tin can. Above this a second tin can full of sand or water is placed with a hole in the bottom so that the contents gradually fall through into the second can. When the weight of the lower can becomes enough to stretch the spring sufficiently the wedge will be pulled from the clothes pin. As an alternate method the spring may be already stretched out and held there by a second cord attached to some other solid object. The cord holding the spring could be placed through a candle so that it will be burned in two when the candle burned down a certain distance. An active imagination can devise countless ways for activating this type of trigger either by instant action or delayed action.

A clever derivative of this simple trigger is used in the "British book trap". In this case a book is hollowed out to contain a small battery and a quarter pound block of TNT which is detonated by an electrical blasting cap. The circuit passes through two contacts attached to opposite pages of the book but are held apart by some insulating material which is attached to the back of the bookcase. If the book is withdrawn from the case the contacts come together and the TNT is detonated.

A British ball bearing contact switch is shown in Figure No. 3. This type of contact is very useful in placing charges entirely within a movable object. For example, a suitcase could be laid on its side with the contact positioned inside in such a way that when the suitcase was picked up the ball bearing would roll forward and complete the contact. Similar electrically activated booby

traps could be placed in closed gasoline cans, canteens, ammunition boxes or dozens of other objects which an enemy would place right side up before opening. A plastic or glass test tube could be used instead of a metal case by sticking two wires through the cork in such a manner that the ball bearing would come in contact with both of them.

A surprisingly accurate timing device can be made with a tube of this type. Holding the tube with the open end up, first pour in a quantity of dried peas, then a measured amount of water, drop in the ball bearing (in this case a wad of tin foil could be used as well), finally put the cork in the top with the wire sticking down through. The water will cause the dried peas to swell which will push the ball bearing (or wad of tin foil) up until it makes contact with the two wires to complete the circuit. The time can be regulated from a few minutes to several hours depending on the length of the tube, the amount of water, and the quantity of peas used.

Far more sophisticated types of electrical triggers are manufactured some of which operate by photoelectric cell or even more difficult to recognize mechanisms. These may be used to safeguard record centers, important military or missile bases, etc. but are seldom encountered under battlefield conditions.

**MECHANICAL TRIGGERS.** These may be operated either by impact or by friction. The ordinary hand grenade employs an impact trigger. When the handle is released a spring operated lever snaps against a cap (similar to the priming cap in a shotgun shell) which in turn starts a short fuse to burn. This fuse leads to a blasting cap centered in an explosive charge.

The trigger mechanism of a "potato masher" hand grenade operates much like the firing pin of a bolt action rifle. In this case a spring activated plunger strikes a detonator. The plunger may be released by pulling out a pin as shown in Figure No. 4, by cutting a wire as shown in Figure No. 5 or by applying pressure to a slotted key as shown in Figure No. 6.

Explosion of the primer cap alone is not sufficient to detonate most military explosives. Generally a booster charge of a fairly sensitive explosive is detonated by the primer and this in turn detonates the main charge. In military use TNT is by far the most common explosive used in the main charge of booby traps. So called "plastic explosive" or "Composition C-3" contains 73 percent RDX and 22% plasticizer made up of mixture of dinitrotoluene, TNT, nitrocellulose and dimethylformamide. RDX is cyclotrimethylenetrinitramine which is manufactured by nitrating hexamethylene tetramine (which is obtained by the reaction of formaldehyde and ammonia).

Booster charges where necessary are usually tetryl or PETN. Common explosives used in primers are lead azide, lead styphnate

or the now largely discontinued mercury fulminate. Characteristics, uses and manufacture of explosives will be dealt with in another chapter.

A very simple device can be made from a screen door spring that will explode an ordinary rifle cartridge when activated by a trip wire. Although the "explosion" is almost harmless it can be very nerve racking to an approaching enemy.

A more deadly booby trap consists of a short piece of pipe which is driven into the ground. A plunger type trigger mechanism is dropped into the pipe and an ordinary rifle cartridge placed point up in the pipe so that perhaps one-half inch is exposed above the ground. The weight of a man stepping on the bullet releases the trigger and fires the cartridge which will penetrate well up into the leg or the body.

Some mechanical triggers are activated by friction just like striking a match on the rough material of the match cover. Figure No. 7 shows a cut-away drawing of the U.S. Army firing device, pull friction type M-2. The coated wire is covered with a gritty substance much like the strip on a book of matches. When this is pulled out through a container of flash compound (chemically similar to the match heads) the friction ignites the flash compound which may be used either to light a fuse or fire a blasting cap.

A crude but effective friction device can be prepared by sticking the end of a fuse in some small cylinder filled with match heads through which is placed a small strip of tin or heavy cardboard with a friction strip from match books glued to both sides.

In field use the friction type ignitor can be hidden in many ways connected with trip wires or attached to movable objects to set off either instant or delayed charges.

**THERMAL IGNITORS.** In some cases the ignitor, (fuse or primer) can be used as a trigger mechanism. For example in World War II the Germans were known to tear down fireplaces and cement them back together with hidden charges that would ignite when a fire was built. A simple hand grenade or mortar shell hidden in a hollow log by a burned out fire would, of course, explode if the log were used as fuel without being inspected.

A common trick is for a retreating army to leave behind coal oil lamps or lanterns filled with gasoline. An unthinking person who touches a match to such a lantern will nearly always be burned to death.

**CHEMICAL TRIGGERS.** These are more frequently used in the construction of time bombs than in booby traps. Figure No. 8

shows an Italian chemical delay igniter. The upper chamber contains acetone. When the piercing pin is pushed downward it penetrates the lead disc and allows the acetone to flow into the lower chamber. The acetone gradually dissolves the celluloid washer which holds back the striker. The time delay can be varied by placing different numbers of cellophane washers on the striker rod.

In several similar types of delayed mechanisms the striker is held back by a thin metal wire which is gradually dissolved when a solution of acid is allowed to surround it.

Other types of delay mechanisms may be constructed where a liquid is allowed to drop through a small hole into a lower container having a reactive substance attached part way up one wall. The liquid level in the chamber gradually raises until it comes in contact with the reactive substance which is the igniter. One suitable combination is sulfuric acid for the liquid and a mixture of potassium chlorate and sugar for the solid. Another suitable combination is plain water for the liquid and metallic sodium for the solid. There are many other combinations which a chemist might improvise from materials at hand.

There are some explosives so sensitive that they can be used as trigger mechanisms. Ammonium tri-iodide can be made from ordinary household ammonia and iodine crystals. If the iodine crystals are not available they can be obtained by evaporating sufficient volume of tincture of iodine in a flat glass dish.

Place two or three teaspoons of iodine crystals in a piece of kleenex and wet thoroughly with strong ammonia solution. A small amount of ammonia may be added from time to time making certain that it does not have the chance to dry out. After three or four tablespoons of ammonia solution have been absorbed and partly evaporated from the iodine it can be left to dry out. While wet ammonium tri-iodide is reasonably safe to handle. When dry, it is so sensitive that it detonates at the slightest touch. It may be exploded by a person walking on a wooden floor several feet away or a door being closed in the same building. The amount described above will produce a violent explosion and should be treated with extreme caution. Several similar compounds will be mentioned in the chapter on explosives.

One or two teaspoonsful of mercury fulminate of silver fulminate mixed (very gently) with ten percent coarse sand can be placed in a small packet of paper and attached to the upper side of an automobile tire with adhesive tape. When the tire rolls over it the fulminate will explode with sufficient power to destroy even a husky truck tire. These combinations also are very dangerous to handle.

## READY MADE BOOBY TRAPS

All national armies are supplied with a variety of manufactured trigger devices, charges, etc. to be used specifically as booby trap material. Most firing devices are threaded on one end with a standing size that allows them to be used either with prepared charges or with improvised charges made from mortar or artillery shells. Figure No. 9 shows a simple firing device attached to a hand grenade.

An antipersonnel mine of French manufacture is shown in Figure No. 10. The apparatus at the left side is a trigger mechanism that can be operated by a trip wire. When it is fired the flash passes through the "U" tube which propels a 60mm grenade into the air and at the same time ignites a 1/5 second delay pellet. The grenade explodes a few feet off the ground to shower metal fragments over a wide area. Total weight of mine is 5-1/2 pounds.

Guerrilla bands have sometimes used artillery shells or mortar shells in demolition work by placing them in a large pile of wood or other combustible material and building a bond fire around them until they exploded. For booby traps use, however, the projectile of an artillery shell is the only part of any value. Useful sizes include 75mm, 90mm, 105mm, and 155mm. In those artillery shells where the projectile is attached to the case, it is generally best to remove the projectile and discard the case. Artillery shell projectiles may be fused either in the nose or in the base. For most efficient use, the regular fuse must be unscrewed and a standard firing device (M10 Universal destructor) put in its place.

## IMPROVISED BOOBY TRAPS

Standard hand grenades can be used alone in booby traps in a number of methods. The simplest is to carefully remove the handle and wedge the grenade between two heavy objects strong enough to hold the spring in the cocked position.

Another trick is to cover a hand grenade with wet mud with just the safety pin ring sticking out. After the mud has hardened, it will hold the handle in place and the safety pin ring can be withdrawn. These harmless looking clumps of mud scattered along a dirt road will, of course, break open when hit by an automobile tire which will release the handle and fire the grenade. A similar trick is to place grenades in glass jars tight enough to hold the handle in place when the safety pins are withdrawn. At night these may be strung on a wire across a road and may not be seen by a car traveling at night with its lights off. When the bottles break the grenade handles are released and they soon explode.



It seems doubtful that man's ingenuity will ever be exhausted when it comes to improvising traps of various types. A rusty nail stuck to a board left where it will be stepped on by a running enemy may be just as deadly to that one individual as an atomic bomb. Open pits (sometimes with sharp stakes at the bottom) covered with flimsy camouflage is much older than the bow and arrow, but were still used by the Japanese in World War II.

"Dead falls" made from heavy tree limbs that fall when a victim releases them by tripping over a jungle vine can still be useful in guerrilla warfare.

Leaving behind poisoned food or bottled drinks is common. Alcoholic drinks are easily diluted with wood alcohol (temporary type antifreeze) equal to 1/4 their content of ethyl alcohol without detection. A total intake of 2 or 3 ounces will cause blindness or death in a few hours. Soft drinks can be easily poisoned with ethylene glycol (permanent type antifreeze) at the rate of 2 ounces per bottle. This dose is usually fatal and once symptoms develop there is no known antidote.

When five parts of potassium permanganate is mixed with one part of powdered sugar it forms a combination that will either explode (if confined) or burn with a flash if ignited in the open. A new idea might be to put three or four tablespoonsful of this material in an ash tray covered with a thin dust of cigarette ashes. The first person to put his cigarette out in that particular ash tray would be burned bad enough to be out of commission for quite some time. Black powder, if available, would actually explode if used in this way.

#### USE OF BOOBY TRAPS

It is obvious that the use of booby traps favors an army in retreat, and one of their greatest uses is to slow down pursuit. For most efficient use the laying of booby traps must be done in a planned and coordinated method. When time permits the entire area to be booby trapped should be reconnoitered and the placement of available material planned in such a way as to confuse the enemy, impede his progress and cause maximum number of casualties.

Generally speaking a large number of small booby traps are preferred to a few large ones. Two or more triggers may be attached to a single charge. Variety of types and settings is essential to effective use of booby traps in large numbers.

In the event that friendly troops or your own personnel may re-enter such an area later on, it is desirable that a written record and detailed maps be kept as to where booby traps are placed. When U.S. Army troops discover a place that is booby trapped they mark it with a sign which consists of a red triangle

pointed downward with a white circle in the middle and the word booby traps painted in white across the top.

When anti-vehicle mines are placed by regular army forces it is common practice to booby trap the mines so they will explode when being removed by personnel attempting to clear the area.

The use of booby traps is very adaptable to both guerrilla and counter-guerrilla activity. Guerrilla warfare involves two basic types of action: ambushes and raids. When the guerrillas ambush regular army forces, they are the ones that will make use of the booby traps. In raiding an enemy garrison or supply depot they must beware of booby traps that the regular forces have placed to protect their fixed positions.

The ambush may start when the leading vehicle of an enemy column strikes a mine or drives on to a bridge which is dynamited. Perhaps time delay booby traps activated by the first vehicle in the column may be used to destroy other vehicles several positions behind. Troops riding in a truck convoy may be expected to seek cover in ditches beside the road or other points of natural protection. If these ditches have been booby trapped beforehand, they will be killed in the very process of seeking shelter.

Before making any raid on a fixed enemy position, guerrilla forces should carefully consider the potential danger of booby traps. When regular army forces are being harrassed by guerrillas they may be expected to leave supplies badly needed by the guerrillas in slightly protected warehouses as traps. These supplies may be heavily booby trapped and counter guerrilla forces may be waiting a short distance away to take pursuit. To guard against these things, the guerrilla should attempt to keep their target under surveillance for several hours or days before making the raid. They should observe the coming and going of enemy personnel. If the enemy is very careful to always come and go by the same route it may mean that other routes are booby trapped. If the supplies are not added to or taken from regularly, this may indicate that they are being used to bait a trap. By scouting the general area guerrilla forces should guard against surprise by other enemy forces waiting within danger distance.

After making either a raid or an ambush, guerrilla forces should place booby traps behind them to slow up pursuit. Real booby traps can be interspersed with imitation traps. To be safe the enemy will have to go around or de-activate the imitations and take just as much time doing so as if they were real. If the enemy becomes careless in handling your imitation traps, he will run the danger of getting killed by a live one. In planning the path of their retreat guerrilla forces should booby trap alternate routes which enemy forces might use to cut them off.

UNITED STATES GOVERNMENT

# Memorandum

TO : DIRECTOR, FBI (157-23577)

DATE: 1/31/72

FROM : SAC, SAN DIEGO (157-2815)(P)

SUBJECT: SECRET ARMY ORGANIZATION (SAO)  
EM - SAO

*[Handwritten signature]*

Re report of SA STEVEN L. CHRISTENSEN at San Diego dated 1/21/72.

CALIF. MEMBER OF SUBJECT ORGANIZATION

On 1/28/72, ~~██████████~~ advised he had learned during conversation that morning with JERRY LYNN DAVIS, leader of the SAO at San Diego, that the organization had received letters from Newsweek magazine at Los Angeles, California, and from the San Diego Evening Tribune, a daily newspaper. These letters requested interviews with officials of the SAO for the purpose of writing articles in subsequent issues of the respective publications. The letter from Newsweek indicated that magazine was in the process of doing an article on Leftist groups in connection with CALREP, had come across the SAO and wished to include an article on it also.

*[Handwritten initials]*

*[Handwritten initials]*

Source advised that DAVIS is agreeable to the interview with Newsweek with the conditions that the meeting between DAVIS and Newsweek is secure and that the SAO Post Office Box number be printed in the article for additional publicity. DAVIS told source he feels an interview with the Evening Tribune would be premature at this time as he thinks the article resulting from such an interview would be too much of a slap in the face for the San Diego Police Department.

San Diego will follow this matter and advise the Bureau of any additional developments.

- ②-Bureau (RM)
- 4-San Diego (1-170-286)
- (1-100-16200)
- (1-157-██████████)
- (1-157-2815)

REC-45 157-23577-11

JERRY LYNN DAVIS)

SLC:kak  
(6)

FEB 4 1972

EX-100

~~EX. ANT. SEC.~~

60 FEB 14 1972

Buy U.S. Savings Bonds Regularly on the Payroll Savings Plan



UNITED STATES GOVERNMENT

# Memorandum

TO : DIRECTOR, FBI (157-23577)

DATE: 1/31/72

FROM: SAC, OKLAHOMA CITY (157-1133) -RUC-

SUBJECT: SECRET ARMY ORGANIZATION (SAO)  
EXTREMIST MATTERS  
OO: SAN DIEGO

Re Phoenix letters to Bureau, 12/17 and 12/22/71.

**CONF. SOURCE**

advised on 1/25/72, that BURTON currently resides at 813 North Sandusky, Tulsa, Oklahoma, and is self-employed selling coin counting equipment.

During recent contacts with BURTON, there have been no indications that BURTON is currently connected with any extremist organization. agreed to remain alert for and report any information concerning BURTON's possible connection with captioned organization.

**CONF. SOURCE**

REC-60

157-23577-10

EX-100

- 2 Bureau
- 2 San Diego (
- 2 Oklahoma City
- (1 - 157-975, BURTON)

DRE:blh  
(6)

FEB 3 1972

COMMUNICATIONS SECTION

EXT. SEC.



FEB 10 1972

F417

Buy U.S. Savings Bonds Regularly on the Payroll Savings Plan

UNITED STATES GOVERNMENT

# Memorandum

TO : DIRECTOR, FBI

DATE: 2/24/72

FROM : SAC, LAS VEGAS (157-997) (RUC)

SUBJECT: SECRET ARMY ORGANIZATION  
EXTREMIST MATTERS  
OO: SAN DIEGO

~~PHS~~ 9

157-23511-3

Re Las Vegas letter to Bureau, 12/6/71, and Phoenix letter to Bureau, 12/22/71.

All sources and informants cognizant of Minuteman (MM) activity in the Las Vegas Division have been contacted regarding captioned organization with negative results.

Investigation is continuing to determine if JACK CONAN DOYLE, JR., (Las Vegas file 157-553, Bureau file 105-175539) is known to be active in captioned organization. However, it is noted that all sources cognizant of MM activity were contacted regarding DOYLE with negative results.

In the absence of further leads or investigation remaining outstanding Las Vegas is conducting no further investigation in this case since it does not appear that SAO is active in Nevada.

- 2 - Bureau (1 - 105-175539)
- 2 - Kansas City
- 2 - Phoenix (157-1173)
- 2 - San Diego
- 3 - Las Vegas (1 - 157-553)

*Robert Korman*  
*Wm*

WLR:jhp  
(12)

EX-102

REC-11

157-23511-9

FEB 25 30 AM '72  
25 JAN 31 1972

DO NOT WRITE IN THESE SPACES

EXT. SEC.

5 FEB 8 - 1972

UNRECORDED COPY FILED IN 105-175539

LV 157-997

LEADS

PHOENIX DIVISION

AT PHOENIX, ARIZONA

Maintain contact with \_\_\_\_\_ and set forth appropriate leads in the event information is received indicating SAO is active in Nevada or if DOYLE is known to be a member.

SAN DIEGO DIVISION

AT SAN DIEGO, CALIFORNIA

Will through sources determine if SAO is known to be active in Nevada and if DOYLE is a member.

UNITED STATES DEPARTMENT OF JUSTICE

# Memorandum

TO : DIRECTOR, FBI (157-23577)

DATE: 1/24/72

FROM : SAC, KANSAS CITY (157-2179) RUC

SUBJECT: SECRET ARMY ORGANIZATION  
EM - MM  
OO SD

Re Bureau letter to Phoenix 11/9/71.

Indices of Kansas City Office contain no pertinent identifiable information with the Secret Army Organization or individuals mentioned in referenced communication.

The following white hate sources who are generally aware of Minutemen and related activities in the Kansas City, Missouri, area advised on indicated dates they could furnish no information regarding the Secret Army Organization:

[redacted], 12/20/71

[redacted], 1/4/72

[redacted], 1/10/72

ST-110

REC-53

157-23577-8

JAN 27 1972

- 2 Bureau (RM)
  - 2 Phoenix (157-1173)(RM)
  - 2 San Diego (RM)
  - 1 Kansas City
- RBH:jrt  
(7)

EXT. SEC.



FEB 7 1972

Buy U.S. Savings Bonds Regularly on the Payroll Savings Plan

# FEDERAL BUREAU OF INVESTIGATION

REC-2

REPORTING OFFICE <b>SAN DIEGO</b>	OFFICE OF ORIGIN <b>SAN DIEGO</b>	DATE <b>1/21/72</b>	INVESTIGATIVE PERIOD <b>10/8/71 - 1/7/72</b>
TITLE OF CASE <b>SECRET ARMY ORGANIZATION (SAO)</b>		REPORT MADE BY <b>SA STEVEN L. CHRISTENSEN</b>	TYPED BY <b>jam</b>
CHARACTER OF CASE <b>EXTREMIST MATTERS SECRET ARMY ORGANIZATION</b>			

REFERENCE: Phoenix letter to the Bureau and LHM dated 10/22/71;  
 Bureau letter to Phoenix dated 11/9/71;  
 Las Vegas letter to the Bureau dated 12/6/71;  
 Phoenix letter to the Bureau dated 12/17/71;  
 Phoenix letter and LHM to the Bureau dated 12/22/71.

### IDENTITY OF INFORMANTS

It is noted that the large volume of information reported herein was furnished by ~~██████████~~ the sole source

ACCOMPLISHMENTS CLAIMED					<input checked="" type="checkbox"/> NONE	ACQUIT-TALS	CASE HAS BEEN:	
CONVIC.	AUTO.	FUG.	FINES	SAVINGS	RECOVERIES			PENDING OVER ONE YEAR
Deleted Copy Sent <i>Decker Porter</i>							PENDING PROSECUTION OVER SIX MONTHS	<input type="checkbox"/> YES <input checked="" type="checkbox"/> NO

APPROVED *E/O* by Letter *Per FOIA Request* SPECIAL AGENT IN CHARGE

DO NOT WRITE IN SPACES BELOW

COPIES MADE:  
 8 - Bureau (157-23577)  
 (Copies cont'd on Cover Page B)  
 Report declassified by R/S 7/11/75 G.T.T.  
 2 - San Diego (157-2815)

157-23577-7  
 REC-50  
 EX-112  
 EXT. INT. SEC.  
 FEB 23 1972

Dissemination Record of Attached Report			
Agency	ISD, T. DECLASS, ATFD, ACST		
Next Recd.			
Fwd.	R/S		
Fwd.	2/17/72		

Notations



SD 157-2815

Copies Made (cont'd):

- 1 - U.S. Secret Service, San Diego
  - 2 - Baltimore
  - 1 - El Paso (Info)
  - 2 - Kansas City
  - 2 - Las Vegas (157-997)
  - 1 - Los Angeles (Info)
  - 1 - Oklahoma City (Info)
  - 1 - Portland (Info)
  - 1 - Sacramento (Info)
  - 2 - Seattle
- 

of such information in the San Diego Division. Much of this information is known only to the source and to one other individual within the organization. Therefore, in order to afford this source additional security, he has been assigned two T symbol numbers for the purpose of reporting information in the report as follows:

SD T-1 and SD T-2 are

157-2815 (Instant Report)

ADMINISTRATIVE

The identity of HOWARD B. GODFREY is known to the Bureau.

This report is being classified "Confidential" because it contains information from SD T-1 and SD T-2, a confidential source of continuing value to the Bureau in security matters. The unauthorized disclosure of the information contained in the report could reasonably result in the identification of the informant which would be prejudicial to the defense interests of the nation.

- B -  
COVER PAGE

SD 157-2815

All individuals referred to herein as leaders of the SAO in the San Diego area are either being actively investigated or have been so investigated in the past to determine whether they should be placed on the ADEX.

11  
11  
For the additional information of the Bureau and Kansas City, which is Office of Origin in the Minutemen investigation, all individuals associated with the Secret Army Organization (SAO) at San Diego are former members of the Minutemen organization or sympathizers or supporters of that organization. Inasmuch as information contained in this report covers the main areas of Minutemen-type activity within the San Diego area and due to the fact that the individuals who have formed the SAO consider the Minutemen organization to effectively be non-existent, this report is being submitted to Kansas City in lieu of the regular report on Minutemen activity at San Diego.

For the information of the Phoenix Division, [redacted] reported on 11/9/71 that the SAO had received a written request from one CHARLES MANLEVE, 2938 North Seventeen Drive, Phoenix, Arizona, asking for information regarding the SAO.

In connection with its investigation of the individual named JOHN OWEN BURTON as referred to in Las Vegas letter dated 12/6/71 and Phoenix letter dated 12/17/71, Oklahoma City should note that, in early January, 1972, JERRY LYNN DAVIS, SAO leader at San Diego, indicated to SD 1155-E that there were one or more individuals in the State of Oklahoma, exact location not known, who DAVIS referred to as contacts of the SAO.

In addition, it is noted that [redacted] has advised of other contacts of the SAO or written requests for information about the SAO from areas within the Kansas City, El Paso, Baltimore, Los Angeles, Portland, and Sacramento Divisions.

Part II, C., of this report sets forth information regarding an incident in which a young woman, PAULA ELAINE THARP, was injured by sniper fire while at the residence of a San Diego State College professor named PETER GEORGE BOHMER.

- C -  
COVER PAGE

SD 157-2815

Both THARP and BOHMER are subjects of investigation in the San Diego Division on the basis of their activities in the New Left Movement.

BOHMER's residence is a commune known as "The Box," which is a focal point of New Left activity in San Diego and, at this time, is primarily concerned with formulating plans for confrontations and demonstrations during the 1972 Republican National Convention at San Diego. It has been determined that THARP's wound is not serious in nature. , who was present during the incident on an intelligence gathering assignment for the SAO, has identified the assailant as GEORGE M. HOOVER (San Diego 100-15356) who accompanied informant on this assignment. Informant has advised that this incident was not premeditated by the SAO or any member of it, including HOOVER, and that it was a spur of the moment action on HOOVER's part. This information has been disseminated on a confidential basis to the San Diego Police Department, which is investigating the incident.

It is noted that much of the printed literature and propaganda of the SAO has been forwarded to the Bureau via referenced Phoenix communications. However, in order to assure the completeness of this report, one copy of each piece of printed material distributed by the SAO is being included at the end of this report in a section marked "Addendum."

It is noted that details of this report include information dated prior to that of the investigative period. This information is included so as to show a more complete picture of the origin and structure of this organization.

A copy of this report is being disseminated locally to U.S. Secret Service, San Diego, California.

LEADS

EL PASO, LOS ANGELES, OKLAHOMA CITY, PORTLAND, and  
SACRAMENTO DIVISIONS

- D -  
COVER PAGE

SD 157-2815

LEADS (cont'd)

Information copies of this report are being directed to the above offices for their reference and possible investigative assistance in view of the fact that contacts or requests for information regarding the SAO have been reported within those Divisions.

BALTIMORE

Baltimore is requested to furnish San Diego with basic information regarding the group allegedly operated by JESSE CLAYBURN STEVENS and to contact knowledgeable sources regarding this group, to determine the extent of any alliance or connection with the SAO.

LAS VEGAS

AT LAS VEGAS, NEVADA. 1. Will identify ED (LNU), Post Office Box 2191, Las Vegas 89101, telephone number 384-2046, and determine any activities on his part in behalf of the SAO.

2. Will determine if the JACK DOYLE, telephone number 642-4467, referred to in this report is the same as JACK CONAN DOYLE, JR., (Las Vegas 157-553) mentioned in referenced Las Vegas letter to the Bureau.

PHOENIX

AT PHOENIX, ARIZONA. Will identify CHARLES MANLEVE, 2938 North Seventeen Drive, Phoenix, and determine the nature of his activities, if any.

SEATTLE

AT BOTHELL, WASHINGTON. Will identify CY ANDERSON, 10418 N.E. 168th Place, Bothell, and determine the nature of his activities.

SAN DIEGO

- E -

COVER PAGE

SD 157-2815

LEADS (cont'd)

AT SAN DIEGO, CALIFORNIA. Will attempt to identify additional members of the SAO and follow and report activities of this organization.

- F\* -  
COVER PAGE

UNITED STATES DEPARTMENT OF JUSTICE  
FEDERAL BUREAU OF INVESTIGATION

Copy to: 1 - U.S. Secret Service, San Diego

Report of: SA STEVEN L. CHRISTENSEN      Office: SAN DIEGO  
Date: January 21, 1972

Field Office File #: San Diego 157-2815      Bureau File #: 157-23577

Title: SECRET ARMY ORGANIZATION (SAO)

Character: EXTREMIST MATTERS - SECRET ARMY ORGANIZATION

## Synopsis:

Secret Army Organization (SAO) formed at San Diego, California, in late September, 1971, by JERRY LYNN DAVIS to replace Minutemen (MM) organization considered defunct in the San Diego area. Organization formed to provide military-type training for self defense, to oppose communism and totalitarian government, and to take over political power in the United States if the present government fails. JERRY LYNN DAVIS considered "Commander" of the SAO at San Diego and other officers set forth. Members of the SAO active in acquiring and possessing firearms and explosives. Tentative arrangements made for extension of SAO with branches at Las Vegas, Nevada; Phoenix, Arizona; and Seattle, Washington. Additional SAO contacts claimed at Portland, Oregon; El Paso, Texas; Los Angeles, California, and in the States of Kansas and Oklahoma. Contact made with JESSE CLAYBURN STEVENS, alleged leader of East Coast portion of MM organization and tentative arrangements made for alliance between STEVENS' group and SAO. SAO has total of 8 members at San Diego, California, with approximately same number of supporters and sympathizers. Number of possible members or supporters at Las Vegas, Phoenix, and Seattle not known. Membership fees for initiation are

SD 157-2815

\$5.00, monthly dues are \$3.00. Other financial information set forth. SAO to publish monthly news and training bulletin and other special bulletins, posters and stickers as need and occasion arises.

- P -

DETAILS: AT SAN DIEGO, CALIFORNIA

I. ORGANIZATIONAL STRUCTURE

A. Location of Headquarters

On May 5, 1971, it was reported that JERRY LYNN DAVIS, leader of the SAO, in laying plans for the formation of the organization, wanted it to appear in several cities at the same time. However, the headquarters would be at San Diego, California.

(SD T-1, May 5, 1971)

On September 13, 1971, it was reported that, in preparation for future organizational work, DAVIS had rented several Post Office boxes in the San Diego area which would be used for this purpose. These included Post Office Box 5791, San Diego, California 92105, which was rented in DAVIS' name, and Post Office Box 503, Lemon Grove, California 92045, which was rented in the name of "Artist Supply." It was reported that "Artist Supply" was the name utilized for a mail drop operated by TROY HAUGHTON, former West Coast leader of the Minutemen (MM) organization.

(SD T-1, September 13, 1971)

The Minutemen (MM) is a paramilitant group organized in June, 1960, by ROBERT B. DE PUGH in Norborne, Missouri, as a resistance to the

- 2 -

spread of communism in the United States by use of guerrilla tactics. DE PUGH is currently incarcerated in a Federal penitentiary for violation of the Federal Firearms Act.

The Patriotic Party has been the political arm of the Minutemen.

On January 7, 1972, it was reported that the organization has no formal headquarters and that it is operated out of the homes of JERRY LYNN DAVIS and other members.

*aka. Patrick McDonald*

*Leader of "Secret Army Organization"*  
(SD T-2, January 7, 1972)

*Add: 2393 Washington, Spring Valley, Calif*

B. Charter Information

On January 7, 1972, it was reported that the SAO has no plans for formulating charters as such for the parent or subsidiary groups.

*AR 121  
10X05  
A111*

(SD T-2, January 7, 1972)

C. Objectives

On May 5, 1971, it was reported that JERRY LYNN DAVIS was highly interested in forming a new Right Wing group to organize people in various localities and to provide them with military-type training for the purpose of being ready to eventually take over political power in the United States when the present government fails due to oppression or communist influence.

(SD T-1, May 5, 1971)

On December 20, 1971, it was reported that, in correspondence with another similar group, DAVIS stated that, although the SAO was a new organization with a new name, it



SD 157-2815

would continue to adhere to the tenets and principles of the old MM organization.

(SD T-1; December 20, 1971)

On January 7, 1972, it was reported that the SAO intended to conduct intelligence-type operations and to offer training in urban guerrilla warfare to be used against Left Wing groups and suspected enemies of the United States.

A leaflet entitled, "Join the Secret Army Organization" was made available which offered the following statements of purpose:

- 1) To prepare the means of personal defense and survival in case of enemy attack.
- 2) To resist and expose the spread of communist influence and propaganda within our own national boundaries.
- 3) To investigate by means of our own secret memberships the infiltration of communist sympathizers into American organizations of government, business, labor, religion and education.
- 4) To resist by any and all means the passage of laws which regulate the private ownership of firearms or which detract from the individual's ability to defend his own family and personal property.
- 5) To promote knowledge and skill in the use of arms by our own members and by the general public.
- 6) To form in advance of actual need a secret underground organization equipped to spy upon, harass and destroy troops of any foreign power that might occupy United States territory.

SD 157-2815

7) To lend assistance and support wherever possible to other resistance organizations, domestic or foreign, opposing communist expansion or subversion.

8) To pursue these programs as private citizens motivated only by patriotism and to remain entirely free of government subsidies or control."

(SD T-2, January 7, 1972)

D. Officers

On January 7, 1972, it was reported that, if the organization continues to progress as originally envisioned, it will eventually be operated by a General Staff. This General Staff will be composed of JERRY LYNN DAVIS, 2393 Washington, Spring Valley, California, with the title of "Commander," and the leaders of various area groups who will hold the title of "Captain." At the present time, such area groups tentatively exist in the following places:

San Diego, California  
with the "Captain" being HOWARD B. GODFREY  
746 Graves  
El Cajon, California

GODFREY is a former MM and will be Number Two man in the SAO.

Phoenix, Arizona  
where the "Captains" will be EVERETT MOORE  
and his wife. The MOORES are known MM leaders in the Phoenix area.

Seattle, Washington  
where the "Captain" will be CY ANDERSON  
10418 N.E. 168th Place  
Bothell, Washington

SD 157-2815

Las Vegas, Nevada  
where the "Captains" will be ~~JACK DOYLE~~ and  
ED (LNU)

Post Office Box 2191  
Las Vegas, Nevada

-These individuals allegedly have former  
connections with the MM organization.

(SD T-2, January 7, 1972)

E. Summary of Overall Activities

On May 5, 1971, it was reported that JERRY LYNN DAVIS was continually talking about the plans he was making to start a new organization. According to DAVIS, he considered the MM organization to be defunct, at least in the San Diego area and in most of the Western states, and felt the need to organize a new Right Wing group to fill the power vacuum which it had left. He indicated that he knew people in Phoenix, Arizona; Portland, Oregon; Seattle, Washington, and Las Vegas, Nevada, who he wanted to contact regarding such an organization, feeling that they would be highly interested in helping to organize and get it going. He said his plans included having Post Office boxes rented for the new organization in all these cities and having leaflets and stickers regarding the organization printed using the respective Post Office box numbers. On a pre-determined day, press releases would be made in each of these cities announcing the formation of the organization with the leaflets and stickers being put up in the cities on the same day. This would be done for the purpose of disguising the location of the national headquarters, which would be actually located in San Diego, California.

(SD T-1, May 5, 1971)

On September 13, 1971, it was reported that DAVIS had become very interested in the National Socialist White Peoples Party (NSWPP) as a possible answer to the need for a

SD 157-2815

Right Wing group in the San Diego area. He was reportedly studying that organization and considering becoming a member.

(SD T-2, September 13, 1971)

The National Socialist White Peoples Party, also known as The American Nazi Party, American Nazis, and The George Lincoln Rockwell Party, was organized on February 26, 1956, at Arlington, Virginia, based upon the concept of an international "National Socialist" movement as espoused by the German Nazi Party headed by Adolf Hitler. The organization supports and follows the line of hatred against Negroes, Jews, and communists through various propaganda media seeking a legitimate dominant political party in the United States and foreign countries.

On September 16, <sup>1971</sup>, it was reported that, while very interested in the NSWPP, DAVIS was still considering going ahead with plans for the new organization. In addition, DAVIS indicated that he expected to obtain membership lists and the necessary materials for setting up application forms, bulletins and training literature for the new organization from ~~BETHE HAUGHTON~~, wife of ~~TROY HAUGHTON~~. DAVIS said he would attempt to have the bulletins, training materials, and membership application forms printed in the near future and that, tentatively, the responsibility for making the monthly mail-outs would alternate between DAVIS and GODFREY. DAVIS advised that O. A. ALEXANDER of Alex Rapid Print, 7609 El Cajon Boulevard, La Mesa, California, had agreed to print some of these materials. ALEXANDER was described as a former MM supporter who had allowed TROY HAUGHTON to use his printing facilities for the benefit of the West Coast MM organization.

Other plans for the new organization included eventually setting up two membership lists which would be recorded on microfilm. One of the lists would be maintained by DAVIS and the other by GODFREY. The purpose in placing

SD 157-2815

the membership lists on microfilm was for easy destruction. Two lists were to be maintained to guard against the possibility of one being lost or destroyed.

(SD T-2, September 16, 1971)

On October 8, 1971, it was reported that DAVIS had chosen the name "Secret Army Organization" for his new group. In addition, it was learned DAVIS had had 1,000 copies each of letterhead stationery and membership application forms for the SAO printed up the previous weekend. DAVIS also advised that he, GODFREY, and other associates would attend the Annual Yuma Gun Show at Yuma, Arizona, on October 16 and October 17, 1971, at which time he expected contact would be made with people attending the gun show from Phoenix, Arizona, and Seattle, Washington, regarding the SAO.

(SD T-1, October 8, 1971)

On October 16, and October 17, 1971, DAVIS, GODFREY, and STANLEY DON MC DADE, a prospective member of the SAO residing at 4114 Massachusetts, La Mesa, California, were in attendance at the Yuma Gun Show. Following the gun show, a meeting was held in a motel room at Yuma, Arizona, with persons in attendance, including the above three individuals and EVERETT MOORE and his wife from Phoenix, Arizona, and CY ANDERSON from Seattle, Washington. The topic of discussion was the SAO and those attending the meeting were in general agreement that a new cohesive force was necessary among Right Wing groups as a result of the power vacuum left by the disintegration of the MM organization. MOORE and ANDERSON tentatively agreed to having their respective groups join the SAO subject to the approval of the members of these groups. Copies of printed material of the SAO, including a leaflet entitled, "History of the Secret Army Organization," a copy of the first bulletin of the SAO entitled, "To Prospective Members of the Secret Army Organization," and membership application forms were passed around among the group.

It was decided that subsequent contacts regarding expansion of the SAO would be made and that the San Diego area

SD 157-2815

mail drop for the Phoenix group would be the address of HOWARD FRANCIS CLARK, 1080 6th Street, Ramona, California, a former member of the MM organization.

En route to the gun show, CY ANDERSON's automobile had broken down some place in the State of Nevada and it had been necessary for him to hire transportation from there to the gun show. After the gun show, DAVIS drove to Las Vegas, Nevada, accompanied by ANDERSON, to make contact with people known to him regarding the SAO.

It was reported that DAVIS, who is part American Indian, had abandoned the idea of joining the NSWPP when he learned in late September, 1971, that the NSWPP is adamantly opposed to persons having American Indian blood, considering them to be of an inferior race. It was felt that this fact was responsible for DAVIS' decision to finally go ahead and organize the SAO.

It was also reported that, in addition to the letterhead stationery and application forms, several thousand copies of the history leaflet and the first bulletin had also been printed at the same time as well as a number of stickers advertising for the SAO. The printing of these materials was done by BETTIE HAUGHTON on an offset press which she had maintained since the time her husband was in the MM organization. Many copies of these printed materials have been sent out to people known in the past to have been MM members or other Right Wing sympathizers.

The meeting mentioned in the first paragraph of the history leaflet is actually a disguised reference to the meeting which took place in the motel room at Yuma, Arizona, on October 17, 1971.

(SD T-2, October 20, 1971)

DAVIS returned home from Las Vegas, Nevada, on the evening of October 23, 1971. He stated that the reason for this delay was that he had become very involved in Las Vegas with meeting people and with organizing the SAO indicating

SD 157-2815

that arrangements had been made for the group he contacted at Las Vegas to join the SAO. He further advised that arrangements had been made to get insignia patches from CY ANDERSON for the berets that SAO members would be given to wear.

(SD T-2, October 26, 1971)

On October 27, 1971, DAVIS was reported to have advised that ANDERSON had gone to El Paso, Texas, from Las Vegas, Nevada, to make contact with people known to him there. DAVIS advised he expected ANDERSON to be in San Diego on October 29, 1971, for additional discussions regarding the organizing of the SAO. DAVIS said he also felt the need for him and GODFREY to travel to Phoenix, Arizona, sometime in December, 1971, for the purpose of recontacting EVERETT MOORE regarding the SAO.

(SD T-2, October 27, 1971)

On November 9, 1971, it was reported that CY ANDERSON had spent approximately a day and a half at DAVIS' residence discussing the SAO. Resulting from these discussions were tentative plans for a trip during December, 1971, or January, 1972, during which DAVIS and ANDERSON would travel through Arizona to El Paso, Texas, following which they would cross the border at Juarez, Mexico, and drive to Mexico City. Returning from Mexico City, they would travel to Las Vegas where the individual named ED (Last Name Unknown) would be picked up and who would then travel with them to Denver, Colorado, and the State of Montana. The purpose of the trip would be to contact people regarding expansion of the SAO and to solicit support for that organization.

(SD T-2, November 9, 1971)

On December 17, 1971, correspondence was observed at the DAVIS residence from an individual named JESSE CLAYBURN STEVENS at Silver Springs, Maryland. The correspondence, which

SD 157-2815

was addressed to the SAO, indicated that STEVENS was in control of at least part of what was left of the former MM organization on the East Coast. In the letter, STEVENS expressed hatred for ROBERT BOLIVAR DE PUGH, former national leader of the MM organization, and interest in establishing future contact with the SAO. STEVENS also indicated that he corresponded with several individuals in the San Diego area and did not know who had furnished him information on the SAO. According to DAVIS, this was done by STANLEY DON MC DADE. In addition, DAVIS advised he is known to STEVENS by the alias of PATRICK MC DONALD.

A letter replying to the above correspondence from STEVENS which DAVIS had written was also observed. In this letter, DAVIS also expressed interest in making contact with STEVENS' group. DAVIS indicated in his letter that, even though the SAO was a new organization with a new name, it would continue to adhere to the tenets and principles of the old MM organization.

(SD T-1, December 20, 1971)

On December 20, 1971, the SAO distributed several hundred copies of a special intelligence bulletin which it had prepared regarding PETER GEORGE BOHMER, a professor of Economics at San Diego State College, and a well-known figure in New Left activities in the San Diego area. The information contained in the bulletin was obtained by the SAO primarily from research of newspaper articles and surveillance of BOHMER's activities.

(SD T-1, December 20, 1971)

On December 29, 1971, it was reported that DAVIS had received additional correspondence from JESSE CLAYBURN STEVENS. In this letter, STEVENS agreed to the formation of an alliance between his group and the SAO. Guidelines which were set up would have STEVENS' group in control of Right Wing activities in the East and in the South, while the SAO would operate in the Western states. It was also agreed that the two groups should work on finding an individual in or near Chicago,



SD 157-2815

Illinois, to act as coordinator of Right Wing activities in the Midwest area. DAVIS mentioned JAMES EVAN POTO as a good possibility in this regard. POTO, an SAO member at San Diego, is employed by a national restaurant chain and is expecting to be transferred to the Chicago area in the early part of 1972 to open a new restaurant there. *John*

In addition, arrangements were made between SAO and STEVENS' group regarding the trading of information on individuals of interest to these organizations who reside in each other's areas. Furthermore, it was agreed that members of their respective groups would be transferred from one group to another if they should move to a new area.

STEVENS indicated that his group has microfilming equipment and "secure" messages between the two groups will be transmitted by microfilm as soon as the SAO acquires the necessary equipment.

(SD T-1, December 29, 1971)

On December 29, 1971, it was reported that BETTIE HAUGHTON will remarry in the near future and, upon doing so, expects to leave the San Diego area. At that time, she will give the offset press, which she has, to the SAO for its use.

DAVIS has been very busy recently preparing the next SAO bulletin. According to what he has said, this bulletin will contain eight pages of technical information dealing with explosives, booby traps and other weapons and will have two pages of general information regarding news, recruiting, and training.

(SD T-2, December 29, 1971)

On January 5, 1972, it was reported that the new SAO bulletin had been printed and was ready for distribution. In addition, DAVIS was reported to have stated that he wanted to

SD 157-2815

begin work on a new special bulletin such as the one done by the SAO on PETER GEORGE BOHMER. However, this time the target of the bulletin would be a nationally-known figure of the New Left Movement.

(SD T-1, January 5, 1972)

F. Acquisition of Firearms and Explosives

On January 7, 1972, it was reported that most members of the SAO possess several firearms and frequently are armed. Furthermore, members of the SAO are endeavoring to acquire explosives and munitions of all descriptions.

(SD T-2, January 7, 1972)

II. ACTIVITIES OF LOCAL GROUPS

A. Name, Location, and Estimated Membership

On January 7, 1972, it was reported the SAO leadership considers that the organization has groups established at the following locations:

San Diego, California

The group at San Diego controls the State of California and has the same location as the national headquarters. This group has eight members and approximately the same number of prospective members and supporters.

Phoenix, Arizona

The Phoenix group controls the State of Arizona. There are only two individuals, EVERETT MORRE and his wife, known at this time, although, allegedly, a larger groups exists.

*Moore*

SD 157-2815

Seattle, Washington

This group controls the State of Washington and possibly Idaho and Oregon as well. Contact with only one individual, CY ANDERSON, is known, although a larger group allegedly exists.

Las Vegas, Nevada

This group controls the State of Nevada with at least two individuals, JACK DOYLE and ED (Last Name Unknown) and possibly more in the group.

In addition, DAVIS has claimed to have two members, names not known, at Carson, near Los Angeles, California, and to have made contact regarding the SAO with acquaintances in the States of Oklahoma and Kansas.

Furthermore, DAVIS has advised that individuals near Redding, California, and in the State of Maryland have written in requesting information on the SAO.

(SD T-2, January 7, 1972)

B. Officers

On January 7, 1972, it was reported that, for the time being, officers of local groups of the SAO will be the same as those listed for national and state positions of the SAO.

(SD T-2, January 7, 1972)

C. Summary of Activities

It is noted that most of the information regarding activities of the SAO at San Diego has been reported in the

SD 157-2815

section entitled "Overall Activities" in order to more easily show the organization and growth of the group.

On January 7, 1972, an article appeared in the San Diego Union, daily newspaper at San Diego, California, and reported that, on the previous evening, a young woman at the residence of PETER GEORGE BOHMER had been wounded by sniper fire from an unknown assailant. According to the article, stickers regarding the SAO had been placed on the door of BOHMER's office at San Diego State College earlier that day and BOHMER had allegedly received threatening telephone calls from the SAO.

The article stated that the San Diego Police Department was investigating the incident.

On January 7, 1972, Detective ERNIE TRUMPER, Investigative Support Division, San Diego Police Department, advised that a witness at the scene of the shooting incident had described seeing two shots fired from a light blue 1964 Plymouth Valiant automobile. According to TRUMPER, the individual firing the shots had been described as a white male in his middle 20's, slender build, with dark curly hair and a light, neatly trimmed beard.

On January 7, 1972, it was reported that members of the SAO had indeed placed stickers on BOHMER's office door during the day on January 6, 1972. However, it was reported that the description of the vehicle and the assailant as furnished by the San Diego Police Department did not match any known SAO member or vehicle belonging to any SAO member.

(SD T-2, January 7, 1972)

### III. FINANCES

On September 16, 1971, JERRY LYNN DAVIS was reported to have stated that he estimated the monthly operating cost of the organization he had in mind to be approximately \$100.00.

SD 157-2815

He further advised that O. A. ALEXANDER of Alex Rapid Print had agreed to do printing for the SAO at cost.

(SD T-2, September 16, 1971)

On October 8, 1971, it was reported that initiation fees in the SAO would be \$5.00 and that monthly dues of membership would be \$3.00.

(SD T-1, October 8, 1971)

On November 26, 1971, DAVIS was reported to have stated that he had spent \$300 of his own money on printing materials for the SAO and for other expenses.

(SD T-1, November 26, 1971)

On December 20, 1971, it was reported that the SAO had then spent \$140 on printing its literature. The last bulletin put out by the group had been done at Alex Rapid Print at a cost of \$3.50 for 200 copies. A total of \$16.00 was spent on stamps to mail the bulletin out.

(SD T-2, December 20, 1971)

#### IV. PUBLICATIONS AND PROPAGANDA

On January 7, 1972, it was reported that present plans of the SAO call for putting out a monthly bulletin for members of the group and for other special bulletins, leaflets, posters and stickers as the need and occasion arises. Future plans call for the eventual publication of a bulletin which will be distributed publicly.

The SAO is presently contemplating using the slogan "We're Everywhere."

(SD T-2, January 7, 1972)

SD 157-2815

V. MISCELLANEOUS

Included at the end of this report as a special section marked "Addendum" is one copy of each piece of literature printed so far by the SAO.

This document contains neither recommendations nor conclusions of the FBI. It is the property of the FBI and is loaned to your agency; it and its contents are not to be distributed outside your agency.

SD 157-2815

ADDENDUM

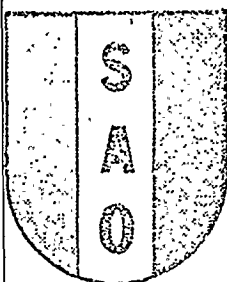

**SECRET ARMY ORGANIZATION**  
GENERAL HEADQUARTERS

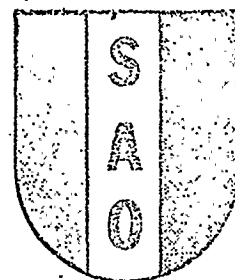

Dear Fellow American,

At the request of a mutual friend we are sending you this invitation to join the Secret Army Organization. Those of us who have been members for some time sincerely believe that our organization can be of real value in preserving for future generations the land of freedom and opportunity which our forefathers handed down to us.

It is the belief of our organization that the communist-socialist conspiracy has infiltrated the United States Government to such an extent that the American people cannot rely on this country's elected leaders to protect them from communist domination and slavery.

We believe that the time will come when the American people will have to fight for their lives and their liberty. In this belief, we have formed in advance a secret underground army with but one objective, to defend our constitutional republic and to help our fellow Americans to do the same.

We do not want lukewarm members. We are an organization of people willing to make any sacrifice necessary for our country. If you feel the same way, we invite you to join us.

SECRET ARMY ORGANIZATION





SECRET ARMY ORGANIZATION

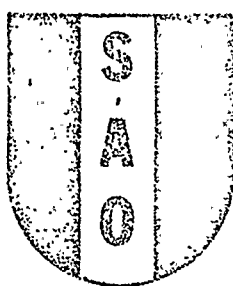

GENERAL HEADQUARTERS

Dear Fellow American,

Your letter of inquiry concerning the Secret Army Organization was received a few days ago. We have had so many inquiries during the past few months that it has been impossible to answer each of them promptly with a personal letter.

We certainly appreciate your interest in our organization and we hope you will join us in our battle for national and individual freedom. As you learn more about the Secret Army Organization I'm sure you will come to realize that we are not radicals, but are far more inclined to be quietly dedicated and clear thinking individuals.

Enclosed is some further information about our organization, its history, objectives and programs. After you have given this material careful study, we hope you will use the enclosed application form to join our organization. When sending in your application, do not put your return address or name on the outside of the envelope.

After your membership application has been processed, we would certainly welcome having you work with one of our local units, or better still, help you organize your own unit with our assistance after you have completed preliminary training.

Sincerely yours,

Captain Patrick McDonald  
S. A. O. Headquarters Staff

# History of the Secret Army Organization

One early morning in February, 1970, a group of six Minutemen leaders from four states met secretly in Northern Arizona to discuss the crisis that the arrest and imprisonment of two top Minutemen leaders and the assassination of a third had brought on the organization. Although some of these men had met before in their roles as Minutemen group leaders, others were meeting for the first time.

After much discussion, two principal points were agreed upon. First, that the Minutemen as a national coordination organization of militant right-wing groups had effectively been destroyed by the pro-communist elements inside the Justice Department. While individual units still existed throughout the country, few had the financial support or leadership to be really effective. Second, that the need for such a coordinating organization was greater than ever in view of the increased revolutionary activity by communists in the United States.

With these two points in mind, suggestions were put forward on a course of action to be followed. After a meeting that lasted all that day and far into the next morning, an overall plan of action was finally agreed upon. All present agreed to merge their individual units together and form a new organization under the command of one leader elected from among themselves, with the other five to be members of a General Staff that would advise and assist the new leader.

While retaining the basic programs and policies of the Minutemen, it was decided that not only should this new organization have a different name, but also a completely new chain of command and organizational structure. If the new organization was going to survive the attacks that befell the old one, a whole new approach would be needed. Never again could the arrest or death of a few leaders be allowed to cripple the entire organization.

For this reason it was decided that only a highly disciplined military type organization with a definite chain of command would have any chance of success. This then, was the beginning of the Secret Army Organization. Beginning with an original force of hard core patriots that numbered fewer than two hundred, the Secret Army Organization began the job of picking up the pieces and continuing to fight for national and individual freedom. Using this cadre of dedicated personnel as a nucleus, the S. A. O. has been recruiting and training new members in the skills they will need as the freedom fighters of tomorrow.

The leaders of the S. A. O. have no idea of fighting a last ditch stand. We have no desire to commit suicide ourselves or to let our members do so. We have a strategy which we believe will ultimately lead to victory. Only one thing is essential. We must start preparing and training NOW! We of the S. A. O. believe that our country is worthy of any sacrifice. If you feel the same way, we invite you to join us.

# JOIN THE SECRET ARMY ORGANIZATION

*An organization of loyal Americans  
dedicated to the preservation of both  
national and individual freedom.*

1. To prepare the means of personal defense and survival in case of enemy attack.
2. To resist and expose the spread of communist influence and propaganda within our own national boundaries.
3. To investigate by means of our own secret memberships the infiltration of communist sympathizers into American organizations of government, business, labor, religion and education.
4. To resist by any and all means the passage of laws which regulate the private ownership of firearms or which detract from the individual's ability to defend his own family and personal property.
5. To promote knowledge and skill in the use of arms by our own members and by the general public.
6. To form in advance of actual need a secret underground organization equipped to spy upon, harrass and destroy troops of any foreign power that might occupy United States territory.
7. To lend assistance and support wherever possible to other resistance organizations, domestic or foreign, opposing communist expansion or subversion.
8. To pursue these programs as private citizens motivated only by patriotism and to remain entirely free of government subsidies or control.

The Secret Army Organization is a national organization of patriotic Americans who are preparing themselves as a last line of defense against communism. To exemplify the necessity of such an organization, we quote the 1960 Annual Report of the Committee on Un-American Activities as follows:

"Events of the past year have provided convincing evidence that the American people cannot rely completely on this country's armed forces to protect themselves from communist domination and slavery. This is not because our military forces lack the power or the will to defend this country, but rather because the nature of the attacks being made on the United States by its major and only significant enemy are so designed as to render conventional military forces as ineffective as possible for defense purposes."

Starting from nothing 50 years ago, communism now rigidly controls one-third of the human race and has subverted to varying degrees the remaining two-thirds. In the past 20 years the communists have conquered 20 sovereign nations, one by armed conquest and 19 by internal subversion or negotiation.

There is not one of these countries in which the communists rule by the consent of the people. Everywhere they must perpetuate themselves by terror. They remain in power only through the use of the most brutal police state tactics.

The communists consider their party workers not simply as an accessory to armed conquest but as the actual spearhead of any invasion into new territory. From this point of view the United States was "invaded" by Soviet troops more than 30 years ago. It has been authoritatively estimated that the communists now have an army of 500,000 combatants already landed on American shores and already working by the most insidious means to destroy our American way of life.

The cold war is very real. It must be fought and won. The only alternative is to lose and to lose means that future Americans for generations to come must live in terror and in slavery. Appeasement is futile. We cannot bargain with moral barbarians who never have and never will know the meaning of honesty.

Communism must be defeated, not merely resisted. We must rid our country of traitors and fellow travelers. We must embark on a massive offensive turning every communist trick - from propaganda to infiltration - against our mortal enemy. This is the one and only way to win the struggle for survival.

Send 20¢ in coin or stamps for full information on the Secret Army Organization programs and membership application to: S. A. O., P. O. Box 5791, San Diego, California 92105.

23

To Prospective Members Of The  
SECRET ARMY ORGANIZATION

The Secret Army Organization is the most active, most completely dedicated and most selective in its membership of all the many patriotic organizations in America. We are willing to make any sacrifice for our country and we fully expect that some of us will have to make the ultimate sacrifice before victory is achieved. Our very lives depend on each other. There is no place in this organization for bunglers, playboys or lukewarm conservatives. If you join the Secret Army Organization, there might easily come a time that your life would depend on how competently some other member had learned his job.

Unless you are especially well informed on the domestic and world political situation, it is probable that you have a lot to learn about the present threat our nation faces. Unless you have had many years experience in actual underground warfare, there is undoubtedly a lot you can learn from the experts in our organization who have developed and supervised our training program.

OUR NATION IS IN IMMEDIATE DANGER

It is possible that within a very few years, perhaps even within months, our nation could be conquered and enslaved by the communists. To prevent this we must know as much as possible about our enemies. Unless we know who they are and what they are doing we will not succeed in our efforts to maintain a free America.

THE RESISTANCE MOVEMENT

In driving an invader from your land the resistance involved goes through three stages of development.

- 1) The Underground Network
- 2) Active Guerrilla Warfare
- 3) Open or Conventional Warfare

The conventional warfare stage uses everything in the way of weapons that the enemy does but must also have active guerrillas and underground agents working against the enemy, too. In the present state of military tactics conventional warfare cannot succeed unless these other two ingredients are used simultaneously.

The first step is to form an underground network. An active guerrilla system must have the support of an underground network of approximately three times its own size. This underground must supply the active guerrilla fighter with supplies, concealment, information, etc. An underground network starts with departments of intelligence, security and propaganda in that order.

Sabotage, espionage, subversion, infiltration, escape and evasion, training, clandestine fabrication of supplies, counterfeiting enemy documents, recruiting, communications and propaganda are other phases of underground activity. Each member of the Secret Army Organization, to be effective, must have a working knowledge of all these tactics as well as the military tactics more commonly associated with guerrilla activities.

## ASSIGNMENT TO UNITS

Many people that inquire about membership in the Secret Army Organization seem to have an idea that they will be immediately accepted into an active unit. Look at it this way. Suppose you had spent a year or more carefully recruiting and training until you had a hard hitting team where every individual was reliable, dedicated, and had confidence in his fellow unit members. Wouldn't it make you mad to have the national or regional organization assign some rank amateur to your unit that you you knew little or nothing about?

Before any new member is assigned to an active unit or to an important underground project, he must undergo a period of training. During this training he will be directed through the mails by an experienced member and some of his activities may be observed by other members without his knowledge. Only when a new member proves himself to be conscientious, trustworthy, self-disciplined and able to operate effectively alone will he be accepted as a "secure member" and invited to participate with other unit members in a teamwork operation.

## EXPENSES

Unfortunately, most good things don't come cheap. Although we make every effort to keep down the expense of membership in the Secret Army Organization, you must expect to pay your own way.

Dues to the Secret Army Organization are \$3.00 per month. This money is absolutely necessary for use to maintain our central files and headquarters, for postage and printing, to finance our extensive intelligence network, and to maintain training areas.

Each member will have other expenses depending on the type of activity he is engaged in. Every member will be expected to buy his own gun, ammunition and other basic combat equipment. During training the new member may be expected to buy certain books or subscribe to certain magazines that his work requires. During this time the new member will also be supplied with reading material on the strategy and tactics of guerrilla warfare. This home work will make it possible for him to fit in quickly to an active unit and participate effectively in actual maneuvers, marksmanship training, etc.

Following this preliminary training a member may be either assigned to an existing unit, assisted in organizing his own unit if he has shown sufficient leadership qualities or become part of an underground network.

Upon your acceptance into the Secret Army Organization you will be given a definite series of projects described in writing so you will know exactly what will be expected of you.

We hope that you can succeed in this effort because your country desperately needs patriots at this time.

25

Secret Army Organization

# APPLICATION FOR MEMBERSHIP

NOTICE TO APPLICANT: All information on this form will be kept confidential. All records of members of the Secret Army Organization are stored in a way that they can be swiftly destroyed to keep them from falling into unauthorized hands.

Name \_\_\_\_\_ Sex \_\_\_\_\_ Age \_\_\_\_\_

Address \_\_\_\_\_ Marital Status \_\_\_\_\_  
(Street)

State \_\_\_\_\_ Wife's Name \_\_\_\_\_

Zip Code \_\_\_\_\_ Telephone \_\_\_\_\_

Date of Birth \_\_\_\_\_  
(Month) (Day) (Year)

Occupation \_\_\_\_\_ Education \_\_\_\_\_

Special Subjects Studied \_\_\_\_\_

Do You Speak or Read Any Foreign Language? \_\_\_\_\_

Veteran \_\_\_\_\_ Branch \_\_\_\_\_ Highest Rank \_\_\_\_\_

What Service Training Have You Had That You Feel Would Be Beneficial To This Organization? \_\_\_\_\_

Physical Description: Height \_\_\_\_\_ Weight \_\_\_\_\_ Color Eyes \_\_\_\_\_

Color Hair \_\_\_\_\_ Health: Good \_\_\_\_\_ Fair \_\_\_\_\_ Poor \_\_\_\_\_

Any Physical Disabilities or Limitations? \_\_\_\_\_

Any Public Speaking or Organizing Experience? \_\_\_\_\_ If Yes, Please Explain: \_\_\_\_\_

How Many Hours A Week Could You Devote To Working And Training With the S. A. O. ?

Hours \_\_\_\_\_ Best Time: AM \_\_\_\_\_ PM \_\_\_\_\_ Weekdays \_\_\_\_\_ Weekends \_\_\_\_\_

## CERTIFICATION

I am a loyal American Citizen dedicated to the defense and survival of the United States as a Constitutional Republic, free from all socialist and communist policies. Enclosed is my \$5.00 membership fee. I agree to pay \$3.00 each month to the Secret Army Organization as membership dues.



SECRET ARMY ORGANIZATION



GENERAL HEADQUARTERS

Dear Fellow American,

Your application for membership in the Secret Army Organization has been processed and approved. It is our profound hope that your membership in the S. A. O. will prove to be a benefit to the organization and yourself as well. A dedicated member will find that his association with our organization is a way of life that is far more rewarding than the ordinary mediocre existence of his fellow enlightened citizens.

For security purposes all records regarding individual members are listed by numbers only. Your number will be \_\_\_\_\_. Please sign all future correspondence addressed to the organization with this number. You need not list your address unless it is different from the one in our records.

Another security measure employed by our organization is the use of mail drops. The mail drop is an address listed in a fictitious name of a person or company not connected with the organization. Each member is assigned one that he will use in sending all reports, correspondence, materials, etc., to the organization. Your assigned mail drop is:

We have a tremendous job ahead of us. Certainly, none of us pretend to know what the future holds for ourselves or for our native land. We do feel, however, that our freedom is gravely threatened. It is not always possible to know the best thing to do. But we do know this - our forefathers have given us a life of freedom and opportunity such as never existed before in all history. We must strive to pass this heritage on to future generations intact.

Our organization is not suggesting or doing anything more than Americans have always done - starting in 1776.

Enclosed is some further information about our organization, its history, objectives, and programs. Your record has been turned over to our training section and you should receive your first training program within two weeks.

Sincerely yours,

27  
Captain Patrick McDonald  
S. A. O. Headquarters Staff



# THE COMBAT TEAM

## General Outline

The "Combat Team" is the smallest organizational unit used by the Secret Army Organization. When organized in the proper manner it is capable of operational initiative when detached from the parent organization. When developed to its highest degree of efficiency the Combat Team is almost totally self-sufficient and able to perform any one of several missions. To attain these aims the following elements are essential:

- a. Equipment should be well-chosen and standardized as much as possible.
- b. Communications, internal and external, must be capable of rapid transmission, be varied in nature, and be exercised with prime emphasis on security.
- c. Internal coordination should be automatic in response. Confidence among members of the team must be developed.
- d. Selection of each position on the team should be based on psychological aspects as well as technical competence.
- e. Training of the men in each function should be at regular intervals and continuous. Field problems should be given dry runs in detail.
- f. The logistics problem should be studied with care, and made simple and direct.
- g. Each team will have a "leader" (Lieutenant) and an "assistant leader" (Sergeant). These men shall be given special training by the Secret Army Organization at "leadership seminars".
- h. Team "marshalling points" should be selected in advance and be well defined. Practice "alerts" will determine the team's efficiency in response and security.
- i. Terrain familiarity within the expected operational radius of the team must be developed.
- j. Weapons familiarity must be obtained through live firings at various targets. Team action must be stressed as well as individual competence.
- k. The team leader should see that a constant flow of information is provided to team members on the ideological struggle. This will help induce the proper frame of mind in each member.
- l. Team missions and targets must be identified and the proper training equipment made available for each assignment.

- m. The team leaders will be responsible for maintaining the overall security of the unit. Personal feelings should not affect decisions involving reprimand or dismissal of men from the team for reasons that endanger its operation or security.
- n. Intelligence gathering as an important part of each team member's duties should be stressed. Information on the location and movements of local communist and left-wing enemies of the organization should be sent to either Regional or General Headquarters.
- o. The team leaders will be responsible for maintaining contact with higher command and for the transmission of orders from same.

### ORGANIZATION

The "Combat Team" will consist of six men. These six men will be divided into two sub-teams (Sections). Number One Section will consist of the Team Lieutenant and two other team members. Number Two Section will consist of the Team Sergeant and the two remaining team members. When completely assembled the unit will act directly under the command of the Team Lieutenant. When split into sections the Team Sergeant will carry out the orders of the Team Lieutenant during missions but will be in immediate command of the Number Two Section. In the absence of the Team Lieutenant the Sergeant will take command of the Unit.

### TRANSPORTATION

Transportation of the Combat Team will be effected by the use of two carriers. Interception and/or destruction of one carrier will not, then, immobilize the team. In addition, each carrier can serve as a scouting element for the other. Motorized carriers should be as inconspicuous as possible and still serve their purpose. Jeeps and pickup trucks should be used only where such vehicles are owned and used commonly by the general population or where the terrain makes their use necessary. Most often an ordinary passenger car will suffice. The model selected should have a good road clearance so it can be used on dirt roads. Tire chains (if needed), hydraulic jacks, extra gas, water, and suitable tools should be stored in the vehicle.

### TRAVEL PROCEDURES

Underway, Carrier #1 will lead and Carrier #2 will trail. The "interval" will vary with conditions. In cities close-aboard trailing will be used. Open road, by day, will require an interval of approximately 300 yards. At night this will be reduced to approximately 100 yards. During travel, all equipment (especially arms and ammunition) should be kept out of sight. Special team equipment and weapons should be locked in the trunk of the vehicle until needed. The trunk key should be carefully hidden so as to make it difficult to search the trunk in case law enforcement agents should stop the car on some pretext with the intention of searching it illegally.

## WEAPONS AND EQUIPMENT

Selection of weapons and supplies should give the Combat Team maximum flexibility to meet any condition that may be encountered in either rural or urban warfare. Consideration should be given to all possible situations that may develop relating to both traditional guerrilla warfare and modern underground warfare techniques. It should be kept in mind that the Combat Team is a functional part of a resistance network. Its activities should be coordinated with other teams to take maximum advantage of its striking powers.

Disregarding the inclusion of weapons peculiar to a given mission, the standard distribution of men and weapons could be as follows:

- #1 (Team Lieutenant) AR-180 Assault Rifle, automatic pistol, sheath knife, flare gun, and binoculars. 300 rounds of ammunition loaded in clips should be carried for the rifle, plus 50 extra rounds of ammunition for the pistol.
- #2 (Team Member) Riot Shotgun, automatic pistol, sheath knife, and wire cutters (with insulated handles). 100 rounds of No. 4 Buckshot in pouches for the shotgun, and 50 rounds of pistol ammunition.
- #3 (Team Member) AR-180 Assault Rifle, automatic pistol, sheath knife, and smoke grenades or flares. 300 rounds of ammunition in clips for the rifle, and 50 rounds of pistol ammunition.
- #4 (Team Sergeant) AR-180 Assault Rifle, automatic pistol, sheath knife, flare gun, and binoculars. Ammunition requirement is the same as #1 man.
- #5 (Team Member) M1903 Springfield Rifle with sniper scope, automatic pistol, sheath knife, and entrenching shovel. 100 rounds of AP ammunition in bandoleers for the rifle, and 50 rounds of pistol ammunition.
- #6 (Team Member) AR-180 Assault Rifle, automatic pistol, sheath knife, and 30 feet of climbing rope with grappling hook. Ammunition requirement is the same as #1 man.

### ADDITIONAL MATERIAL

In addition to the weapons and supplies already listed each team member should have the following basic equipment:

- a. Sleeping bag and waterproof ground cloth
- b. Canteen ( 1 quart army type)
- c. Survival rations for three days
- d. First aid kit
- e. Gas mask with extra filter
- f. Flashlight with extra batteries
- g. Fatigue or camouflage clothing
- h. Combat or paratrooper boots

SECRET ARMY ORGANIZATION

30

## PRACTICAL SECURITY MEASURES

1. Use deceptive measures. Subscribe to one or more left-wing periodicals or get on the mailing list of some "peace movement". This will keep the postal inspectors guessing as to which side you are really on. While doing this our members can be of great assistance in searching this left-wing literature for names and addresses of fellow travelers and forwarding this information for our Central Intelligence files. We desperately need people to assist in this work. Please inquire as to detailed instructions for such activity.

2. Always use two envelopes in sending mail to any patriotic organizations or to any other member of our own organization. Do not put a return address on the outer envelope. Put your return address on the inside envelope with the words, "return postage guaranteed".

3. Place some opaque material such as tin foil, carbon paper, etc. between the inner and outer envelopes to prevent your mail from being read by infra-red cameras.

4. Send all letters from corner mail boxes or from post offices where you are not known.

5. Be careful in the use of the telephone. Avoid telephone calls to known members of the organization as much as possible.

6. Prepare telephone codes ahead of time for future protection.

7. In recruiting new members always learn as much as you can about the prospective recruit and make sure he is not an infiltrator before you identify yourself as a member of the organization.

8. Members of the organization in each area should be divided into four groups:

- A. Those who have been identified publicly or by law enforcement agencies as members of the Secret Army Organization.
- B. Those persons not known as members of this organization but who are generally known as being patriots.
- C. Those persons who have kept their political beliefs hidden.
- D. Members who profess to be liberal for the purpose of infiltrating enemy organizations.

All members should be very careful in making contact with persons in a different category than themselves. For example, people in Class D should be very secret in their contacts and communications with persons of Class A or Class

B. Each member must respect the security of every other member. Do not, under any circumstances, identify one member of the organization even to other members without his expressed permission on each and every occasion.

9. Avoid loose talk. Do not discuss organizational plans in public places where you could be overheard. Do not even hint at such a discussion in the presence of non-members.

10. Do not write patriotic letters to newspapers or magazines under your own name. To do so achieves very little except to identify you to the enemy.

11. If you are already known as a patriot, or as a member of this organization you may find it advisable to spread the rumor that you have become disillusioned with the right-wing or for you to pretend a gradual loss of interest.

12. Classify your various members addresses, your communications and your other activities as "top secret", "secret" or "restricted". Use your most secret lines of communication only for the most important messages rather than flooding them with unimportant material.

13. Demand obedience to all security measures from all members. Persistent disregard for security measures should be cause for disciplinary action.

14. Check your lines of communication from time to time by sending phoney messages to make certain they are not intercepted.

15. Change mail drops, meeting places, etc. frequently.

16. Prepare secret rendezvous points, mail drops, etc. now that may be used in time of some future emergency.

17. Each unit should assign some member the rank of Security Officer and should set up a system of fines or other penalties for failure to comply with security precautions.

18. Observe the "need to know" rule. Each member should be given only that information which is needed by him in the performance of his duty or which he will need in cooperating with other members of the unit. No member should feel "left out" because he is denied such information. Instead every member should willingly avoid information which he does not need.

19. Be careful that you are not followed in going to and from meeting places or in making contact with other members of the organization.

20. Keep all records and correspondence carefully hidden and in a manner that they can be easily destroyed. Records should be kept in code whenever possible.

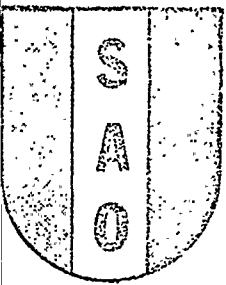

**SECRET ARMY ORGANIZATION**  
GENERAL HEADQUARTERS

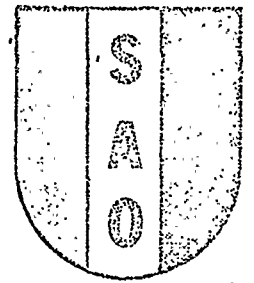

Dear Fellow American,

Enclosed with this letter is your Preliminary Training Program. This first program is only a brief outline of some of the material that will be covered in later programs. There are four basic programs used by the Secret Army Organization: Intelligence, Security, Propaganda, and Recruiting, in that order. Each program will cost the new member \$3.00 and will take between one to three weeks to complete.

The correspondence training program serves a number of purposes, but the two major purposes are:

1. It lets us know which members of the organization have the patience and determination to finish assignments given them.
2. It lets us be certain that the members have the necessary basic training in intelligence, security, etc., which is essential to almost any important task which we could assign a member in underground warfare.

Proper training in these four basic skills is absolutely essential for every member of an underground army. A member may be an expert in survival techniques, use of weapons, urban warfare tactics and all the rest but experience has shown that without these other basic skills they seldom do much fighting - they just commit suicide.

For those of you who wish to become active and trusted members of the Secret Army Organization, let us emphasize again that the quickest way of doing so is to begin and diligently complete the basic training programs.

After you have completed the five work projects listed in the Preliminary Training Program send \$3.00 in to your regular mail drop and we will send you the first training program on Intelligence. In view of the urgent situation we now face some of our new members may receive special assignments after having completed the first two training programs. If this happens please try to redouble your efforts so that your special assignments can be taken care of while continuing to complete your regular training program.

SECRET ARMY ORGANIZATION

33

# Secret Army Organization

## PRELIMINARY TRAINING PROGRAM

It would be a mistake to think that our enemies have one set plan for the conquest of the United States. They are maintaining many continuous attacks on many fronts at the same time - political, education, business, labor, and even religion. They are continuously probing for weak spots in the defenses of our nation. During the past forty years so many openings have been left to them by the stupidity and collusion of our national leaders that they have been able to advance almost at will.

There is little we can do to change this situation at this time. Rather than deplete our limited resources on futile attempts to do so, we must concentrate on building a workable anti-communist underground army based on realities rather than wishful thinking and organized on the tried and proven principles of underground warfare.

The communists have fifty years experience in suppressing anti-communist underground activity. If we are to fight them successfully - if we are to hold out until the final victory of freedom over tyranny - then our underground army is going to have to be the most skillful and dedicated that the world has ever known. There is only one kind of member that can qualify for such an army - the very best!

This will require intensive training and practice. There is no short cut to perfection. By drawing on the talents of several of our more experienced members we think we now have a training program that can develop that kind of underground army.

In this program four different types of training will be involved:

1. Correspondence and printed material.
2. Tape recordings, picture slides, charts, etc., sold or loaned to S. A. O. units or members.
3. Actual experience - "On the job" training by carrying out assignments under supervision of more experienced members.
4. Training maneuvers - Due to the difficulty of keeping large training sessions secret the General Staff has decided that such training sessions will be held only for small select groups that have already completed sufficient preliminary training at the local level.

### INTELLIGENCE - SECURITY - PROPAGANDA

This preliminary training lesson is designed to give our members basic knowledge and practice in intelligence, security and propaganda. This first lesson is basic

preparation for advanced training in these three important activities which will be dealt with in greater detail further on in the training program.

## INTELLIGENCE

Underground warfare, as we customarily think of it, cannot succeed unless it is supported by a well developed organization comprising all the essential functions of intelligence, security, propaganda, communications, supply, medical services, etc.

Of all these, intelligence is most important. Let's consider one example: Suppose you picked up a telephone book, opened it up to any page at random, closed your eyes and put your finger on one name. Now suppose you read that name for the first time and said to yourself, "Sometime in the next 30 days I'm going to kill this man."

Consider the situation - one man, picked at random is marked for death. He might be the most powerful, the wealthiest, the most influential man in that city but none of these things would help him in the least. He would be defenseless. Why? Because you would have one thing that he did not have - intelligence. You would know his identity and he would not know yours. So long as that condition continued, there would be no possible way in which he could arrange an adequate defense against you.

Exactly the same situation exists between ourselves and our communist and socialist enemies. Our success will be directly proportionate to our knowledge of them and inversely proportionate to their knowledge of us.

Whatever a member's principal job may be in the Secret Army Organization, he must have a basic knowledge of intelligence techniques. This subject is therefore the first to be considered in our training program.

The word "intelligence", when used in a military sense refers to those methods that can be used to gain useful information. We usually think of this as knowledge of the enemy but it also includes information about the terrain, general population, available supplies and all other facts that will help in planning future activities.

Intelligence is roughly divided into three parts:

1. Observation. During a hot war this includes scouting and patrolling, observation of enemy troop movements, etc. On the cold war front this includes shadowing of enemy personnel, surveillance of enemy officers, tapping of telephones, interception of messages, etc.

2. Research and Analysis. Collecting and cataloging all possible useful information from general sources, newspapers, radio, trade magazines, etc., then-matching up isolated scraps of information until an accurate picture is obtained of some situation that would not otherwise be known.



3. Espionage. This involves the placing or recruiting of agents within the enemy personnel where they can learn the enemy's plans first hand, steal the enemy's documents or materials, influence or misdirect the enemy's plans or policies.

Suppose you had a chance to see some important document for just a few minutes. How quickly could you scan it for its essential content? How well could you separate the important from the unimportant? Could you record this information in a written message that can be easily read and will not be misinterpreted?

Imagine that you are the leader of a patrol sent forward to observe and track an enemy column prior to a possible ambush. From time to time you will need to send back your observations in written form. Each S. A. O. member must develop the ability to put his thoughts on paper in such a way that they will be easily read and unmistakable.

The first two projects are designed to give the new member an opportunity to test these skills while learning ( or reviewing) basic elements of espionage activity. When these have been completed more advanced material will be furnished to the member directly. Useful intelligence projects of increasing complexity and importance will be assigned to those wishing to specialize in this work.

### SECURITY

It is obvious what a great advantage we can gain over our enemies by proper information about their plans and activities. It is equally true that much of this advantage will be lost unless we can keep our plans and activities secret from them. This is the basic purpose of all security activities. Overall security operations of an underground movement can be divided into five basic parts:

1. Protecting the identity of underground personnel and their families.
2. Keeping secret the location, movements and plans of underground units.
3. Keeping secret the location of underground headquarters, alternate hideouts and supply depots.
4. Protecting the identity of civilians, or individual members of the population that are friendly to underground forces.
5. Maintaining secrecy of communications.

As we have already said it is difficult to even guess what forms the coming conflict will take. Nevertheless, the strategy of all successful underground movements must satisfy these three basic principles:

First, is the "Principle of Deliberate Delay". During this state, the underground gathers its forces, checks its security, prepares its intelligence, establishes its lines of communications and waits for the enemy to become complacent and overconfident.

Second is the "Principle of Provocation". At the beginning of this stage only a few real patriots are willing to take part in underground activity. The vast majority of the population is still wishfully thinking that they can "get along" with the oppressive forces. They want only to be left alone and will not take action until they are personally threatened. During this stage the underground conducts a series of actions which provoke the enemy forces into making harsh repressive measures on the general population. This turns the general population against the oppressive forces and convinces them that the underground is really their only hope.

Stage Three may be called "Principle of Natural Allies". When the government's action against the general population becomes sufficiently brutal then large numbers of people will be willing to help or join the underground. Their reasons for doing so may be numerous and their ideology may not always be the same as the basic underground movement. During this stage minor differences between different underground groups must be minimized and all of our natural allies must be rallied to the cause of freedom.

The intelligence branch of our organization is well aware of the communist infiltration and control of the present United States government. It can rightly be said that we are now partially controlled by a foreign ideology. Thus, we are already engaged in Phase I of this conflict. How long this will continue until open warfare breaks out is anyone's guess. Once again, the best prediction of our intelligence department is that Stage II will last for several months, perhaps even years. This will be a time of assassination and counter assassination, terror and counter terror. During this phase the "average citizen" may avoid direct conflict at the price of his dignity and individual freedom. Known patriots will be in extreme danger.

- For most people membership in the Secret Army Organization will not materially increase their danger during this time. For many years our enemies have carefully catalogued the name and address of every person who has ever written a patriotic letter to a newspaper. The membership lists of the more prominent "conservative" organizations have long been available to communist infiltrators in these organizations.

Continued activity and membership in other conservative organizations by members of the S. A. O. is desirable in many cases but those individuals should not identify themselves as members of the Secret Army Organization. For most of our own members it will be best if you do not take part in the activities of these other organizations. Although many of you are already "marked" men a certain degree of security can still be achieved by quietly dropping out of other right-wing activities and keeping your membership in the S. A. O. secret from all except your most trusted fellow members.

There may come a time when the average American is still able to go about his business with little regimentation but during which you as a known or suspected patriot, may be sought out for arrest or assassination.

Project III listed at the end of this chapter may make it possible for the organization to contact you and render assistance should you ever find it necessary to go into hiding with little advance notice.

Project IV is a first step toward learning more about your enemies and at the same time, confusing them as to which side you are really on.

### PROPAGANDA

Another essential function of the underground is to convincingly inform the general public of what they stand for and thus gain the support of the general population. This must be done through propaganda, both written and spoken. Under conditions of enemy occupation the spreading of anti-communist propaganda would obviously be very dangerous. Even now there are certain phases of our propaganda effort that is best done by surreptitious means. Thus, observation, communication and propaganda are three elementary duties of every underground member.

Never before has propaganda been so important to the ultimate outcome of a major conflict. The ultimate object of any war is to force your desires on the minds of your enemies. Our enemies are attempting to do this by the non-violent means of psychological warfare.

# Secret Army Organization

## PRELIMINARY TRAINING LESSON

### Project No. 1

Look over the various books in your local public library that have been written on intelligence and espionage. Select two that seem best and read them carefully.

### Project No. 2

Write a brief outline of these two books and send it to your regular assigned mail drop or to General Headquarters.

### Project No. 3

Get in touch with one trusted friend that you do not ordinarily see too often. Preferably one that does not live in your present neighborhood. Inform him that he may, in the future, receive letters with an inner envelope with your name on it. Make sure he will keep these envelopes confidential and will secretly pass them on to you or hold them until you can pick them up. Let us know this alternate address in case we need to contact you in extreme circumstances.

### Project No. 4

Make necessary preparations to use a fictitious name for receipt of left-wing literature and correspondence. An important part of each members duties is to keep yourself and our organization informed on left-wing and communist activity in your area.

A phoney organization that includes the word "Peace" as part of its name is always a suitable cover. The address can be a P. O. Box, that of a friend, or even your own address. Mail several letters to the name and address you decide on to get the postal employees accustomed to it now. Then you will be ready to use it for the real thing.

### Project No. 5

While working in the library, place the enclosed Secret Army Organization leaflets in between the pages of various books where they will be found and read by others.

# Secret Army Organization

## TRAINING PROGRAM

### INTELLIGENCE

We are faced with a dangerous enemy who has repeatedly boasted of his plans to destroy our Constitutional Republic and to enslave our people.

For more than forty years they have been infiltrating their agents into the most sensitive areas of labor, press, entertainment, education, law, communications, religion, industry and government. The degree of their success is made obvious by our government's failure to oppose communism internationally and by our fellow citizens' lack of interest in their own preservation.

We already know a considerable amount about this enemy; their origin, objectives, approximate strength, organizational structure and general methods of operation.

There are four areas where we especially need additional information:

1. Details of the techniques used in espionage, infiltration and subversion by individual agents, including the methods by which they control their fellow travelers.
2. The equipment used for surveillance, communication, assassination, sabotage, etc., by individual enemy agents.
3. Working details of their short range programs either in operation or planned for the near future.
4. The actual identity of enemy agents, fellow travelers and sympathizers along with details regarding their work, place of residence, cover operation, means of transportation, travel pattern, personal appearance, mental characteristics, personal lives, business and organizational activities.

Our ultimate victory or defeat may depend on our ability to obtain enough of this vitally important information.

There are literally thousands of sources from which bits of valuable information can be obtained. These range from such extremes as the local newspapers to documents stolen from the enemy's guarded vaults.

The methods of gathering intelligence are roughly divided into two groups: 1) Research and Analysis, and 2) Espionage.

Espionage includes all the "illegal" means of obtaining information, such as wire-tapping, interception of mail, stealing of documents, secretly photographing records, infiltrating spies into enemy organizations, bribing or blackmailing individuals of the enemy apparatus.

Research and Analysis includes the careful systematic search of all newspapers, magazines, trade journals, house organs, political pamphlets, books, public records, etc., to sift a few "needles" of valuable intelligence from several "haystacks" of general information.

Professional intelligence organizations obtain about 95% of their information from Research and Analysis and only about 5% from Espionage. When espionage techniques are used, they prove most effective when a specific mission is carefully planned out in advance which takes advantage of all possible background information that may be obtained by research methods.

Let's examine how these various techniques might be used to obtain additional information of the four basic types we need most.

1. Details of the techniques used in espionage, infiltration and subversion by individual agents including methods by which they control their fellow travelers.

An agent trainee may learn something of the general espionage methods used by communist agents who have defected from the party and have then written about their experiences. Beyond this they are of very little value. The actual details of such techniques are uniformly neglected.

More useful information can be obtained from the study of past court records in which evidence has been presented in espionage cases. Hints and clues may occasionally be picked up from continuous and careful study of the regular news media. Really basic information of this type, however, must be obtained by infiltration and espionage techniques.

2. The equipment used for surveillance, communications, assassination, sabotage, etc., by individual agents.

Hints about the type of hidden microphones, short wave transmitters, miniature tape recorders, etc. used in surveillance and communication by espionage agents sometimes are mentioned by chance in the regular press or news magazines, in connection with reported spy cases. Technical details and construction plans occasionally are given in the electronics or "Popular Science" type magazines. Other information may be requested directly from the manufacturers of such equipment.

The type of short acting or long acting poisons best suited for assassination under various conditions might be anticipated by a careful study of toxicology; from "Chemical Abstracts" and Biological Abstracts"; from current magazines on pharmacology, as well as from such magazines as "Scientific Monthly" and "Science Newsletter", all available from larger city libraries.

Information on explosives is available from ordinance journals, literature from manufacturers, technical books, mining and drilling magazines, etc.

Naturally, such special fields of interest are best pursued by some person who already has an aptitude in each particular line.

This is one of the things that makes us feel that the American people are uniquely equipped to form a deadly effective underground. Nowhere else in the world does any population have as many useful hobbies and avocations that could be adapted to underground warfare. Many by products of these hobbies can be used as sabotage instruments. Just one typical example - the dust from grinding wheels in metal shops should be saved to mix with grease for the bearings of enemy machinery.

### 3. Working details of their immediate and future plans and activities.

Advance information about "peace marches" and racial demonstrations can be had by subscribing to appropriate communist front publications. Details as to the size of the demonstration and degree of violence anticipated must be obtained by infiltrating such organizations. Communist plans for future propaganda campaigns, subversion, espionage, blackmail of government officials, etc., may be learned directly by infiltration or may be deduced from a close study of their past activities.

### 4. Identity and personal information about enemy agents.

This requires the full scope of counter espionage activity; research and analysis of enemy publications, monitoring of communist sponsored meetings, surveillance of party offices, infiltration of enemy apparatus, recruitment of double agents, interception of enemy communications, etc., etc.

## TECHNIQUES OF EFFECTIVE RESEARCH

1. Every researcher should be constantly on the alert for useful information in the general news media - radio, TV, magazines, etc.

2. Each researcher should have one field of interest to which he gives special attention.

For example:

One researcher might read every book available on "escape and evasion" and all the stories or articles written on prison escapes, looking for ideas that might someday help our members escape from a concentration camp.

Another researcher might continuously search the communist front publications for names of fellow travelers; for announcements of future meetings, rallies or similar activities; for additional information that would tie suspected communists to known communist organization; for friendships, business connections and family relationships between known communists and unknown communists.

Each city should have one researcher that carefully reads the daily papers to extract such information as: names of speakers at left wing meetings, names and addresses of both left and right wing letters to the editor, social functions attended by known communists, names of persons who might be potential recruits, news of coming "peace marches" and similar demonstrations, expressions of either pro or anti communist sentiments by local public officials, educators, businessmen, ministers, etc., evidence of communist inspired violence, sabotage or blackmail.

There is an almost endless variety of areas that need to be covered. Based on his or her own interests and abilities each researcher should choose the specialty for which they are best qualified.

3. Be as specific as possible. Look for details. Include blue-prints, drawings or photographs of all technical equipment when possible. Don't expect your analyst to be a "mind reader". Include all the facts. Continuously ask yourself the questions: Would this information be of value to the Secret Army Organization? To individual espionage agents? To other members? To our technical specialists?

4. Avoid editorial opinions and general news items as these are of little value and needlessly swamp our limited staff of analysts.

5. Do all the work locally that you possibly can. If the person is local, look them up in the telephone book or cross index. Double check to make sure the address is correct and that they still live there. Type cards if possible, otherwise, print plainly. Include phone numbers and licence numbers of cars whenever possible.

6. Use standard 3 x 5 inch index cards for sending in information on individuals. Clip pages of magazines or photostat important articles. In outlining books, be sure important facts are fully covered.

7. Always state the source of all information reported to the organization.



Printed below is a sample index card showing the proper placement of information. Use it as a guide when making out your cards.

Smith, John D.

December 1, 1970

Home Address: 657 Riverside Drive  
Los Angeles, California 90000  
Telephone: 222-3333

Automobile: 1968 Ford, Green 4-Door, Lic. No. CAL 555

Activities: Gave a talk against war to the Santa Ana Chapter of the Peace and Freedom Party. Smith is a full Professor of Political Science at UCLA. (source: Los Angeles Times, page A-4, November 28, 1970)

XXXX

(member's ID number)

## WORK PROJECTS

1. Write to the following "peace publication" (most of them are actually communist fronts) and ask for subscription price and a sample copy.
- 
- 
- 

(A) When these sample copies are received by you, proceed to make out an index card on each person mentioned as supporting or taking part in any peace organization. Do not forget to include the magazine staff (editor, circulation manager, authors, etc.) Include a description of the position held or activity referred to for each.

(B) Analyze the propaganda content of each magazine - in what way does it serve the communist cause? When completed, send these magazines in to your regular assigned mail drop along with your index cards, comments and analysis.

2. Using your fictitious name, write to the following "peace organization". Tell them you are concerned about the world situation and would like to help in the peace movement. Ask for the location of their nearest headquarters or a local member you could contact, as well as further information about their organizational plans and objectives.
- 
- 
- 

(A) Make out index cards on all persons listed on their letterhead and in their literature.

(B) Analyze their propaganda literature and forward it to your regular mail drop along with your comments on how this particular organization promotes communist objectives.

(C) Send a note to let us know what research specialty you feel best qualified for and what plans you are making to gain useful information in this field.

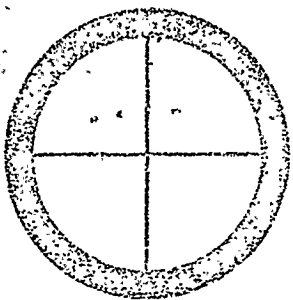

# SECRET ARMY ORGANIZATION

## SPECIAL BULLETIN

No doubt most citizens of San Diego are aware of the controversy surrounding the activities of San Diego State Economics Professor PETER G. BOHMER. For any of you who are not, here is a brief run down:

Bohmer, age 27, is a self-proclaimed left wing radical professor out at San Diego State who among other things has been teaching that the communist economic system is superior to our own free enterprize system. That the tax payers have to put with this kind of reason is bad enough, but it does not end there. Bohmer, who has a long record of communist activities behind him, has made it his policy to give lower grades to students in his classroom who do not share his left wing views. One of his students was a veteran of the Vietnam War, with a fine combat record. This student was a special target of Bohmer, who never missed an opportunity to ridicule and insult this students beliefs.

A quick look at Bohmer's record will show why he hated this student. In 1970 Bohmer's record will show 45 days in the pokey for anti-war protesting. This was when he was a graduate student at MIT in Massachusetts. The demonstration that earned him his jail was against defense research conducted on the MIT campus. He was also a member of SDS and a supporter of the Black Panther Party while at Harvard and MIT. It does seem strange that San Diego State was not able to find another professor somewhere who was not a communist jail bird.

For any of our readers who may care to look up this Red Scum, and say hello, here is some information that may help. His address is 5155 Muir, Ocean Beach, telephone number is 222-7243, he drives a dark blue 1968 VW Sedan, California license DK1 147. Just to make sure you talk to the right guy here is his description: he has dark brown shoulder length hair, green eyes, weight is about 160 lbs. and he is 5'10" tall. Now in case any of you don't believe in hitting people who wear glasses, to be fair I guess we will have to tell you he wears contact lences.

If you do run out to see Bohmer one night here are a few other people you may run into: Michele Kinsky, she is Bohmer's girl friend and lives at the same address as he. She is a student at San Diego State. She is no doubt the "Teacher's Pet". One can bet she gets good grades. She drives a bronze two door Corvair with the front smashed in, California license KUZ 777. Next comes George Katsiaticas, a good friend of Bohmer's. George came from Boston a short time after Bohmer, and lives at the Muir address too. Next in line comes Sharl Ann Whitehead, she is George's girl friend and lives at the Muir address part of the time. The rest of the time you can find her at 302 Whaley, Oceanside. She drives a 1965 two door Dodge Dart, number RGH 420. And lastly we come to Elizabeth Jane Guard of 3544 Indiana St., San Diego. Her car is a Plymouth Valiant 1964 light blue, license number HJ 385. Who's girl friend she is, is your guess.

46



UNITED STATES DEPARTMENT OF JUSTICE  
FEDERAL BUREAU OF INVESTIGATION

San Diego, California  
January 21, 1972

In Reply, Please Refer to  
File No.

Title	SECRET ARMY ORGANIZATION (SAO)
Character	EXTREMIST MATTERS -SECRET ARMY ORGANIZATION
Reference	Report of SA STEVEN L. CHRISTENSEN dated and captioned as above at San Diego, California.

All sources (except any listed below) used in referenced communication have furnished reliable information in the past.

UNITED STATES GOVERNMENT

# Memorandum

TO : Mr. E. S. Miller *esm*

FROM : G. C. Moore *GCM*

SUBJECT: *SECRET* ARMY ORGANIZATION  
EXTREMIST MATTERS

- 1 - Mr. W. M. Felt
  - 1 - Mr. A. Rosen
  - 1 - Mr. T. E. Bishop
- DATE: 1/11/72

- 1 - Mr. E. S. Miller
- 1 - Mr. G. C. Moore
- 1 - Mr. R. L. Shackelford
- 1 - Mr. T. J. Smith
- 1 - Mr. L. G. Brockman

Tolson \_\_\_\_\_  
 Felt \_\_\_\_\_  
 Rosen \_\_\_\_\_  
 Mohr \_\_\_\_\_  
 Bishop \_\_\_\_\_  
 Callahan \_\_\_\_\_  
 Casper \_\_\_\_\_  
 Conrad \_\_\_\_\_  
 Dalbey \_\_\_\_\_  
 Cleveland \_\_\_\_\_  
 Ponder \_\_\_\_\_  
 Bates \_\_\_\_\_  
 Walkart \_\_\_\_\_  
 Walters \_\_\_\_\_  
 Evans \_\_\_\_\_  
 Tele. Room \_\_\_\_\_  
 Holmes \_\_\_\_\_  
 Gandy \_\_\_\_\_

*B. J. Moore*

The purpose of this memorandum is to advise that a new group known as "Secret Army Organization" (SAO), a small ultra-conservative paramilitary organization recently formed in the San Diego, California, area, reportedly has been involved in extremist acts.

A confidential source recently furnished information regarding a clandestine meeting and plans to form a new white-hate organization called SAO which reportedly would take the place of the Minutemen group in San Diego. The Minutemen, also a paramilitary group, was organized in Missouri during 1960 to act as a resistance to the spread of communism by use of guerrilla tactics.

During the evening of 1/6/72, two shots were fired, injuring one person, at the residence of Peter Bohmer, a San Diego State College professor. Shots reportedly came from the direction of a passing automobile and were fired by a white male described as being in his mid twenties. Bohmer and others at his residence at the time of the shooting reportedly are active in the San Diego Convention Coalition which is a New Left group formed during the Fall of 1971 to organize demonstrations at the Republican National Convention scheduled to be held in San Diego during August, 1972. Bohmer reportedly has indicated that on 1/6/72 prior to the shooting he received two threatening telephone calls from persons stating they were members of SAO. A sticker of SAO was also pasted to the door of Bohmer's office.

Some SAO organizers appear to be identical with individuals who were formerly involved in Minutemen activities. Our San Diego Office has been instructed to vigorously pursue all aspects in the investigation of this new group.

157-23577

EX-104 *15*

REC-48

*157-23577-6*

LGB:cal  
(9)

*Full*

5 JAN 20 1972  
CONTINUED OVER

57 JAN 27 1972

Memorandum to Mr. E. S. Miller  
Re: Secret Army Organization  
157-23577

Pertinent information concerning this shooting attack and threatening calls has been included in the daily teletype summary regarding Protest Activity and Civil Disturbances which is furnished The White House and other interested Government agencies. You will be advised of any further pertinent developments.

ACTION:

For information.

GB  
HEH  
DEM

~~PLP~~

EM  
AS  
WAS

CODE

TELETYPE

NITEL

TO SAN DIEGO

1/10/72

FROM DIRECTOR, FBI

1 - Mr. R.L. Shackelford  
1 - Mr. T.J. Smith  
(Mr. R. Horner)

SECRET ARMY ORGANIZATION (SAO), EXTREMIST MATTERS. 1 - Mr. Brockman

REBULET TO PHOENIX NOVEMBER NINE LAST AND YOUR TELETYPE

JANUARY SEVEN LAST ENTITLED "CALREP, NEW LEFT MOVEMENT - VIOLENCE, IS - NEW LEFT."

IN VIEW OF INFORMATION CONTAINED IN REFERENCED TELETYPE YOU SHOULD VIGOROUSLY INTENSIFY YOUR INVESTIGATION OF SAO TO ASCERTAIN ITS AIMS AND OBJECTIVES, DISCREETLY IDENTIFY ITS LEADERS AND MEMBERS AND DETERMINE IF ANY ACTS OF VIOLENCE ARE BEING PLANNED. LOGICAL SOURCES SHOULD BE TARGETED TO DETERMINE LOCATION OF ANY MEETINGS BY MEMBERS OF THIS GROUP AND DATA REGARDING ANY WEAPONS MEMBERS MAY POSSESS.

LOGICAL SOURCES SHOULD BE TARGETED TO DISCREETLY DEVELOP ANY INTELLIGENCE DATA REGARDING THREATENING TELEPHONE CALLS BY MEMBERS OF SAO, AS MENTIONED IN REFERENCED TELETYPE. YOUR SOURCES SHOULD BE TARGETED TO OBTAIN ADVANCE INTELLIGENCE DATA REGARDING ANY POSSIBLE VIOLENCE BY MEMBERS OF THIS GROUP.

LGB:amk/ege  
(5)

EX-117

REG-41

157-23577-5

SEE NOTE PAGE TWO

FEDERAL BUREAU OF INVESTIGATION  
COMMUNICATIONS SECTION

JAN 10 1972

JAN 17 1972

TELETYPE

JAN 24 1972

157-23577

MAIL ROOM

TELETYPE UNIT

- Mr. Tolson
- Mr. Felt
- Mr. Rosen
- Mr. Mohr
- Mr. Bishop
- Mr. Miller
- Mr. Callahan
- Mr. Casper
- Mr. Conrad
- Mr. Dalbey
- Mr. Cleveland
- Mr. Ponder
- Mr. Bates
- Mr. Waikart
- Mr. Walters
- Mr. Sears
- Tele. Room
- Miss Holmes
- Miss Gandy

TELETYPE TO SAN DIEGO  
RE: SECRET ARMY ORGANIZATION

ALL PERTINENT INFORMATION DEVELOPED SHOULD BE PROMPTLY  
SUBMITTED IN FORM SUITABLE FOR DISSEMINATION.

NOTE:

Referenced teletype indicated two shots were fired during the evening of 1/6/72 at the residence of Peter Bohmer, a San Diego State College Professor. One individual at the residence was wounded by gunfire. Referenced teletype indicated Bohmer and others at his residence at the time of shooting are active in the San Diego Convention Coalition, described as a group formed during the Fall of 1971 to organize disruption at Republic National Convention to be held in San Diego, August, 1972. Referenced teletype further indicated Bohmer mentioned he had early on 1/6/72 received two threatening telephone calls from persons stating they were members of the Secret Army Organization. It was also indicated that sticker of SAO was placed on the door of Bohmer's office.

SAO has been described as an ultra-conservative/<sup>para</sup>military organization recently formed in the San Diego area to replace the Minutemen organization. Minutemen is a paramilitary group organized in June, 1960, as a resistance to the spread of communism in the United States by use of guerrilla tactics.

San Diego has previously been instructed to determine aims and objectives and identities of officers of captioned organization. In view of data contained in referenced teletype, San Diego being instructed to attempt to intensify its investigation of this organization.



UNITED STATES GOVERNMENT

# Memorandum

TO : DIRECTOR, FBI (157-23577)

DATE: 12/22/71

FROM : SAC, PHOENIX (157-1173) (P)

SUBJECT: SECRET ARMY ORGANIZATION (SAO)  
EXTREMIST MATTERS  
OO: SD

*PMB/umz*

Re PX letter to Bureau, 10/22/71 and Bureau letter to PX, 11/9/71.

On 12/13/71, [redacted] furnished additional printed material concerning the Secret Army Organization which he received through the mails from "SAM", in an envelope postmarked at Lemon Grove, California on December 8, 1971. The envelope bore the return address, "Artist Supply, P.O. Box 593, Lemon Grove 92045." This material is the subject matter of a letterhead memorandum, six copies of which are enclosed for the Bureau. *W*

For the information of the Seattle Office, the letter which accompanied the referenced material made reference to "our friend up in Washington who was tied up in court on December 3 as a witness for a friend who was busted by the Eye." "SAM" indicated that "our friend up North" would be traveling with him in January, and that the "friend in Northland said that his people are real hot for the idea of starting a branch." "SAM" also wrote, "We are looking for a buy on some tear gas grenades and cartridges."

*806*  
*D*

EX-101

REC-62

157-23577-4

- 2 - Bureau (enc. 6) (RM)
- 2 - San Diego (enc. 5) (RM)
- 2 - Sacramento (enc. 2) (RM) (info.)
- 2 - San Francisco (enc. 2) (RM) (info.)
- 2 - Seattle (enc. 3) (RM) (info.)
- 2 - Los Angeles (enc. 2) (info.) (RM)
- 2 - Kansas City (enc. 2) (RM) (info.)
- 2 - Oklahoma City (enc. 2) (RM) (info.)
- 2 - Las Vegas (enc. 3) (RM) (info.)
- 2 - Phoenix

16 DEC 27 1971

CLC/pas

(20) *ISD, EDZU, SS*

*R/S 1/1/72*  
*hek/uv*

EXT. INT. [initials]

PX-157-1173  
CLC/pas

Copies of this LHM are being sent to offices having direct and potential interest in this matter:

This LHM is being classified confidential to protect the confidential informant, who, at the juncture of the investigation, appears to be the only source of information in the Phoenix Division.



UNITED STATES DEPARTMENT OF JUSTICE

FEDERAL BUREAU OF INVESTIGATION

In Reply, Please Refer to  
File No.

Phoenix, Arizona  
December 21, 1971

SECRET ARMY ORGANIZATION

A confidential informant has made background information available concerning the emergence of a new "patriotic" group under the name "Secret Army Organization".

Five former members of the Minutemen organization met in secret in October, 1971, for the purpose, in their words, of effecting "an organization of loyal Americans dedicated to the preservation of both national and individual freedom."

According to source, this is predominantly a Minutemen oriented movement which couches its statement of principles as follows in a piece of its literature captioned "Join the Secret Army Organization":

- 1) To prepare the means of personal defense and survival in case of enemy attack.
- 2) To resist and expose the spread of communist influence and propaganda within our own national boundaries.
- 3) To investigate by means of our own secret memberships the infiltration of communist sympathizers into American organizations of government, business, labor, religion and education.

CONFIDENTIAL

Group I

Excluded from Automatic  
Downgrading and Declassification

This document contains neither recommendations nor conclusions of the FBI. It is the property of the FBI and is loaned to your agency; it and its contents are not to be distributed outside your agency.

ENCLOSURE

## SECRET ARMY ORGANIZATION

- 4) To resist by any and all means the passage of laws which regulate the private ownership of firearms or which detract from the individual's ability to defend his own family and personal property.
- 5) To promote knowledge and skill in the use of arms by our own members and by the general public.
- 6) To form in advance of actual need a secret underground organization equipped to spy upon, harrass and destroy troops of any foreign power that might occupy United States territory.
- 7) To lend assistance and support wherever possible to other resistance organizations, domestic or foreign, opposing communist expansion or subversion.

MEMBER OF SUBJECT ORGANIZATION

- 8) To pursue these programs as private citizens motivated only by patriotism and to remain entirely free of government subsidies or control.

*B. APPROX 1938*

The organizing members of the Secret Army Organization have not been completely identified, but organization of the group is being spearheaded by Jerry Davis, also known as "Sam" Davis, of San Diego, California, utilizing the mail drop address "Artist Supply, P.O. Box 503, Lemon Grove, California, 92045." A second general mail drop for the organization is "S.A.O., P.O. Box 5791, San Diego, California, 92105." A third mail drop is "Howard Clark, 1080 6th Street, Ramona, California, 92065."

Jerry Davis is described as a white male, American, age 33, height 5'8", weight 150 pounds.

There is attached to and made a part of this memorandum printed material (photocopied) from Secret Army Organization headquarters which characterizes further the captioned organization.

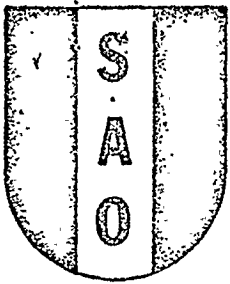

# SECRET ARMY ORGANIZATION

## GENERAL HEADQUARTERS

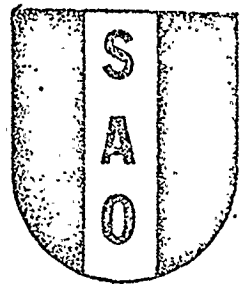

CONFIDENTIAL

Dear Fellow American,

Your application for membership in the Secret Army Organization has been processed and approved. It is our profound hope that your membership in the S. A. O. will prove to be a benefit to the organization and yourself as well. A dedicated member will find that his association with our organization is a way of life that is far more rewarding than the ordinary mediocre existence of his fellow enlightened citizens.

For security purposes all records regarding individual members are listed by numbers only. Your number will be \_\_\_\_\_. Please sign all future correspondence addressed to the organization with this number. You need not list your address unless it is different from the one in our records.

Another security measure employed by our organization is the use of mail drops. The mail drop is an address listed in a fictitious name of a person or company not connected with the organization. Each member is assigned one that he will use in sending all reports, correspondence, materials, etc., to the organization. Your assigned mail drop is:

We have a tremendous job ahead of us. Certainly, none of us pretend to know what the future holds for ourselves or for our native land. We do feel, however, that our freedom is gravely threatened. It is not always possible to know the best thing to do. But we do know this - our forefathers have given us a life of freedom and opportunity such as never existed before in all history. We must strive to pass this heritage on to future generations intact.

Our organization is not suggesting or doing anything more than Americans have always done - starting in 1776.

Enclosed is some further information about our organization, its history, objectives, and programs. Your record has been turned over to our training section and you should receive your first training program within two weeks.

Sincerely yours,

ARIZ.

~~MEMBER OF SUBJECT ORGANIZATION~~

Captain Patrick McDonald  
S. A. O. Headquarters Staff

CONFIDENTIAL

PRACTICAL SECURITY MEASURES

1. Use deceptive measures. Subscribe to one or more left-wing periodicals or get on the mailing list of some "peace movement". This will keep the postal inspectors guessing as to which side you are really on. While doing this our members can be of great assistance in searching this left-wing literature for names and addresses of fellow travelers and forwarding this information for our Central Intelligence files. We desperately need people to assist in this work. Please inquire as to detailed instructions for such activity.

2. Always use two envelopes in sending mail to any patriotic organizations or to any other member of our own organization. Do not put a return address on the outer envelope. Put your return address on the inside envelope with the words, "return postage guaranteed".

3. Place some opaque material such as tin foil, carbon paper, etc. between the inner and outer envelopes to prevent your mail from being read by infra-red cameras.

4. Send all letters from corner mail boxes or from post offices where you are not known.

5. Be careful in the use of the telephone. Avoid telephone calls to known members of the organization as much as possible.

6. Prepare telephone codes ahead of time for future protection.

7. In recruiting new members always learn as much as you can about the prospective recruit and make sure he is not an infiltrator before you identify yourself as a member of the organization.

8. Members of the organization in each area should be divided into four groups:

- A. Those who have been identified publicly or by law enforcement agencies as members of the Secret Army Organization.
- B. Those persons not known as members of this organization but who are generally known as being patriots.
- C. Those persons who have kept their political beliefs hidden.
- D. Members who profess to be liberal for the purpose of infiltrating enemy organizations.

All members should be very careful in making contact with persons in a different category than themselves. For example, people in Class D should be very secret in their contacts and communications with persons of Class A or Class

B. Each member must respect the security of every other member. Do not, under any circumstances, identify one member of the organization even to other members without his expressed permission on each and every occasion.

9. Avoid loose talk. Do not discuss organizational plans in public places where you could be overheard. Do not even hint at such a discussion in the presence of non-members.

10. Do not write patriotic letters to newspapers or magazines under your own name. To do so achieves very little except to identify you to the enemy.

11. If you are already known as a patriot, or as a member of this organization you may find it advisable to spread the rumor that you have become disillusioned with the right-wing or for you to pretend a gradual loss of interest.

12. Classify your various members addresses, your communications and your other activities as "top secret", "secret" or "restricted". Use your most secret lines of communication only for the most important messages rather than flooding them with unimportant material.

13. Demand obedience to all security measures from all members. Persistent disregard for security measures should be cause for disciplinary action.

14. Check your lines of communication from time to time by sending phoney messages to make certain they are not intercepted.

15. Change mail drops, meeting places, etc. frequently.

16. Prepare secret rendezvous points, mail drops, etc. now that may be used in time of some future emergency.

17. Each unit should assign some member the rank of Security Officer and should set up a system of fines or other penalties for failure to comply with security precautions.

18. Observe the "need to know" rule. Each member should be given only that information which is needed by him in the performance of his duty or which he will need in cooperating with other members of the unit. No member should feel "left out" because he is denied such information. Instead every member should willingly avoid information which he does not need.

19. Be careful that you are not followed in going to and from meeting places or in making contact with other members of the organization.

20. Keep all records and correspondence carefully hidden and in a manner that they can be easily destroyed. Records should be kept in code whenever possible.



# SECRET ARMY ORGANIZATION

## GENERAL HEADQUARTERS



Dear Fellow American,

Enclosed with this letter is your Preliminary Training Program. This first program is only a brief outline of some of the material that will be covered in later programs. There are four basic programs used by the Secret Army Organization: Intelligence, Security, Propaganda, and Recruiting, in that order. Each program will cost the new member \$3.00 and will take between one to three weeks to complete.

The correspondence training program serves a number of purposes, but the two major purposes are:

1. It lets us know which members of the organization have the patience and determination to finish assignments given them.
2. It lets us be certain that the members have the necessary basic training in intelligence, security, etc., which is essential to almost any important task which we could assign a member in underground warfare.

Proper training in these four basic skills is absolutely essential for every member of an underground army. A member may be an expert in survival techniques, use of weapons, urban warfare tactics and all the rest but experience has shown that without these other basic skills they seldom do much fighting - they just commit suicide.

For those of you who wish to become active and trusted members of the Secret Army Organization, let us emphasize again that the quickest way of doing so is to begin and diligently complete the basic training programs.

After you have completed the five work projects listed in the Preliminary Training Program send \$3.00 in to your regular mail drop and we will send you the first training program on Intelligence. In view of the urgent situation we now face some of our new members may receive special assignments after having completed the first two training programs. If this happens please try to redouble your efforts so that your special assignments can be taken care of while continuing to complete your regular training program.

SECRET ARMY ORGANIZATION

CONFIDENTIAL

6



# Secret Army Organization

## PRELIMINARY TRAINING LESSON

### Project No. 1

Look over the various books in your local public library that have been written on intelligence and espionage. Select two that seem best and read them carefully.

### Project No. 2

Write a brief outline of these two books and send it to your regular assigned mail drop or to General Headquarters.

### Project No. 3

Get in touch with one trusted friend that you do not ordinarily see too often. Preferably one that does not live in your present neighborhood. Inform him that he may, in the future, receive letters with an inner envelope with your name on it. Make sure he will keep these envelopes confidential and will secretly pass them on to you or hold them until you can pick them up. Let us know this alternate address in case we need to contact you in extreme circumstances.

### Project No. 4

Make necessary preparations to use a fictitious name for receipt of left-wing literature and correspondence. An important part of each members duties is to keep yourself and our organization informed on left-wing and communist activity in your area.

A phoney organization that includes the word "Peace" as part of its name is always a suitable cover. The address can be a P. O. Box, that of a friend, or even your own address. Mail several letters to the name and address you decide on to get the postal employees accustomed to it now. Then you will be ready to use it for the real thing.

### Project No. 5

While working in the library, place the enclosed Secret Army Organization leaflets in between the pages of various books where they will be found and read by others.

# Secret Army Organization

## PRELIMINARY TRAINING PROGRAM

It would be a mistake to think that our enemies have one set plan for the conquest of the United States. They are maintaining many continuous attacks on many fronts at the same time - political, education, business, labor, and even religion. They are continuously probing for weak spots in the defenses of our nation. During the past forty years so many openings have been left to them by the stupidity and collusion of our national leaders that they have been able to advance almost at will.

There is little we can do to change this situation at this time. Rather than deplete our limited resources on futile attempts to do so, we must concentrate on building a workable anti-communist underground army based on realities rather than wishful thinking and organized on the tried and proven principles of underground warfare.

The communists have fifty years experience in suppressing anti-communist underground activity. If we are to fight them successfully - if we are to hold out until the final victory of freedom over tyranny - then our underground army is going to have to be the most skillful and dedicated that the world has ever known. There is only one kind of member that can qualify for such an army - the very best!

This will require intensive training and practice. There is no short cut to perfection. By drawing on the talents of several of our more experienced members we think we now have a training program that can develop that kind of underground army.

In this program four different types of training will be involved:

1. Correspondence and printed material.
2. Tape recordings, picture slides, charts, etc., sold or loaned to S. A. O. units or members.
3. Actual experience - "On the job" training by carrying out assignments under supervision of more experienced members.
4. Training maneuvers - Due to the difficulty of keeping large training sessions secret the General Staff has decided that such training sessions will be held only for small select groups that have already completed sufficient preliminary training at the local level.

### INTELLIGENCE - SECURITY - PROPAGANDA

This preliminary training lesson is designed to give our members basic knowledge and practice in intelligence, security and propaganda. This first lesson is basic

preparation for advanced training in these three important activities which will be dealt with in greater detail further on in the training program.

### INTELLIGENCE

Underground warfare, as we customarily think of it, cannot succeed unless it is supported by a well developed organization comprising all the essential functions of intelligence, security, propaganda, communications, supply, medical services, etc.

Of all these, intelligence is most important. Let's consider one example: Suppose you picked up a telephone book, opened it up to any page at random, closed your eyes and put your finger on one name. Now suppose you read that name for the first time and said to yourself, "Sometime in the next 30 days I'm going to kill this man."

Consider the situation - one man, picked at random is marked for death. He might be the most powerful, the wealthiest, the most influential man in that city but none of these things would help him in the least. He would be defenseless. Why? Because you would have one thing that he did not have - intelligence. You would know his identity and he would not know yours. So long as that condition continued, there would be no possible way in which he could arrange an adequate defense against you.

Exactly the same situation exists between ourselves and our communist and socialist enemies. Our success will be directly proportionate to our knowledge of them and inversely proportionate to their knowledge of us.

Whatever a member's principal job may be in the Secret Army Organization, he must have a basic knowledge of intelligence techniques. This subject is therefore the first to be considered in our training program.

The word "intelligence", when used in a military sense refers to those methods that can be used to gain useful information. We usually think of this as knowledge of the enemy but it also includes information about the terrain, general population, available supplies and all other facts that will help in planning future activities.

Intelligence is roughly divided into three parts:

1. Observation. During a hot war this includes scouting and patrolling, observation of enemy troop movements, etc. On the cold war front this includes shadowing of enemy personnel, surveillance of enemy officers, tapping of telephones, interception of messages, etc.

2. Research and Analysis. Collecting and cataloging all possible useful information from general sources, newspapers, radio, trade magazines, etc., then matching up isolated scraps of information until an accurate picture is obtained of some situation that would not otherwise be known.

3. Espionage. This involves the placing or recruiting of agents within the enemy personnel where they can learn the enemy's plans first hand, steal the enemy's documents or materials, influence or misdirect the enemy's plans or policies.

Suppose you had a chance to see some important document for just a few minutes. How quickly could you scan it for its essential content? How well could you separate the important from the unimportant? Could you record this information in a written message that can be easily read and will not be misinterpreted?

Imagine that you are the leader of a patrol sent forward to observe and track an enemy column prior to a possible ambush. From time to time you will need to send back your observations in written form. Each S. A. O. member must develop the ability to put his thoughts on paper in such a way that they will be easily read and unmistakable.

The first two projects are designed to give the new member an opportunity to test these skills while learning ( or reviewing) basic elements of espionage activity. When these have been completed more advanced material will be furnished to the member directly. Useful intelligence projects of increasing complexity and importance will be assigned to those wishing to specialize in this work.

### SECURITY

It is obvious what a great advantage we can gain over our enemies by proper information about their plans and activities. It is equally true that much of this advantage will be lost unless we can keep our plans and activities secret from them. This is the basic purpose of all security activities. Overall security operations of an underground movement can be divided into five basic parts:

1. Protecting the identity of underground personnel and their families.
2. Keeping secret the location, movements and plans of underground units.
3. Keeping secret the location of underground headquarters, alternate hideouts and supply depots.
4. Protecting the identity of civilians, or individual members of the population that are friendly to underground forces.
5. Maintaining secrecy of communications.

As we have already said it is difficult to even guess what forms the coming conflict will take. Nevertheless, the strategy of all successful underground movements must satisfy these three basic principles:

First, is the "Principle of Deliberate Delay". During this state, the underground gathers its forces, checks its security, prepares its intelligence, establishes its lines of communications and waits for the enemy to become complacent and overconfident.

Second is the "Principle of Provocation". At the beginning of this stage only a few real patriots are willing to take part in underground activity. The vast majority of the population is still wishfully thinking that they can "get along" with the oppressive forces. They want only to be left alone and will not take action until they are personally threatened. During this stage the underground conducts a series of actions which provoke the enemy forces into making harsh repressive measures on the general population. This turns the general population against the oppressive forces and convinces them that the underground is really their only hope.

Stage Three may be called "Principle of Natural Allies". When the government's action against the general population becomes sufficiently brutal then large numbers of people will be willing to help or join the underground. Their reasons for doing so may be numerous and their ideology may not always be the same as the basic underground movement. During this stage minor differences between different underground groups must be minimized and all of our natural allies must be rallied to the cause of freedom.

The intelligence branch of our organization is well aware of the communist infiltration and control of the present United States government. It can rightly be said that we are now partially controlled by a foreign ideology. Thus, we are already engaged in Phase I of this conflict. How long this will continue until open warfare breaks out is anyone's guess. Once again, the best prediction of our intelligence department is that Stage II will last for several months, perhaps even years. This will be a time of assassination and counter assassination, terror and counter terror. During this phase the "average citizen" may avoid direct conflict at the price of his dignity and individual freedom. Known patriots will be in extreme danger.

For most people membership in the Secret Army Organization will not materially increase their danger during this time. For many years our enemies have carefully catalogued the name and address of every person who has ever written a patriotic letter to a newspaper. The membership lists of the more prominent "conservative" organizations have long been available to communist infiltrators in these organizations.

Continued activity and membership in other conservative organizations by members of the S. A. O. is desirable in many cases but those individuals should not identify themselves as members of the Secret Army Organization. For most of our own members it will be best if you do not take part in the activities of these other organizations. Although many of you are already "marked" men a certain degree of security can still be achieved by quietly dropping out of other right-wing activities and keeping your membership in the S. A. O. secret from all except your most trusted fellow members.

There may come a time when the average American is still able to go about his business with little regimentation but during which you as a known or suspected patriot, may be sought out for arrest or assassination.

CONFIDENTIAL

Project III listed at the end of this chapter may make it possible for the organization to contact you and render assistance should you ever find it necessary to go into hiding with little advance notice.

Project IV is a first step toward learning more about your enemies and at the same time, confusing them as to which side you are really on.

### PROPAGANDA

Another essential function of the underground is to convincingly inform the general public of what they stand for and thus gain the support of the general population. This must be done through propaganda, both written and spoken. Under conditions of enemy occupation the spreading of anti-communist propaganda would obviously be very dangerous. Even now there are certain phases of our propaganda effort that is best done by surreptitious means. Thus, observation, communication and propaganda are three elementary duties of every underground member.

Never before has propaganda been so important to the ultimate outcome of a major conflict. The ultimate object of any war is to force your desires on the minds of your enemies. Our enemies are attempting to do this by the non-violent means of psychological warfare.

12  
CONFIDENTIAL

Selection of weapons and supplies should give the Combat Team maximum flexibility to meet any condition that may be encountered in either rural or urban warfare. Consideration should be given to all possible situations that may develop relating to both traditional guerrilla warfare and modern underground warfare techniques. It should be kept in mind that the Combat Team is a functional part of a resistance network. Its activities should be coordinated with other teams to take maximum advantage of its striking powers.

Disregarding the inclusion of weapons peculiar to a given mission, the standard distribution of men and weapons could be as follows:

- #1 (Team Lieutenant) AR-180 Assault Rifle, automatic pistol, sheath knife, flare gun, and binoculars. 300 rounds of ammunition loaded in clips should be carried for the rifle, plus 50 extra rounds of ammunition for the pistol.
- #2 (Team Member) Riot Shotgun, automatic pistol, sheath knife, and wire cutters (with insulated handles). 100 rounds of No. 4 Buckshot in pouches for the shotgun, and 50 rounds of pistol ammunition.
- #3 (Team Member) AR-180 Assault Rifle, automatic pistol, sheath knife, and smoke grenades or flares. 300 rounds of ammunition in clips for the rifle, and 50 rounds of pistol ammunition.
- #4 (Team Sergeant) AR-180 Assault Rifle, automatic pistol, sheath knife, flare gun, and binoculars. Ammunition requirement is the same as #1 man.
- #5 (Team Member) M1903 Springfield Rifle with sniper scope, automatic pistol, sheath knife, and entrenching shovel. 100 rounds of AP ammunition in bandoleers for the rifle, and 50 rounds of pistol ammunition.
- #6 (Team Member) AR-180 Assault Rifle, automatic pistol, sheath knife, and 30 feet of climbing rope with grappling hook. Ammunition requirement is the same as #1 man.

ADDITIONAL MATERIAL

In addition to the weapons and supplies already listed each team member should have the following basic equipment:

- a. Sleeping bag and waterproof ground cloth
- b. Canteen ( 1 quart army type)
- c. Survival rations for three days
- d. First aid kit
- e. Gas mask with extra filter
- f. Flashlight with extra batteries
- g. Fatigue or camouflage clothing
- h. Combat or paratrooper boots

CONFIDENTIAL

- m. The team leaders will be responsible for maintaining the overall security of the unit. Personal feelings should not affect decisions involving reprimand or dismissal of men from the team for reasons that endanger its operation or security.
- n. Intelligence gathering as an important part of each team member's duties should be stressed. Information on the location and movements of local communist and left-wing enemies of the organization should be sent to either Regional or General Headquarters.
- o. The team leaders will be responsible for maintaining contact with higher command and for the transmission of orders from same.

### ORGANIZATION

The "Combat Team" will consist of six men. These six men will be divided into two sub-teams (Sections). Number One Section will consist of the Team Lieutenant and two other team members. Number Two Section will consist of the Team Sergeant and the two remaining team members. When completely assembled the unit will act directly under the command of the Team Lieutenant. When split into sections the Team Sergeant will carry out the orders of the Team Lieutenant during missions but will be in immediate command of the Number Two Section. In the absence of the Team Lieutenant the Sergeant will take command of the Unit.

### TRANSPORTATION

Transportation of the Combat Team will be effected by the use of two carriers. Interception and/or destruction of one carrier will not, then, immobilize the team. In addition, each carrier can serve as a scouting element for the other. Motorized carriers should be as inconspicuous as possible and still serve their purpose. Jeeps and pickup trucks should be used only where such vehicles are owned and used commonly by the general population or where the terrain makes their use necessary. Most often an ordinary passenger car will suffice. The model selected should have a good road clearance so it can be used on dirt roads. Tire chains (if needed), hydraulic jacks, extra gas, water, and suitable tools should be stored in the vehicle.

### TRAVEL PROCEDURES

Underway, Carrier #1 will lead and Carrier #2 will trail, The "interval" will vary with conditions. In cities close-aboard trailing will be used. Open road, by day, will require an interval of approximately 300 yards. At night this will be reduced to approximately 100 yards. During travel, all equipment (especially arms and ammunition) should be kept out of sight. Special team equipment and weapons should be locked in the trunk of the vehicle until needed. The trunk key should be carefully hidden so as to make it difficult to search the trunk in case law enforcement agents should stop the car on some pretext with the intention of searching it illegally.



# THE COMBAT TEAM

CONFIDENTIAL

## General Outline

The "Combat Team" is the smallest organizational unit used by the Secret Army Organization. When organized in the proper manner it is capable of operational initiative when detached from the parent organization. When developed to its highest degree of efficiency the Combat Team is almost totally self-sufficient and able to perform any one of several missions. To attain these aims the following elements are essential:

- a. Equipment should be well-chosen and standardized as much as possible.
- b. Communications, internal and external, must be capable of rapid transmission, be varied in nature, and be exercised with prime emphasis on security.
- c. Internal coordination should be automatic in response. Confidence among members of the team must be developed.
- d. Selection of each position on the team should be based on psychological aspects as well as technical competence.
- e. Training of the men in each function should be at regular intervals and continuous. Field problems should be given dry runs in detail.
- f. The logistics problem should be studied with care, and made simple and direct.
- g. Each team will have a "leader" (Lieutenant) and an "assistant leader" (Sergeant). These men shall be given special training by the Secret Army Organization at "leadership seminars".
- h. Team "marshalling points" should be selected in advance and be well defined. Practice "alerts" will determine the team's efficiency in response and security.
- i. Terrain familiarity within the expected operational radius of the team must be developed.
- j. Weapons familiarity must be obtained through live firings at various targets. Team action must be stressed as well as individual competence.
- k. The team leader should see that a constant flow of information is provided to team members on the ideological struggle. This will help induce the proper frame of mind in each member.
- l. Team missions and targets must be identified and the proper training equipment made available for each assignment.

CONFIDENTIAL

## MEMBERS REPORT FORM

CONFIDENTIAL

Please fill out and return to your assigned mail drop as quickly as possible. If you have not yet been assigned a regular mail drop, Mail to: P. O. Box 5791, San Diego, California 92105.

CODE NAME OR IDENTIFICATION NUMBER: \_\_\_\_\_

ADDRESS: \_\_\_\_\_ ZIP CODE: \_\_\_\_\_  
(Only if changed from last month)

BASIC CORRESPONDENCE TRAINING PROGRAM: (Enclose \$3.00 for each program)

Intelligence       Security       Propaganda       Recruiting

Special Note: Each program must be ordered only upon completion of the prior program. Enclose payment when ordering each program.

SECRET ARMY ORGANIZATION MATERIALS:

S. A. O. Stickers (50 for \$1.00)       S. A. O. Leaflets (50 for \$1.00)

Other Materials Needed: \_\_\_\_\_  
(Recruiting forms, Histories, Etc.)

S. A. O. DUES FOR \_\_\_\_\_ CONTRIBUTION TO S. A. O. \_\_\_\_\_

S. A. O. DUES FOR \_\_\_\_\_ MATERIALS \_\_\_\_\_

TOTAL ENCLOSED \_\_\_\_\_

DESCRIBE BRIEFLY YOUR ACTIVITIES PERTAINING TO THE ORGANIZATION DURING THE PAST MONTH:

16  
CONFIDENTIAL

CONFIDENTIAL

# JOIN THE SECRET ARMY ORGANIZATION

*An organization of loyal Americans  
dedicated to the preservation of both  
national and individual freedom.*

1. To prepare the means of personal defense and survival in case of enemy attack.
2. To resist and expose the spread of communist influence and propaganda within our own national boundaries.
3. To investigate by means of our own secret memberships the infiltration of communist sympathizers into American organizations of government, business, labor, religion and education.
4. To resist by any and all means the passage of laws which regulate the private ownership of firearms or which detract from the individual's ability to defend his own family and personal property.
5. To promote knowledge and skill in the use of arms by our own members and by the general public.
6. To form in advance of actual need a secret underground organization equipped to spy upon, harass and destroy troops of any foreign power that might occupy United States territory.
7. To lend assistance and support wherever possible to other resistance organizations, domestic or foreign, opposing communist expansion or subversion.
8. To pursue these programs as private citizens motivated only by patriotism and to remain entirely free of government subsidies or control.

The Secret Army Organization is a national organization of patriotic Americans who are preparing themselves as a last line of defense against communism. To exemplify the necessity of such an organization, we quote the 1960 Annual Report of the Committee on Un-American Activities as follows:

"Events of the past year have provided convincing evidence that the American people cannot rely completely on this country's armed forces to protect themselves from communist domination and slavery. This is not because our military forces lack the power or the will to defend this country, but rather because the nature of the attacks being made on the United States by its major and only significant enemy are so designed as to render conventional military forces as ineffective as possible for defense purposes."

Starting from nothing 50 years ago, communism now rigidly controls one-third of the human race and has subverted to varying degrees the remaining two-thirds. In the past 20 years the communists have conquered 20 sovereign nations, one by armed conquest and 19 by internal subversion or negotiation.

There is not one of these countries in which the communists rule by the consent of the people. Everywhere they must perpetuate themselves by terror. They remain in power only through the use of the most brutal police state tactics.

The communists consider their party workers not simply as an accessory to armed conquest but as the actual spearhead of any invasion into new territory. From this point of view the United States was "invaded" by Soviet troops more than 30 years ago. It has been authoritatively estimated that the communists now have an army of 500,000 combatants already landed on American shores and already working by the most insidious means to destroy our American way of life.

The cold war is very real. It must be fought and won. The only alternative is to lose and to lose means that future Americans for generations to come must live in terror and in slavery. Appeasement is futile. We cannot bargain with moral barbarians who never have and never will know the meaning of honesty.

Communism must be defeated, not merely resisted. We must rid our country of traitors and fellow travelers. We must embark on a massive offensive turning every communist trick - from propaganda to infiltration - against our mortal enemy. This is the one and only way to win the struggle for survival.

Send 20¢ in coin or stamps for full information on the Secret Army Organization programs and membership application to: S. A. O., P. O. Box 5791, San Diego, California 92105.

CONFIDENTIAL

17

# Secret Army Organization

## TRAINING PROGRAM

CONFIDENTIAL

### INTELLIGENCE

We are faced with a dangerous enemy who has repeatedly boasted of his plans to destroy our Constitutional Republic and to enslave our people.

For more than forty years they have been infiltrating their agents into the most sensitive areas of labor, press, entertainment, education, law, communications, religion, industry and government. The degree of their success is made obvious by our government's failure to oppose communism internationally and by our fellow citizens' lack of interest in their own preservation.

We already know a considerable amount about this enemy; their origin, objectives, approximate strength, organizational structure and general methods of operation.

There are four areas where we especially need additional information:

1. Details of the techniques used in espionage, infiltration and subversion by individual agents, including the methods by which they control their fellow travelers.
2. The equipment used for surveillance, communication, assassination, sabotage, etc., by individual enemy agents.
3. Working details of their short range programs either in operation or planned for the near future.
4. The actual identity of enemy agents, fellow travelers and sympathizers along with details regarding their work, place of residence, cover operation, means of transportation, travel pattern, personal appearance, mental characteristics, personal lives, business and organizational activities.

Our ultimate victory or defeat may depend on our ability to obtain enough of this vitally important information.

There are literally thousands of sources from which bits of valuable information can be obtained. These range from such extremes as the local newspapers to documents stolen from the enemy's guarded vaults.

CONFIDENTIAL

The methods of gathering intelligence are roughly divided into two groups: 1) Research and Analysis, and 2) Espionage.

Espionage includes all the "illegal" means of obtaining information, such as wire-tapping, interception of mail, stealing of documents, secretly photographing records, infiltrating spies into enemy organizations, bribing or blackmailing individuals of the enemy apparatus.

Research and Analysis includes the careful systematic search of all newspapers, magazines, trade journals, house organs, political pamphlets, books, public records, etc., to sift a few "needles" of valuable intelligence from several "haystacks" of general information.

Professional intelligence organizations obtain about 95% of their information from Research and Analysis and only about 5% from Espionage. When espionage techniques are used, they prove most effective when a specific mission is carefully planned out in advance which takes advantage of all possible background information that may be obtained by research methods.

Let's examine how these various techniques might be used to obtain additional information of the four basic types we need most.

1. Details of the techniques used in espionage, infiltration and subversion by individual agents including methods by which they control their fellow travelers.

An agent trainee may learn something of the general espionage methods used by communist agents who have defected from the party and have then written about their experiences. Beyond this they are of very little value. The actual details of such techniques are uniformly neglected.

More useful information can be obtained from the study of past court records in which evidence has been presented in espionage cases. Hints and clues may occasionally be picked up from continuous and careful study of the regular news media. Really basic information of this type, however, must be obtained by infiltration and espionage techniques.

2. The equipment used for surveillance, communications, assassination, sabotage, etc., by individual agents.

Hints about the type of hidden microphones, short wave transmitters, miniature tape recorders, etc. used in surveillance and communication by espionage agents sometimes are mentioned by chance in the regular press or news magazines, in connection with reported spy cases. Technical details and construction plans occasionally are given in the electronics or "Popular Science" type magazines. Other information may be requested directly from the manufacturers of such equipment.

The type of short acting or long acting poisons best suited for assassination under various conditions might be anticipated by a careful study of toxicology; from "Chemical Abstracts" and Biological Abstracts"; from current magazines on pharmacology, as well as from such magazines as "Scientific Monthly" and "Science Newsletter", all available from larger city libraries.

Information on explosives is available from ordinance journals, literature from manufacturers, technical books, mining and drilling magazines, etc.

Naturally, such special fields of interest are best pursued by some person who already has an aptitude in each particular line.

This is one of the things that makes us feel that the American people are uniquely equipped to form a deadly effective underground. Nowhere else in the world does any population have as many useful hobbies and avocations that could be adapted to underground warfare. Many by products of these hobbies can be used as sabotage instruments. Just one typical example - the dust from grinding wheels in metal shops should be saved to mix with grease for the bearings of enemy machinery.

### 3. Working details of their immediate and future plans and activities.

Advance information about "peace marches" and racial demonstrations can be had by subscribing to appropriate communist front publications. Details as to the size of the demonstration and degree of violence anticipated must be obtained by infiltrating such organizations. Communist plans for future propaganda campaigns, subversion, espionage, blackmail of government officials, etc., may be learned directly by infiltration or may be deduced from a close study of their past activities.

### 4. Identity and personal information about enemy agents.

This requires the full scope of counter espionage activity; research and analysis of enemy publications, monitoring of communist sponsored meetings, surveillance of party offices, infiltration of enemy apparatus, recruitment of double agents, interception of enemy communications, etc., etc.

## TECHNIQUES OF EFFECTIVE RESEARCH

1. Every researcher should be constantly on the alert for useful information in the general news media - radio, TV, magazines, etc.

2. Each researcher should have one field of interest to which he gives special attention.

20  
-8-

For example:

One researcher might read every book available on "escape and evasion" and all the stories or articles written on prison escapes, looking for ideas that might someday help our members escape from a concentration camp.

Another researcher might continuously search the communist front publications for names of fellow travelers; for announcements of future meetings, rallies or similar activities; for additional information that would tie suspected communists to known communist organization; for friendships, business connections and family relationships between known communists and unknown communists.

Each city should have one researcher that carefully reads the daily papers to extract such information as: names of speakers at left wing meetings, names and addresses of both left and right wing letters to the editor, social functions attended by known communists, names of persons who might be potential recruits, news of coming "peace marches" and similar demonstrations, expressions of either pro or anti communist sentiments by local public officials, educators, businessmen, ministers, etc., evidence of communist inspired violence, sabotage or blackmail.

There is an almost endless variety of areas that need to be covered. Based on his or her own interests and abilities each researcher should choose the specialty for which they are best qualified.

3. Be as specific as possible. Look for details. Include blue-prints, drawings or photographs of all technical equipment when possible. Don't expect your analyst to be a "mind reader". Include all the facts. Continuously ask yourself the questions: Would this information be of value to the Secret Army Organization? To individual espionage agents? To other members? To our technical specialists?

4. Avoid editorial opinions and general news items as these are of little value and needlessly swamp our limited staff of analysts.

5. Do all the work locally that you possibly can. If the person is local, look them up in the telephone book or cross index. Double check to make sure the address is correct and that they still live there. Type cards if possible, otherwise, print plainly. Include phone numbers and licence numbers of cars whenever possible.

6. Use standard 3 x 5 inch index cards for sending in information on individuals. Clip pages of magazines or photostat important articles. In outlining books, be sure important facts are fully covered.

7. Always state the source of all information reported to the organization.

Printed below is a sample index card showing the proper placement of information. Use it as a guide when making out your cards.

/Smith, John D.

December 1, 1970

Home Address: 657 Riverside Drive  
Los Angeles, California 90000  
Telephone: 222-3333

Automobile: 1968 Ford, Green 4-Door, Lic. No. CAL 555

Activities: Gave a talk against war to the Santa Ana Chapter of the Peace and Freedom Party. Smith is a full Professor of Political Science at UCLA. (source: Los Angeles Times, page A-4, November 28, 1970)

XXXX  
(member's ID number)



## INTELLIGENCE

## WORK PROJECTS

1. Write to the following "peace publication" (most of them are actually communist fronts) and ask for subscription price and a sample copy.
- 
- 
- 

(A) When these sample copies are received by you, proceed to make out an index card on each person mentioned as supporting or taking part in any peace organization. Do not forget to include the magazine staff (editor, circulation manager, authors, etc.) Include a description of the position held or activity referred to for each.

(B) Analyze the propaganda content of each magazine - in what way does it serve the communist cause? When completed, send these magazines in to your regular assigned mail drop along with your index cards, comments and analysis.

2. Using your fictitious name, write to the following "peace organization". Tell them you are concerned about the world situation and would like to help in the peace movement. Ask for the location of their nearest headquarters or a local member you could contact, as well as further information about their organizational plans and objectives.
- 
- 
- 

(A) Make out index cards on all persons listed on their letterhead and in their literature.

(B) Analyze their propaganda literature and forward it to your regular mail drop along with your comments on how this particular organization promotes communist objectives.

(C) Send a note to let us know what research specialty you feel best qualified for and what plans you are making to gain useful information in this field.

[Redacted Box]

CODE NAME: \_\_\_\_\_

ASSIGNMENT: \_\_\_\_\_

RANK: \_\_\_\_\_ SECURITY RATING: \_\_\_\_\_

CONTACT: \_\_\_\_\_

E G F P D  
Active Grade

Correspondence Training Programs	Intelligence			Security			Propaganda			Recruiting		

Year	Jan	Feb	Mar	Apr	May	June	July	Aug	Sept	Oct	Nov	Dec

24



UNITED STATES DEPARTMENT OF JUSTICE  
FEDERAL BUREAU OF INVESTIGATION

Phoenix, Arizona  
December 22, 1971

In Reply, Please Refer to  
File No.

Title                      Secret Army Organization

Character

Reference                  Memorandum dated and captioned  
as above at Phoenix, Arizona.

All sources (except any listed below) whose identities are concealed in referenced communication have furnished reliable information in the past.

This document contains neither recommendations nor conclusions of the FBI. It is the property of the FBI and is loaned to your agency; it and its contents are not to be distributed outside your agency.

UNITED STATES GOVERNMENT

# Memorandum

TO : DIRECTOR, FBI

FROM : SAC, LAS VEGAS (157-997) (P)

SUBJECT: SECRET ARMY ORGANIZATION  
EXTREMIST MATTERS  
OO: San Diego

DATE: 12/6/71

*Regent*

Re Phoenix letter to the Bureau, 10/22/71 and Bureau letter to Phoenix, 11/9/71. (Not received by Oklahoma City)

Enclosed for information of Oklahoma City is one copy each of referenced letters with enclosure. (Phoenix LHM dated 10/22/71)

Referenced letters indicated that JOE BURTON and (FNU) DOYLE, Las Vegas, Nevada were knowledgeable concerning captioned organization although they were not identified as being participants in the clandestine meetings held in Yuma, Arizona concerning this organization.

A review of Las Vegas files indicates that JOE BURTON is probably identical to JOHN OWEN BURTON, aka, a former SI subject of the Las Vegas Office because of his past Minutemen activities. In March, 1971, Oklahoma City became origin in the BURTON case after investigation showed that he had permanently changed residence to Tulsa, Oklahoma. (Bureau file 100-448471, Oklahoma City file 157-975).

Las Vegas files further indicate that (FNU) DOYLE is possibly identical to JACK CONAN DOYLE, JR. (Las Vegas file 157-553, Bureau file 105-175539). DOYLE in 1965-66 was a self-admitted member of the Minutemen. Investigation showed that subject dropped out of the organization in 1968 and has had no further association with it since that time.

- (2) - Bureau
- 2 - Kansas City
- 2 - Oklahoma City (Enc. 2)
- 2 - Phoenix
- 2 - San Diego
- 3 - Las Vegas
  - (1 - 157-997)
  - (1 - 157-529)
  - (1 - 157-553)

REC-51

157-23577-3

DEC 10 1971

REC 20 1971

DEC 10 1971

WLK:bsh

(13) DEC 27 1971

EXT. 12/10/71

Buy U.S. Savings Bonds Regularly on the Payroll Savings Plan

100-448471-13  
105-175539

UNRECORDED COPY FILED IN



LV 157-997

It is noted that BURTON has been described as a "dangerous man" and "unstable" who reportedly is armed at all times. An informant stated that BURTON would not only engage in violence but would probably provoke it.

JACK CONAN DOYLE, JR. has been described by sources as a person likely to provoked into irresponsible acts of violence and is not above using violence. In addition, the file reflects that DOYLE has a working knowledge of explosives, particularly dynamite and has been an amateur miner. In January, 1966, he allegedly gave a demonstration in the use and handling of dynamite, safety fuse, primer cord and blasting caps at a local Minutemen training session held in the Nevada desert near Las Vegas.

Sources and informants cognizant of Minutemen activity in the Las Vegas Division have been contacted and no positive information has been developed to date.

LEADS:

OKLAHOMA CITY DIVISION

At Tulsa, Oklahoma:

Will, through appropriate sources, determine if JOHN OWEN BURTON is active in captioned organization.

PHOENIX DIVISION

At Phoenix, Arizona:

Will, through additional contacts with [redacted] attempt to determine if BURTON or DOYLE are currently associated with SAO, or if their names were mentioned because of their past Minutemen activities.

LAS VEGAS DIVISION

At Las Vegas, Nevada:

Will contact additional sources re Secret Army Organization.

LV 157-997 .

2. Will re-open DOYLE case and conduct investigation to determine if he is known to be active in captioned organization.

UNITED STATES GOVERNMENT

# Memorandum

TO : DIRECTOR, FBI (157-23577)

FROM : SAC, PHOENIX (157-1173) (P)

SUBJECT: SECRET ARMY ORGANIZATION  
EXTREMIST MATTERS  
OO: SD

DATE: 12/17/71

Re LV letter 12/6/71.

Contact with

**PROTECT INFORMANT**

obtained additional

organizational material pertaining to captioned organization. This is being made the subject matter of a letterhead memorandum, which is being submitted by separate letter.

Concerning JOHN OWEN BURTON and JACK CONAN

*MA*  
DOYLE, Jr., informant advised that he has not met BURTON or DOYLE, and that all he can report about them at this time is that the names "JOE" BURTON and JACK DOYLE stand out vaguely in his memory as names mentioned at the meeting in Yuma on 10/16/71; these were people who know about the formation of the Secret Army Organization. No indication of current activity on the part of these two individuals can be inferred from this recollection; on the other hand, informant states they must have potential as interested recruits, otherwise, their names would not have been mentioned in context. In this connection, informant indicated that he will undoubtedly learn more about BURTON and DOYLE one way or the other as the organization develops.

- 2 - Bureau (RAM)
- 2 - Kansas City (info.) (RM)
- 2 - Oklahoma City (info.) (RM)
- 2 - Los Angeles (info.) (RM)
- 2 - San Francisco (info.) (RM)
- 2 - Seattle (info.) (RM)
- 2 - San Diego (RM)
- 3 - Las Vegas (RM)
- 2 - Sacramento (info.) (RM)
- 2 - Phoenix (157-1173) (170-37A)
- (157-997)
- (157-529)
- (157-553)

CLC/pas  
(21)

EX-112

REC-8

157-23577-2  
100806

DEC 20 1971



DEC 28 1971

Buy U.S. Savings Bonds Regularly on the Payroll Savings Plan

SEC.

PX 157-1173  
CLC/pas

## PROTECT INFORMANT

For the most part, the recruiting has been in California for the SAO, but some recruiting is taking place presumeably in the State of Washington, inasmuch as "Sam" makes reference to "our friend in Washington", and that "our friend in Northland said that his people are real hot for the idea of starting a branch."



SAC, Phoenix

- 1 - Mr. L. G. Brockman
- 1 - Mr. J. O. Ingram

11/9/71

REC-60 Director, FBI (157-23577)

SECRET ARMY ORGANIZATION  
EXTREMIST MATTERS

EX-10

RePXlet 10/22/71.

For information of Kansas City, five individuals met clandestinely in a motel in Yuma, Arizona, on October 16 and 17, 1971, and a discussion was held on reorganizing the Minutemen under the same basic tenets but under a new title, "Secret Army Organization." The five known individuals used first names only and traveled to this meeting from San Diego, Seattle, Las Vegas and Phoenix. The five were identified as Jerry Davis, also known as Sam Davis from San Diego. Two individuals from San Diego were also named Barry and Stan, and one individual named Si from Seattle and Everett from Phoenix.

The mail drop for the organization will be in care of Howard Clark, 1080 6th Street, Ramona, California 92065. Names mentioned in course of meeting as being knowledgeable about the new organization were Joe Burton, Las Vegas, and FNU Doyle, Las Vegas. This information was obtained by PX 783-E and group was interested in establishing the availability of automatic weapons.

Bureau indices contain no identifiable record regarding above organization. No identifiable data located regarding individuals mentioned above based on data furnished with exception of Howard Francis Clark. San Diego and Kansas City refer to case entitled, "Howard Francis Clark, SM - Minutemen," wherein it is reported subject has been involved in white-hate activities in past.

MIA  
MST

- Tolson \_\_\_\_\_ 2 - Kansas City
  - Felt \_\_\_\_\_ 2 - Las Vegas
  - Rosen \_\_\_\_\_ 2 - San Diego
  - Mohr \_\_\_\_\_ 2 - Seattle
  - Bishop \_\_\_\_\_
  - Miller, E.S. \_\_\_\_\_
  - Cullahan \_\_\_\_\_
  - Casper \_\_\_\_\_
  - Conrad \_\_\_\_\_
  - Dalbey \_\_\_\_\_
  - Cleveland \_\_\_\_\_
  - Ponder \_\_\_\_\_
  - Bates \_\_\_\_\_
  - Tavel \_\_\_\_\_
  - Walters \_\_\_\_\_
- 1 - 100-451595 (Howard Francis Clark)
- FOI: ank
- (14)

Can

MAILED 5  
NOV 8 1971  
FBI

Get 7/10/72  
EX-10

SEE NOTE PAGE TWO

Letter to Phoenix  
Re: Secret Army Organization  
157-23577

Recipients conduct discreet preliminary-type inquiry through established sources to determine aims and objectives of organization and identities of officers. Determine additional plans for meeting. Phoenix through ~~Phoenix~~ determine additional information regarding meeting and review records of motel in Yuma and attempt to further identify individuals present at meeting. Phoenix furnish Kansas City, office of origin in Minutemen matters, additional background regarding meeting and material distributed at meeting.

San Diego is designated office of origin since headquarters or mail drop for organization at present is at Ramona, California. San Diego, Seattle and Las Vegas open separate cases on individuals attending meeting to completely identify these persons and obtain background to determine weapons in their possession at present, and their propensity for violence. Bear in mind possible gun law violations since individuals have indicated interest in the availability of automatic weapons. Appropriate informants should be targeted by recipients to obtain advance intelligence data regarding possible violence of this new group.

Kansas City canvass white-hate informants familiar with Minutemen activity to determine if in possession of information of new secret organization.

Recipients submit results of investigation in a form suitable for dissemination.

NOTE:

~~Phoenix~~ furnished information of the formation of a new white-hate organization and this meeting appears to be the first official organizational meeting of this group. Phoenix in referenced letter set forth leads to San Diego, Seattle and Las Vegas Divisions to establish the identity of individuals and to obtain background of formation of new organization at secret meeting held at Yuma, Arizona, in October.

UNITED STATES GOVERNMENT

# Memorandum

TO : DIRECTOR, FBI

DATE: 10/22/71

FROM : SAC, PHOENIX (157-NEW) (P)

SUBJECT: SECRET ARMY ORGANIZATION  
EXTREMIST MATTERS

There are enclosed to the Bureau and to interested offices a letterhead memorandum pertaining to captioned organization. Five copies of the LHM are designated for the Bureau and three copies are designated for pertinent field offices.

The confidential informant who furnished the information contained in the LHM is [redacted] who furnished the information on 10/18/71 to the Phoenix office.

## PROTECT INFORMANT

It is, therefore, recommended that the LHM not be disseminated outside the Bureau. No dissemination is being made at Phoenix. It is felt that this could be done at a later date when the organization has been developed in more concrete form.

Phoenix' informant advised that the individuals spearheading the organization of the Secret Army Organization seemed to be SAM DAVIS, aka JERRY DAVIS, together with (FNU) BARRY, both of San Diego. The mail drop for the organization will be care of HOWARD CLARK, 1080 6th Street, Ramona, California 92065. Informant advised that (FNU) STAN seemed to lack enthusiasm for the new organization, and seemed to be more politically oriented along the lines of the American Nazi Party. Informant himself took a cautious stand toward the deliberations of the group. Names mentioned in the course of the meeting as being knowledgeable about the new organization are: JOE BERTON, Las Vegas, Nevada; and (FNU) DOYLE, Las Vegas, Nevada.

- 2 - Bureau (Enc. 5) (RM)
  - 2 - San Diego (Enc. 3) (RM)
  - 2 - Seattle (Enc. 3) (RM)
  - 2 - Las Vegas (Enc. 3) (RM)
  - 2 - PHOENIX: [redacted] SEC. [redacted] TRS
- CLC/jsh DEPT: ISD, IDIU, ED

(10) HOW FORW: \_\_\_\_\_  
DATE FORW: \_\_\_\_\_

Buy U.S. Savings Bonds Regularly on the Payroll Savings Plan



5010-108

*See Stanley*

*Handwritten notes and signatures:*  
- Top right: *W.C. [unclear]*  
- Middle right: *W.C. [unclear]*  
- Bottom right: *Del [unclear]*  
- Far right: *Group*

*Handwritten notes:*  
- *4/11/70*  
- *1/16/71*  
- *1/9/71*  
- *12/20/70*

*Handwritten notes:*  
- *rd*  
- *217*

ST-103 REC 9

23577

18 OCT 26 1971

EXT. INT. SEC.

PX 157-NEW  
CLC/jsh

Source made reference to the opening paragraph in the "HISTORY OF THE SECRET ORGANIZATION" material attached to this LHM wherein a group of six Minutemen allegedly met in Northern Arizona in February 1970. Based on the general tenor of the conversations at Yuma incidental to the organizational meeting there informant feels that the meeting he attended at Yuma is the first official organizational meeting of the group. The assassination of Minutemen leader has reference to TROY HAUGHTON, former State Coordinator of the Minutemen in California, who has been missing approximately three years.

Source advised that the organizing group mentioned in the attached LHM met in Yuma for the purpose of having access to the gun show that took place at the Fairgrounds there on October 16 and 17, 1971, under the sponsorship of the Kiwanis Club. This organizing group is interested in establishing the availability of automatic weapons.

LEADS:

The SAN DIEGO, SEATTLE and LAS VEGAS DIVISIONS will through confidential sources establish the full identity of the individuals who met in secret at Yuma, Arizona, on October 16, 17, 1971, in connection with this matter.

The LHM is being classified CONFIDENTIAL to protect the identity of source, who is of continuing value and whose exposure could be detrimental to the national defense.

*called  
As Offices  
ATTENTION  
Su N -  
LAW  
violations  
by LET  
11/9/71  
JD*



UNITED STATES DEPARTMENT OF JUSTICE

FEDERAL BUREAU OF INVESTIGATION

CONFIDENTIAL

In Reply, Please Refer to  
File No.

Phoenix, Arizona  
October 22, 1971

SECRET ARMY ORGANIZATION

On October 16 and 17, 1971, a coterie of five men met clandestinely in a motel in Yuma, Arizona, and oriented themselves with the plans and process of reorganizing the Minutemen under the same basic tenets but under the new name "Secret Army Organization". PX T-1 advises that the five known individuals who attended this meeting used first names only and traveled to this meeting place from San Diego, California; Seattle, Washington; Las Vegas, Nevada; and Phoenix, Arizona. The five are identified briefly as follows:

Name

Address

Race

Sex

Nationality

Height

Weight

Age

Name

Address

Race

Sex

Nationality

Height

Weight

Hair

Miscellaneous

MEMBER OF SUBJECT ORGANIZATION

Jerry Davis, also known  
as Sam Davis

From San Diego

White

Male

American

5'8"

150 pounds

Age 33 (Approx.)

CALIF

B. approx 1938

(FNU) Barry

From San Diego

White

Male

American

5'10"

175 pounds

Brown

Wears glasses

CALIF

CONFIDENTIAL

GROUP I

EXCLUDED FROM AUTOMATIC  
DOWNGRADING AND DECLASSIFICATION

157- 23577 - 1

ENCLOSURE

CONFIDENTIAL

SECRET ARMY ORGANIZATION

Name  
Address  
Race  
Sex  
Nationality  
Height  
Weight  
Hair  
Eyes  
Build  
Miscellaneous

(FNU) ~~Stan~~  
From San Diego CALIF  
White  
Male  
American  
6'1"  
225 pounds  
Short brown hair  
Hazel  
Stocky  
Wears small goatee

Name  
Address  
Race  
Sex  
Nationality  
Height  
Weight  
Hair  
Eyes  
Build

(FNU) ~~Si~~  
From Seattle, Washington  
White  
Male  
American  
6'1"  
235 pounds  
Short, light brown  
Blue  
Pudgy

Name  
Address  
Race  
Sex  
Nationality  
Height  
Weight  
Hair  
Miscellaneous  
Age

(FNU) ~~Everett~~  
Phoenix, Arizona  
White  
Male  
American  
5'10"  
190 pounds Biappily 1933  
Brown  
Wears glasses  
38 (Approx.)

Source furnished the following four items of printed material, which had been prepared before the meeting for recruitment purposes and for dissemination to prospective

- 2 -

CONFIDENTIAL

CONFIDENTIAL

SECRET ARMY ORGANIZATION

members for captioned organization; this material is self-explanatory as to a statement of principles for the organization and is being made an appendage of this memorandum.

This document contains neither recommendations nor conclusions of the FBI. It is the property of the FBI and is loaned to your agency; it and its contents are not to be distributed outside your agency.

- 3\* -

CONFIDENTIAL

# History of the Secret Army Organization

CONFIDENTIAL

One early morning in February, 1970, a group of six Minutemen leaders from four states met secretly in Northern Arizona to discuss the crisis that the arrest and imprisonment of two top Minutemen leaders and the assassination of a third had brought on the organization. Although some of these men had met before in their roles as Minutemen group leaders, others were meeting for the first time.

After much discussion, two principal points were agreed upon. First, that the Minutemen as a national coordination organization of militant right-wing groups had effectively been destroyed by the pro-communist elements inside the Justice Department. While individual units still existed throughout the country, few had the financial support or leadership to be really effective. Second, that the need for such a coordinating organization was greater than ever in view of the increased revolutionary activity by communists in the United States.

With these two points in mind, suggestions were put forward on a course of action to be followed. After a meeting that lasted all that day and far into the next morning, an overall plan of action was finally agreed upon. All present agreed to merge their individual units together and form a new organization under the command of one leader elected from among themselves, with the other five to be members of a General Staff that would advise and assist the new leader.

While retaining the basic programs and policies of the Minutemen, it was decided that not only should this new organization have a different name, but also a completely new chain of command and organizational structure. If the new organization was going to survive the attacks that befell the old one, a whole new approach would be needed. Never again could the arrest or death of a few leaders be allowed to cripple the entire organization.

For this reason it was decided that only a highly disciplined military type organization with a definite chain of command would have any chance of success. This then, was the beginning of the Secret Army Organization. Beginning with an original force of hard core patriots that numbered fewer than two hundred, the Secret Army Organization began the job of picking up the pieces and continuing to fight for national and individual freedom. Using this cadre of dedicated personnel as a nucleus, the S. A. O. has been recruiting and training new members in the skills they will need as the freedom fighters of tomorrow.

The leaders of the S. A. O. have no idea of fighting a last ditch stand. We have no desire to commit suicide ourselves or to let our members do so. We have a strategy which we believe will ultimately lead to victory. Only one thing is essential. We must start preparing and training NOW! We of the S. A. O. believe that our country is worthy of any sacrifice. If you feel the same way, we invite you to join us.

CONFIDENTIAL



To: Respective Members Of The  
SECRET ARMY ORGANIZATION

CONFIDENTIAL

The Secret Army Organization is the most active, most completely dedicated and most selective in its membership of all the many patriotic organizations in America. We are willing to make any sacrifice for our country and we fully expect that some of us will have to make the ultimate sacrifice before victory is achieved. Our very lives depend on each other. There is no place in this organization for bunglers, playboys or lukewarm conservatives. If you join the Secret Army Organization, there might easily come a time that your life would depend on how competently some other member had learned his job.

Unless you are especially well informed on the domestic and world political situation, it is probable that you have a lot to learn about the present threat our nation faces. Unless you have had many years experience in actual underground warfare, there is undoubtedly a lot you can learn from the experts in our organization who have developed and supervised our training program.

### OUR NATION IS IN IMMEDIATE DANGER

It is possible that within a very few years, perhaps even within months, our nation could be conquered and enslaved by the communists. To prevent this we must know as much as possible about our enemies. Unless we know who they are and what they are doing we will not succeed in our efforts to maintain a free America.

### THE RESISTANCE MOVEMENT

In driving an invader from your land the resistance involved goes through three stages of development.

- 1) The Underground Network
- 2) Active Guerrilla Warfare
- 3) Open or Conventional Warfare

The conventional warfare stage uses everything in the way of weapons that the enemy does but must also have active guerrillas and underground agents working against the enemy, too. In the present state of military tactics conventional warfare cannot succeed unless these other two ingredients are used simultaneously.

The first step is to form an underground network. An active guerrilla system must have the support of an underground network of approximately three times its own size. This underground must supply the active guerrilla fighter with supplies, concealment, information, etc. An underground network starts with departments of intelligence, security and propaganda in that order.

Sabotage, espionage, subversion, infiltration, escape and evasion, training, clandestine fabrication of supplies, counterfeiting enemy documents, recruiting, communications and propaganda are other phases of underground activity. Each member of the Secret Army Organization, to be effective, must have a working knowledge of all these tactics as well as the military tactics more commonly associated with guerrilla activities.

CONFIDENTIAL

## ASSIGNMENT TO UNITS

CONFIDENTIAL

Many people that inquire about membership in the Secret Army Organization seem to have an idea that they will be immediately accepted into an active unit. Look at it this way. Suppose you had spent a year or more carefully recruiting and training until you had a hard hitting team where every individual was reliable, dedicated, and had confidence in his fellow unit members. Wouldn't it make you mad to have the national or regional organization assign some rank amateur to your unit that you you knew little or nothing about?

Before any new member is assigned to an active unit or to an important underground project, he must undergo a period of training. During this training he will be directed through the mails by an experienced member and some of his activities may be observed by other members without his knowledge. Only when a new member proves himself to be conscientious, trustworthy, self-disciplined and able to operate effectively alone will he be accepted as a "secure member" and invited to participate with other unit members in a teamwork operation.

## EXPENSES

Unfortunately, most good things don't come cheap. Although we make every effort to keep down the expense of membership in the Secret Army Organization, you must expect to pay your own way.

Dues to the Secret Army Organization are \$3.00 per month. This money is absolutely necessary for use to maintain our central files and headquarters, for postage and printing, to finance our extensive intelligence network, and to maintain training areas.

Each member will have other expenses depending on the type of activity he is engaged in. Every member will be expected to buy his own gun, ammunition and other basic combat equipment. During training the new member may be expected to buy certain books or subscribe to certain magazines that his work requires. During this time the new member will also be supplied with reading material on the strategy and tactics of guerrilla warfare. This home work will make it possible for him to fit in quickly to an active unit and participate effectively in actual maneuvers, marksmanship training, etc.

Following this preliminary training a member may be either assigned to an existing unit, assisted in organizing his own unit if he has shown sufficient leadership qualities or become part of an underground network.

Upon your acceptance into the Secret Army Organization you will be given a definite series of projects described in writing so you will know exactly what will be expected of you.

We hope that you can succeed in this effort because your country desperately needs patriots at this time.

CONFIDENTIAL

# SECRET ARMY ORGANIZATION

## APPLICATION FOR MEMBERSHIP

CONFIDENTIAL

NOTICE TO APPLICANT: All information on this form will be kept confidential. All records of members of the Secret Army Organization are stored in a way that they can be swiftly destroyed to keep them from falling into unauthorized hands.

Name \_\_\_\_\_ Sex \_\_\_\_\_ Age \_\_\_\_\_

Address \_\_\_\_\_ Marital Status \_\_\_\_\_  
(Street)

State \_\_\_\_\_ Wife's Name \_\_\_\_\_

Zip Code \_\_\_\_\_ Telephone \_\_\_\_\_

Date of Birth \_\_\_\_\_  
(Month) (Day) (Year)

Occupation \_\_\_\_\_ Education \_\_\_\_\_

Special Subjects Studied \_\_\_\_\_

Do You Speak or Read Any Foreign Language? \_\_\_\_\_

Veteran \_\_\_\_\_ Branch \_\_\_\_\_ Highest Rank \_\_\_\_\_

What Service Training Have You Had That You Feel Would Be Beneficial To This Organization? \_\_\_\_\_

Physical Description: Height \_\_\_\_\_ Weight \_\_\_\_\_ Color Eyes \_\_\_\_\_

Color Hair \_\_\_\_\_ Health: Good \_\_\_\_\_ Fair \_\_\_\_\_ Poor \_\_\_\_\_

Any Physical Disabilities or Limitations? \_\_\_\_\_

Any Public Speaking or Organizing Experience? \_\_\_\_\_ If Yes, Please Explain: \_\_\_\_\_

How Many Hours A Week Could You Devote To Working And Training With the S. A. O. ?

Hours \_\_\_\_\_ Best Time: AM \_\_\_\_\_ PM \_\_\_\_\_ Weekdays \_\_\_\_\_ Weekends \_\_\_\_\_

### CERTIFICATION

I am a loyal American Citizen dedicated to the defense and survival of the United States as a Constitutional Republic, free from all socialist and communist policies. Enclosed is my \$5.00 membership fee. I agree to pay \$3.00 each month to the Secret Army Organization as membership dues.

CONFIDENTIAL

Signature of Applicant \_\_\_\_\_ Date \_\_\_\_\_

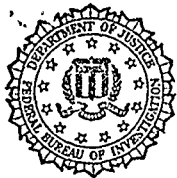

UNITED STATES DEPARTMENT OF JUSTICE  
FEDERAL BUREAU OF INVESTIGATION

Phoenix, Arizona

October 22, 1971

In Reply, Please Refer to  
File No.

Title           SECRET ARMY ORGANIZATION

Character

Reference       Memorandum, dated and captioned  
                  as above, at Phoenix, Arizona.

All sources (except any listed below) whose identities are concealed in referenced communication have furnished reliable information in the past.

This document contains neither recommendations nor conclusions of the FBI. It is the property of the FBI and is loaned to your agency; it and its contents are not to be distributed outside your agency.